

400 Series Pressure and Differential Pressure Switches

Types: **H400, H402, H403,
H400K, H402K, J400, J402,
J403, J400K, J402K**



UNITED ELECTRIC
CONTROLS

Installation and Maintenance Instructions

Please read all instructional literature carefully and thoroughly before starting. Refer to the final page for the listing of Recommended Practices, Liabilities and Warranties.

GENERAL



BEFORE INSTALLING, CHECK THE SENSOR MODEL SELECTED FOR COMPATIBILITY TO THE PROCESS MEDIA IN CONTACT WITH THE SENSOR AND WETTED PARTS.

The 400 Series pressure and differential pressure switches are activated when a bellows, diaphragm or piston sensor responds to a pressure change. This response, at a pre-determined set point, actuates one, two or three snap-acting switch(es), converting the pressure signal into an electrical signal. Control set point may be varied by turning the internal knob and pointer (H types) or internal screw (J types). (See Adjustment -PART II)



PROOF PRESSURE* LIMITS STATED IN THE LITERATURE AND ON NAMEPLATES MUST NEVER BE EXCEEDED, EVEN BY SURGES IN THE SYSTEM. OCCASIONAL OPERATION OF UNIT UP TO PROOF PRESSURE IS ACCEPTABLE (E.G., START-UP, TESTING). CONTINUOUS OPERATION SHOULD NOT EXCEED THE DESIGNATED OVER RANGE** OR WORKING PRESSURE RANGE***.

*PROOF PRESSURE - THE MAXIMUM PRESSURE TO WHICH A PRESSURE SENSOR MAY BE OCCASIONALLY SUBJECTED, WHICH CAUSES NO PERMANENT DAMAGE (E.G., START-UP, TESTING). THE UNIT MAY REQUIRE RE-GAPPING.

**OVER RANGE PRESSURE - THE MAXIMUM PRESSURE TO WHICH A PRESSURE SENSOR MAY BE CONTINUOUSLY SUBJECTED WITHOUT CAUSING DAMAGE AND MAINTAINING SET POINT REPEATABILITY.

***WORKING PRESSURE RANGE - THE PRESSURE RANGE WITHIN WHICH TWO OPPOSING SENSORS CAN BE SAFELY OPERATED AND STILL MAINTAIN SET POINT REPEATABILITY.



THESE PRODUCTS DO NOT HAVE ANY FIELD REPLACEABLE PARTS.

Please refer to product bulletin for product specifications. Product bulletins may be found at www.ueonline.com

Part I - Installation

Tools Needed

Screwdriver
Hammer (for alternate wire knockouts)
Adjustable wrench

MOUNTING



ALWAYS LOCATE UNITS WHERE SHOCK, VIBRATION AND TEMPERATURE FLUCTUATIONS ARE MINIMAL. DO NOT MOUNT UNIT IN AMBIENT TEMPERATURES EXCEEDING PUBLISHED LIMITS.



UNIT MAY BE MOUNTED IN ANY POSITION PROVIDED THE ELECTRICAL CONDUIT IS NOT FACING UP. THE RECOMMENDED MOUNTING POSITION IS VERTICAL (PRESSURE CONNECTION FACING DOWN), SPECIFICALLY WHERE HEAVY CONDENSATION IS EXPECTED.

400 Series pressure controls can be mounted in any position, provided the electrical conduit is not facing up. The preferred mounting position is vertical (pressure connection down).

A 3/4" NPT E/C is provided on the right side of the enclosure in addition to the two (2) cast-in 7/8" diameter knockouts for 1/2" electrical conduit that are located on the left side and rear of the enclosure. These can easily be knocked out by placing the blade of a screwdriver in the groove and tapping sharply with a hammer.

Mount the unit via the (2) 1/4" screw clearance holes on the enclosure. See Dimensions. Units may also be mounted via the NPT pressure connection.



ALWAYS HOLD A WRENCH ON THE PRESSURE HOUSING HEX WHEN MOUNTING UNIT. DO NOT TIGHTEN BY TURNING ENCLOSURE. THIS WILL DAMAGE SENSOR AND WEAKEN SOLDER OR WELDED JOINTS.

On models supplied with an external manual reset button, be sure to leave sufficient finger space over the reset button for the operator to reset the control.

WIRING



DISCONNECT ALL SUPPLY CIRCUITS BEFORE WIRING UNIT. WIRE UNITS ACCORDING TO NATIONAL AND LOCAL ELECTRICAL CODES. MAXIMUM RECOMMENDED WIRE SIZE IS 14 AWG. THE RECOMMENDED TIGHTENING TORQUE FOR FIELD WIRING TERMINALS IS 7 TO 17 IN-LBS.



ELECTRICAL RATINGS STATED IN LITERATURE AND ON NAMEPLATE SHOULD NEVER BE EXCEEDED. OVERLOAD ON A SWITCH CAN CAUSE FAILURE ON THE FIRST CYCLE.

Connect conduit to the case and wire directly to the switch terminals according to local and national electrical codes. Bring the wires up to terminals from the rear of the case. (See fig. 1.) If manual reset switch or DPDT options are used, lead wires are supplied, color coded as follows:

Manual Reset Option 1530 (for 400 & 400K)		Manual Reset Option 1530 (for 402 & 402K)	
	Switch 1	Switch 1	Switch 2
C	Violet	Violet	Yellow
NO	Blue	Blue	Orange
NC	Black	Black	Red

DPDT Option 1010 (for 400 & 400K)			
	Circuit 1		Circuit 2
C	Yellow		Violet
NO	Red		Blue
NC	Orange		Black

DPDT Option 1010 (for 402 & 402K)				
	Switch 1		Switch 2	
	Circuit 1	Circuit 2	Circuit 1	Circuit 2
C	White	Violet	Yellow	Blue
NC	**	**	**	**
NO	Black	Red	Orange	Brown

** On dual switch units (402 & 402K), the DPDT option is factory wired common and normally open per the color coding above. If normally closed wiring is desired, simply move the supplied wires from the normally open terminals to the normally closed terminals.

 ALLOW ENOUGH SLACK SO AS NOT TO AFFECT SWITCH MOVEMENT WHEN MAKING SETTING ADJUSTMENTS AND ENSURE THAT THE WIRES ARE NOT TOUCHING THE COVER WHEN INSTALLED.

NOTE: For larger wire gauges, a one time shift may be experienced or expected due to space limitations within the enclosure. Verify set point after installation.

NOTE: The middle switch assembly is omitted for dual switch controllers. The outer switch assemblies are omitted for single switch controllers. Type "J" controls have internal screw adjustments and type "H" have cam assemblies for internal calibrated adjustments.

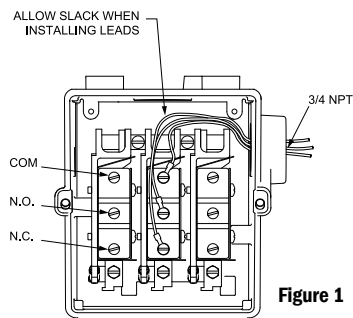

Figure 1

Special Instructions For Vacuum Ranges

On vacuum ranges, the C-NO circuit is closed at sea level conditions. Therefore, increasing vacuum will cause the C-NC circuit to close while decreasing vacuum will cause the C-NO circuit to close. Please make a note of this and wire/adjust the unit accordingly.

Part II - Adjustments (See Figure 2)

Tools Needed
Screwdriver

NOTE: For set point adjustments and re-calibration, connect control to a calibrated pressure gauge.

Type J400 & J400K

Remove cover. Switch has screw adjustments inside enclosure. Increase gauge pressure until switch transfers. To RAISE the pressure setting turn the screw clockwise (left). To LOWER the pressure setting turn the screw counter-clockwise (right). When making adjustments, do not exceed the proof pressure* rating on nameplate.

*Subjecting the switch to proof pressure may cause a shift in set point

Types J402, J403 & J402K

Remove cover, follow same procedure as paragraph above. Switches may be set together or apart, up to 100% of range (maximum separation on models 520-535 and 570-572 is defined in Table 1). On dual switch, either switch may be set high. On triple switch models, the third (middle) switch has no over-travel mechanism and must always be set to the highest pressure when switches are set apart. Altering the setting of one switch will usually have little effect on the other(s), however re-calibration may be desired at a critical pressure setting.

Table 1

Model & Range	Switch Separation (% of Range Span)
520, 530 (-300 to 0 VAC)	30%
521, 531 (-10 to 10 "wc)	50%
522, 532 (-50 to 50 "wc)	50%
523, 533 (0.5 to 5 "wc)	50%
524, 534 (2.5 to 50 "wc)	50%
525, 535 (10 to 250 "wc)	30%
570-572 (0 up to 100 psi)	30%

RE-CALIBRATION ADJUSTMENT

Special Instructions for Models 520-535 (see Figure 3)

When making set point adjustments, or re-calibrating the Models 520-535, Switch #2 should be set first, and to the highest pressure setting. Switch #1 should be set to a lower or equal setting than switch #2.

Switch #2 can be adjusted using a screwdriver to turn the slotted adjustment screw (see Figure 3) clockwise (to raise the pressure setting), or counter-clockwise (to lower the pressure setting). Once desired set point is achieved for switch #2, switch #1 can be set lower or equal to switch #2 set point, following the procedure outlined for switch #2. Maximum separation between switch #1 and #2 is defined in Table 1.

Types H400, H402, H403, H400K & H402K

Remove cover, switch has knob and pointer adjustment inside enclosure. Controls are factory calibrated for maximum accuracy at the dial midpoint. Switches may be set together or apart up to 100% of the range scale. On dual switch models either switch may be set high. On triple switch models, the third (middle) switch has no over-travel mechanism and must always be set to the highest pressure when the switches are set apart. Altering the setting of one switch will usually have little effect on the other(s), however re-calibration may be desired at a critical setting.

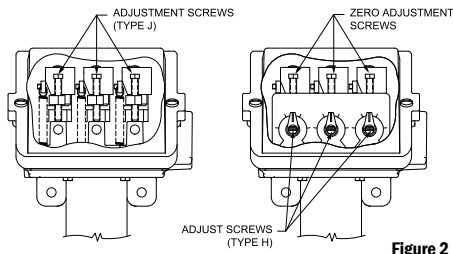

Figure 2

To re-calibrate, turn pointer to desired set point and add gauge pressure until switch transfers. If gauge pressure and set point pressure do not agree, turn zero adjust screw clockwise to raise and counter clockwise to lower pressure setting (See Figure 2).

Types with Manual Reset (Option 1530)

These optional models incorporate a snap switch that, when actuated, remains activated until pressure decreases and the reset button (located on top of the control) is manually depressed to the reset position.

Types with Adjustable Deadband Switch (Option 1520)

Models with option code 1520 incorporate a snap switch with integral adjustment wheel. Turning this wheel raises or lowers the pressure rise set point. The fall set point remains constant. To use the adjustable deadband switch:

1. Determine set point and deadband values. For example, a rising set point of 20 psi with a deadband value of 6 psi.
2. Set the falling set point at desired deadband value (determined by subtracting the deadband value from the desired set point) using the standard adjustment screw as outlined above. Using the example from step 1, $20 - 6 = 14$, so you would set the fall set point at 14 psi. This is your constant.
3. Set your deadband by turning the adjustment wheel left to raise or right to lower the set point. Using the example from step 1, turn the wheel left or right until 20 psi is achieved. This is your set point.

Consult UE for additional information.

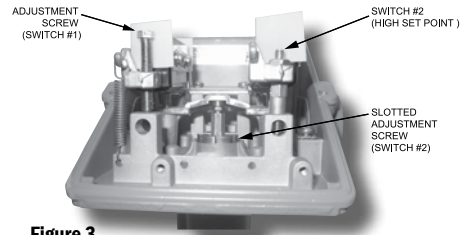

Figure 3

Types J400K & J402K with Option M210 (see Figure 4)

To adjust for maximum accuracy at any desired set point, follow steps 1 - 4:

Span Adjustment

1. Remove front window and gasket (four screws) to gain access to span adjustment.
2. Connect control to calibrated pressure source and set to required differential pressure.
3. Using a screwdriver, carefully turn span adjustment. (See Figure 4) to obtain required indication.
4. Reattach front gasket and window.

Option M210 - Differential Pressure Indication

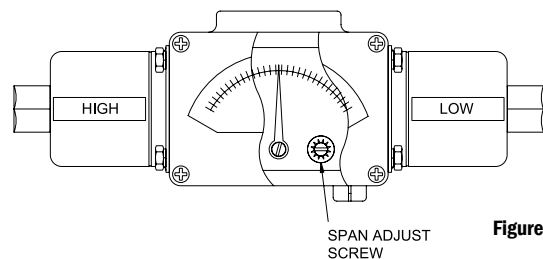
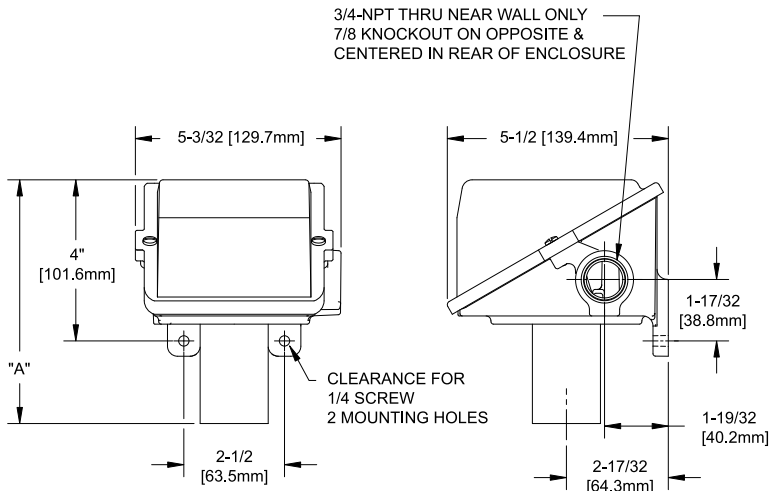

Figure 4

Dimensions

Dimensional drawings for all models may be found at www.ueonline.com



Surface Mounting Hardware Kit Part Number 6361-704 & Option M449

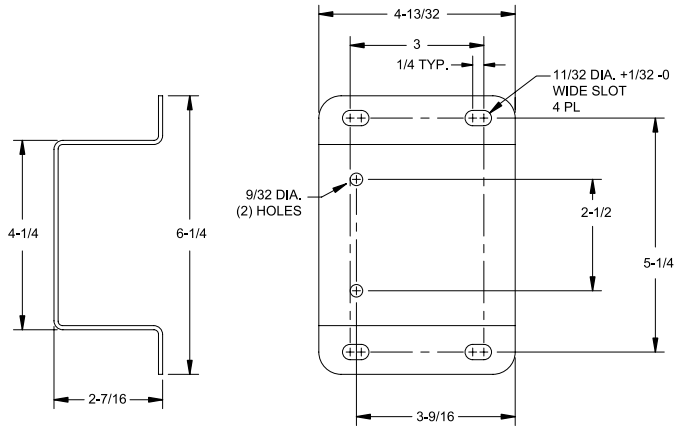

Dimension A

Models	Inches	mm	NPT
Pressure			
126-164	5.80	147.3	1/4
S126B-S164B	6.21	157.7	1/2
270-376	5.50	139.7	1/4
440-443, 449			
451, 453, 454	4.28	108.7	1/4
448, 450, 452	5.03	127.8	1/4
520-525	8.25	209.6	1/2
530-535	8.13	206.5	1/2
551, 553-555	4.56	115.8	1/4
550, 552	5.03	127.8	1/4
570-572	4.56	115.8	1/4
610-614	6.31	160.3	1/4

Differential Pressure

147-157	6.13	155.7	1/4
S147B-S157B	6.13	155.7	1/2
455-559	7.00	177.8	1/4
540-543	7.97	202.4	1/8
544-547	8.03	204.0	1/8

Pressure Sensors

Models 126-164

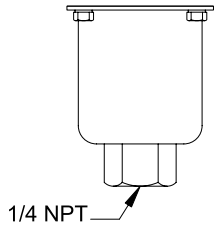

Models S126B-S164B

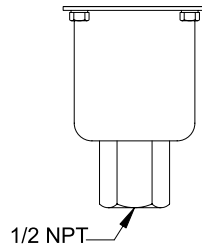

Models 270-376

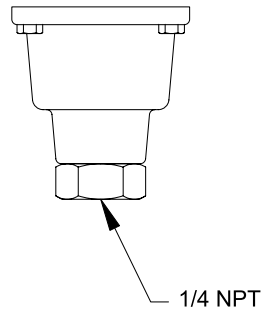

Models 440-454,
550-555, 570-572

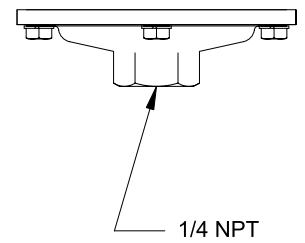

Models 610-614

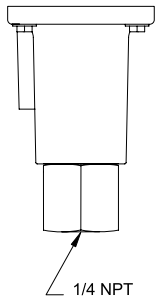

Models 520-525

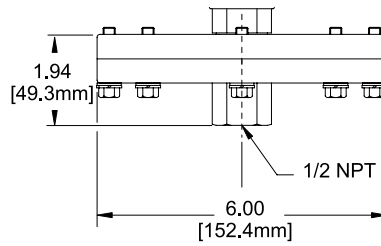

Models 530-535

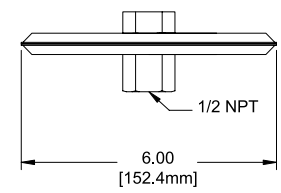

Differential Pressure Sensors

Models 147-157

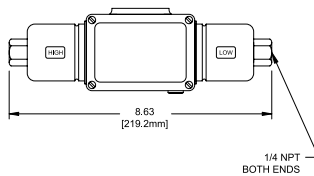

Models 544-547

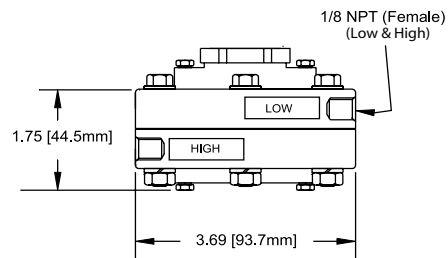

Models S147B-S157B

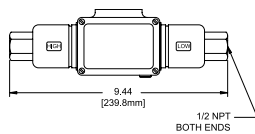

Models 455-559

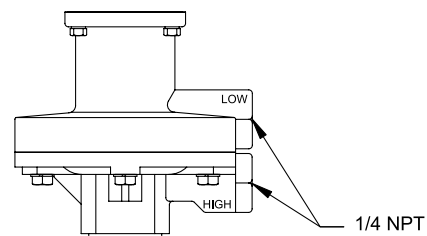

Models 540-543

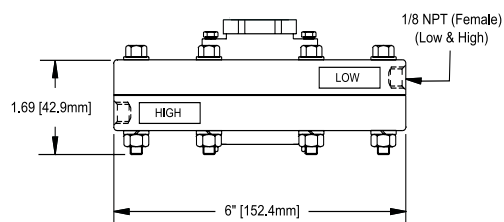

RECOMMENDED PRACTICES AND WARNINGS

United Electric Controls Company recommends careful consideration of the following factors when specifying and installing UE pressure and temperature units. Before installing a unit, the Installation and Maintenance instructions provided with unit must be read and understood.

- To avoid damaging unit, proof pressure and maximum temperature limits stated in literature and on nameplates must never be exceeded, even by surges in the system. Operation of the unit up to maximum pressure or temperature is acceptable on a limited basis (e.g., start-up, testing) but continuous operation must be restricted to the designated adjustable range. Excessive cycling at maximum pressure or temperature limits could reduce sensor life.
- A back-up unit is necessary for applications where damage to a primary unit could endanger life, limb or property. A high or low limit switch is necessary for applications where a dangerous runaway condition could result.
- The adjustable range must be selected so that incorrect, inadvertent or malicious setting at any range point cannot result in an unsafe system condition.
- Install unit where shock, vibration and ambient temperature fluctuations will not damage unit or affect operation. When applicable, orient unit so that moisture does not enter the enclosure via the electrical connection. When appropriate, this entry point should be sealed to prevent moisture entry.
- Unit must not be altered or modified after shipment. Consult UE if modification is necessary.
- Monitor operation to observe warning signs of possible damage to unit, such as drift in set point or faulty display. Check unit immediately.
- Preventative maintenance and periodic testing is necessary for critical applications where damage could endanger property or personnel.
- Electrical ratings stated in literature and on nameplate must not be exceeded. Overload on a switch can cause damage, even on the first cycle. Wire unit according to local and national electrical codes, using wire size recommended in installation sheet.
- Do not mount unit in ambient temp. exceeding published limits.

LIMITED WARRANTY

Seller warrants that the product hereby purchased is, upon delivery, free from defects in material and workmanship and that any such product which is found to be defective in such workmanship or material will be repaired or replaced by Seller (Ex-works, Factory, Watertown, Massachusetts. INCOTERMS); provided, however, that this warranty applies only to equipment found to be so defective within a period of 24 months from the date of manufacture by the Seller. Seller shall not be obligated under this warranty for alleged defects which examination discloses are due to tampering, misuse, neglect, improper storage, and in any case where products are disassembled by anyone other than authorized Seller's representatives. EXCEPT FOR THE LIMITED WARRANTY OF REPAIR AND REPLACEMENT STATED ABOVE, SELLER DISCLAIMS ALL WARRANTIES WHATSOEVER WITH RESPECT TO THE PRODUCT, INCLUDING ALL IMPLIED WARRANTIES OF MERCHANTABILITY OR FITNESS FOR ANY PARTICULAR PURPOSE.

LIMITATION OF SELLER'S LIABILITY

Seller's liability to Buyer for any loss or claim, including liability incurred in connection with (i) breach of any warranty whatsoever, expressed or implied, (ii) a breach of contract, (iii) a negligent act or acts (or negligent failure to act) committed by Seller, or (iv) an act for which strict liability will be inputed to seller, is limited to the "limited warranty" of repair and/or replacement as so stated in our warranty of product. In no event shall the Seller be liable for any special, indirect, consequential or other damages of a like general nature, including, without limitation, loss of profits or production, or loss or expenses of any nature incurred by the buyer or any third party.

UE specifications subject to change without notice.



UNITED ELECTRIC
CONTROLS

180 Dexter Avenue, P.O. Box 9143
Watertown, MA 02471-9143 USA
Telephone: 617 926-1000 Fax: 617 926-2568
<http://www.ueonline.com>