

Radar Transmitters

SITRANS LR460 (HART/PROFIBUS PA)

Quick Start Manual · 03/2013



SITRANS

SIEMENS

SITRANS LR460 Quick Start Manual

This manual outlines the essential features and functions of the SITRANS LR460. We strongly advise you to acquire the detailed version of the manual so you can use your instrument to its fullest potential. The complete manual is available from the product page of our website at: <https://pia.khe.siemens.com/index.asp?Nr=14655>. Questions about the contents of this manual can be directed to:

Siemens Milltronics Process Instruments
1954 Technology Drive, P.O. Box 4225
Peterborough, Ontario, Canada, K9J 7B1
Email: techpubs.smpi@siemens.com

**Copyright Siemens Milltronics
Process Instruments 2013.
All Rights Reserved**

Disclaimer of Liability

We encourage users to purchase authorized bound manuals, or to view electronic versions as designed and authored by Siemens Milltronics Process Instruments. Siemens Milltronics Process Instruments will not be responsible for the contents of partial or whole reproductions of either bound or electronic versions.

While we have verified the contents of this manual for agreement with the instrumentation described, variations remain possible. Thus we cannot guarantee full agreement. The contents of this manual are regularly reviewed and corrections are included in subsequent editions. We welcome all suggestions for improvement.

Technical data subject to change.

MILLTRONICS is a registered trademark of Siemens Milltronics Process Instruments.

Technical Support

Support is available 24 hours a day.

To find your local Siemens Automation Office address, phone number, and fax number, go to:

www.siemens.com/automation/partner:

- Click on the tab **Contacts by Product** then find your product group (**+Process Automation > +Process Instrumentation > +Level Measuring Instruments**).
- Select the team **Technical Support**. Click on **Next**.
- Click on a continent, then a country, followed by a city. Click on **Next**.

For on-line technical support go to: www.siemens.com/automation/support-request

- Enter the device name (SITRANS LR460) or order number, then click on **Search**, and select the appropriate product type. Click on **Next**.
- Enter a keyword describing your issue. Then either browse the relevant documentation, or click on **Next** to email a description of your issue to Siemens Technical Support staff.

Siemens A&D Technical Support Center: phone +49 180 50 50 222 fax +49 180 50 50 223+

Safety Guidelines

Warning notices must be observed to ensure personal safety as well as that of others, and to protect the product and the connected equipment. These warning notices are accompanied by a clarification of the level of caution to be observed.



WARNING: relates to a caution symbol on the product, and means that failure to observe the necessary precautions can result in death, serious injury, and/or considerable material damage.



WARNING¹: means that failure to observe the necessary precautions can result in death, serious injury, and/or considerable material damage.

Note: means important information about the product or that part of the operating manual.

¹ This symbol is used when there is no corresponding caution symbol on the product.

FCC and IC Conformity

US Installations only: Federal Communications Commission (FCC) rules



WARNING: Changes or modifications not expressly approved by Siemens Milltronics could void the user's authority to operate the equipment.

Notes:

- This equipment has been tested and found to comply with the limits for a Class A digital device, pursuant to Part 15 of the FCC Rules. These limits are designed to provide reasonable protection against harmful interference when the equipment is operated in a commercial environment.
- This equipment generates, uses, and can radiate radio frequency energy and, if not installed and used in accordance with the instruction manual, may cause harmful interference to radio communications. Operation of this equipment in a residential area is likely to cause harmful interference to radio communications, in which case the user will be required to correct the interference at his own expense.

Canadian Installations only: Industry Canada (IC) rules

Notes:

- This device shall be installed and operated in a completely enclosed container to prevent RF emission, which otherwise can interfere with aeronautical navigation. Installation shall be done by trained installers, in strict compliance with the manufacturer's instructions.
- The use of this device is on a 'no-protection non-interference' basis.
 - The user shall accept operations of high powered radar in the same frequency band, which may interfere with or damage this device.
 - The user is responsible for removing, at the user's expense, any device found to interfere with primary licensing operations.

The Manual

SITRANS LR460 supports HART communication protocol, or PROFIBUS PA, and SIMATIC PDM software, and this manual is in 3 parts:

- *SITRANS LR460 (HART/PROFIBUS PA)* on page 3: information for both HART/PROFIBUS PA models, including:
 - power, approvals, installation, connecting, programming, activating, quick start via handheld programmer, communications via HART or PROFIBUS PA, quick start via SIMATIC PDM
- *Hazardous area installations* on page 15
- *SITRANS LR460 PROFIBUS PA wiring* on page 8

SITRANS LR460 (HART/PROFIBUS PA)

The SITRANS LR460 is a 4-wire 24 GHz FMCW radar level transmitter with extremely high signal-to-noise ratio and advanced signal processing for continuous monitoring of solids up to 100 m (328 ft). It is ideal for measurement in extreme dust. The Easy Aimer design makes it easy to install the device and orient the signal towards the material angle of repose. The high frequency signal creates a narrow emission cone, which makes the LR460 quite insensitive to vessel interferences.

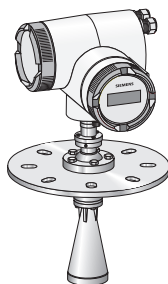

Specifications

For a complete listing, see the SITRANS LR460 Instruction Manual, available from the product page of our website at: <https://pia.khe.siemens.com/index.asp?Nr=14655>. For Approvals information, please refer to the product nameplate.

Power

- 100 to 230 V AC, $\pm 15\%$, 50/60 Hz, 6 W or 24 V DC, +25/-20%, 6 W
- Fuse (AC)
 - S11 Fast acting ceramic, 4 x 20 mm, 1 A, 250 V AC
 - S12 Slow-Blow, 4 x 20 mm, 0.63 A, 250 V AC
- Fuse (DC)
 - S11 Fast acting ceramic, 4 x 20 mm, 2 A, 250 V AC
 - S12 Slow-Blow, 4 x 20 mm, 0.63 A, 250 V AC

Approvals (verify against device nameplate)

Hazardous areas	FM/CSA: Class II, Div. 1, Groups E, F and G, Class III ATEX II 1 D, 1/2 D, 2D Ex tD A20 IP67 T85 °C INMETRO: DNV 12.0089 X Ex tb IIIC T85 °C Db IP67 -40 °C ≤ Ta ≤ +65 °C DNV #OCP 0017 ABNT NBR IEC 60079-0:2008 e ABNT NBR IEC 60079-31:2011
General	CSAUS/C, FM, CE, C-Tick
Radio	FCC, Industry Canada, European Radio (R&TTE), C-Tick

Installation

! WARNING: SITRANS LR460 is to be used only in the manner outlined in this manual, otherwise protection provided by the equipment may be impaired. Installation shall only be performed by qualified personnel and in accordance with local governing regulations.

Notes:

- For European Union and member countries, installation must be according to ETSI EN 302372.
- Refer to device nameplate for approval information.
- Use appropriate conduit and conduit fittings or cable glands, to maintain IP or NEMA rating.
- Observe maximum permissible ambient and process temperatures.
- For US and Canadian installations, see FCC and IC Conformity on page 2.

Mounting location

Notes:

- Provide easy access for viewing the display and programming via the handheld programmer.
- Provide an environment suitable to the housing rating and materials of construction.
- Provide a sun shield if the device is mounted in direct sunlight.

Key considerations

- Nozzle design and nozzle location are critical to a successful application.
- Avoid reflective interference from vessel walls and obstructions by following the guidelines below.

Nozzle design

- Bottom edge of horn must project from nozzle.
- Nozzle must have adequate clearance to allow LR460 to be positioned at an angle (see *Device orientation* below).

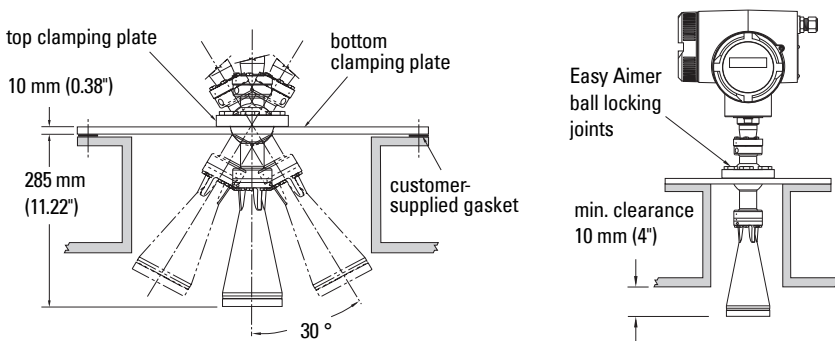

Nozzle location

- Locate antenna at least 1 meter away from side wall.
- Keep emission cone free of interference from ladders, pipes, I-beams or filling streams.
- Make allowance for beam spread to avoid interference with the emission cone.

Device orientation

Align the antenna so that the radar cone is perpendicular to the surface of the monitored material, if possible.

Easy Aimer Installation

Note: When the Easy Aimer ball is loosened, the device is free to tilt to a maximum of 30°.

1. Holding the electronics enclosure firmly, loosen the Easy Aimer ball locking bolts and gently reposition the enclosure (see *Nozzle design* above).
2. Direct SITRANS LR460 so the horn antenna is pointed at an angle perpendicular to the material surface, if possible. (As a guide, aim the beam at a point approximately 2/3 of the way across the tank diameter.)
3. When the desired position is reached, re-tighten the 5 bolts to 15-23 N m (11 to 17 Lbf-ft).

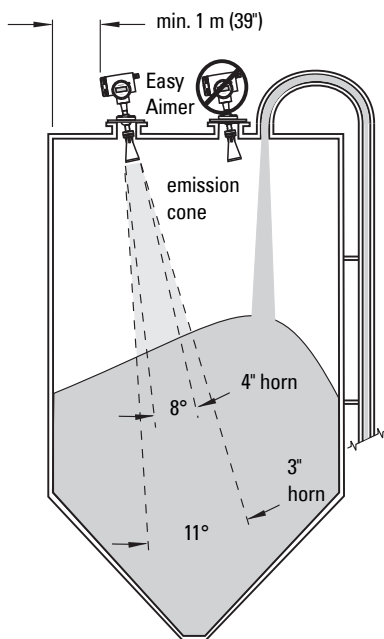

Wiring

! WARNINGS:

- Turn off power to the device before removing the cover in a hazardous area.
- All field wiring for AC models must have insulation suitable for at least 250 V.
- The DC input terminals shall be supplied from a source that provides electrical isolation between the input and the output, in order to meet the applicable safety requirements of IEC 61010-1.
- The equipment shall be protected by a fuse or circuit breaker of up to 16 A in the building installation.
- A circuit breaker or switch in the building installation, marked as the disconnect switch, shall be in close proximity to the equipment and within easy reach of the operator.
- To avoid short-circuits, do not connect a load resistance with bare wires inside the connection box.

Notes:

- AC and DC input circuits: min. 14 AWG (2.5 sq. mm) copper wire.
- Lay power cables separately from communication wiring.
- Recommended torque on terminal clamping screws: 0.5 to 0.6 N m (0.37 to 0.44 Lbf-ft).

Connecting SITRANS LR460

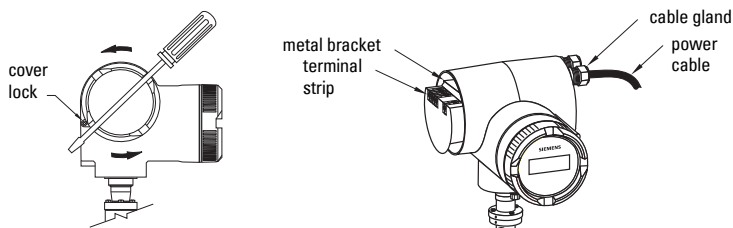

1. Release the cover lock on the enclosure with a 3 mm Allen key and unscrew the cover. (Use a screwdriver for extra leverage, if required.)
2. Loosen the cable gland and push the power cable through until it reaches the terminal strip.
3. Go to *SITRANS LR460 HART wiring* on page 7 or *SITRANS LR460 PROFIBUS PA wiring* on page 8 for next steps.

SITRANS LR460 HART wiring

(continued from *Connecting SITRANS LR460* on page 6)

Note: LR460 HART requires no power from the 4-20 mA loop.

Install in accordance with *Wiring and Installation* in the HART Application Guide (order number HCF_LIT-34), available from: <http://www.hartcomm.org/technical/doclist.html>.

AC version

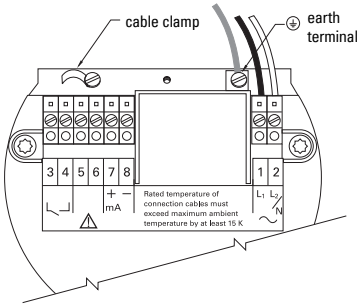

DC version

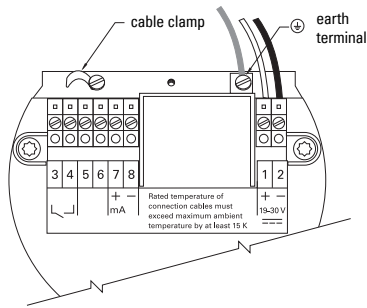

Connecting HART

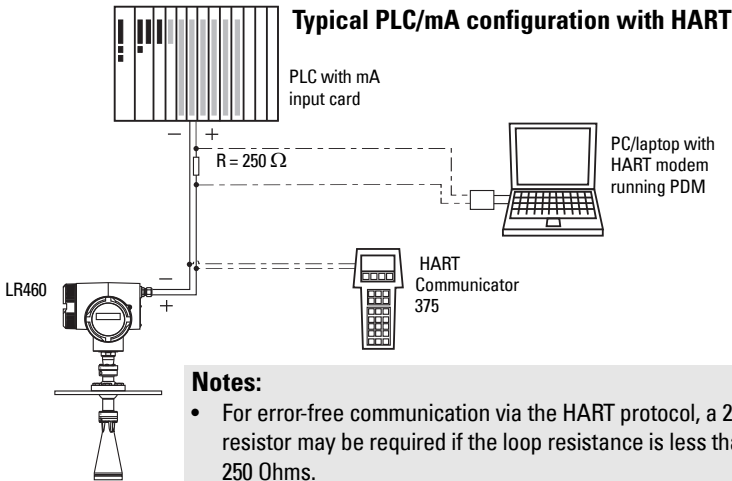

4. Connect the earth conductor of the power supply to the earth terminal  on the metal bracket inside the enclosure. Adjust the cable length so that the earth conductor would be last to disconnect if cable is pulled.
5. Tighten the cable gland and check the strain relief (pull and turn).

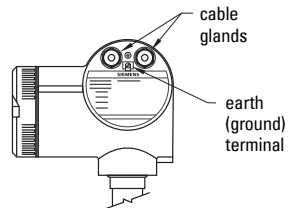

6. Replace the enclosure cover and hand tighten it. The sealing ring must be clean and undamaged.
7. Tighten the screw on the cover lock.
8. Connect the external earth terminal located between the cable glands to a ground connection at your vessel. Use a cable with a cross-section of 2.5 mm² or greater.
9. Return to *SITRANS LR460 HART wiring* on page 7 to complete LR460 set up.

SITRANS LR460 PROFIBUS PA wiring

(continued from *Connecting SITRANS LR460* on page 6)

Note: PROFIBUS PA is not polarity-sensitive.

Power Demands

To determine how many devices can be connected to a bus line, calculate the combined maximum current consumption of all the connected devices: 10.5 mA for SITRANS LR460. Allow a current reserve for safety.

Bus Termination

PROFIBUS PA **MUST** be terminated at both extreme ends of the cable for it to work properly. Please refer to the PROFIBUS PA User and Installation Guidelines (order number 2.092), available from www.profibus.com.

Install in accordance with *PROFIBUS PA User and Installation Guidelines* (order number 2.092), available from www.profibus.com.

AC version

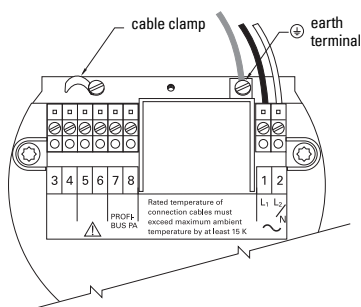

DC version

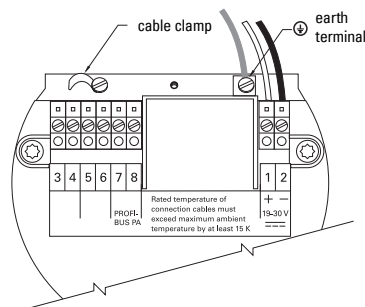

Connecting PROFIBUS PA

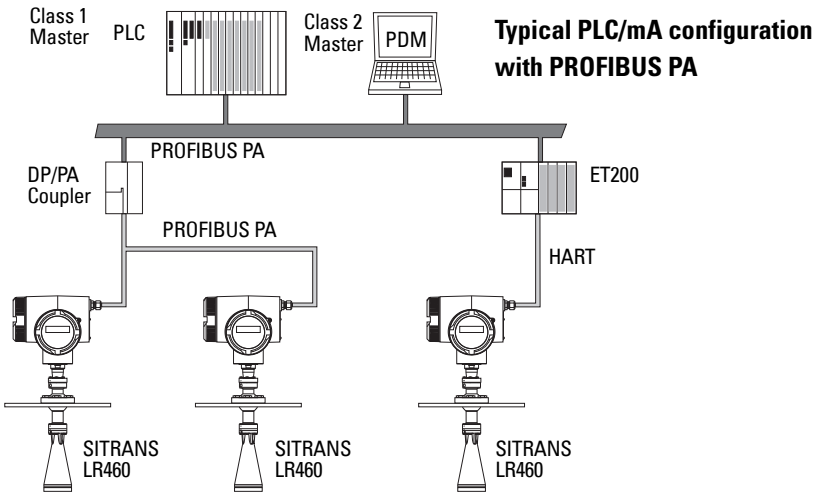

- Connect the earth conductor of the power supply to the earth terminal  on the metal bracket inside the enclosure. Adjust the cable length so that the earth conductor would be last to disconnect if cable is pulled.
- Tighten the cable gland and check the strain relief (pull and turn).
- Replace the enclosure cover and hand tighten it. The sealing ring must be clean and undamaged.
- Tighten the screw on the cover lock.
- Connect the external earth terminal located between the cable glands to a ground connection at your vessel. Use a cable with a cross-section of 2.5 mm² or greater.
- Return to *SITRANS LR460 HART wiring* on page 7 to complete LR460 set up.

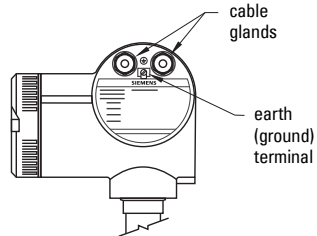

Programming SITRANS LR460

Note: SITRANS LR460 only supports SIMATIC PDM version 6.0 with SP2 HF1 (or higher).

To set up SITRANS LR460 for a simple application requires only the following settings:

- select application type (silo construction)
- select operation mode: level, distance or space
- set speed of response
- set high and low calibration points

A Quick Start Wizard groups together all the settings you need. There are two ways to access the wizard:

- *Quick Start Wizard via the handheld programmer* on page 10
- *Quick Start Wizard via SIMATIC PDM* on page 13

Activating SITRANS LR460

Notes:

- Keep infrared devices such as laptops, cell phones, and PDAs, away from SITRANS LR460 to prevent inadvertent operation.
- Frequently switching the device off and on causes wear of the electronics. For details, see the full manual.

Power up the instrument. SITRANS LR460 automatically starts up in **RUN** mode, and detects the distance to the material level referenced from the sensor flange face. The LCD displays the measurement and the default unit is meters. System status is displayed on the LCD, or on a remote communications terminal.

RUN mode display

Normal operation

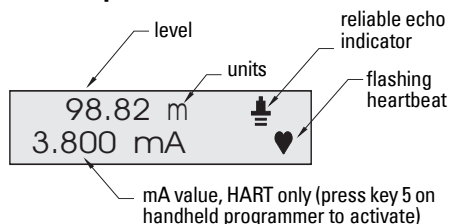

LOE condition

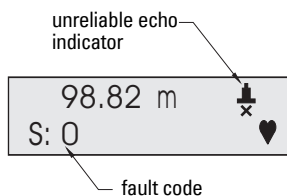

Quick Start Wizard via the handheld programmer

Notes:



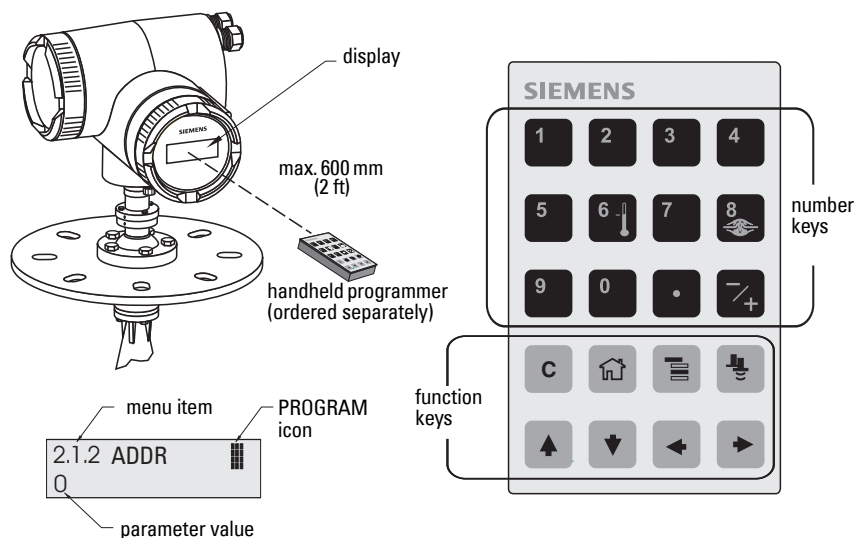

- The wizard is a complete package and the settings are inter-related.
- Do not use the Quick Start Wizard to modify individual parameters. See the full manual for detailed instructions.
- Changes apply only after you select **YES** in parameter 1.8 (APPLY?).

The Quick Start menu appears as soon as you activate **PROGRAM** mode.

Quick Start



Using the Handheld Programmer:

- Point the programmer at the display [from a maximum distance of 600 mm (2 ft.)], then press **Mode**  to activate **PROGRAM** mode and open Menu level 1.
- Press **Right ARROW**  to navigate to menu item 1.1.
- Press **Right ARROW**  to open **Edit** mode: the PROGRAM icon  will flash.
- To change a setting, scroll to the desired selection or key in a new value.
- After modifying a value, press **Right ARROW**  to accept it. The LCD displays the next menu item, the PROGRAM icon disappears, and the rightmost digit flashes to indicate **Navigation Mode**.

1.1 Language

Options	ENGLISH, DEUTSCH, FRANCAIS, ESPANOL
----------------	-------------------------------------

1.2 Application Type (APPL)

Options	STEEL	Silo construction
	CONCRETE	

1.3 Operation

Options	LEVEL	Distance to material surface referenced from low calibration point (process empty level).
	SPACE	Distance to high calibration point (process full level) referenced from material surface.
	DISTANCE	Distance to material surface referenced from sensor reference point.

Operation types

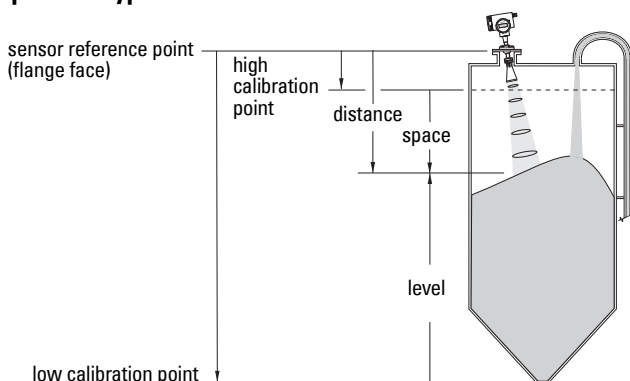

1.4 Units

Select the units for the Quick Start variables (high and low calibration point, and level, distance, or space).

Options	mm, cm, m, in, ft
----------------	-------------------

1.5 High Calibration Point (CAL HIGH)

Distance from Sensor Reference to high calibration point: usually process full level (See 1.3 Operation for an illustration).

Values	Range 0.0000 to 100.00 m
---------------	--------------------------

1.6 Low Calibration Point (CAL LOW)

Distance from Sensor Reference to low calibration point: usually process empty level (See 1.3 Operation for an illustration).

Values	Range: 0.0000 to 100.00 m
---------------	---------------------------

1.7 Rate

Sets the reaction speed of the device to measurement changes in the target range.

Options	SLOW	0.1 m/minute
	MED	1.0 m/minute
	FAST	10.0 m/minute

Use a setting just faster than the maximum filling or emptying rate (whichever is greater). Slower settings provide higher accuracy, faster settings allow for more level fluctuation.

1.8 Apply Changes (APPLY?)

*In order to save the Quick Start settings it is necessary to enable **Apply Changes**.*

Options	YES, NO
----------------	---------

Select **YES**. SITRANS LR460 is now ready to operate and returns to RUN mode.

Communication via HART or PROFIBUS PA

Notes:

- The Quick Start settings are not independent parameters. The settings are inter-related, and changes only apply when you click **Transfer** at the end of step 4.
- Do not use the Quick Start Wizard to modify individual parameters. See the full manual for detailed instructions.

Quick Start Wizard via SIMATIC PDM

The graphical Quick Start Wizard groups together all the settings you need to make for a simple application into 4 steps.

To use HART or PROFIBUS PA, you will need a PC configuration tool: we recommend SIMATIC PDM.

Please consult the operating instructions or online help for details on using SIMATIC PDM. (Application Guides for setting up SMPI HART and PROFIBUS PA instruments with SIMATIC PDM are available on our website: www.siemens.com/processautomation.)







Device Description (DD)

You will need the most up-to-date DD for SIMATIC PDM version 6.0 with SP2 HF1 (or higher). You can locate the DD in Device Catalog, under **Sensors/Level/Echo/Siemens Milltronics/SITRANS LR460**. If you do not see **SITRANS LR460** under Siemens Milltronics, you can download the DD from the product page of our website at: <https://pia.khe.siemens.com/index.asp?Nr=14655>, under **Downloads**.

Save the files to your computer, and extract the zipped file to an easily accessed location. Launch **SIMATIC PDM – Manager Device Catalog**, browse to the unzipped DD file and select it.

Configuring a new device

1. Set Address (default for PROFIBUS PA is 126; for HART is 0).
 - Point the handheld programmer at the display then press **Mode**  to activate **PROGRAM** mode, menu item 1.

- Press **Down ARROW** , **Right ARROW** , **Right ARROW**  to navigate to Address [HART: (menu item 2.1.2) or PROFIBUS PA: (menu item 2.1.1)].
 - Press **Right ARROW**  to open Edit mode: the PROGRAM icon  will flash.
 - If required, key in a new value and press **Right ARROW**  to accept it. The LCD displays the new value and the PROGRAM icon disappears.
2. Launch SIMATIC Manager and create a new project for LR460. Application Guides for setting up HART and PROFIBUS PA devices with SIMATIC PDM can be downloaded from the product page of our website at: <https://pia.khe.siemens.com/index.asp?Nr=14655>
 3. Open the menu **Device – Reset**, select **Factory Defaults** and click **OK**.
 4. After the reset is complete, upload parameters to the PC/PG.
 5. Configure the device via the Quick Start Wizard.

Quick Start Wizard via SIMATIC PDM

Open the menu **Device – Quick Start**, and follow steps 1 to 4.

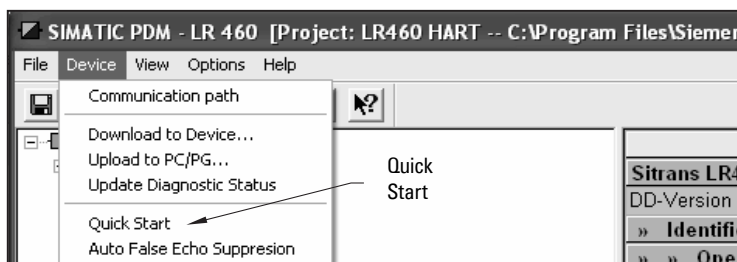

Step 1 – Identification

Click **NEXT** to accept default values. (Description, Message, and Last config fields can be left blank.)

Step 2 – Application Type

Select the application type and operation type and click **NEXT**.

Step 3 – Range Setup

Set Sensor Units, enter values for low and high calibration points, and select a response rate just faster than the maximum fill/empty rate¹. Click **NEXT**.

Step 4 – Summary

Check parameter settings, and click **BACK** to return and revise values, or **TRANSFER** to transfer values to the device.

After the values have been transferred to the device the message **Device Configuration Complete** appears. Click **OK** to upload values from the device to the PC/PG and synchronize the device and PDM.

¹ See 1.7 Rate on page 13.

Hazardous area installations

Instructions specific to hazardous area installations (Reference European ATEX Directive 94/9/EC, Annex II, 1/0/6)

Notes:

- See inside front cover for nameplate illustrations. The nameplate shown is a typical example. Please check the nameplate on your device for your specific device configuration.
- Installation shall be performed only by qualified personnel and in accordance with local governing regulations.

The following instructions apply to equipment covered by certificate number Sira 06 ATEX 9218X.

1. For use and assembly, refer to the main instructions.
2. The equipment is certified for use as Category II 1D, 1/2 D & 2D equipment. The Essential Health and Safety Requirements are assured by compliance with IEC 61241-0: 2004 and IEC 61241-1: 2004.
3. The equipment may be used with dust and fibers with apparatus temperature class T (see table below).
4. Thermal Data for 7ML5426 Series

Device category	Permitted ambient temperature at horn antenna	Permitted ambient temperature at electronic enclosure
1D, 1/2D, 2D	$-40\text{ °C } (-40\text{ °F}) \leq T_{\text{amb}} \leq +200\text{ °C } (+392\text{ °F})$	$-40\text{ °C } (-40\text{ °F}) \leq T_{\text{amb}} \leq +65\text{ °C } (+149\text{ °F})$

5. The equipment has not been assessed as a safety related device (as referred to by Directive 94/9/EC Annex II, clause 1.5).
6. Installation and inspection of this equipment shall be carried out by suitably trained personnel in accordance with the applicable code of practice (EN 61241-14 and EN 61241-17 in Europe).
7. Repair of this equipment shall be carried out by suitably trained personnel in accordance with the applicable code of practice.
8. Components to be incorporated into or used as replacements in the equipment shall be fitted by suitably trained personnel in accordance with the manufacturer's documentation.
9. It is the user's responsibility to ensure that a manual override is possible in order to shut down the equipment, and that protective systems are incorporated within automatic processes which deviate from the intended operating conditions, provided that this does not compromise safety.
10. Equipment Marking: The equipment marking contains at least the information on the product label. See product nameplate.

SPECIAL CONDITIONS FOR SAFE USE

The 'X' suffix to the certificate number relates to the following special condition(s) for safe use.

- Cable or conduit entries must meet the requirements of European Directive 94/9/EC for Group II, Category 1D, 1/2D, or 2D, as appropriate, and must maintain the overall IP rating of the enclosure.
- For applications that require the purge feature, the user shall implement a means to ensure that combustible dust from the hazardous area cannot enter the purge supply in such a way as to compromise the area classification.