

**DirectLine® DL421 Sensor Module
for Durafet® II, Durafet® III,
Meredian® II, and HPW7000 pH
Electrodes
User Manual**

70-82-25-102

Rev. 5

2/04

Notices and Trademarks

Copyright 2004 by Honeywell
February, 2004

Warranty/Remedy

Honeywell warrants goods of its manufacture as being free of defective materials and faulty workmanship. Contact your local sales office for warranty information. If warranted goods are returned to Honeywell during the period of coverage, Honeywell will repair or replace without charge those items it finds defective. The foregoing is Buyer's sole remedy and is **in lieu of all other warranties, expressed or implied, including those of merchantability and fitness for a particular purpose**. Specifications may change without notice. The information we supply is believed to be accurate and reliable as of this printing. However, we assume no responsibility for its use.

While we provide application assistance personally, through our literature and the Honeywell web site, it is up to the customer to determine the suitability of the product in the application.

CE Conformity

This product is in conformance with the protection requirements of the following European Council Directives: 89/336/EEC, the Electromagnetic Compatibility Directive and 73/23/EEC, the Low Voltage Directive. Conformance of this product with any other "CE Mark" Directive(s) shall not be assumed.

ATTENTION

The emission limits of EN 61326 are designed to provide reasonable protection against harmful interference when this equipment is operated in an industrial environment. Operation of this equipment in a residential area may cause harmful interference. This equipment generates, uses and can radiate radio frequency energy and may cause interference to radio and television reception when the equipment is used closer than 30 m to the antenna(e). In special cases, when highly susceptible apparatus is used in close proximity, the user may have to employ additional mitigating measures to further reduce the electromagnetic emissions of this equipment.

Industrial Measurement and Control

Honeywell
1100 Virginia Ave.
Fort Washington, PA 19034

DirectLine is a registered trademark of Honeywell

Durafet and Meredian are U.S. registered trademarks of Honeywell

Other brands or product names are trademarks of their respective owners

Insert 70-82-10-01 should accompany this document.

About This Document

Abstract

This manual contains all the information that is needed to install, configure, calibrate, operate, and troubleshoot the DirectLine® Sensor. Insert 70-82-10-01, a quick reference guide for configuring and calibrating the DL421, should accompany this document.

Contacts

World Wide Web

The following lists Honeywell's World Wide Web sites that will be of interest to our customers.

Honeywell Organization	WWW Address (URL)
Corporate	http://www.honeywell.com
Industrial Measurement and Control	http://www.honeywell.com/imc
International	http://www.honeywell.com/Business/global.asp



Telephone

Contact us by telephone at the numbers listed below.

Organization		Phone Number	
United States and Canada	Honeywell	1-800-423-9883	
		(215) 641-3610	<i>Tech. Support</i>
		1-888-423-9883	<i>Q&A Faxback (TACFACS)</i>
		1-800-525-7439	<i>Service</i>

Symbol Definitions

The following table lists any symbols used in this document to denote certain conditions.

Symbol	Definition
	Earth Ground. Functional earth connection. NOTE: This connection shall be bonded to Protective earth at the source of supply in accordance with national and local electrical code requirements.
	ATTENTION, Electrostatic Discharge (ESD) hazards. Observe precautions for handling electrostatic sensitive devices

Contents

1. INTRODUCTION	1
1.1 Overview	1
1.2 Electronics Module	1
1.3 Operator Interface.....	2
1.4 Specifications.....	3
1.5 Model Selection Guide	4
2. INSTALLATION	5
2.1 Assembly and Wiring.....	5
2.2 Integral Mounting	7
2.3 Remote Mounting	8
2.4 Conduit connections	13
3. CONFIGURATION	14
3.1 Overview.....	14
3.2 Configuration Set Up Procedure.....	15
4. CALIBRATION.....	18
4.1 Calibration Diagnostics	18
4.2 Calibration Diagnostic Reset	18
4.3 Calibration.....	19
4.4 Calibration in High Purity Water	22
5. OPERATION	23
5.1 Displays	23
5.2 Diagnostic Error Messages	25
5.3 Unit Reset.....	26
6. SPARE PARTS	27
7. APPENDIX: CE MARK APPLICATIONS	30
8. SALES AND SERVICE.....	32

Tables

Table 2-1 Assembly and Wiring Procedure for Field Wiring Connector	6
Table 2-2 Integral Mounting Procedure (refer to Figure 2-3)	7
Table 2-3 Remote Mounting Procedure for Durafet II and Durafet III Electrodes	8
Table 2-4 Remote Mounting Procedure for Meredian II Electrodes	9
Table 2-5 Remote Mounting Procedure for HPW7000 Electrodes	10
Table 3-1 Buffer Groups and the pH standard values	14
Table 3-2 Configuration Set Up Procedure	15
Table 4-1 Standard pH Buffer Values	20
Table 4-2 Zero (Standardization) Calibration Procedure	21
Table 4-3 Slope Calibration Procedure	22
Table 4-4 High purity water calibration Procedure	22
Table 5-1 Online Parameter Descriptions	23
Table 5-2 Display Navigation Procedure	24
Table 5-3 Online Diagnostic Errors	25
Table 5-4 Factory Default Values	26

Figures

Figure 1-1	DirectLine® Sensor	1
Figure 1-2	Electronics Module	2
Figure 2-1	Cordset Connection and Wiring	5
Figure 2-2	Field Wiring Connector	6
Figure 2-3	Integral Mounting	7
Figure 2-4	Remote Mounting	11
Figure 2-5	Remote Mounting Hardware	12
Figure 7-1	Wiring for CE Mark Applications	30

1. Introduction

1.1 Overview

The DirectLine® Sensor consists of an **electronics module** connected to a **Durafet® II, Durafet® III, Meredian® II or HPW7000 pH electrode** that eliminates the need for pre-amplifiers, transmitters, and analyzers in pH applications.

The modular electronics design can be separated from the sensor, allowing the sensor to be easily removed or replaced while retaining power to the electronics module.

The DL421 **electronics module** is contained in a Nema Type 4x polysulfone housing. The Module can be mounted as an integral unit directly connected to the electrode or remotely using an electrode with a cable. The sealed plastic housing has plug-in connections for the pH electrode and 4-20 mA cordset.

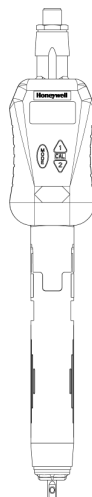

Figure 1-1 DirectLine® Sensor

1.2 Electronics Module

The electronics module is loop-powered by 16-42 Vdc and will modulate its supply current from 4 mA to 20 mA, depending upon the pH value that is sensed by the electrode. The transmitted loop current is compensated for temperature internally using the standard Honeywell 8550 thermistor.

For submersion or special wiring applications, the remote electronics module is compatible with the existing Durafet II, Meredian II or HPW7000 technology without modification. A Durafet II or Meredian II cable length is supported with direct connection to the electronics module.

A 4-20 mA output connection is provided via a 6m cordset or a customer supplied cable used in combination with a field wiring connector.

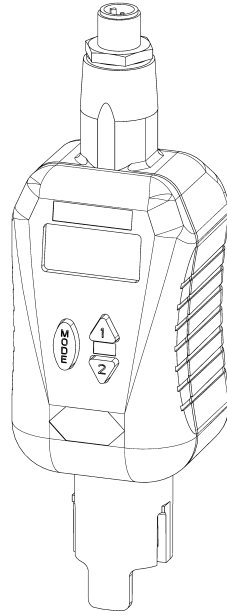

Figure 1-2 Electronics Module

1.3 Operator Interface

The DirectLine® Sensor operator interface consists of three pushbuttons and one 4-digit, 7-segment LCD display with 3 decimal points, plus (+), and minus (–) signs. It is responsible for the display of measured values and configuration of parameter values.

1.4 Specifications

Displayed pH	0-14 pH
Displayed Temperature Range	-10 °C to +110 °C (14 °F to 230 °F)
Process Temperature	-10 °C to +110 °C (14 °F to 230 °F)
Sensor Survivable Temperature Range Durafet II & III Meridian II	-10 °C to +130 °C (14 °F to 266 °F) 0 °C to 110 °C (32 °F to 230 °F)
Electronics Module Ambient Temperature	-20 °C to +85 °C (-4 °F to +185 °F)
Output Type	4-20 mA (2-wire loop powered)
Output Scale	0-14 pH
Output Calibration	4-20 mA
Mating Connector Rating	Submersible to 6.1m (20')
Output (Loop)	6m (19.7') cordset or Shielded twisted pair with field wiring connector
User Termination	Tinned leads
Cable Lengths Sensor:	<i>Durafet II & Durafet III:</i> 6.1m (20') or 15.24m (50') <i>Meridian II:</i> 3.65m (12') or 6.1m (20') <i>HPW7000:</i> .45m (1.5') or 10.97m (36')
Power	16-42 Vdc, 23mA max <i>Maximum load resistance:</i> 250 ohms at 16 Vdc 600 ohms at 24 Vdc 1400 ohms at 42 Vdc
Local Display and Buttons	LCD 4-digit, 7-segment
Engineering Units	pH degrees F degrees C
Calibration Options	1 point Sample or 2 point Sample Auto Buffer Recognition <i>Selections:</i> US, NIST, EURO
Solution Temperature Compensation	<i>Selections:</i> 0.00pH/10°C -0.16pH/10°C -0.32pH/10°C
Diagnostics	Sensor and electronics
Case	Weatherproof, corrosion-resistant plastic housing, NEMA4X
Approvals	CE Mark for Industrial Applications UL – General Purpose for Process Control CSA – General Purpose FM – CLI, DIV1, Groups A, B, C & D and CLI, Zone 0 AEx ia IIC (IS) FM – CLI, DIV2, Groups A, B, C & D and CLI, Zone 2, Groups IIC (N.I. Field Wiring)
Remote Mounting	Pipe, Wall, or DIN Rail
Dimensions	H 123 mm (4.84") x W 48 mm (1.89") x D 46 mm (1.81")
Weight	Approximately 142 g (5.0 oz.)

1.5 Model Selection Guide

Instructions

- Select the desired key number. The arrow to the right marks the selection available.
- Make the desired selections from Tables I through IV using the column below the proper arrow. A dot (•) denotes availability.

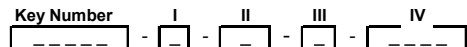

Key Number - DirectLine® Sensor Electronics Module

(Specify electrodes/cells/probes separately)

pH	For use with Durafet II, Meredian II & HPW7000 pH electrodes
ORP	For use with ORP electrode
Conductivity	For use with Contacting Conductivity Cells
DO - PPM	For use with Dissolved Oxygen ppm Probes
DO - PPB	For use with Dissolved Oxygen ppb Probes

Selection	Availability				
DL421	↓				
DL422		↓			
DL423			↓		
DL424				↓	
DL425					↓

TABLE I - OUTPUT CABLE

Output Cable for Integral or Remote Mounting	None (replacement module or customer supplied output cable)- Note 1 Cordset - 6m (19.7 ft.) - includes connector and cable - Note 2 Field Wiring Connector only - customer supplies cable only - Note 2
--	---

D	•	•	•	•	•
E	•	•	•	•	•
F	•	•	•	•	•

TABLE II - SENSOR CABLE/REMOTE CONNECTOR (between electronic module and electrode, sensor or probe)

Integral Mounting	No cable or connector required
Remote Mounting Cable - Durafet Only	6,096m (20 ft.) of sensor cable - Durafet II Remote Mtg w/PWB connector 6,096m (20 ft.) of sensor cable-Durafet III Remote Mtg w/Vario Pin connector- Note 3 15,24m (50 ft.) of sensor cable - Durafet II Remote Mtg w/PWB connector 15,24m (50 ft.) of sensor cable - Durafet III Remote Mtg w/Vario Pin connector- Note 3
Remote Mounting Connector (Cable is supplied with sensor or probe)	Remote Mounting Connector - Meredian II pH Remote Mounting Connector - Meredian II ORP Remote Mounting Connector - HPW7000 Remote Mounting Connector - Conductivity Remote Mounting Connector - Dissolved Oxygen

0	d	d	d	d	d
1	e				
7	e				
2	e				
8	e				
3	e				
3		e			
4	e				
5			e		
6				e	e

TABLE III - REMOTE MOUNTING OPTIONS

Mounting Kit for Remote Mounting	None Integral unit - mounting not required 2" (5.08 cm) Pipe mtg. bracket, wall mtg, & DIN Rail clip
----------------------------------	---

A	•	•	•	•	•
B	•	•	•	•	•

TABLE IV - OPTIONS

Tagging	None SS Customer ID Tag - 3 lines w/22 characters/line
Certificates	None Calibration & Conformance

00__	•	•	•	•	•
SS__	•	•	•	•	•
__00	•	•	•	•	•
__CC	•	•	•	•	•

Notes:

- Customers may procure their own output cordsets from the vendors listed below.
- Customers may make their own 4-20 mA output cordset using a 2-wire twisted shielded pair, and M12 field wiring connector procured from one of the vendors listed below. Use only UV rated outdoor cable to maintain NEMA 4 rating.

	Phoenix Contact	Turck
Cordset	SAC-3P-5.0-PUR/M12FSSH Stainless	RKV4T-6/S618
M12 Field Wiring Connector	SACC-M12FS-4CON-PG7	B8141-0
Cable	2-wire twisted shielded pair	

- Durafet III cables with Vario Pin connector require Durafet III electrode with Vario Pin connector

RESTRICTIONS

Restriction Letters	Available Only With		Not Available With	
	Table	Selection	Table	Selection
d	III	A		
e	III	B		

ORDERING INSTRUCTIONS:

- Part numbers are provided to facilitate Distributor Stock.
- Orders may be placed either by model selection or by part number.
- Part numbers are shown within the model selection tables to assist with compatibility information.
- Orders placed by model selection are systematically protected against incompatibility.
- Compatibility assessment is the responsibility of the purchaser for orders placed by part number.
- Items labeled as N/A are not available via the stocking program and must be ordered by model selection.

2. Installation

2.1 Assembly and Wiring

Depending on the customer selected output cable options, the DirectLine can be wired to an appropriate 16-42 Vdc source using 2 different methods:

- 1) cordset
- 2) field wiring with customer supplied cable.

Refer to Section 7 for wiring for CE Mark applications.

2.1.1 Cordset

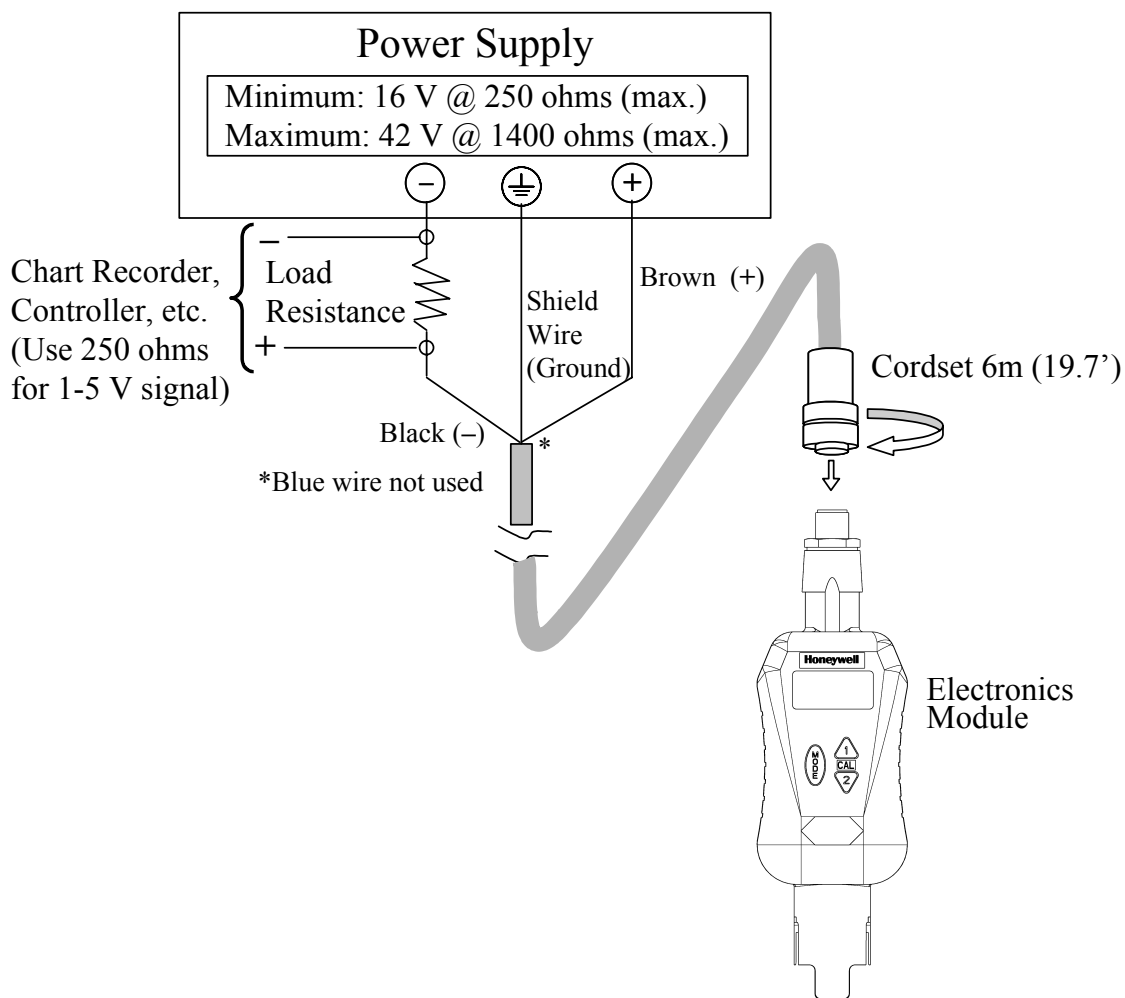

Figure 2-1 Cordset Connection and Wiring

2.1.2 Field Wiring

Refer to Figure 2-2. The field wiring connector supports customer supplied cable with an outer diameter of 4-6mm.

Table 2-1 Assembly and Wiring Procedure for Field Wiring Connector

Step	Procedure
1	Disassemble field wiring connector a) Unscrew parts to separate pressure screw, clamp type cage, gasket, housing and female insert.
2	Insert customer supplied cable through connector parts a) Slide pressure screw over skin and tinned customer cable (note orientation). b) Slide clamp type cage over cable (note orientation). c) Slide gasket over cable. d) Slide housing over cable (note orientation).
3	Connect wires to pins Look closely at end of female insert to locate pin numbers. Connect positive wire to pin 1 and negative wire to pin 4. Remaining wires and female insert pins 3 and 2 are unused.
4	Assemble field wiring connector a) Screw female insert to housing until female insert's o-ring is compressed. b) Slide clamp type cage/gasket into housing. c) Thread pressure screw into housing until ¼ turn past finger tight.
5	Connect cable to source Wire the other end of the Output cable to a 16-42 Vdc source as indicated in Figure 2-1. Note: your wire colors may be different.

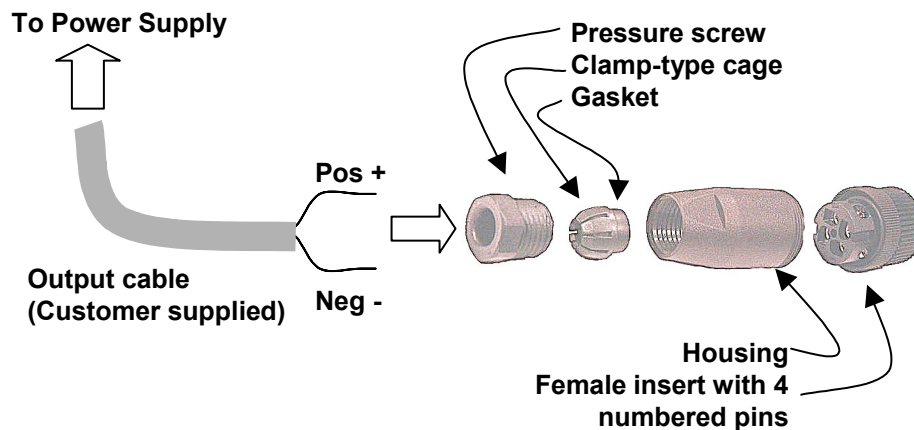

Figure 2-2 Field Wiring Connector

2.2 Integral Mounting

Table 2-2 Integral Mounting Procedure (refer to Figure 2-3)

Step	Procedure
Connect Electrode to Pipe and Electronics Assembly	
1	Screw the electrode into the pipe tee (3/4 " NPT thread). Make sure that the final position of the installed electronics module allows the display to be easily viewed by plant personnel.
2	Align the slots in the electronics module with those in the electrode and press down to connect the electronics to the electrode.
3	Tighten the locking screw on the bottom rear of the electronics module.

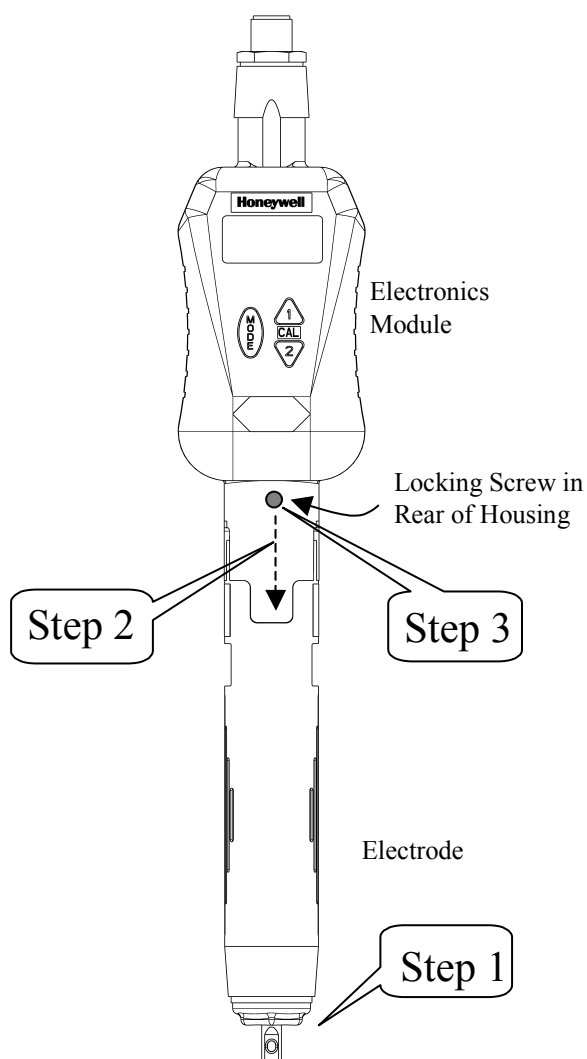



Figure 2-3 Integral Mounting

2.3 Remote Mounting

Table 2-3 Remote Mounting Procedure for Durafet II and Durafet III Electrodes

Step	Procedure (Refer to Figure 2-4 and Figure 2-5)
1	Apply a thin film of silicon grease to the ID of electronics module's remote mounting cavity.
2	<p>Connect Remote Sensor Wiring Cable to the Remote Electronics Housing</p> <p>a) Remove the cover from the remote cable connector.</p> <p>b) Align the slots in the cable connector housing with those in the electronics module and push up to connect the cable to the electronics module.</p> <p>c) Tighten the locking screw on the rear of the electronics module. Make sure the connector is completely seated.</p>
3	<p>Secure Electronics Module with Wall, Pipe, or DIN Rail Mounting</p> <p>Mount bracket with clips facing forward, smaller clip on top and larger clip on bottom.</p> <p><i>Wall:</i> Use one of three through-holes to secure to wall.</p> <p><i>Pipe:</i> Feed hose clamp through two slots and secure to pipe.</p> <p><i>DIN rail:</i> Attach the appropriate DIN rail clip to the mounting bracket: "U" DIN rail—use metal clip and shorter screw (8 mm) "G" DIN rail—use gray clip and longer screw (10 mm)</p> <p>Clip can be rotated for horizontal or vertical DIN rails.</p> <p>Push electronics module onto the remote mounting bracket until it snaps into position.</p>
4	<p>Connect Remote Sensor Wiring Cable to the Remotely Mounted Electrode</p> <p>Durafet II with PC Board type connector:</p> <p>a) Remove cover from the remote cable connector.</p> <p>b) Loosen the ferrule and slide back the ferrule, small O-ring, and plastic cover to expose the remote cable connector. Align the cable connector keyway with the electrode key (small black tab on the top of the electrode). Slide the plastic cover over the electrode end and hand-tighten the cover onto the electrode. Be careful not to cross the threads of the connector. Slide the O-ring and ferrule down the cable to the back of the cover cap. Hand-tighten the ferrule onto the cover cap.</p> <p>-OR-</p> <p>Durafet III with Vario Pin, 11 conductor connector:</p> <p> Electrostatic Discharge (ESD) hazards. Observe precautions for handling electrostatic sensitive devices.</p> <p>a) Remove cover from the cable connector.</p> <p>b) Make sure electrode connector and cable connector are clean and dry.</p> <p>c) Align keyway of Vario Pin connector on electrode with tab inside mating connector on cable. Press cable connector onto electrode firmly.</p> <p>d) Tighten knurled busing of cable connector by hand to ensure waterproof seal.</p>

When the DL421 is specified with Table II = 3, the Remote Connector Assembly (part number 51500768-001) is supplied loose for connection of the Meredian II pH electrode cable to the DL421 module. Table 2-4 gives the mounting procedure.

Table 2-4 Remote Mounting Procedure for Meredian II Electrodes

Step	Procedure (Refer to Figure 2-4 and Figure 2-5)
1	Turning counterclockwise, remove strain relief/cover combination from the remote connector assembly.
2	Remove the protective plastic bag from the end of the electrode cable. Be careful to keep bare fingers away from coax cable termination.
3	Loosen and remove compression cap from strain relief fitting. Carefully push cable end through cap and strain relief fitting so that these parts are strung back along cable jacket.
4	Connect cable leads as follows: Terminal 1 = Orange Reference Electrode Lead Terminal 2 = White Temperature Compensation Lead Terminal 3 = White Temperature Compensation Lead Terminal 4 = Pigtail Shield Lead Terminal 5 = NC (No Connection) Terminal 6 = Coax Measuring Electrode Lead Earth Ground = Yellow
5	Slide cover along cable and tighten by hand onto the remote connector assembly.
6	Slide cap along cable and tighten onto cable jacket with small wrench until cable cannot slide within strain relief rubber bushing.
7	Remove yellow protective sleeve from opposite end of connector assembly.
8	Apply a thin film of silicon grease to the ID of electronics module's remote mounting cavity.
9	Plug remote connector assembly into DL421 module aligning polarity tab of module housing and mating groove on connector.
10	<p>Secure Electronics Module with Wall, Pipe, or DIN Rail Mounting</p> <p>Mount bracket with clips facing forward, smaller clip on top and larger clip on bottom.</p> <p><i>Wall:</i> Use one of three through-holes to secure to wall.</p> <p><i>Pipe:</i> Feed hose clamp through two slots and secure to pipe.</p> <p><i>DIN rail:</i> Attach the appropriate DIN rail clip to the mounting bracket: "U" DIN rail—use metal clip and shorter screw (8 mm) "G" DIN rail—use gray clip and longer screw (10 mm)</p> <p>Clip can be rotated for horizontal or vertical DIN rails.</p> <p>Push electronics module onto the remote mounting bracket until it snaps into position.</p>

When the DL421 is specified with Table II = 4, the Remote Connector Assembly (part number 51500768-002) is supplied loose for connection of the HPW7000 electrode cables to the DL421 module. Table 2-5 gives the mounting procedure.

Table 2-5 Remote Mounting Procedure for HPW7000 Electrodes

Step	Procedure (Refer to Figure 2-4 and Figure 2-5)
1	Turning counterclockwise, remove strain relief/cover combination from the remote connector assembly.
2	Remove the protective plastic bag from the end of the measuring electrode cable. Be careful to keep bare fingers away from coax cable termination.
3	Loosen and remove compression cap from strain relief fitting. Carefully push all 3 cable ends through cap and strain relief fitting so that these parts are strung back along cable jacket.
4	Connect cable leads as follows: Terminal 1 = Clear Reference Electrode Coax Lead Terminal 2 = Black Temperature Compensation Lead Terminal 3 = White Temperature Compensation Lead Terminal 4 = Black/White Measuring Electrode Coax Shield Terminal 5 = Clear Measuring Electrode Coax Lead Terminal 6 = No Connection Earth Ground = (3) Green/White Leads from Measuring, Reference and Temperature
5	Slide cover along cables and tighten by hand onto the remote connector assembly.
6	Slide cap along cables and tighten onto cable jackets with small wrench until cables cannot slide within strain relief rubber bushing.
7	Remove yellow protective sleeve from opposite end of connector assembly.
8	Apply a thin film of silicon grease to the ID of electronics module's remote mounting cavity.
9	Plug remote connector assembly into DL421 module aligning polarity tab of module housing and mating groove on connector.
10	<p>Secure Electronics Module with Wall, Pipe, or DIN Rail Mounting</p> <p>Mount bracket with clips facing forward, smaller clip on top and larger clip on bottom.</p> <p><i>Wall:</i> Use one of three through-holes to secure to wall.</p> <p><i>Pipe:</i> Feed hose clamp through two slots and secure to pipe.</p> <p><i>DIN rail:</i> Attach the appropriate DIN rail clip to the mounting bracket: "U" DIN rail—use metal clip and shorter screw (8 mm) "G" DIN rail—use gray clip and longer screw (10 mm)</p> <p>Clip can be rotated for horizontal or vertical DIN rails.</p> <p>Push electronics module onto the remote mounting bracket until it snaps into position.</p>

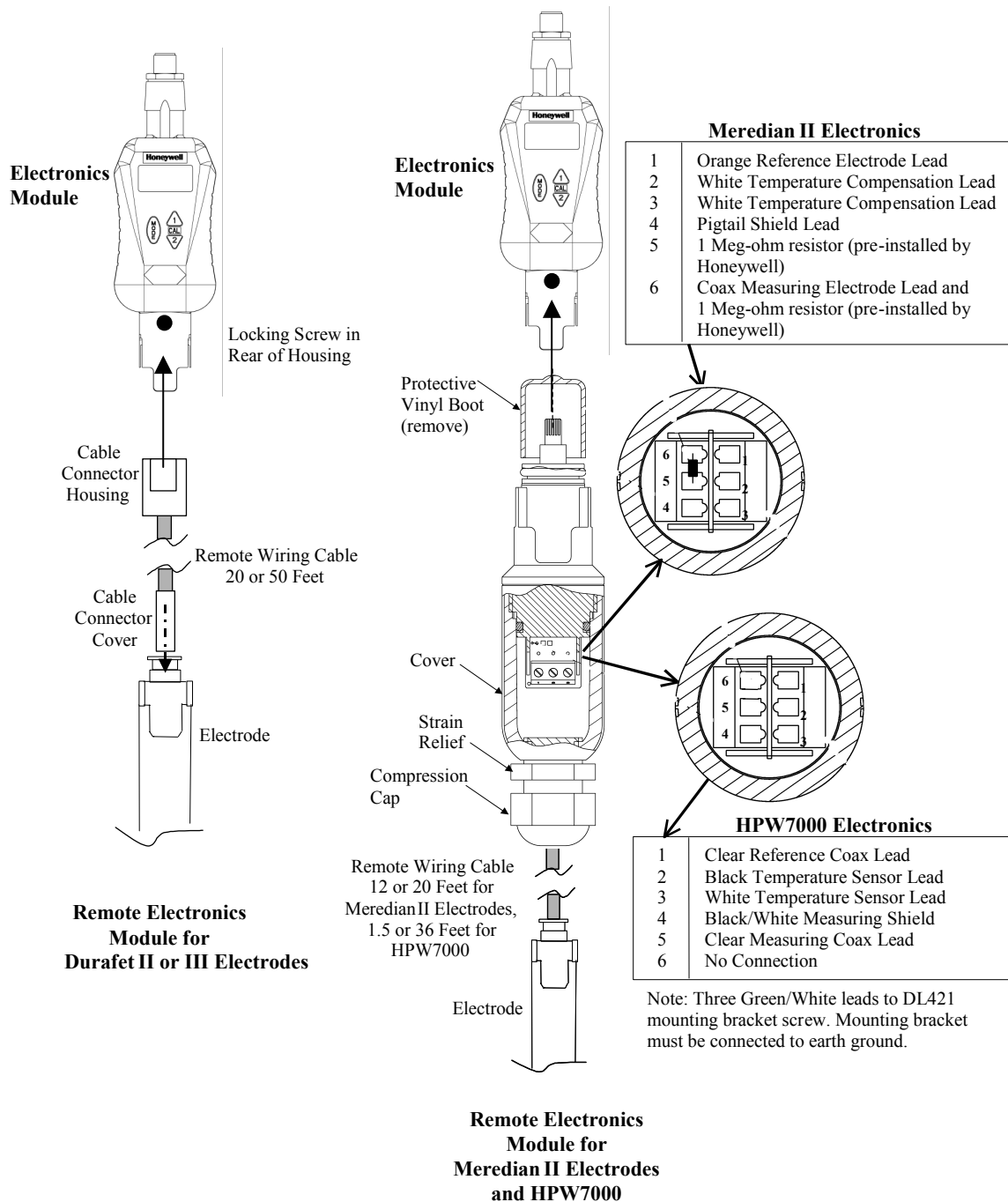
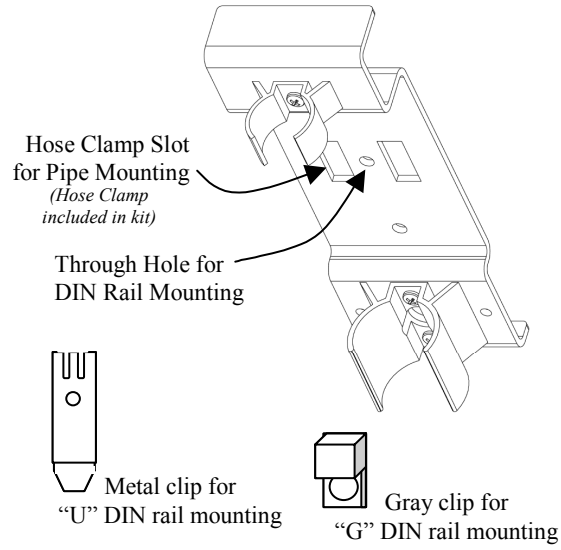

Figure 2-4 Remote Mounting



Mounting Kit

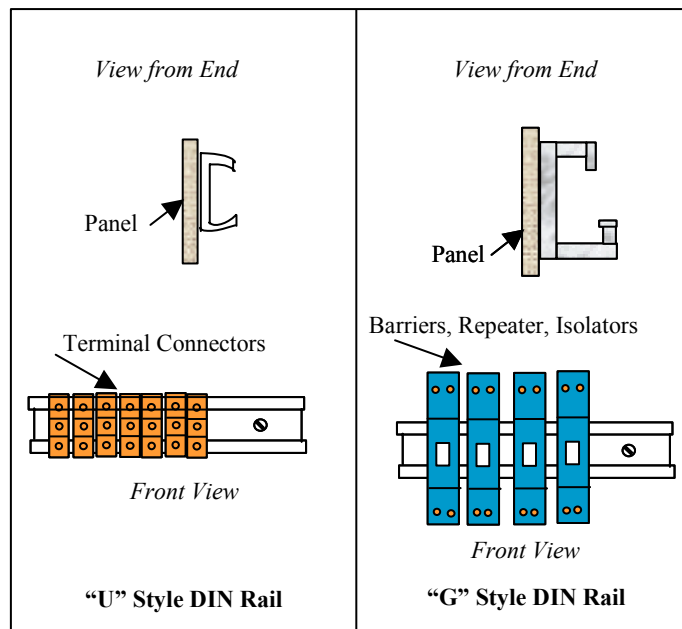

Figure 2-5 Remote Mounting Hardware

2.4 Conduit connections

The DirectLine provides a male ½” NPT thread to accommodate a customer conduit connection. Use ½” conduit coupling (min. 38.1mm (1.5”) long) on DL conduit connection to clear cordset connector. Conduit can not be used with field wiring connector due to size restriction.

Do not exceed 200in-lb. torque when attaching fixed piping.

Use wrench flats provided under the ½” NPT threads to support the DirectLine during installation.

3. Configuration

3.1 Overview

Configuration Parameters

Set Up consists of configuring the following functions:

- Buffer Group Selection** – Only used with Auto Buffer Recognition calibrations. Determines the set of standard pH buffer values to be used for Zero (standardization) and Slope calibration by automatic buffer recognition. Each of the available Buffer Groups is a set of 5 pH buffer standards that you can select.
 The available groups are: US (*default*), NIST, and EURO.

Table 3-1 Buffer Groups and the pH standard values

Buffer Group	pH Buffers					Display
US (default)	2	4	7	10	12	US
NIST	1.68	4.01	6.86	9.18	12.45	nISt
EURO	1	3	6	8	10	Euro

- Solution Temperature Coefficient** – Typically only used in power plants for condensate/feedwater applications. Measured pH is displayed and transmitted to a pH value normalized to what the pH value would be if the temperature of the process was 25 °C. Magnitude of normalization is dependent upon the Solution Temperature coefficient, expressed in units of pH/10 °C with precision to the hundredth decimal place.
 The three available values are: 0.00 (*standard setting, default*), -0.16 pH/10 °C (*pure water*), and -0.32 pH/10 °C (*condensate/feedwater*).
- Noise Suppression Frequency Selection** – Selection of 50 Hz or 60 Hz. Defaults to 60 Hz at unit reset.
- Output Configuration** – The following Output Configuration functions can be selected:
 - 0% Range** 0 % Range values can be adjusted within a range 0.00 to 14.00 pH in 0.50 pH increments.
 - 100% Range** 100 % Range values can be adjusted within a range 0.00 to 14.00 pH in 0.50 pH increments.
 - 0% Calibration** Output current can be typically adjusted to within a range of 3.80 mA to 4.40 mA.
 - 100% Calibration** Output current can be typically adjusted to within a range of 19.60 mA to 20.40 mA.

3.2 Configuration Set Up Procedure

ATTENTION:

In Table 3-2, under the **Press** column:



- **Hold** means to hold the button down until the display changes.
- **Momentarily** means to press and release the indicated button.

From the Online pH display, follow this procedure.







ATTENTION:



If no key is pressed for 60 seconds, the display will abort the entry mode and default to Online Display.

Table 3-2 Configuration Set Up Procedure

Step	Operation	Press	Display
1	Enter Buffer Group Selection	MODE Hold	bFrG (for 1 second) then, (Current Buffer Group Selection)
	Edit Buffer Group	MODE Hold	Flashing Display – You are now in EDIT mode (Value of current Buffer Group selection)
	Select desired Buffer Group	 Momentarily	To select US (default), NIST , or Euro
	Save the Buffer Group	MODE Momentarily	Selection for group
2	Enter Solution Temperature Coefficient Selection	MODE Momentarily	COEF (for 1 second) then, (Solution Temperature Coefficient Selection)
	Edit Solution Temperature Coefficient	MODE Hold	Flashing Display – You are now in EDIT mode (Value of current Coefficient selection)
	Select desired Coefficient	 Momentarily	To select: 0.00 pH/10°C (default) or -0.16 pH/10°C (pure water) -0.32 pH/10°C (AVT, Amine, Phosphate or Oxygenated Treatment)
	Save the Solution Temperature coefficient	MODE Momentarily	Selection for coefficient

Configuration

Step	Operation	Press	Display
3	Enter Noise Suppression Frequency	MODE Momentarily	nSUP (for 1 second) then, (Noise Suppression Frequency Selection)
	Edit Noise Suppression Frequency	MODE Hold	Flashing Display – You are now in EDIT mode (Value of current Frequency selection)
	Select desired Frequency	 Momentarily	To select 50 Hz or 60 Hz (default)
	Save the Noise Suppression Frequency	MODE Momentarily	Selection for frequency
4	Enter Output Configuration	MODE Momentarily	OutC Enter Output Calibration
	0% Range Value Selection	 Momentarily	rnGL (for 1 second) then, (value of current 0 % Range Value Selection)
	Edit 0 % Range Value Selection	MODE Hold	Flashing Display – You are now in EDIT mode Value of current 0 % selection)
	Select desired 0 % pH Value	 Momentarily	Selected 0 % pH Value in 0.50 pH increments Range: 0.00 to 14.00 pH (default 0.00)
	Save the New 0 % Range Value	MODE Momentarily	(New Value)
5	100 % Range Value Selection	 Momentarily	rnGH (for 1 second) then, (value of current 100% Range Value Selection)
	Edit 100 % Range Value Selection	MODE Hold	Flashing Display – You are now in EDIT mode (value of current 100 % selection)
	Select 100 % pH Value	 Momentarily	Selected 100 % pH Value in 0.50 pH increments Range: 0.00 to 14.00 pH (default 14.00)
	Save the New 100 % Range Value	MODE Momentarily	(New Value)
6	0 % Calibration	 Momentarily	AdJL
	Adjust 0 % Calibration	MODE Hold	AdJL (flashes) – You are now in EDIT mode Range: 3.80 to 4.40 mA typically (default 4.00 mA)
		 Momentarily	+AdJL (increments value) -AdJL (decrements value)
	Save 0 % Calibration	MODE Momentarily	AdJL

Step	Operation	Press	Display
7	100 % Calibration	 Momentarily	AdJH
	Adjust 100 % Calibration	MODE Hold	AdJH (flashes) – You are now in EDIT mode Range: 19.60 to 20.40 mA typically (default 20.00 mA)
		  Momentarily	+AdJH (increments value) –AdJH (decrements value)
	Save 100 % Calibration	MODE Momentarily	AdJH
8	Return to Online Display	MODE Momentarily	Returns to Online Display

4. Calibration

4.1 Calibration Diagnostics

Introduction

The manual and automatic standardization and slope adjustments change the zero offset and the percent theoretical slope calibration diagnostics used by this system. These values are viewed as read-only information. It is good practice to observe these values after calibration. Monitoring the values over time will help you predict when the electrode will need to be replaced.

Zero Offset pH Value

When Online pH value is displayed, **PRESS** ▲ button momentarily to display the current **Zero Offset value** in fixed hundredths decimal position.

Zero Offset is non-volatile and is initialized to 0.00 pH at unit reset.

It has a range of -2.00 pH to +2.00 pH and it is updated after each calibration.

Percent Theoretical Slope Value

When Online pH value is displayed, **PRESS** ▼ button momentarily to display the current **Percent Theoretical Slope value** in fixed tenths decimal position.

Percent Theoretical Slope is non-volatile and is initialized to 100.0 % at unit reset.

It has a range of 80.0 % to 105.0 % and it is updated after each calibration.

60 Second Timeout

If no key is pressed for 60 seconds, the display will abort the entry mode and default to Online Display.

4.2 Calibration Diagnostic Reset

Introduction

When a new electrode is installed, the indicated pH will use the zero offset and percent theoretical slope values from the previous calibration. Depending on the condition of the replaced electrode, the difference between the known and indicated pH of the new electrode may vary as much as several pH units. A calibration on the new electrode will correct this difference.

ATTENTION:

If Auto Buffer Recognition (ABR) calibration is used when the new electrode is calibrated for the first time, the ABR calibration may select a buffer value from the selected standard buffer group table (Table 4-1) that is directly above or below the actual buffer value.

To avoid this discrepancy, follow one of the two procedures listed below:

1. Select the correct buffer value by following Step 2B of Table 4-3.
 2. Perform a calibration diagnostic reset as described below prior to performing an ABR calibration on the new electrode.
-

Zero Offset pH Value and Percent Theoretical Slope Value

- a) Momentarily press ▲ to view the Zero Offset value. From this display press and hold the ▲ button until the Zero Offset pH value resets to factory default “0.00”. The Percent Theoretical Slope value resets to factory default “100.0” at the same time (approximately 10 seconds).
- b) Press MODE button, or wait 60 seconds, to return to Online pH.

4.3 Calibration

Overview

ATTENTION:

If a Solution Temperature Compensation Coefficient was selected per Configuration Section 3.2, this coefficient is disabled while calibration is being performed.

Calibration consists of the following functions:

- **Calibrating the Zero (Standardization)** – Manual or automatic pH calibration. In auto calibration, you can select one of the other buffer pH values directly above or below the recognized buffer value in the current buffer group. (See Table 4-1.)
- **Calibrating the Slope** - Manual or automatic pH calibration. In auto calibration, you can select one of the other buffer pH values directly above or below the recognized buffer value in the current buffer group. (See Table 4-1.)

Table 4-1 Standard pH Buffer Values

Temp °C		0	5	10	15	20	25	30	35	40	45	50
<i>Group</i>	<i>Buffer</i>											
US <small>(default)</small>	2	2.01	2.01	2.01	2.01	2.00	2.00	2.00	2.00	2.00	2.00	2.00
	4	4.01	3.99	4.01	3.99	4.00	4.00	4.01	4.02	4.03	4.04	4.05
	7	7.13	7.10	7.07	7.05	7.02	7.00	6.99	6.98	6.97	6.97	6.97
	10	10.34	10.26	10.19	10.12	10.06	10.00	9.94	9.90	9.85	9.82	9.78
	12	12.60	12.44	12.28	12.14	12.00	11.88	11.79	11.66	11.53	11.43	11.32
NIST	1.68	1.67	1.67	1.67	1.67	1.68	1.68	1.68	1.69	1.69	1.70	1.71
	4.01	4.01	4.00	4.00	4.00	4.00	4.01	4.01	4.02	4.03	4.04	4.06
	6.86	6.98	6.95	6.92	6.90	6.88	6.86	6.85	6.84	6.84	6.83	6.83
	9.18	9.48	9.40	9.33	9.28	9.23	9.18	9.14	9.10	9.07	9.04	9.01
	12.45	13.42	13.21	13.01	12.80	12.64	12.45	12.30	12.13	11.99	11.84	11.71
EURO	1	0.98	0.98	0.99	0.99	1.00	1.00	1.01	1.01	1.01	1.01	1.02
	3	3.02	3.02	3.02	3.02	3.00	3.00	2.99	2.99	2.98	2.98	2.97
	6	6.03	6.02	6.01	6.00	6.00	6.00	6.00	6.01	6.02	6.04	6.05
	8	8.15	8.11	8.07	8.03	8.00	7.97	7.94	7.91	7.88	7.87	7.86
	10	10.22	10.17	10.12	10.05	10.00	9.95	9.90	9.86	9.82	9.78	9.74

Calibration Procedures

ATTENTION:

CAL2 must be done within 10 minutes of **CAL1**, otherwise **CAL1** must be repeated to enable **CAL2**.

ATTENTION:

In Table 4-2 and Table 4-3, under the **Press** column:

- **Hold** means to hold the button down until the display changes.
- **Momentarily** means to press and release the indicated button.

Table 4-2 Zero (Standardization) Calibration Procedure















Step	Operation	Press	Display
1	Enter Zero (Standardization) Calibration	 Hold	CAL1 For Sample (Manual) calibration, go to step 2A . OR For Auto Buffer Recognition calibration, go to step 2B .
2A	Do Sample (Manual) Calibration	 Momentarily	SCAL for one second, then displays Live Buffer Value.
	Edit Buffer Value	 or  Momentarily	To edit Buffer Value (<i>Flashing Display</i>)
	Save New Buffer Value	MODE Momentarily	Buffer Value is saved and goes to Online Display .
OR			
2B	Do Auto Buffer Recognition Calibration	 Hold	ACAL for one second, then displays closest Group Buffer Value. (<i>Flashing Display until stable reading is achieved</i>)
	Edit Group Buffer Value	 or  Momentarily	“New Value” – Selects ± 1 buffer group (<i>Flashing Display until stable reading is achieved</i>) then goes to Online Display .

Table 4-3 Slope Calibration Procedure

Step	Operation	Press	Display
1	Enter Slope Calibration	 Hold	CAL2 For Sample (Manual) calibration, go to step 2A . OR For Auto Buffer Recognition calibration, go to step 2B .
2A	Do Sample (Manual) Calibration	 Momentarily	SCAL for one second then, displays Live Buffer Value
	Edit Buffer Value	 or  Momentarily	To edit Buffer Value (<i>Flashing Display</i>)
	Save New Buffer Value	MODE Momentarily	Buffer Value is saved and goes to Online Display .
OR			
2B	Do Auto Buffer Recognition Calibration	Hold 	ACAL for one second then, displays closest Group Buffer Value (<i>Flashing Display until stable reading is achieved</i>)
	Edit Group Buffer Value	 or  Momentarily	“New Value” – Selects ± 1 buffer group (<i>Flashing Display until stable reading is achieved</i>) then goes to Online Display

4.4 Calibration in High Purity Water

When the DirectLine module is used with the HPW7000 High pHurity Water Assembly an addition calibration step may be required. This involves doing an independent check of the pH with a portable lab meter and then, if necessary, a Sample Cal to correct the reading.

Table 4-4 High purity water calibration Procedure

Step	Procedure
1	Perform a 2-point calibration using either the Auto Buffer Recognition Calibration or Manual Calibration per section 4.3.
2	Return the HPW7000 electrodes to the flow chamber and restart flow to the chamber.
3	Allow the flow chamber to “clean out” by flowing sample through the chamber for at least an hour.
4	Check the pH of the process using a portable instrument that uses a flowing reference type electrode. Make sure the sample is not exposed to air, otherwise the pH due to absorption of carbon dioxide from the air.
5	If necessary adjust the HPW7000 pH to agree with the portable instrument reading by doing a 1-point Sample Cal per section 4.3.

5. Operation

5.1 Displays

Overview

The DirectLine® DL421 displays the pH value, Temperature, Zero Offset pH value, and Percent Theoretical Slope online. The table below describes these parameters.

Table 5-1 Online Parameter Descriptions

Parameter	Description
Online pH	Measured pH expressed with fixed hundredths decimal precision. Range: 0.00 to 14.00
Online Temperature	Measured temperature expressed with fixed tenths decimal precision. Temperature displayed in °C or °F Range: –10.0 to 110.0 °C –14.0 to 230.0 °F
Zero Offset pH Value	Zero Offset pH value expressed with fixed hundredths decimal precision. Range: –2.00 to +2.00 pH
Percent Theoretical Slope Value	Percent Theoretical Slope value expressed with fixed tenths decimal precision. Range: 80.0 % to 105.0 %

The default display and home position is the **Online pH** display. It appears when:

- *The unit is powered up*
- *No button presses for 60 seconds*
- *A successful Zero (Standardization) or Slope calibration has occurred in **Auto Buffer Recognition***
- *The Mode button has been pressed during Zero (Standardization) or Slope calibration (**Sample Calibration**)*
- *The Mode button has been pressed during a configuration edit*

The measurement and display of pH is updated at a rate of 500 ms.

ATTENTION:

In Table 5-2, under the **Press** column:

- **Momentarily** means to press and release the indicated button.

Table 5-2 Display Navigation Procedure

Step	Operation	Press	Display
1	View Online pH value	MODE Momentarily	<i>(measured pH)</i>
2	View Online Temperature	MODE Momentarily	<i>(measured temperature in °C or °F)</i> Proceed to step 2A or step 3 .
2A	Toggle Online Temperature display units	▲ or ▼ Momentarily	<i>(measured temperature in °C or °F)</i> Proceed to step 3 .
3	Return to home position	MODE Momentarily	<i>(measured pH)</i>

5.2 Diagnostic Error Messages

When a diagnostic error or status condition occurs, the Online Display alternates between measured pH and a text message.

Table 5-3 Online Diagnostic Errors

What you see	What it is	What to do
CNFG	Data error detected.	Reset unit or cycle power. Second occurrence will show FALT.
FALT	Unit electronics are defective.	Replace electronics module.
<i>These errors may occur when online pH or temperature is displayed.</i>		
P HI	Measured pH is > 14.00 pH	Bring process within limits
P LO	Measured pH is < 0.00 pH	Bring process within limits
PRBE	Probe is defective, removed from process, or not connected. Forces the output to burnout level (greater than 21.8 mA).	Check probe, connection and presence of sample. When the source of the error is removed, the error will clear and the output will return to normal operation.
T HI	Measured temperature is > 110 °C	Bring process within limits
T LO	Measured temperature is < -10 °C	Bring process within limits
<i>These errors may occur during probe calibration and abort the calibration process.</i>		
FAIL	These error messages are preceded by the message "FAIL" BFRS The Slope buffer is less than 2 pH from Zero (Standardization) buffer. SRNG The Slope calibration failed due to a calculated Percent Theoretical Slope value outside the range of 80.0 % to 105.0 %. STBL The Zero (Standardization) or Slope calibration failed due to measured pH instability. TRNG The Zero (Standardization) or Slope calibration failed due to solution temperature outside the range of 0 °C to 50 °C. (Auto Buffer Recognition calibration only) ZRNG The Zero (Standardization) calibration failed due to a calculated Zero Offset value outside the range of -2.00 pH to 2.00 pH.	Press Mode to return to online display.

5.3 Unit Reset

Overview

Unit Reset initializes all of the DirectLine® Sensor’s calibration and configuration data to factory default values.

Procedure

- From the Online pH display, press and hold the ▲ and ▼ buttons simultaneously until “rSEt” appears on the display (**minimum of 10 seconds**).
- “rSEt” will remain on the display until reset is complete. Next, the firmware version number appears briefly and the unit then returns to the Online pH display.

Table 5-4 Factory Default Values

Data	Default Values
Zero Offset	0.00 pH
Slope	100.0 %
Online Temperature	°C
Buffer Group Selection	US
Solution Temperature Coefficient Selection	0.00 pH/10 °C
Noise Suppression Frequency Selection	60 Hz
Output Configuration – 0 % Range Value	0.00 pH
Output Configuration – 100 % Range Value	14.00 pH
Output Configuration – 0 % Calibration	4.00 mA typically
Output Configuration – 100 % Calibration	20.00 mA typically

6. Spare Parts

Part Number	Description
51452682-001	DirectLine® DL421 Sensor Module (Replacement Module)
51452683-001	6 m cordset
51452684-002	Field Wiring connector (supports customer supplied cable (4-6mm OD))
51500270-001	Remote Electrode Mounting Cable – 20 foot (Durafet II only)
51500270-002	Remote Electrode Mounting Cable – 50 foot (Durafet II only)
51453225-001	Remote Electrode Mounting Cable – 20 foot (Durafet III only)
51453225-002	Remote Electrode Mounting Cable – 50 foot (Durafet III only)
31086221	O-ring for Integral Durafet Electrode or Remote Electrode Mounting Cable or External O-ring for Integral Meredian Electrode or Remote Electrode Cable Connector
51452655-001	Remote Mounting Kit for Wall, Pipe, or DIN Mounting
51500768-001	Remote Electrode Cable Connector Assembly (Meredian II Electrodes) — Includes O-rings and strain relief
51500768-002	Remote Electrode Cable Connector Assembly (HPW7000 Electrodes) — Includes O-rings and strain relief
51452706-001	Locking screw (locks sensor module to electrode or remote connector)

Cordset

The cordset connection is an M12 female type that can be purchased directly from Honeywell or from multiple vendors including:

Turck Industries

Part Number RKV4T-6/S618 for a 6 m cordset with a stainless coupling nut

Part Number RK4T-6/S618 for a 6 m cordset with a nickel plated coupling nut

Phoenix Contact

Part Number SAC-3P-5.0-PUR/M12FSSH Stainless for a 5m cordset with a stainless coupling nut

Part Number SAC-3P-5.0-PUR/M12FSSH for a 5m cordset with a nickel plated coupling nut

Field Wiring connector

The Field Wiring Connector is an all-plastic screw terminal M12 female type that can be purchased directly from Honeywell or from multiple vendors including:

Turck Industries

Part Number B8141-0 for a M12 field wiring connector that accommodates customer supplied cable.

Phoenix Contact

Part Number SACC-M12FS-4CON-PG7 for a M12 field wiring connector that accommodates customer supplied cable.

7. Appendix: CE Mark Applications

In situations where the pH display appears to fluctuate (short deviations above 0.2 pH points) due to field wiring electrical noise, the noise may be reduced by making the additional ground connections as described in Figure 7-1.

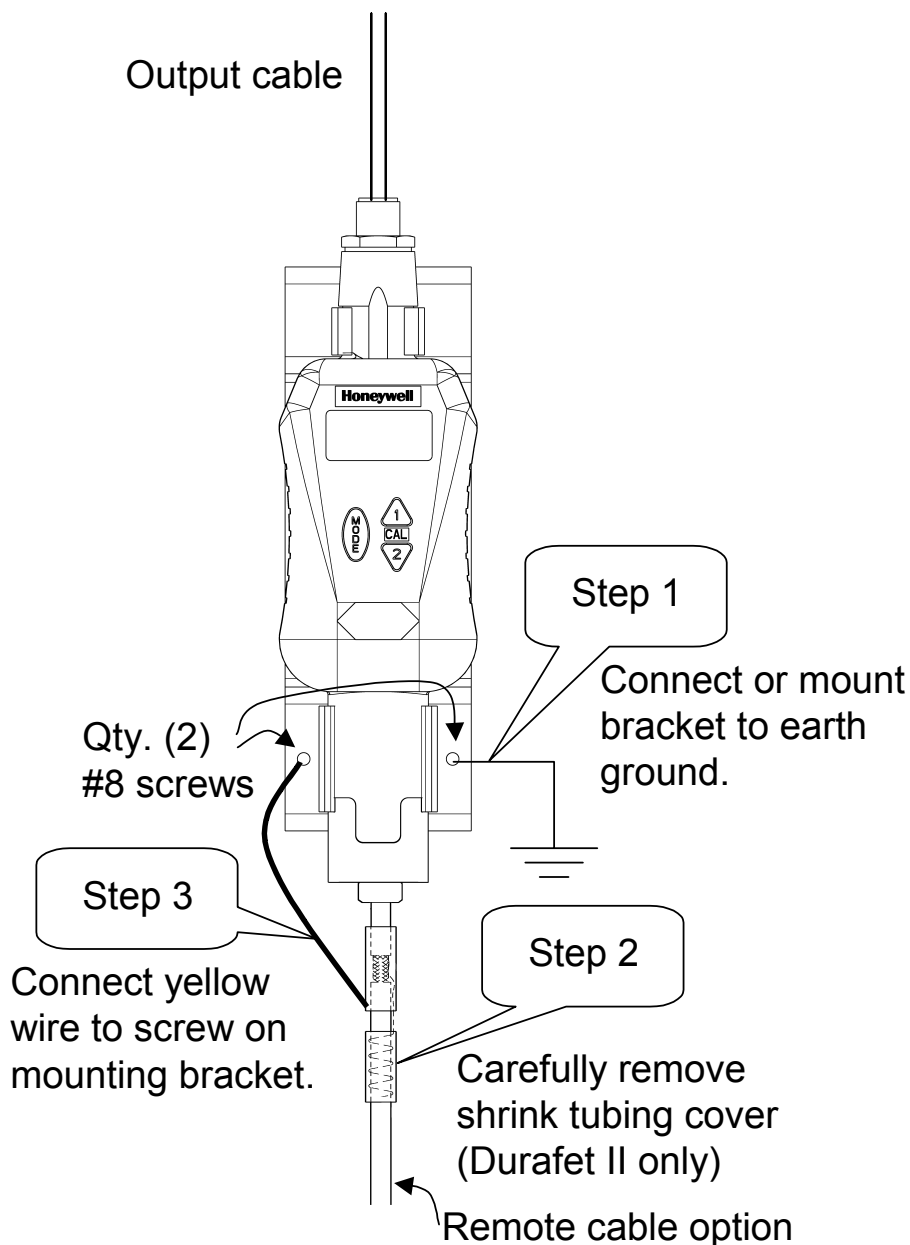

Figure 7-1 Wiring for CE Mark Applications

8. Sales and Service

For application assistance, current specifications, pricing, or name of the nearest Authorized Distributor, contact one of the offices below.

<p>ARGENTINA HONEYWELL S.A.I.C. BELGRANO 1156 BUENOS AIRES ARGENTINA Tel. : 54 1 383 9290</p> <p>ASIA PACIFIC HONEYWELL ASIA PACIFIC Inc. Room 3213-3225 Sun Kung Kai Centre N° 30 Harbour Road WANCHAI HONG KONG Tel. : 852 829 82 98</p> <p>AUSTRALIA HONEYWELL LIMITED 5 Thomas Holt Drive North Ryde Sydney NSW AUSTRALIA 2113 Tel. : 61 2 353 7000 AUSTRIA</p> <p>HONEYWELL AUSTRIA G.m.b.H. Handelskai 388 A1020 VIENNA AUSTRIA Tel. : 43 1 727 800</p> <p>BELGIUM HONEYWELL S.A. 3 Avenue de Bourget B-1140 BRUSSELS BELGIUM Tel. : 32 2 728 27 11</p> <p>BRAZIL HONEYWELL DO BRAZIL AND CIA Rua Jose Alves Da Chunha Lima 172 BUTANTA 05360.050 SAO PAULO SP BRAZIL Tel. : 55 11 819 3755</p> <p>BULGARIA HONEYWELL EOOD 14, Iskarsko Chausse POB 79 BG- 1592 Sofia BULGARIA Tel : 359-791512/ 794027/ 792198</p>	<p>CANADA HONEYWELL LIMITED THE HONEYWELL CENTRE 300 Yorkland Blvd. NORTH YORK, ONTARIO M2J 1S1 CANADA Tel.: 800 461 0013 Fax:: 416 502 5001</p> <p>CZECH REPUBLIC HONEYWELL, Spol.s.r.o. Budejovicka 1 140 21 Prague 4 Czech Republic Tel. : 42 2 6112 3434</p> <p>DENMARK HONEYWELL A/S Automatikvej 1 DK 2860 Soeborg DENMARK Tel. : 45 39 55 56 58</p> <p>FINLAND HONEYWELL OY Ruukintie 8 FIN-02320 ESPOO 32 FINLAND Tel. : 358 0 3480101</p> <p>FRANCE HONEYWELL S.A. Bâtiment « le Mercury » Parc Technologique de St Aubin Route de l'Orme (CD 128) 91190 SAINT-AUBIN FRANCE Tel. from France: 01 60 19 80 00 From other countries: 33 1 60 19 80 00</p> <p>GERMANY HONEYWELL AG Kaiserleistrasse 39 D-63067 OFFENBACH GERMANY Tel. : 49 69 80 64444</p> <p>HUNGARY HONEYWELL Kft Gogol u 13 H-1133 BUDAPEST HUNGARY Tel. : 36 1 451 43 00</p> <p>ICELAND HONEYWELL Hataekni .hf Armuli 26 PO Box 8336 128 reykjavik Iceland Tel : 354 588 5000</p>	<p>ITALY HONEYWELL S.p.A. Via P. Gobetti, 2/b 20063 Cernusco Sul Naviglio ITALY Tel. : 39 02 92146 1</p> <p>MEXICO HONEYWELL S.A. DE CV AV. CONSTITUYENTES 900 COL. LOMAS ALTAS 11950 MEXICO CITY MEXICO Tel : 52 5 259 1966</p> <p>THE NETHERLANDS HONEYWELL BV Laaderhoogteweg 18 1101 EA AMSTERDAM ZO THE NETHERLANDS Tel : 31 20 56 56 911</p> <p>NORWAY HONEYWELL A/S Askerveien 61 PO Box 263 N-1371 ASKER NORWAY Tel. : 47 66 76 20 00</p> <p>POLAND HONEYWELL Sp.z.o.o Ul Domainewska 41 02-672 WARSAW POLAND Tel. : 48 22 606 09 00</p> <p>PORTUGAL HONEYWELL PORTUGAL LDA Edificio Suecia II Av. do Forte nr 3 - Piso 3 2795 CARNAXIDE PORTUGAL Tel. : 351 1 424 50 00</p> <p>REPUBLIC OF IRELAND HONEYWELL Unit 1 Robinhood Business Park Robinhood Road DUBLIN 22 Republic of Ireland Tel. : 353 1 4565944</p> <p>REPUBLIC OF SINGAPORE HONEYWELL PTE LTD BLOCK 750E CHAI CHEE ROAD 06-01 CHAI CHEE IND. PARK 1646 SINGAPORE REP. OF SINGAPORE Tel. : 65 2490 100</p>	<p>REPUBLIC OF SOUTH AFRICA HONEYWELL Southern Africa PO BOX 138 Milnerton 7435 REPUBLIC OF SOUTH AFRICA Tel. : 27 11 805 12 01</p> <p>ROMANIA HONEYWELL Office Bucharest 147 Aurel Vlaicu Str., Sc.Z., Apt 61/62 R-72921 Bucharest ROMANIA Tel : 40-1 211 00 76/ 211 79</p> <p>RUSSIA HONEYWELL INC 4 th Floor Administrative Building of AO "Luzhniki" Management 24 Luzhniki 119048 Moscow RUSSIA Tel : 7 095 796 98 00/01</p> <p>SLOVAKIA HONEYWELL Ltd Mlynske nivy 73 PO Box 75 820 07 BRATISLAVA 27 SLOVAKIA Tel. : 421 7 52 47 400/ 425</p> <p>SPAIN HONEYWELL S.A Factory Josefa Valcarcel, 24 28027 MADRID SPAIN Tel. : 34 91 31 3 61 00</p> <p>SWEDEN HONEYWELL A.B. S-127 86 Skarholmen STOCKHOLM SWEDEN Tel. : 46 8 775 55 00</p> <p>SWITZERLAND HONEYWELL A.G. Hertistrasse 2 8304 WALLISELLEN SWITZERLAND Tel. : 41 1 831 02 71</p>	<p>TURKEY HONEYWELL Otomasyon ve Kontrol Sistemlen San ve Tic A.S. (Honeywell Turkey A.S.) Emirhan Cad No 144 Barbaros Plaza C. Blok Kat 18 Dikilitas 80700 Istanbul TURKEY Tel : 90-212 258 18 30</p> <p>UNITED KINGDOM HONEYWELL Unit 1,2 &4 Zodiac House Calleva Park Aldermaston Berkshire RG7 8HW UNITED KINGDOM Tel : 44 118 906 2600</p> <p>U.S.A. HONEYWELL INC. INDUSTRIAL PROCESS CONTROLS 1100 VIRGINIA DRIVE PA 19034-3260 FT. WASHINGTON U.S.A. Tel. : 1-800-343-0228</p> <p>VENEZUELA HONEYWELL CA APARTADO 61314 1060 CARACAS VENEZUELA Tel. : 58 2 239 0211</p>
--	---	---	---	---

Honeywell

Industrial Measurement and Control
Honeywell
1100 Virginia Drive
Fort Washington, PA 19034