

# CALCOMMS™ Manual

CAL 3300 and 9300  
Autotune Temperature  
Controllers

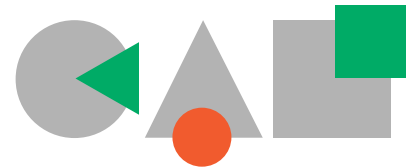

**CAL Controls**  
Temperature Controllers



# INDEX

## KEY TO PROGRAM ICONS

### OVERVIEW

(inside front cover)

### INSTALLATION/CABLING

RS232	1
RS485	2
Termination resistors	3
Bias resistors	4
RS232/RS485 features	5

### INSTRUMENT COMMS SETTINGS 6

### CONFIGURING INSTRUMENT COMMS SETTINGS 7-8

### INSTALLING CALCOMMS™ SOFTWARE 9-10

### GETTING STARTED 11

### CALCOMMS™ INSTRUMENT SCREENS 12

### PC COM PORT SETTINGS 13-14

### INSTRUMENT PARAMETER CONFIGURATION

### SOFTWARE ALARMS 15

### SETPOINT ADJUSTMENT 16

### INSTRUMENT CLONING 17

### SAVING SETTINGS TO FILE 18

### SECURITY LOCKOUTS 19-20

### LOGGING AND CHARTING 21-24

### LOG ON CHANGE 25-26

### EXPORTING LOG FILES 27

### TROUBLE SHOOTING 28

### GLOSSARY OF TERMS 29-30

### CAL CONTACT INFORMATION 32



# Key to Program Icons



Change comms settings & start monitoring



Toggle Modbus comms de-bug window



Add new instrument 3300



Add new instrument 9300



Arrange instruments in grid



Make instruments larger



Make instruments smaller



Set security locks



Add new chart recorder



Close program



Create new file



Open existing file



Export file in text format



Select units to record



Toggle grid density



Select background colour



Select primary grid colour



Select grid colour



Make chart bigger



Make chart smaller



Print chart recorder



Scroll chart up 100%



Scroll chart up 10%



Find chart zero



Scroll chart down 10%



Scroll chart down 100%



Expand verticle scaling range



Decrease verticle scaling range



Increase time/division



Decrease time/division

# OVERVIEW

**CALCOMMS™** is a graphic **WINDOWS™** based software package designed for PC supervision of CAL Model 3300 and Model 9300 controllers. It offers the capability of remote adjustment, instrument configuration, cloning, saving and retrieving instrument settings to files together with logging and charting in real time.

Communication uses the **MODBUS®** protocol via either a fully isolated **RS232** or **RS485** link depending on the number of instruments and the transmission distances involved in the application.

## PC Requirements

To gain the full benefit of **CALCOMMS** software, it is recommend that the PC is fitted with a Pentium processor and is running **WINDOWS 95** or **Windows NT** programs. A minimum of 16 Mb RAM is recommended to run the program, together with enough free hard disc space to meet logging requirements.

This manual assumes that a mouse or other pointing device will be employed, but alternatively or in an emergency the standard **WINDOWS** key convention can be used to operate or close the program.

Because the controllers are "stand alone" they do not need PC supervision for their normal function, and will continue to control the process unaffected by failure of any part of the communications loop.

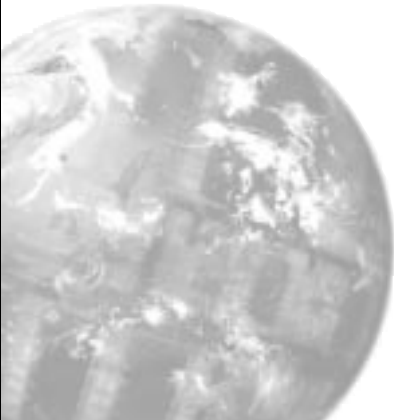

# Installation/Cabling

## RS232 Connections

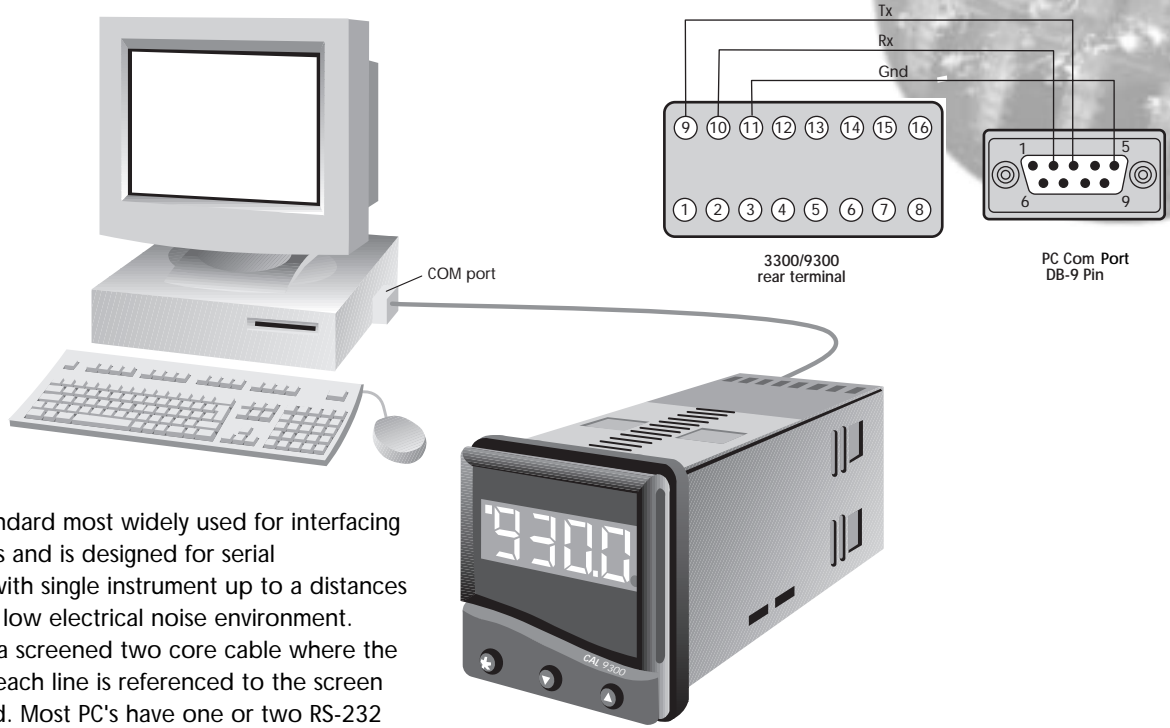

**RS-232** Is the standard most widely used for interfacing peripherals to PC's and is designed for serial communications with single instrument up to a distances of 15 metres, in a low electrical noise environment. Connection is via a screened two core cable where the voltage signal on each line is referenced to the screen which is grounded. Most PC's have one or two RS-232 compatible ports fitted as standard.

# Installation/Cabling

## RS485 Connections

**RS-485** Is a half duplex serial communications link and is the standard most commonly used for industrial applications due to it's high noise immunity and multi-drop capability. It enables a PC to communicate with up to 32 instruments over distances up to 1200 metres, and requires the addition of an RS-485 interface card, or a separate RS-232/485 converter.

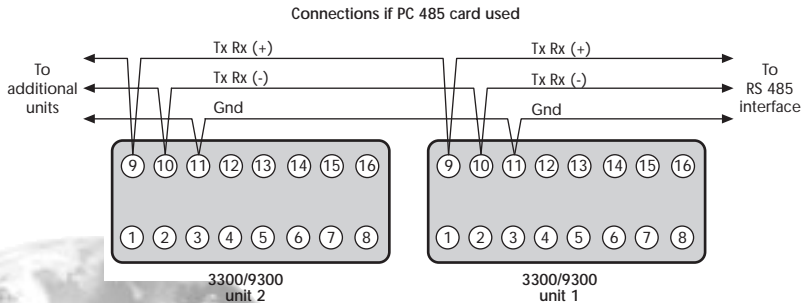

To RS 485 Interface  
Either plug in board or  
separate converter



Daisy chained connections

Note:  
Where separate RS 485  
interface is used, refer to  
manufacturers instructions for  
connection details

Each **RS485** interface has specific connection and termination biasing requirements which will be detailed in their installation instructions. The general principles are as follows.

**Terminations** Because each wire is a transmission line, it must be properly terminated to prevent reflections. Where multiple instruments are daisy-chained together, a 120 ohm terminating resistor should be fitted at the connection to the PC and to the last instrument in the chain.

## Termination resistors

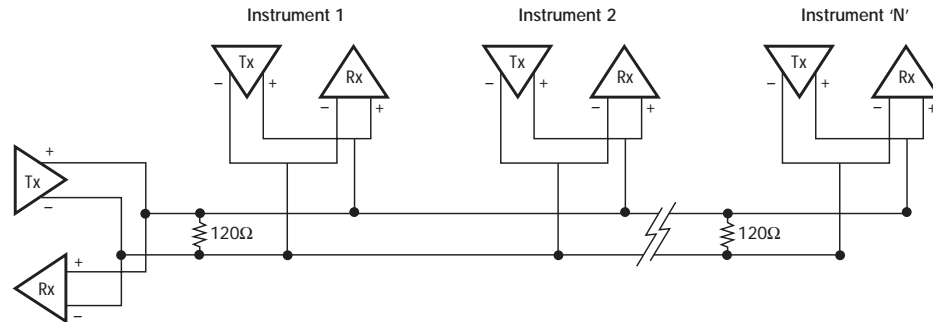

# Installation/Cabling

**Bias resistors** When transmission lines are not transmitting, they remain in an indeterminate state which can allow receivers to receive invalid data bits due to electrical noise on the cable. To prevent this, the the lines should be forced

## Bias resistors

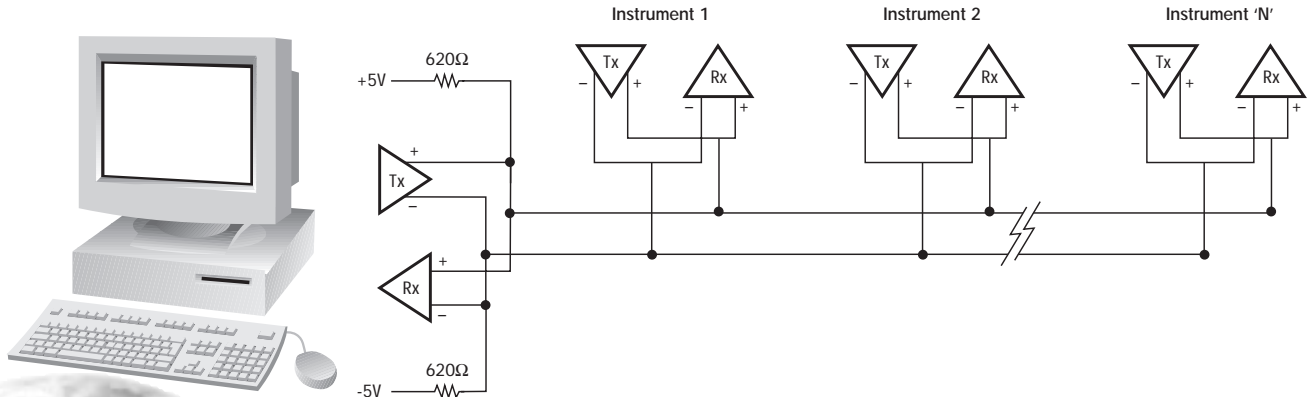

into a known state by fitting two 620 ohm bias resistors to one point (node).

If an RS-485 interface card is being fitted to the PC, separate bias resistors may not be needed because they may already be fitted to the card. Check the manufacturers specification.



# Installation/Cabling

For a continually updated list of recommended RS-485 interface cards, contact CAL.

Feature	RS232	RS485
Type of transmission lines	Unbalanced	Differential
Maximum number of drivers	1	32
Maximum number of receivers	1	32
Maximum cable length	15M	1200M
Maximum data rate	19.2Kb/sec	19.2Kb/sec
Maximum CMV	+/- 25V	+ 12 to - 7V

Table lists the features of both **RS-232** and **RS-485** standards.

**Cable** To ensure data integrity over long transmission distances, it is recommended that good quality RS-485 cable is used.

**Recommended:** RS485: Belden 9841, RS232: Belden 9501 available from most leading distributors, and stocked by CAL.



# Instrument Comms Settings

Immediately after power-up, both instrument, and PC comms settings need to be made compatible before communication between them is possible. Instrument defaults are shown below together with the available options.

## ! Addr

(Address) This is a unique identification number that must be allocated to each instrument connected to the network.  
**Default = 0.** Options; *1 to 247*

## baud

(Baud rate) The setting determines the serial communication data transmission rate in bits/sec, and must match the PC settings  
**Default = 9600.**  
 Options;  
*1200;2400;4800;9600 and 19200*

## data

(Data) Sets the transmission format, and must match the PC settings.

### Data Format Table

Settings	Start bits	Data bits	Parity	Stop bits
Default	1	8	n (none)	1
Option 1	1	8	e (even)	1
Option 2	1	8	o (odd)	1

## dbuG

(Debug). Commissioning and troubleshooting aid. Display shows when the instrument is transmitting or receiving data by rapidly flashing the three horizontal segments of the first and last digit of the display.

**First digit = Tx; last digit = Rx**  
**Default = Off.** Options *off; on*

**Only use dbuG during commissioning or trouble-shooting because it shares display segments and therefore corrupts the normal display.**

# Configuring Instrument Comms Settings

*This should also be done immediately after power-up, and is only possible from the instrument front panel.*

On power-up the controller will display the self test sequence followed by Alternating **INPE** and **nonE**

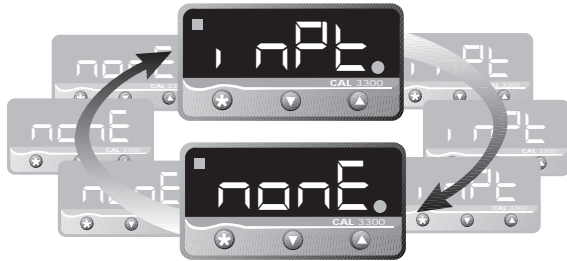

**Note:** During the following procedure the display will revert to alternating **INPE** and **nonE** after 60 seconds of keying inactivity, but will retain any settings already completed. Should this occur, or in the event of becoming "lost" in the program, please start again from the alternating **INPE** and **nonE** display

## To select Level C (communications settings)

Press **▼** once display alternates **LEUL** and 5  
Press and hold **✱** and press **▼** five times to reach level C  
display alternates **LEUL** and C

**Note:** Level C is only visible when the comms interface board is fitted to the unit



## To set up Instrument comms address

Press **▲** once display alternates **Addr** and 0  
Press and hold **✱** and press **▲** to index to chosen address number (1 to 247)

**Note:** In the absence of any conflicting information the following comms settings should be left as the default values. (see details on page 6).

## To read or adjust comms settings

### Baud rate

Press **▲** once display alternates **bAud** and 9600  
(Default setting)

Press and hold **✱** and use **▲** or **▼** keys to select preferred value

### Data format

Press **▲** once display alternates **data** and 18n1 (Default setting)

Press and hold **✱** and use **▲** or **▼** keys to select preferred setting (see table page 6)

### Debug setting

Press **▲** once display alternates **dbug** and oFF (Default setting)

Press and hold **✱** and use **▲** key to select **on**

# Configuring Instrument Comms Settings

To enter settings into memory

Press and hold ▲ and ▼ for 3 seconds display alternates

 and *none*

To check settings; repeat the above procedure

The unit is now ready to be configured from the PC.

**Note:** Where more than one instrument is connected to the system, it is useful at this point to list them by location, title and comms address. The list can then be used as a reference to ensure that the the instruments are given the same identity when configuring the comms link from the PC.

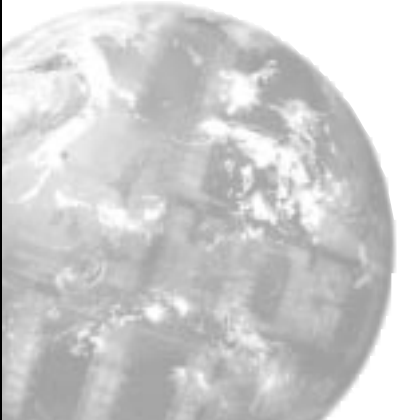

# Installing CALCOMMS™ Software

1. From the Windows screen, click the **Start** button and point to **Settings**.
2. Click the **Control Panel** icon then double click on the **Add/Remove Programs** icon.
3. Click on the **Install** button and follow the screen prompts.



When installation is complete, **CALCOMMS** should appear in the Windows program menu.

*To Uninstall CALCOMMS, repeat the above procedure.*

To create a shortcut and put the **CALCOMMS** icon on your desktop

**Right click**  
**Point**  
**Type**

anywhere on the desktop.  
to **New** then **Click** **Shortcut**  
in **Command line** panel using syntax  
exactly as shown:  
"c:\Program Files\Cal Controls\  
Cal Comms\Calcomms.exe"

**Click**

**Next**  
In **Select name for shortcut** panel the  
text will appear; **Calcomms.exe**  
**Finish**, and this will place the title and  
the **CALCOMMS** icon on the desktop.  
Alternatively;

**Click**

**Overtyp**

your preferred title in the **Command line**  
panel then

**Click**

**Finish.**

**Check**

that the **CALCOMMS** logo appears  
correctly titled.

An alternative method of defining the file path in the **Create shortcut** window is to use the **Browse** function to find **Calcomms.exe**

**Click**

**Browse**

**Double Click**

**Program Files** folder.

**Double click**

**Cal Comms** folder

**Double click**

**Calcomms.exe** logo, then

**Click**

**Next**, then

**Click**

**Finish**, and check the **CALCOMMS** icon  
and title.

### Installing Comms Software (continued)

To delete a shortcut,  
Click on the desktop icon then press the delete key



# Getting Started

Start the program running from either;

- a. Windows Start menu
- b. Shortcut icon (if created during **CALCOMMS** installation)

This will open the **CALCOMMS** window. The screen can be sized using standard Windows controls.

**Note;** As **CALCOMMS** is a supervisory program it is not designed to be minimised



## ADDING INSTRUMENTS



Click the appropriate **Add New Instrument** icon to call up the type and number of instruments that are to be shown on the screen. Each click produces a new instrument which can also be deleted by using the **Close button** in the instrument title bar immediately above the instrument screen. Mixed instrument types can be displayed on the same screen.



Click the **Arrange Instruments in a grid** icon and use the screen prompt to arrange them in the preferred layout.



Click the **Make Instruments Larger** icon or;



Click the **Make Instruments Smaller** icon to size them as required.

See screen illustrations overleaf.

# CALCOMMS Instrument Screens

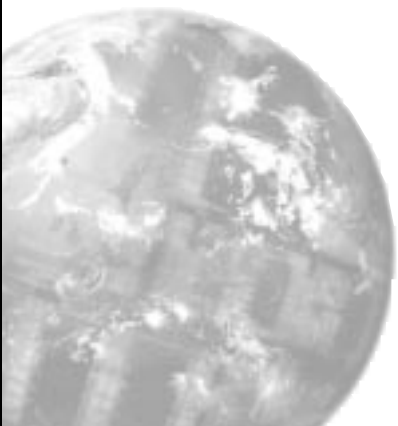
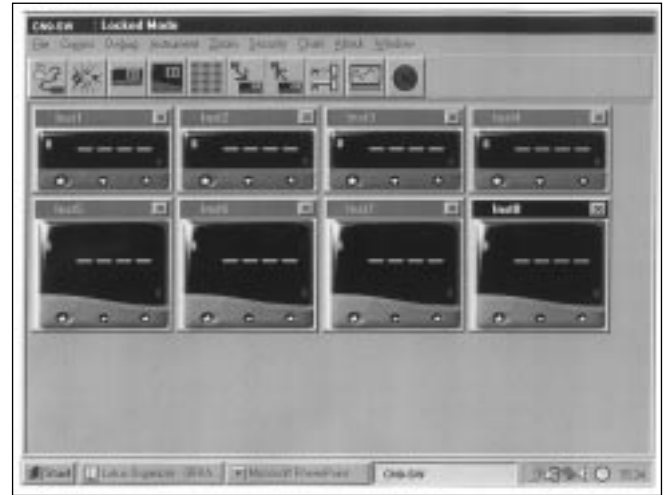
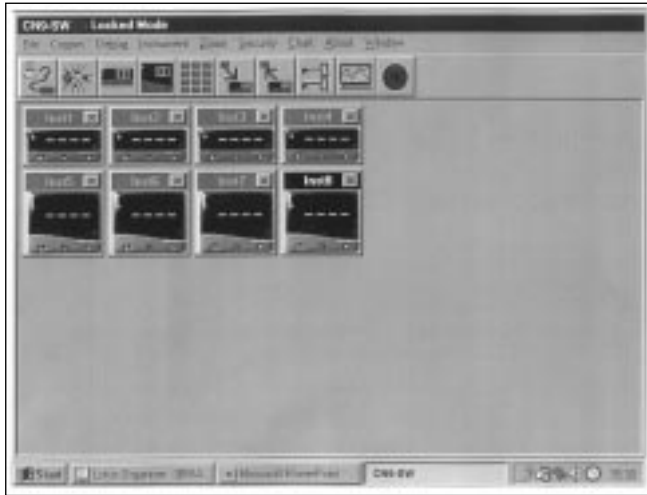



# PC Com Port Settings

When the instruments are positioned on the screen, they are automatically numbered in sequence **Inst.1, Inst.2** etc. Each one can be individually named in it's own title bar, and **must** be given the same unique comms address (**1 to 247**) given manually to the instrument during the **Instrument Set-Up** procedure. *(CHECK your list!)*

- Right click** in the display window of **Inst.1** to open the **Internal Parameters for Inst1** screen. If not already in User Level;
- Click Point** **User Level** tab to open page, then; to **instrument/name** and if required, change **inst1** by typing in a preferred instrument title.
- Check** **Modbus address** and if necessary correct it to the given comms address (**1 to 247**) by using the spin buttons or by swipe and type. *(CHECK your list!)*
- Click** on **Update** button and then **Yes** button in **Confirm / Update** Instruments with new parameters panel.
- Instrument 1** should now have the correct comms settings. The above procedure **must** be repeated for all instruments on the screen before starting **Instrument Parameter Configuration**.

**Note;** If using an **RS232** or **RS485** converter plugged into comm port 1 or comm port 2, the **CALCOMMS** software will

automatically configure the com port settings. Where an **RS485** PC card is being used, refer to the manufacturers installation instructions.

To open communication with the instruments in preparation for **Instrument configuration**.

Click



**Change comms settings and start monitoring icon**, then **select the comms port** that the instruments are connected to. (eg comm 1 or comm 2) then **Select Baud rate** to match the instrument settings, (eg 9600) then **Select Data Frame** to match the instrument settings, (eg 18n1)

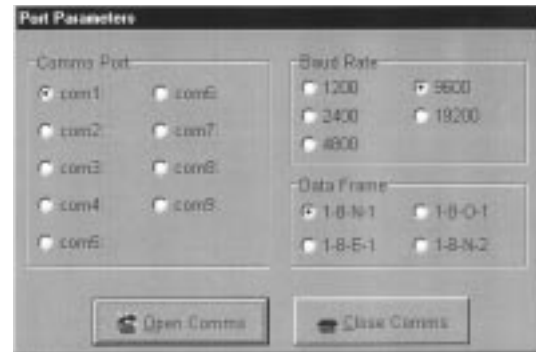

Click

**Open Comms** button

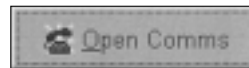

## PC Com Port Settings (continued)

**Wait!!**

For update to be fully completed by observing the **Uploading bar** turning from red to green in the **CALCOMMS Instrument** screen.

**This may take several seconds.**

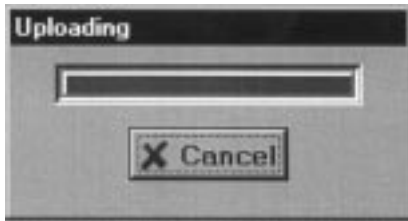

**Check**

**Virtual** instrument display readings against **real** instrument readings.

If the check is satisfactory, proceed with **Instrument Parameter Configuration**

# Instrument Parameter Configuration

The instrument(s) will not be operational until configured with the following basic settings.

- \* Sensor type
- \* Units of measurement
- \* Allocation of output devices to the main output SP1 and second output SP2

To configure the basic settings to Instrument 1

- Right Click** in the display window of **Inst.1** (or new given name) to open the **Internal Parameter** screen
- Click** **Level 2** tab to open page, then
- Click** **Input sensor** box, and select required sensor from the drop down menu (eg **K**)
- Click** **Process unit** box, and select required unit from the drop down menu (eg **°C**)
- Click** **Level 3** tab to open page, then
- Click** **SP1 output device** box, and select choice of output device from drop down menu (eg **rLy**)
- Note:** That **SP2 output device** box registers the alternative output device (eg **SSd**) and if OK, **Click the Yes button** to confirm selection.
- Click** **User Level** tab to open page, and enter a setpoint value in **Set Point 1/SP1 Value** box using spin buttons or swipe and type.

**Check** The **Enable Display Mimics** box if you want the **virtual** instrument to mimic all **actual** instrument displays as well as reading setpoint and process values.

**NB** This may slow down communications and should only be used if it serves a useful purpose.

## SOFTWARE ALARMS

This feature provides a screen alarm indication if the measured value falls below the **low alarm** and/or rises above the **high alarm** settings. The alarm appears as a red band across the lower fascia of the instrument.



## Instrument Parameter Configuration (continued)

### To set Software Alarms (in User Level)

- Adjust** Spin buttons in Low Alarm/ High Alarm boxes to set the required high/low level
- Check** The **Enabled** boxes.

### TO ENTER THE ABOVE INSTRUMENT PARAMETER SETTINGS

- Click** on **Update** button and then **Yes** button in **Confirm/Update Instruments with new parameter** panel.

- Wait** For **update to be fully completed** as indicated by the **Uploading bar** turning from red to green after it temporarily appears in the **CALCOMMS Instrument** screen.

**This may take several seconds.**

After a few seconds more the Heat-On LED in the top left hand corner of the **Inst.1** screen will light indicating that the power is applied to the output.

**Instrument 1** will control with factory **PID** settings and pre-set **proportional cycle** times. For optimum performance the instrument may require **Tuning** to match the characteristics of the application. For full instruction in setting the controller functions, please consult

the main manual. **Autotune** routines can be found on page 7.

## SETPOINT ADJUSTMENT

During normal use, instrument setpoints can be adjusted from the **CALCOMMS instrument** screen, by using the three buttons shown on the virtual instrument lower fascia.



★ button highlighted with red circle in program

- Click** The **★ button**, and while the red circle shows around it, click either the **▲** or **▼** button to increase or decrease the setpoint value. This setting will be implemented when the red circle disappears after a few seconds.

**Note:** When more than one instrument is being configured, the outputs of the other instruments can be temporarily turned off using the **ParK** option of the  **tune** function in level 1.

# Instrument Cloning

When a satisfactory instrument configuration has been achieved, either from the initial configuration with the basic **parameter** settings, following Autotune or other further adjustments, these settings can be **cloned** to other instruments on the network or saved in a **file** for later use. Suites of settings of all the instruments in an application can similarly be **saved to a file** making it possible to re-configure all of the instruments on a machine or process in a matter of seconds, to optimise them to different task.

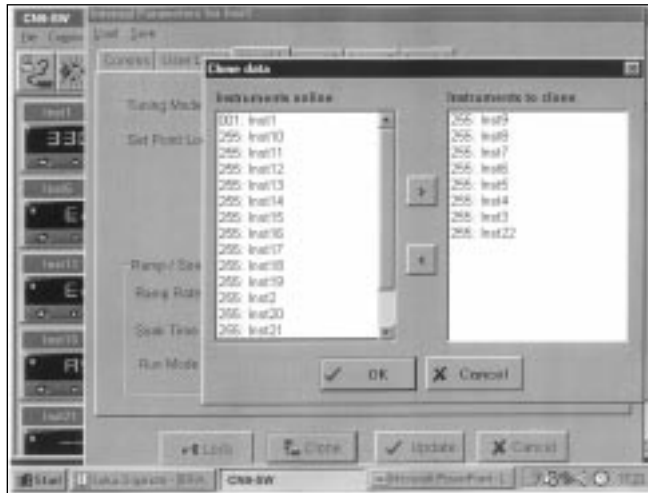

**Cloning Settings** to another instrument on the bus.

**Right Click**

in the display window of the instrument that settings are to be **cloned from**.

**Click**

the **clone** button in any of the pages of the **Internal Parameters for instrument (n)** screen to call up the **Clone data** page. The **Instruments on line** panel will list all of the instruments on line by it's Modbus address and either the default instrument number or name/location given during **Instrument Comms Setting** procedure.

To transfer an instrument or group of instruments to the **Instruments to Clone** panel;

**Click**

anywhere on instrument title, to highlight, or

**Click/hold**

a group of instrument titles, then

**Click**

the button to transfer the highlighted instruments to the **Instruments to clone panel**, then

**Click**

the **OK** button to clone them with the settings from the original instrument.

# Saving/Retrieving Instrument/Application Settings

## Saving the settings of a single instrument

- Click** **Save** in the menu bar of the **Internal Parameters for Inst.n** screen
- Type** Your **filename** in the **File name** box
- Click** the **Save** box

This will save the instrument settings to an instrument file with the extension **.ins**

## Opening an existing instrument file

- Click** **Load** in the menu bar of the **Internal Parameters for Inst.n** screen
- Click** the **Yes** button in the **Confirm** panel to **Load inst.n from file?**

This will load instrument n settings to the new instrument.

## Saving an Application File

In the **CALCOMMS** Instruments screen

- Click** **File** in the menu bar, then **Save Application** from the menu.
- Type** Your new **filename** in the **File name** box.
- Click** **Save**

This will save the settings of **all the instruments** on the screen to an application file with the extension **.app**. Check that the file is correctly named **Yourtitle.app**.

## Opening an Existing Application File

- Click** **File** in the menu bar, then **Open Application** from menu
- Click** **File name** to select application from the list then click **Open**

This will automatically configure the instruments to the settings saved in the selected file

## Starting a New Application File

- Click** **File** in the menu bar and select **New Application** from menu
- Click** **Yes** to confirm **Start a new application**

**Note:** When instrument settings are loaded from an application file, remember to re-start comms

# Security Lockouts

When the instrument parameters have been established you may wish to password protect the settings against accidental or unauthorised adjustment. It is possible to make individual protection for each instrument function at each level, and for each instrument on the network



Please study the lock hierarchy diagram below before implementing your security strategy.

When correcting errors, start again from supervisor level, **lock none**, and clear the locked settings in the correct hierarchical sequence

## Lock Hierarchy

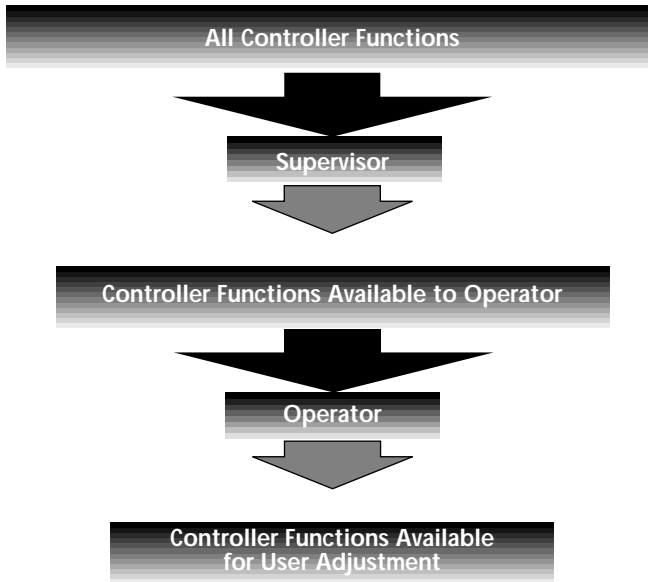

### Supervisor

All of the controller functions are available to the supervisor who can deny adjustment of any number of them to lower levels in the hierarchy. These settings will be protected by the supervisor's password.

### Operator

The operator can adjust all controller functions not locked by the supervisor, and can in turn lock any of these to deny adjustment to a user, and then protect them with the operator's password.

### User

Any remaining functions are available for adjustment by the end user. These functions can be locked and unlocked without the use of a password.

# Lock Hierarchy

To implement your security lockout strategy, begin from the **CALCOMMS instrument** screen, supervisor mode.

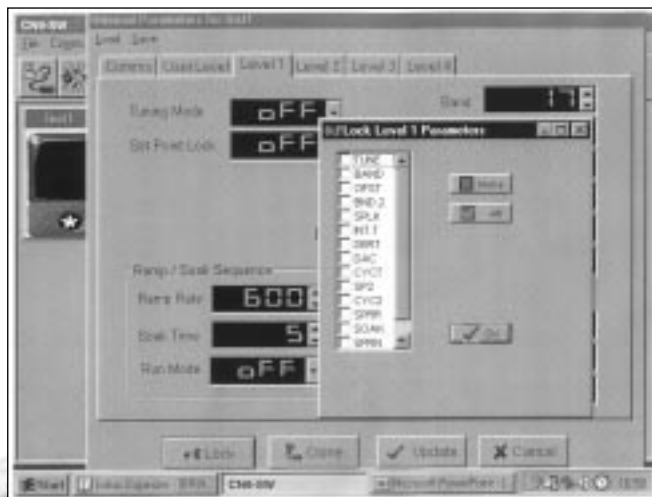

- Right click in the display window of **Inst.1** to open the **Internal Parameters** for
- Click **the tab** for a level that contains any settings that you wish to protect, and
- Click the **Lock** button, and in the **Lock User Level Parameter** window,
- Check either the individual boxes of all the

parameters you want to lock, or the **All** box or the **None** box.

- Click **OK** then
- Click the tab for the next level, and repeat the procedure until all levels of **Inst.1** have been protected.

Repeat for all of the remaining instruments on the network, then return to **CALCOMMS instrument** screen.

- Click  **double lock** icon in the menu bar to bring up the **Password** panel, then

- Click the arrow in the **User type** box and select **Locked** from the drop down menu.

- Type your password in the **Password** box and click **OK**. The selected levels of the selected instruments are now locked and protected by your password which can be changed at any time using the **Change** feature.

**NB:** Once communication has been established and routine function adjustments under PC control, **it is highly recommended that the instrument controls are manually locked to prevent unauthorised local adjustment**. When locked, it will still be possible to make adjustments from the PC.

**If you forget your password, please contact CAL**



# Logging and Charting

The **CALCOMMS** software is capable of logging readings from up to 32 instruments which it stores in data files. The data can be exported into text files which will enable the data to be displayed in c.s.v. format, as columns of readings against dates and times, for each of the 32 instruments. In addition, the readings of up to 12 of the instruments can be presented graphically and in colour, by the chart recorder facility.

*As in other sections of the manual, it is assumed that a mouse or pointing device is being used. Where only a keyboard is available, the standard **Windows** key conventions can be used to operate the program.*

## GETTING STARTED

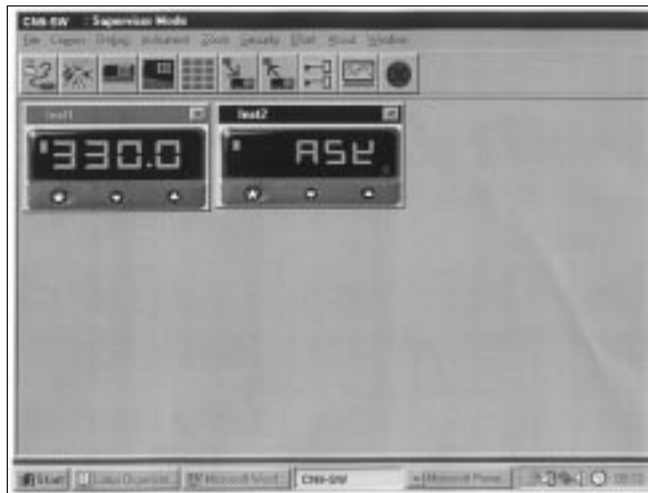

From the **CALCOMMS** instrument screen.

Click



the **add new chart recorder** icon in the menu bar, and in the **Chart recorder** screen;

Click



the **create new file** icon, and in the **File name** box of the **Select File to Create** panel;

Type

your chosen file name, then Click the **Save** button.

Click

In the **Select Units to Chart** screen; to highlight all of the units that are to be logged from, in the **Available instruments** list.



### Logging and Charting (continued)

- Click the transfer button to list them in the **Instruments to record** table. For each instrument to be charted from, **double click** in the **Plot?** column to change the **No** to **Yes**.
- Double click** in each instrument colour panel, and from the standard **Windows™** colour chart, select contrasting colours that will effectively display all of the instruments listed. Additional shades can be added

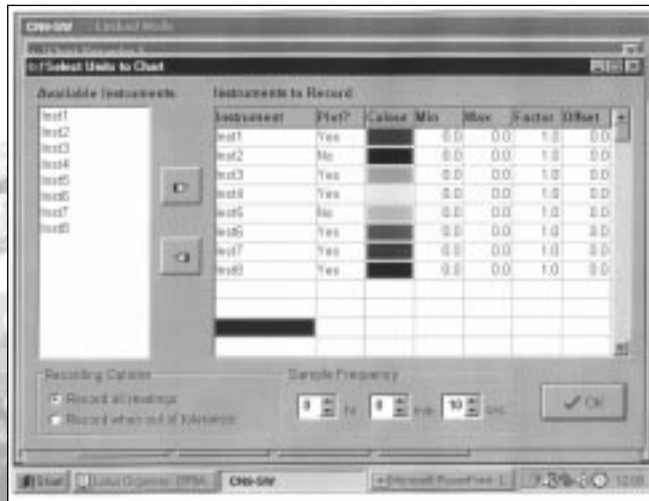

- using the **Add to Custom Colour** feature. the **OK** box in the colour screen.
- Click In the **Sample Frequency** panel, the **spin buttons** to set the log reading frequency.
- Click the **OK** button to open the **Chart Recorder** screen.
- In the **Chart Recorder** screen, check that the **Active File** panel shows the correct file name, then make the following chart recorder settings to suit your application, starting with the **Scaling** panel;

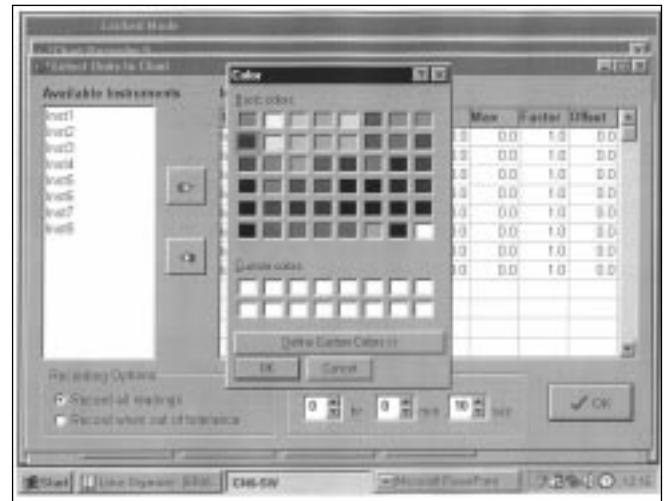

Click the **buttons** in the **deg C/F** box to set up a suitable temperature scale in the chart Y axis.

Click the buttons in the **time/div** box to set

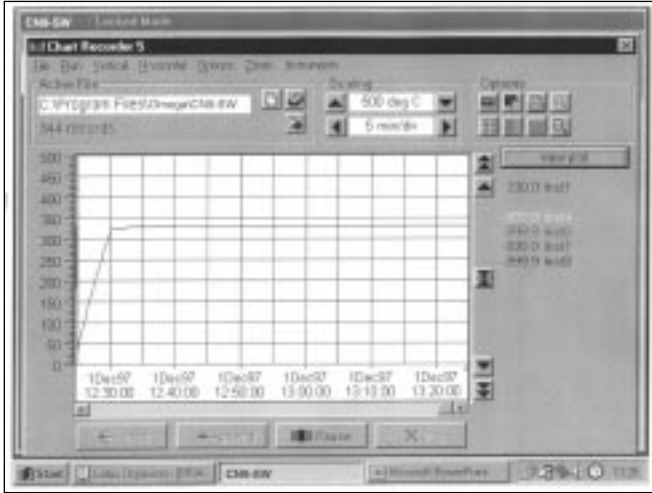
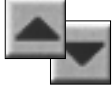



chart speed in the time interval per minor division of the X axis.

Click the **Start** button to commence logging and run the chart recorder with default chart settings.

**Note:** Chart scale settings are determined by the settings chosen for the first instrument (or instrument 1)  
**Traces can be vertically positioned on the chart by using the chart scroll buttons.**

Click  the buttons to move the chart **up** or **down** by 10%

Click  the buttons to move the chart **up** or **down** by 100%

Click  the button to **zero** the chart

The appearance and colours of the chart can be changed as follows;

Click  select **background colour** icon, and chose another colour from the colour chart.

Click  the **toggle grid intensity** icon to add minor divisions to the Y axis.

Click  the **select primary grid colour** icon to change the colour of the grid major divisions.

Click  the **select grid colour** icon to change the colour of the grid minor divisions.

**Note:** Because the chart is re-drawn after each plot, a setting of **less than** 5 minutes/div is recommended, to avoid extravagant use of system resources while logging. Longer settings can be used to review the full chart history in **view plot** mode.



Click the **make chart bigger** or **make chart smaller** icons to adjust the size of the chart on your screen.

Click in the **chart recorder** blue title band, and **drag** to adjust the position of the chart recorder on your screen. Repeat this for the **CALCOMMS instrument** screen, and trim both adjustments so that both are visible.

If you prefer using full screens for both chart and instruments, toggle between screens using the **instruments** menu bar

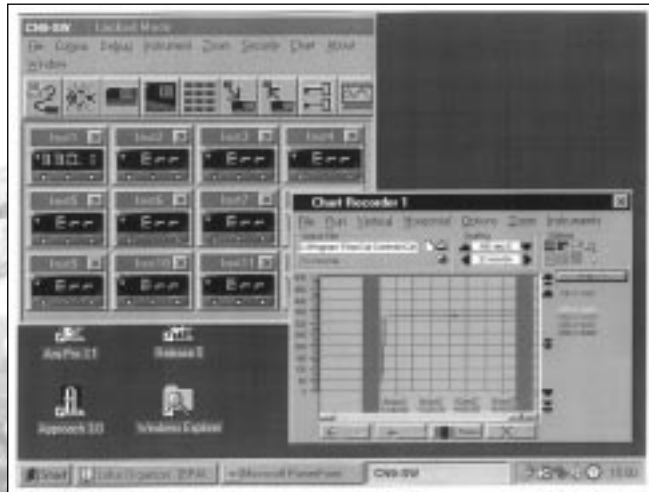

option in the **chart** screen and the **chart** option in the instruments screen.

- Click the **pause** button to stop logging and stop the chart recorder.
  - Click the **Resume** button to re-start logging and charting. Note that a grey vertical band appears on the right of the chart to signify the break in readings.
  - Click the **auto plot** button to pause the chart and allow the chart history to be viewed using the horizontal scroll bar controls. *(normal logging continues meanwhile)*
  - Click the **view plot** button to return to **automatic chart update state** and normal charting is resumed.
- During charting, the current value is displayed to the right of the chart, in the trace colour. When in **view plot** mode and **Click** to any point on the trace. A dashed vertical line will appear and cut the trace at this point, and the value will appear to the right of the chart in place of the current value.
- If used in auto plot mode the reading will be set to current value at the next plot.

# Other Logging and Charting Options

## LOG-ON-CHANGE (ONLY LOG/CHART OUT OF LIMITS READINGS)

This feature reduces the size of log and chart files by ignoring readings that are within adjustable specified limits. To specify the limits;

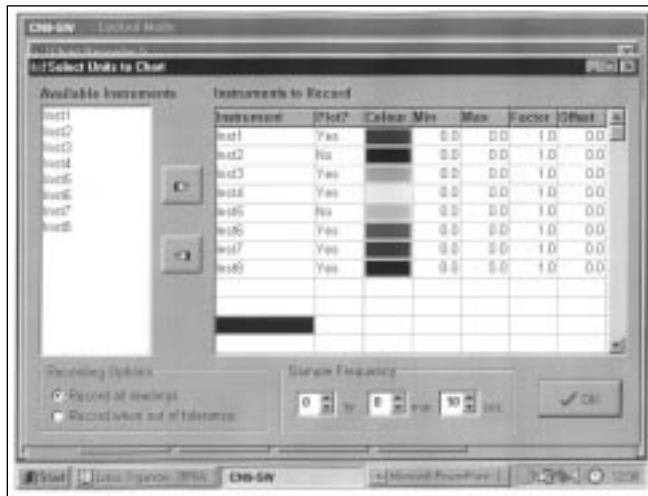

Double click

in the **inst.1 Min** column and enter the value **below** which readings are to be logged. Repeat in the **Max** column, and enter the value **above** which readings are to be logged.

Check

the radio button **record when out of tolerance**, and Click the **OK** button.

The chart will now only register **out of limits** readings which will be separated by grey vertical bands signifying periods of **in limit** readings. It will still be necessary to set the **Sample Frequency** buttons.

Check

the radio button **record all readings** to return to normal logging/charting.

## Factor and Offset adjustments

A **factor adjustment** can be made to enable readings of differing orders of magnitude to be charted on the same scale. For example, a X10 factor applied to ambient temperature readings would enable them to be charted alongside process temperatures of 200°/400°C - 400°/1470°F. Factor adjustments can be greater or less than one.

**Offset adjustments** can be applied to any trace to adjust its position with respect to the scale. For example, the readings from a particular instrument may be known to be 4° low due to poor siting of the sensor. An adjustment of +4 in the Offset column will remove this error.

## Sizing and positioning your chart

Click



to make the chart smaller or larger.

If required, it is possible to super-impose a small chart screen on top of or beside the **CALCOMMS** screen so that both are visible.

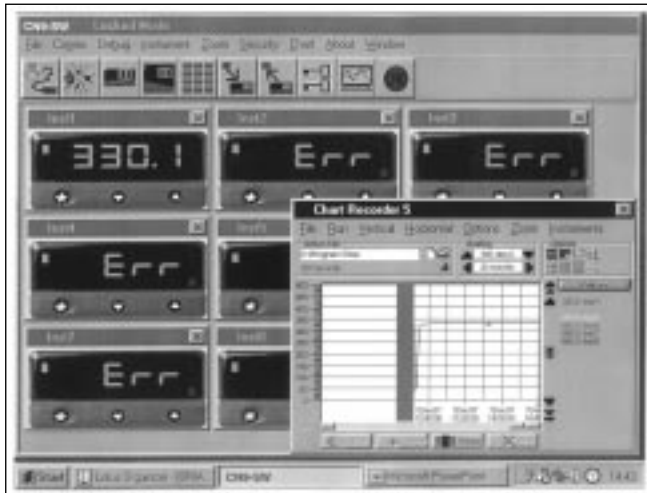

### Saving Charts

To stop recording

Click

Either the **close** button or from the menubar chose **File** then **Exit**. The file will automatically be saved with the name given earlier as **Givenname.cht**

Files can be recalled to view, or to add additional data using the **Append** feature.

Click



the **Open existing file** icon, and select the name of the file to be opened from the list in the file box.

Click

**Open** button.

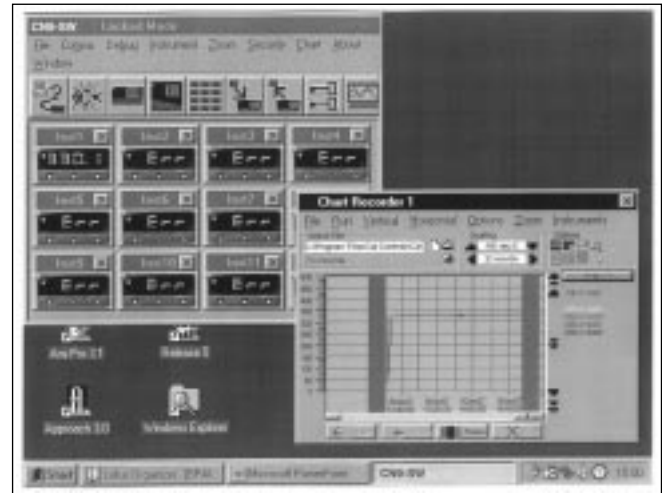

The chart recorder screen will open with the chart settings returned to default. If preferred, reset the chart to your original settings, then;

Click

**Append** button to add the new readings to the chart. The new readings will be separated by a vertical grey bar.

### Multiple Charts

It is possible to open a number of charts simultaneously. The menu will register the number of charts open under the **chart** heading. These can be arranged on the screen, in or out of view, and moved or sized as required.

# Exporting Log Files as Text Files

Log files can be exported as "Comma Separated Variable" (csv) text files, which appears as column of logged instrument readings, set against its time, date and line number.

In this form the data can be exported into other applications such as spreadsheets or data bases for use in the preparation of reports or other management documents.

To export data to a text file, in the **Chart Recorder** screen,

- Click  the **export file in text format** icon, and in the **Export Text File** screen, type your file name in the **File name** box.
- Click the **Save** button to save your file as a **Filename.txt** file

To check that your file has been correctly saved, open **Windows Explorer**

And from the **C:\** directory click **Program Files** then **CAL Controls** then **CAL Comms**

From the list contained under the filepath

**C:\Program Files\CALControls\CAL Comms\**

**Double click** Select **Filename.txt**

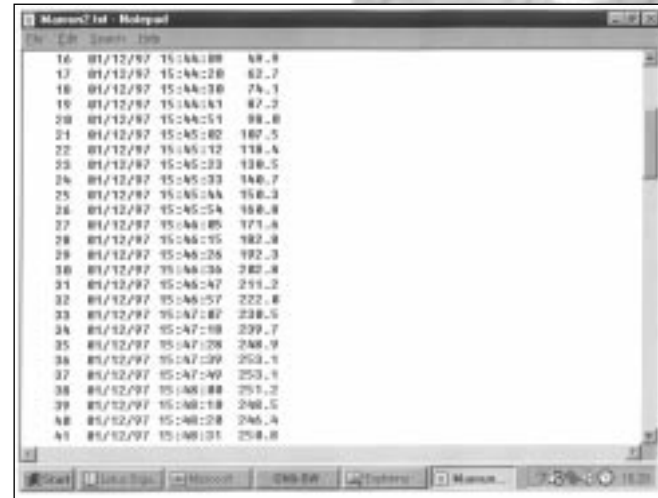

Depending on the size of the file, it will be opened in either **Notepad** or **WordPad**

## Printing Charts

Charts can be printed in full colour, depending on the specification of the printer.

From the **Chart recorder** screen use either the **print** icon or the **print** chart command from **Options** in the menu bar. This will open the Windows<sup>TM</sup> **print** screen. Click the **properties** button to select landscape setting. If changes in appearance are required, review the logging and charting section.

# Trouble Shooting

Error Message	Fault	Suggested remedy
	Comms error	Check that the comms address setting of the <i>real</i> and the <i>virtual</i> instruments are the same.
-----	Comms inactive	Make sure that comms is open. <b>Click Change comms settings and start monitoring icon.</b>

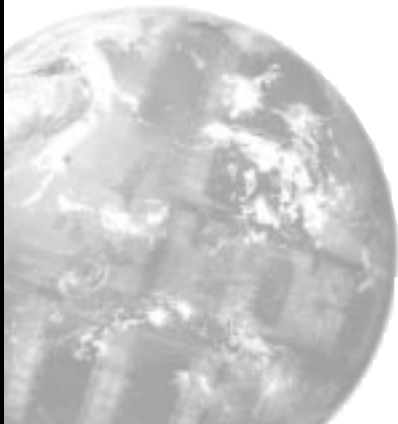



# Glossary of Terms

The following definitions apply to terms as they are used in this manual, and have been worded for ease of understanding. They may differ in detail to definitions found elsewhere.

<b>Address</b>	The unique number given to each instrument on the network that enables the PC to transmit individual instructions, and receive individual data from it.
<b>Application</b>	In this manual it defines the application of an instrument or group of instruments to control temperatures or other variables on a machine or process.
<b>Application file</b>	The stored settings of all of the instruments on a machine or process.
<b>Baud</b>	Serial communication consists of a stream of on/off signals called bits. Baud rate is a measure of the speed of communications in bits/second.
<b>Bus</b>	The electrical connection linking together the instruments and the PC.
<b>Charting</b>	Placing logged readings on a graph format to form a continuous trace of readings where the vertical or Y axis measures the magnitude of the reading and the horizontal or X axis measures elapsed time.
<b>Cloning</b>	Copying settings or groups of settings from one instrument to another.

<b>Comms</b>	Abbreviation of serial communications.
<b>Daisy chain</b>	The method of connecting instruments together.
<b>Data format Functions</b>	Defines the structure of the message. The main features available in the controller.
<b>Icon</b>	Small picture on a PC screen that describes a CALCOMMS function that can be clicked on to open or close the function.
<b>Level</b>	The instruments' functions are grouped on five levels of adjustments for ease of use and protection.
<b>Logging</b>	Datalogging; Recording readings against time and or date, into a file.
<b>Modbus</b>	Generic name given to the format (protocol) that defines the structure of the coherent groups of signals in serial communications.
<b>Multi drop</b>	When several instruments are connected together on a network using RS 485 standard.
<b>Options</b>	The choice of settings for the Functions.
<b>Password protect</b>	The arrangement that enables the user to lock the system settings against unauthorised adjustment with the use of a word or code.

Continued over the page

# Glossary of Terms

## Glossary of Terms (continued)

<b>P.C.</b>	Personal computer, desktop or laptop.
<b>Protocol</b>	See Modbus.
<b>Radio button</b>	A PC "screen" switch shaped like a push button that can be clicked on ☉ and off ○
<b>RS232/RS485</b>	Sometimes EIA232/EIA485 defines the two standards for serial communication. More detail can be found under Installation/Cabling.
<b>Serial Link</b>	Another name for the wiring between two communicating devices.
<b>Virtual Instrument</b>	Image of the instrument on the PC screen.

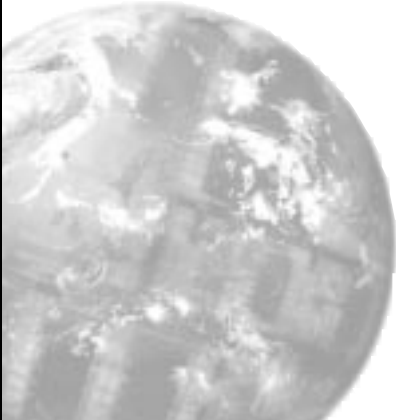

**Copyright CAL Controls Ltd. 1997**

Not to be reproduced without prior written permission from CAL Controls Ltd. Whilst every effort has been made to ensure the accuracy of the specifications contained in this manual, due to our policy of continuous development, CAL Control Ltd. reserves the right to make changes without prior notice.



## **CAL Controls**

Temperature Controllers



### **CAL Controls Ltd**

Bury Mead Road, Hitchin, Herts, SG5 1RT. UK  
Tel: + 44 (0)1462-436161 Fax: + 44 (0)1462-451801  
email: [support@cal-controls.co.uk](mailto:support@cal-controls.co.uk)  
<http://www.cal-controls.com>

### **CAL Controls Inc**

1580 S. Milwaukee Avenue, Libertyville, IL 60048. USA  
Tel: (847) 680-7080 Fax: (847) 816-6852