

Prices for reference only. Call Lesman sales or visit Lesman.com for current pricing.

Lesman

INSTRUMENTS • VALVES • CONTROLS

COMBUSTION AND FLAME SAFETY SOLUTIONS

combustion control systems • flame safeguards & detectors • fuel trains • heat exchangers • ignitors • industrial burners • mechanical safety switches • ratio & flow control • shut off & vent valves • actuators

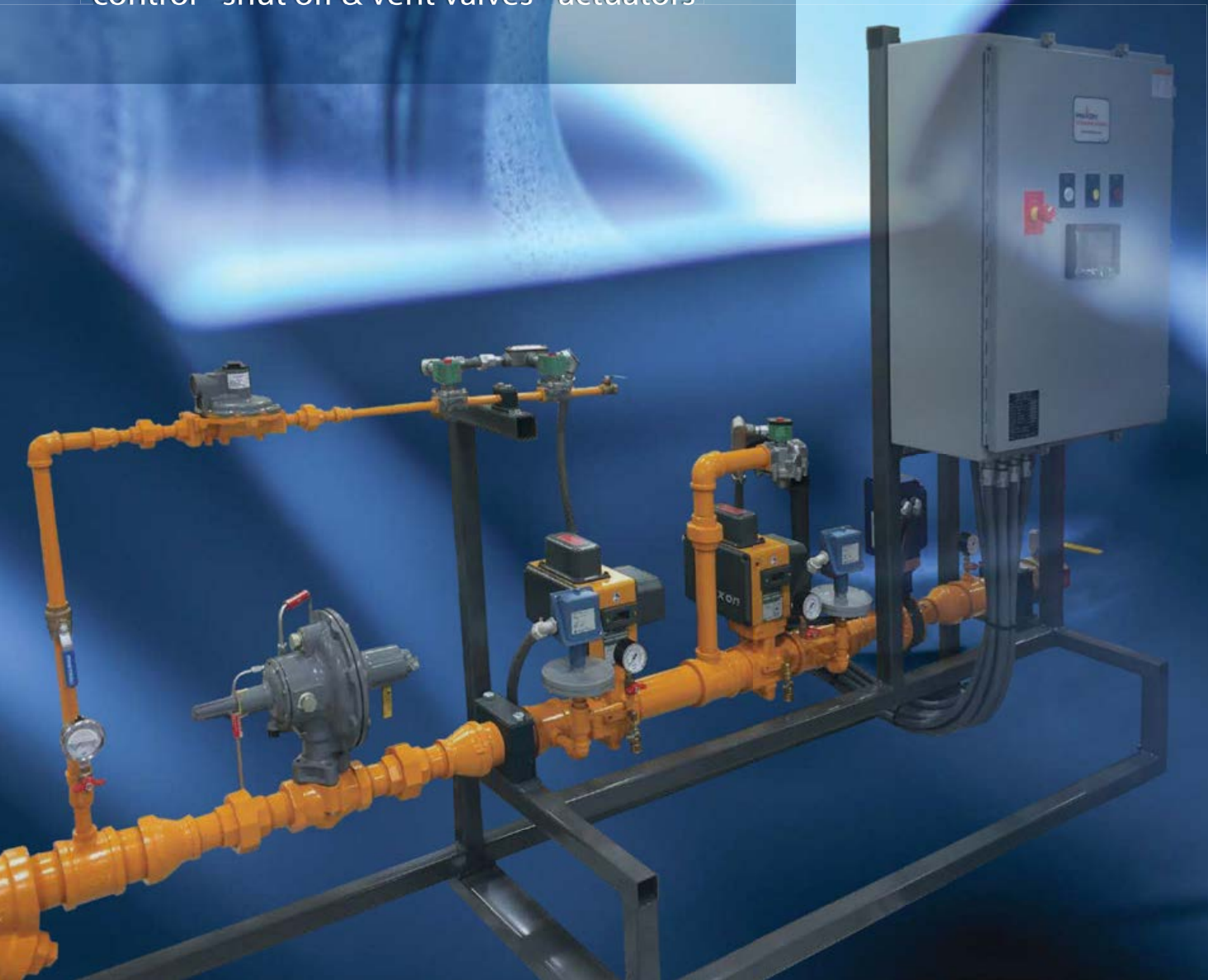

What's Inside?

See
Page

Air/Fuel Ratio Control	24-27
Combustion Air Blowers	40
Combustion Efficiency and Gas Detection	45-47
Flame Safety Control Systems	6-23
Fuel Train System Components	42-44
Industrial Burners	38-39
Integrated Combustion Management Systems	4-5
Pressure Controls and Switches	37
Valves and Actuators	26-36

Prices in this catalog are current at the publication date, and are subject to change without notice. Due to manufacturer agreements, some products in this catalog may not be available in all markets or geographic areas.

We stock combustion components



**NORMALLY
AVAILABLE
FROM STOCK**

Look for the  for popular models normally available from Lesman stock, and ready to ship within 24 hours.



Pre-Assembled or Custom OVENPAK System Solutions

Call 800-953-7626 for details.

Contact Us

Corporate Office: 135 Bernice Dr · Bensenville, IL 60106

Branch Office: 5160 N 125th St · Butler, WI 53007

www.Lesman.com | sales@lesman.com | 800-953-7626

No Project Too Big or Small

- Are you experiencing nuisance shutdowns on your burner system?
- Are you having trouble maintaining temperature in your combustion chamber?
- Is your system using more energy than before to do the same job?
- Are you confident in the safety of your combustion system?

Lesman can help you with replacement components, upgrades or retrofits, and new combustion systems and fuel trains.

Contact our factory-trained sales team at 800-953-7626.

Custom Control Panels Designed for Your Application

**Wired,
powered,
ready to
install!**



Honeywell's engineered systems team can design completely integrated control panels to suit your combustion control needs, including burner management and fuel air ratio control. All are built in a certified UL 508 panel shop and come pre-wired and pre-tested.

These heavy duty Hoffman™ panels are suitable for use in most environments and applications. They're ready to install, right out of the box, so installation time and errors are minimized, and downtime is reduced.



Typical Single Burner Furnace With Flame Safety System

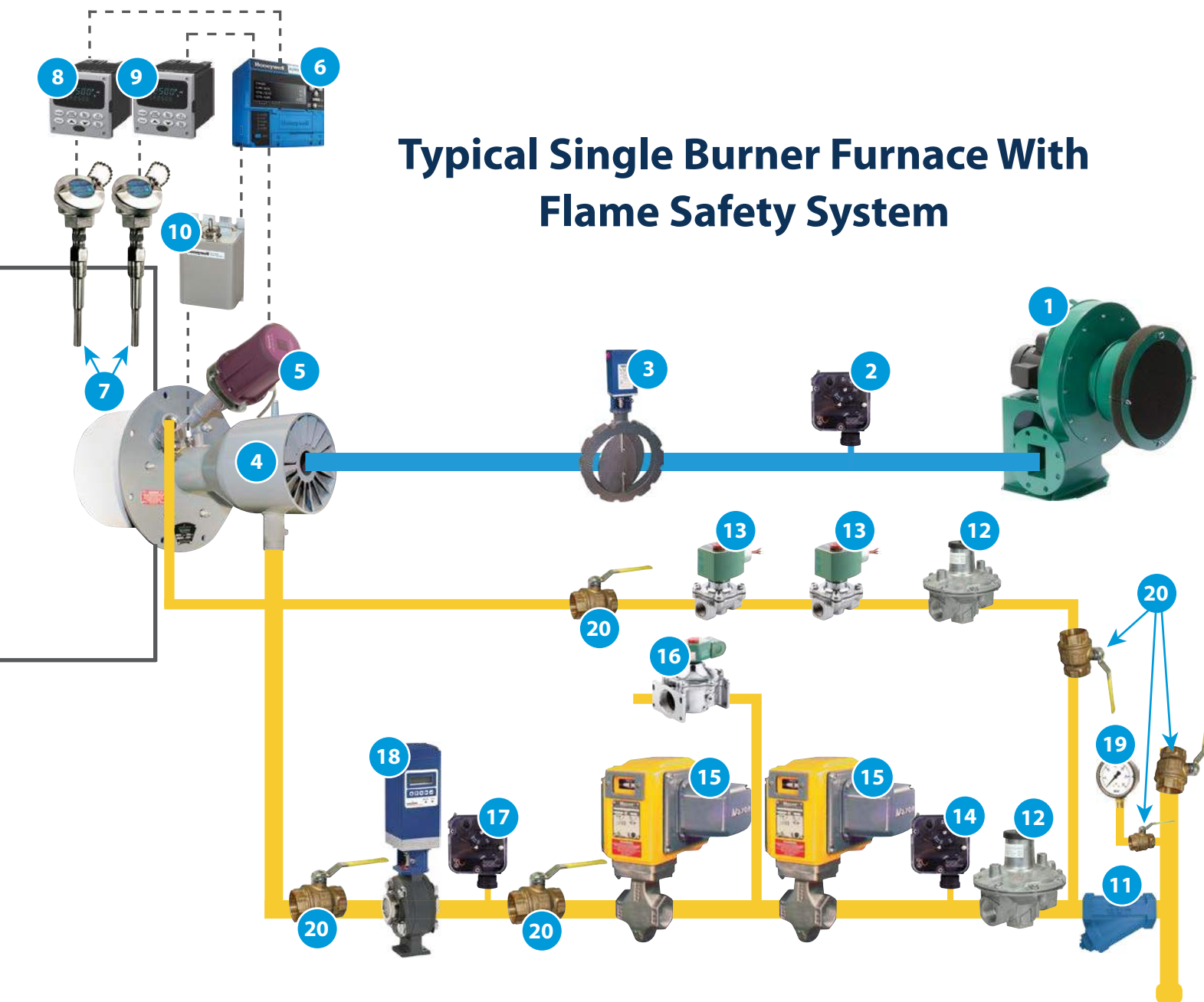

#	Component	See Page
1.	Combustion air blower	40
2.	Combustion air pressure switch	37
3.	Air control valve	27
4.	Burner	38-39
5.	Flame detector	10, 11, 13, 14, 20, 21, 22
6.	Flame safeguard control	6-9, 12, 14-19, 22, 23
7.	Thermocouple assembly	43
8.	Temperature controller	43
9.	Temperature limit control.....	43
10.	Ignition transformer	42

#	Component	See Page
11.	Y-strainer	44
12.	Gas pressure regulator	44
13.	Pilot solenoid valve	32
14.	Low gas pressure switch	37
15.	Safety shutoff valve	29-34
16.	Vent valve	33
17.	High gas pressure switch	37
18.	Gas control valve	27
19.	Pressure gauge	42
20.	Isolation valve	44

Honeywell SLATE Integrated Combustion Management System



Honeywell SLATE is an integrated combustion management system that combines configurable flame safety and programmable logic into a single platform.

Honeywell SLATE was designed for single and multi-burner use in make-up air, process heating, burner control, automotive paint booths, kilns, ovens, and commercial and industrial boilers applications.

- Integrated flame safety and programmable logic control system in a fully configurable DIN-rail mountable platform
- Buy only the modules you need and choose how to use them with simple wiring commands
- Plain-language interface for easier setup and service
- Flexible programming tools help you develop and implement differentiating applications more quickly
- Reduce engineering time with simplified wiring, installation, and programming
- Temperature range: -20° to 150° F
- Provides 24 to 240 VAC flame safeguard
- Dual fuel capability
- CE, CSA, UL, FM approved, SIL 3 capable



Get full specifications and learn more about the SLATE combustion management system at bit.ly/honeywell-slate



Base Module

The SLATE Base Module provides communication and user-programmable logic, and non-safety digital and analog I/O modules provide inputs and outputs for that logic. The programmable logic can be used to create any non-safety features needed by the equipment that the SLATE system is controlling.

- Modbus/TCP, BACnet MSTP or IP and web service communications
- Generates web-based pages for browser access to the system
- Event log storage for user lockouts, fault history, and user-requested events
- Trend logging for user-specified data

Burner Control and Flame Amplifier Modules



The Burner Control module controls light off sequencing and flame supervision for your combustion system. It can control fired gas, oil or a combination fuel for single burner applications.

The Flame Amplifier module detects the presence of flame in response to a signal from a rectifying or ultraviolet flame detector. There are four different types of amplifier modules you can choose from: UV Shutter-Check, UV Ampli-Check, UV/Visible Ampli-Check, and Rectification.

- Provides integrated burner control for automatically fired gas and oil or combination fuel single burner applications
- Amplifier modules provide display of flame signal strength

Touchscreen Display



The SLATE 7" or 10" color touchscreen is web enabled, so you can access the SLATE Web Editor tool and customize each module in the SLATE system to meet your application's unique needs. The touchscreen can be used for viewing system status and for creating or modifying system configurations.

- Display screens are web pages served from SLATE Base Module
- Standard display screens for burner control, fuel/air ratio, limit, and base modules



Fuel Air Ratio Control Module

The Fuel Air Ratio module controls the balance between the amount of air and fuel in the combustion system. This module can control up to three different types of fuel while also controlling the system's actuators. The Fuel Air Ratio module receives feedback from the actuators using Modbus communications.

- Controls relationship between fuel, airflow, and flue gas recirculation on a power burner
- Air-fuel ratio control for up to four actuators
- Drives two variable frequency drives
- RS-485 communications to SLATE actuators for control and feedback

Digital I/O Module



- Automatically adapts to 24 VDC or 24 to 240 VAC
- Configurable input or relay output format
- Upto 14 opto inputs
- Upto 6 relay outputs

Analog I/O Module



- 4 analog cells per module
- Configurable analog module that supports voltage, current, PWM, tachometer, RTD, NTC, and thermocouples



Annunciator Module



The annunciator module monitors the status of the interlock string (the built-in safeties). It can detect when and where there is a problem in the SLATE system, and send an alert stating what the problem is. This alert can be found on the Honeywell touchscreen display or the Honeywell Generic Webpage.

- Monitors the status of a series of string limit, control and interlocks and alerts the system to the problem area

Limit Control Module



The Limit Control module controls the safety limits for both high and low pressure and temperature. If the pressure or temperature goes above or below these limits the system will send out an alert or the entire system will shutoff, based on how you choose to program the system.

- 12 limit blocks, each monitoring any sensor or pair of sensors
- One limit module for multiple burner controls
- Four sensors available for Limit Block use (two sets of redundant safety inputs)
- Redundant limit relay output

Quarter-Turn Actuator



The SLATE low torque quarter-turn actuators offer highly repeatable position accuracy and are compatible with multiple valves.

- Available in 50 and 150 in/lb models
- 450 or 900 positions over 90deg span
- Field-reversible clockwise or counterclockwise rotation operation
- Reports internal temperature, valve status, health diagnostics, and error codes
- Closed loop position control via Modbus RS-485

Model Selection Guide

The SLATE combustion system requires a standard base unit, flame amplifier, burner control module and a touchscreen display. Additional modules include: fuel air ratio control, limit control, annunciator, digital I/O, and analog I/O.

Description		Catalog Number	Price
Required components			
Slate Base Module		☐ R8001A1001	\$939.17
Burner Control (includes valve proving)		☐ R8001B2001	536.67
Color Display	10" touch screen LCD display	☐ R8001K1010	1516.67
	7" touch screen LCD display	R8001K5001	1070.65
Flame Amplifier Module	Rectification	☐ R8001V1031	335.42
	UV ampli-check	☐ R8001S1071	402.50
	UV shutter-check	R8001S1051	536.67
Modules to add more capability			
I/O Module	Analog I/O module	☐ R8001U3001	805.00
	Digital I/O module	☐ R8001D4001	536.67
Fuel Air Ratio Control Module		R8001C6001	670.83
Annunciator Module		☐ R8001N7001	536.67
Limit Control Module		☐ R8001L8001	536.67
Sub-base for DIN-rail mounting. Required for each module except base module.		☐ R8001S9001	67.08
Actuator*	50 In/Lb actuator NEMA 4 enclosure	R8001M4050	1081.50
	150 In/Lb actuator NEMA 4 enclosure	R8001M4150	1254.54

* Slate is also compatible with Smartlink DS actuators (see page 27)



Sub-Base

The sub-base lets you mount the SLATE system in a panel via DIN rail. You'll need to order a sub-base for each module except the Base Module.

THERMAL IQ REMOTE MONITORING SOLUTION

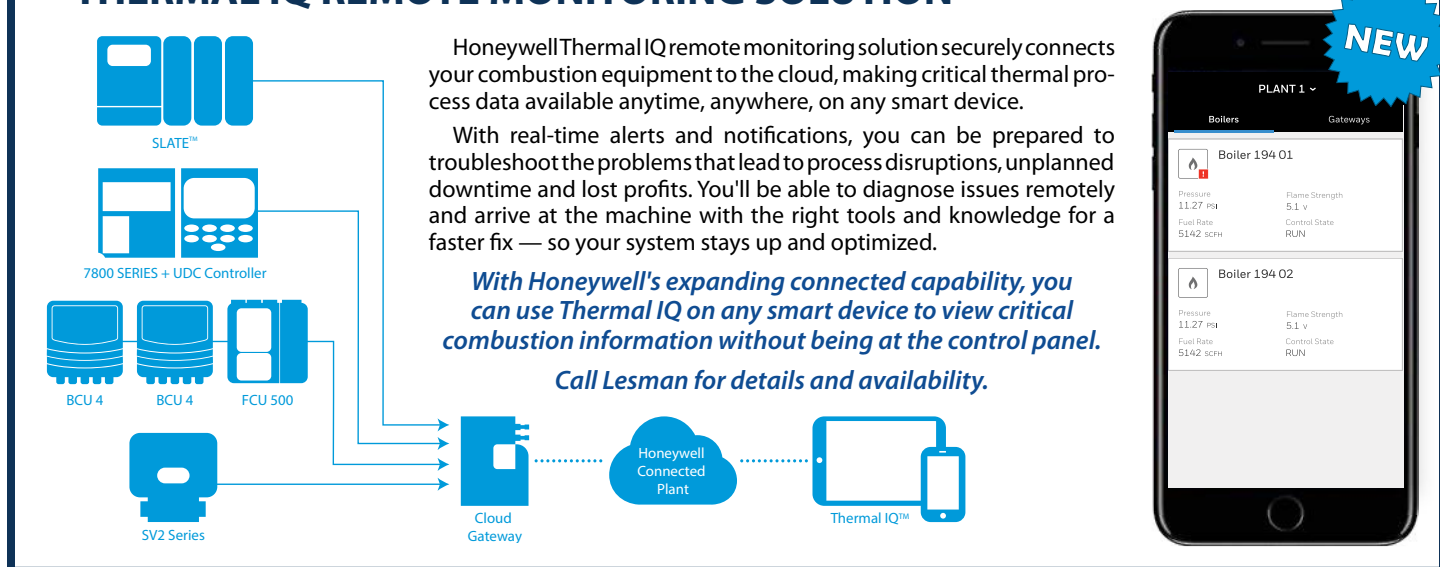

Honeywell 7800 Series Burner Controls

Model	RM7840	RM7890	RM7895	RM7898
Control Type	Programming	On-Off Primary	On-Off Primary	On-Off Primary
Added Function	Selectable Pre-Purge Timing, Air Flow Check	Units Available with Valve Proving (VPS)	Selectable Pre-Purge Timing	Selectable Pre-Purge Timing, Shutter Drive, Programmable Post-Purge, Valve Proving

Honeywell 7800 enhanced burner controls

Enhanced 7800 models offer several added features at a lower price than the core 7800 burner control series.

- Expanded cycle counter
- Standard run/test switch
- Jumper for intermittent or interrupted pilot
- Valve proving functionality, and
- Pre-ignition interlock (for proof of closure)

Look for a * for enhanced model part numbers.

Enhanced > Legacy	RM7890 B1048	RM7897 A1002	RM7897 C1000	RM7898 A1000	RM7840 L1075	RM7800 L1087
RM7890A1015	•					
RM7890A1056	•					
RM7890B1014	•					
RM7895A1014		•		•		
RM7895C1012		•	•	•		
RM7897A1002				•		
RM7897C1000				•		
RM7840L1018					•	•

RM7840 Programming Control Unit for Forced-Air Burners



Programming control with valve proving for automatically fired gas-, oil-, coal-, or combination fuel single-burner applications.

- Interrupted pilot type
- Airflow check feature
- Valve proving feature tests valve seat integrity to detect a leak greater than 0.1% of burner input capacity
- Five LEDs provide sequence information. Power LED blinks fault code on Lockout.
- CSA, FM, and UL approved



Required components: Q7800 universal wiring subbase, R78 series flame signal amplifier, ST7800A plug-in purge timer cards, S7800A1142 keyboard display module for advanced diagnostics, and to set up valve proving

Model Selection Guide

Flame Establishing Period		Interlocks	Catalog Number	Price
Pilot	Main			
4 or 10 seconds	10 or 15 seconds	Lockout, low-fire and high-fire (LHL-LF&HF)	RM7840L1075*	\$3200.72
4 or 10 seconds	10 or 15 seconds	Lockout	RM7840L1018	3230.99

RM7895 On-Off Primary Control Unit for Forced-Air Burners

Microprocessor-based integrated primary burner control for automatically fired gas, oil, or combination fuel single burner applications.

- On/off primary control with prepurge and airflow switch check
- Five LEDs for sequence information
- Optional local or remote annunciation of operation and fault information, remote reset capability
- Selectable relight or lockout on loss of flame

Required components: Q7800 universal wiring subbase, R78 series flame signal amplifier, ST7800 plug-in purge timer card



NORMALLY AVAILABLE FROM STOCK

Model Selection Guide

Flame Establishing Period		Pilot Type	Airflow Check	Delayed Main Valve	Interlocks	Catalog Number	Price
Pilot	Main						
4 or 10 seconds	Intermittent	Intermittent	No	No	Selectable	RM7895A1014*	\$868.77
4 or 10 seconds	Intermittent	Intermittent	Dynamic	No	Selectable	RM7895B1013	868.77
4 or 10 seconds	10 Seconds	Interrupted	Dynamic	Yes	Selectable	RM7895D1011	1091.54



RM7890 On-Off Primary Control with Valve Proving for Forced-Air Burners



Microprocessor-based integrated primary burner control for automatically fired gas, oil, coal, or combination fuel single burner applications.

NORMALLY AVAILABLE FROM STOCK

- Five LEDs for sequence information
- Valve proving feature tests valve seat integrity to detect a leak greater than 0.1% of burner input capacity
- Closed loop logic test, expanded safe-start check, internal hardware status monitoring and tamper-resistant timing and logic
- Selectable recycle/lockout on loss of flame
- UL, CSA, FM, FCC approved



Required components: Q7800 universal wiring subbase, R78 series flame signal amplifier, S7800A1142 keyboard display module (shown) for advanced diagnostics and to set up valve proving

Model Selection Guide

Flame Establishing Period		Pilot Type	Special Features	Catalog Number	Price
Pilot	Main				
4 or 10 seconds	Intermittent	Intermittent		RM7890A1015	\$651.39
4 or 10 seconds	Intermittent	Intermittent	Shutter Drive Capability	RM7890B1014	944.53
Fixed 4 or 10 seconds	Intermittent	Intermittent	Shutter Drive Capability, Blinking LED Fault Annunciation	RM7890B1030	663.95
4 or 10 seconds	Intermittent	Intermittent	Valve Proving (VPS) Check Feature, Blinking LED Fault Annunciation	RM7890A1056	661.17
4 or 10 seconds	Intermittent	Intermittent	Shutter Drive Capability, VPS Check, Blinking LED Fault Annunciation	RM7890B1048*	589.70

RM7898 On-Off Primary Control Unit with Valve Proving



Microprocessor-based integrated primary burner control for automatically fired gas, oil, or combination fuel single burner applications.

- On/off primary control, programmable post purge and valve proving feature available through keyboard display module
- Five LEDs for sequence information, power LED blinks fault code on safety shutdown
- Airflow switch check and shutter drive output
- Selectable recycle or lockout on loss of airflow or flame
- Local or remote annunciation of operation and fault information

NORMALLY AVAILABLE FROM STOCK



Required components: Q7800 universal wiring subbase, R78 series flame signal amplifier, ST7800 plug-in purge timer card, S7800A1142 keyboard display module

Model Selection Guide

Flame Establishing Period		Pilot Type	Special Features	Catalog Number	Price
Pilot	Main				
4 or 10 seconds	Intermittent or 10 seconds	Selectable	Shutter drive output, programmable post purge, valve proving	RM7898A1000*	\$734.37



Q7800A or B Wiring Subbases for RM7800 Burner Controls

Select either the panel-mount or burner-mount version of the Q7800A,B 22-terminal universal wiring subbase to mount your 7800 series relay. Both are fully compatible with all 7800 relay modules, so you can specify a wiring termination approach that meets your application requirements.



Model Selection Guide

Description	Catalog Number	Price
22 Terminal Universal Wiring Subbase		
Panel Mount	Q7800A1005	\$46.23
Burner/Wall Mount	Q7800B1003	46.23



R78 Series Flame Signal Amplifier Modules

- Dynamic Ampli-Check™ or Self-Check rectification available, with safety shutdown on amplifier or system failure
- Flame signal strength 0.0 to 5.0 VDC
- Test jacks measure amplifier signal voltage
- UL, CSA, FM approved

Solid-state flame signal amplifiers detect the presence of flame in response to a signal from a rectifying, or ultraviolet, flame detector.

Dynamic Ampli-Check™ circuitry tests flame amplifier during burner operation; 7800 series relay module locks out on safety shutdown with amplifier failure.

Dynamic Self-Check amplifiers test electronic components in the flame detection system 10 to 12 times per minute. The 7800 series relay module locks out on safety shutdown with flame detection system failure.

NORMALLY AVAILABLE FROM STOCK

Model Selection Guide

Color Code	Type	Flame Failure Response Time	Self-Checking	Compatible Flame Sensors	Catalog Number	Price Each
Rectification-Type Flame Amplifiers, Green						
Green	Rectification	3.0 Seconds	Dynamic	C7024E, F Flame Detector	R7824C1002	\$775.54
Green	Rectification	0.8 or 1.0 Second	Standard	Gas: Rectifying Flame Rods C7004/7005/7007/7008/7009, Q179	R7847A1025	309.40
Green	Rectification	2.0 or 3.0 Second	Standard	Gas: Rectifying Flame Rods C7004/7005/7007/7008/7009, Q179; Gas, Oil and Coal: Ultraviolet Flame Sensors C7012A, C	R7847A1033	309.40
Green	Rectification	0.8 or 1.0 Second	Standard	Gas: Rectifying Flame Rods C7004/7005/7007/7008/7009, Q179*	R7847A1074	309.40
Green	Rectification	2.0 or 3.0 Second	Standard	Gas: Rectifying Flame Rods C7004/7005/7007/7008/7009, Q179* Gas, Oil, and Coal: Ultraviolet Flame Sensors C012A, C	R7847A1082	309.40
Green	Rectification	0.8 or 1.0 Second	Ampli-Check	Gas: Rectifying Flame Rods C7004/7005/7007/7008/7009, Q179	R7847B1023	888.75
Green	Rectification	2.0 or 3.0 Second	Ampli-Check	Gas: Rectifying Flame Rods C7004/7005/7007/7008/7009, Q179 Gas, Oil, and Coal: Ultraviolet Flame Sensors C7012A, C	R7847B1031	888.75
Green	Rectification	0.8 or 1.0 Second	Ampli-Check	Gas: Rectifying Flame Rods C7004/7005/7007/7008/7009, Q179*	R7847B1064	888.75
Green	Rectification	2.0 or 3.0 Second	Dynamic	Gas, Oil, and Coal: Ultraviolet Flame Sensors C7012E, F	R7847C1005	673.27
Ultraviolet-Type Flame Signal Amplifier, Purple						
Purple	UV	0.8 or 1.0 Second	Standard	Gas, Oil: Minipeeper C7027A, C7035A, C7044	R7849A1015	309.40
Purple	UV	2.0 or 3.0 Second	Standard	Gas, Oil: Minipeeper C7027A, C7035A, C7044	R7849A1023	309.40
Purple	UV	0.8 or 1.0 Second	Ampli-Check	Gas, Oil: Minipeeper C7027A, C7035A, C7044	R7849B1013	483.10
Purple	UV	2.0 or 3.0 Second	Ampli-Check	Gas, Oil: Minipeeper C7027A, C7035A, C7044	R7849B1021	483.10
Purple	UV	2.0 or 3.0 Second	Dynamic	Gas, Oil, and Coal: Ultraviolet Flame Sensor C7061	R7861A1026	814.78
Purple	UV	0.8 or 1.0 Second	Dynamic	Gas, Oil, and Coal: Ultraviolet Flame Sensor C7061	R7861A1034	814.78

* Leadwire runs greater than 50 ft.

ST7800A Plug-In Purge Timer Cards



Purge timers let you purge unburned fuels from the combustion chamber. The plug-in cards install easily into the 7800 series relay module. They are available in 15 timing ranges from 2 seconds to 30 minutes.

- CSA, FM approved, UL recognized

NORMALLY AVAILABLE FROM STOCK



Model Selection Guide

Description	Catalog Number	Price	Description	Catalog Number	Price	Description	Catalog Number	Price
2-Second Pre-Purge	ST7800A1005	\$86.63	30-Second Pre-Purge	ST7800A1039	\$86.63	2.5-Minute Pre-Purge	ST7800A1070	\$86.63
7-Second Pre-Purge	ST7800A1013	86.63	60-Second Pre-Purge	ST7800A1054	86.63	4-Minute Pre-Purge	ST7800A1088	86.63
10-Second Pre-Purge	ST7800A1021	86.63	1.5-Minute Pre-Purge	ST7800A1062	86.63	6-Minute Pre-Purge	ST7800A1096	86.63

Don't see the timer card you need? Call Lesman.



Burner Control Plug-In Accessories



2-Line: S7800A1142

S7800A Universal Keyboard Display Modules

Provides current status of burner sequence, timing, hold, and lockout information plus selective or preemptive messages. Required for programming Valve Proving and Post Purge features on 7800 series relay modules.

- First-out annunciation and system diagnostics provided in 2-line or 4-line display
- The new 4-line keyboard display shows fault code, enhanced diagnostics and troubleshooting, and lets you set the language to English, Spanish or French
- Provides burner control data, remote reset, and report generation
- Local or remote operation, fault information
- UL listed, CSA certified, FM approved, and FCC rated



Model Selection Guide

Description	Catalog Number	Price
2 Line Universal Keyboard Display; Temperature rating: -40° to 140° F	☐ S7800A1142	\$676.72
4-Line Universal Keyboard Display; Temperature rating: 0° to 140° F	S7800A2142	846.22



4-Line: S7800A2142



Look for the ☐ for in stock models normally available to ship within 24 hours.

S7810 and S7820 Modules

Add communication and control functionality to your 7800 series relay modules

- All install directly on front of 7800 relay modules
- Communications interface for PCs or Modbus RTU networks
- Remote control and reset functions
- Support for remote mounted keyboard display module



Model Selection Guide

Description	Catalog Number	Price
Remote Reset Module: Provides remote reset by pushbutton at up to 1000 feet away	☐ S7820A1007	\$296.19
Data ControlBus Module: Remote mounting for Keyboard Display Module, remote reset, and communication interface to PC	S7810A1009	362.89
Modbus Module: Remote mounting for Keyboard Display Module, remote reset and control, and communicates to Modbus RTU network as slave device	S7810M1003	279.73

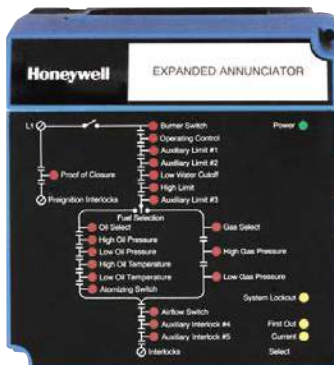

S7830A1005 First-Out Expanded Annunciator Panel

Monitors the status of a series string of limit, control, and interlock contacts. It enhances fault and status messages of the 7800 series burner control.

- 26 LEDs — 22 LEDs to annunciate limits and interlocks, 4 LEDs to annunciate power, current status, first-out status, and system lockout
- Enhances keyboard display module sequence hold and lockout messages
- Connects to 7800 series relay module via RS485
- UL listed, CSA, FM approved



Model Selection Guide

Description	Catalog Number	Price
First-Out Expanded Annunciator	S7830A1005	\$1187.03
Connector to Keyboard Display	203541	65.52



Model	C7008	C7012 Purple Peeper®	C7027 Minipeeper®	C7035 Minipeeper®	C7061 Purple Peeper®	C7061M
Detector Type	Flame Rod	Rectification Ultraviolet	Ultraviolet	Ultraviolet	Ultraviolet	Ultraviolet
Burner Type	Gas-Fired	Coal, Gas, or Oil-Fired	Coal, Gas, or Oil-Fired	Coal, Gas, or Oil-Fired	Gas or Oil-Fired	Gas or Oil-Fired
Unique Feature	100% Fail-Safe Operation	Dynamic Self-Check, Shutter	1/2" Sight Pipe Mount	1" Sight Pipe Mount	Dynamic Self-Check	Dynamic Self-Check
Flame Amplifier	R7847A, B	R7847C	R7849A, B	R7849A,B	R7861	R7861

C7008 Rectification Flame Rods

Kantal A-1 flame rod with sparkplug-type rod holder, threaded base, and snap-on cover.

100% fail-safe flame detection. For gas-fired systems and intermittent pilots only. Use with Honeywell flame safeguard controls that require rectification-type flame detectors. Can be used with or without cover and cut to desired length. Includes flame rod holder and Rajah electrical connector.

Approvals: UL, CSA, FM.



Model Selection Guide

Flame Rod Length	Holder Dimensions		Electrical Connection	Catalog Number	Price
	Length	Diameter			
12"	3-3/4"	7/8"	1/4" NPT Male	C7008A1174	\$239.33
24"	3-3/4"	7/8"	1/4" NPT Male	C7008A1182	390.12

C7027 and C7035 Minipeeper® Ultraviolet Flame Detectors

Compact UV flame detectors for use on coal-, gas-, oil-fired or combination burners. Can be used with either intermittent or interrupted pilots. Compatible with R7849 solid-state UV flame amplifiers on Honeywell RM7800 series relay modules and controls.

Compact size allows for blast-tube mounting. Seals against pressures up to 5 psi when correctly installed. Wire in parallel for difficult sighting applications.

NORMALLY AVAILABLE FROM STOCK



C7027 Specifications

Mounting: 1/2" sight pipe with integral collar or 1/2" NPT threaded spud connector.

Dimensions: 1-1/8" diameter (with mounting nut), 3-7/8" length, 8" lead.

Electrical Connections: Two NEC Class 1 leadwires

Approvals: UL, CSA, FM.



C7035 Specifications

Mounting: 1" sight pipe with integral collar

Dimensions: 1-1/2" diam. (with collar), 4-1/8" length, 72" leads

Approvals: UL, CSA, FM.



Model Selection Guide

Ambient Temp. Range	Side Pipe Mounting	Catalog Number	Price
-40° to 215°F	Integral nut	C7027A1031	\$223.42
-40° to 215°F	Integral nut*	C7027A1072	223.42
0° to 215°F	Integral nut	C7027A1023	201.52
0° to 215°F	Integral nut*	C7027A1049	201.52
0° to 215°F	Integral nut**	C7027A1080	250.48

Model Selection Guide

Description	Catalog Number	Price
0° to 215° F temperature range, 6' lead	C7035A1023	\$443.36
-40° to 215° F temperature range, 6' lead	C7035A1031	465.91
Replacement UV sensing tube for C7035	129464M	418.42

* 1/2" NPT threaded spud connector

** Includes 136733 heat block and 390427B bushing



C7012 Purple Peeper® Solid-State UV Flame Detectors

120 VAC Solid-state UV flame detector with dynamic self-check, for coal-, gas-, or oil-fired burners. Can be used with intermittent or interrupted pilots. Compatible with R7847C UV flame amplifiers on Honeywell RM7800 series relay modules.

Mounts horizontally, vertically, or at any angle in between. Provides quick electrical hookup with threaded conduit fitting and color-coded leadwires. Reduces nuisance shutdowns by wiring two in parallel.

Mounting: Mounting flange with NPT internal threads for attaching to sight pipe

Approvals: UL, CSA, FM.

NORMALLY AVAILABLE FROM STOCK

Model Selection Guide

Mounting Size	Ambient Temp. Range	Shutter	Catalog Number	Price
<i>Dynamic Self-Checking Ultraviolet Detector</i>				
3/4" NPT	25° to 135°F	No	C7012A1145	\$2362.58
3/4" NPT	-20° to 125°F	Yes	C7012E1104	4886.87
1" NPT	-20° to 125°F	Yes	C7012F1052*	9462.06

* Explosion-proof housing

Looking to replace your old C7012 Purple Peeper? Consider the C7061 — a newer, more cost-effective option with a stronger flame signal. See below.



C7061 Purple Peeper® Solid-State UV Flame Detectors

Ultraviolet flame detector with dynamic self-check for gas-, or oil-fired burners. Can be used with intermittent or interrupted pilots. Compatible with R7861 dynamic self-check UV flame amplifiers on Honeywell RM7800 series relay modules.

Mounts horizontally, vertically, or at any angle in between. Reduces nuisance shutdowns by wiring two in parallel. Field-replaceable UV sensing tube and quartz viewing window.

Mounting: Mounting flange with 3/4" NPT internal threads

Dimensions: 5-1/4" diam. (with flange), 7-7/32" long, 96" leads

Approvals: UL, CSA, FM.

NORMALLY AVAILABLE FROM STOCK

Model Selection Guide

Description	Catalog Number	Price
120 VAC, 3/4" NPT	C7061A1012	\$1900.13
UV Sensing Tube	129464N	465.57

* With Brad Harrison 41310 connector



C7061M Miniature Dynamic Self-Check UV Flame Detectors

Dynamic self-checking flame detector used with R7861 dynamic self-check amplifiers for sensing the ultraviolet radiation generated by the combustion of gas, oil, or other fuels.

Mounts -45° to 90° in vertical direction. Reduces nuisance shutdowns by wiring two in parallel. Field-replaceable UV sensing tube and quartz viewing window.

Mounting: Threaded collar internal threads for attaching to a 1" sight pipe

Enclosure: NEMA 4

Model Selection Guide

Description	Catalog Number	Price
120 VAC, 1" NPT, with 8-foot color-coded leadwires	C7061M1008	\$2106.87
120 VAC, 1" NPT, NEMA 4 with Brad Harrison 41310 connector	C7061M1016	2140.89



Industrial Flame Monitoring for Continuous Burners

- Flame safeguard controls with standard 4-20mA flame signal output
- Flame and self-check relays
- Wide spectral response for hard-to-site applications
- Adjustable Flame On/Flame Off points
- Models for one, two, or three viewing heads, with independent configuration for each sensor
- Multiple flicker frequency settings prevent flame-out
- Compact UV and IR detectors ideal for pilot monitoring
- Viewing head temperature indication
- Electronic shutter for viewing head self-check
- Hazardous location viewing head models: Class I, Div 2, Groups A-D, T5 and T4A

**Multiple burners? Multiple fuels?
Changing fuels? Here's the solution!**

Honeywell's flame monitoring systems are ideal for applications in petroleum, petrochemical, pulp, paper, and metals processing industries. Their ability to discriminate in the toughest environments tailors them for industrial process, black liquor recovery, cogeneration or grate-fired builders, cement or lime kilns, Claus (H2S) reactors, thermal oxidizers, and gas turbines.

These industrial flame monitoring systems are uniquely suited for multiple burner applications, exotic fuels, hostile environments and burnertypes including combination, low NOx, opposed fired, hydrogen, duct, and register burners.

Remote Configuration, Monitoring, and Diagnostics

You can easily interface multiple signal processors through FlameTools software for remote configuration, monitoring and diagnostics. The user-friendly graphical interface provides intuitive configuration options for settings and outputs. PC software provides access to:

- Flame strength in numeric, graphic, or spreadsheet format
- Simultaneous display of multiple devices and channels
- Configuration control with easy-to-use sliders
- Data logging, with the ability to save process details to spreadsheet
- Filter wizard that automatically saves and compares flame readings for all filter settings
- Ability to save configuration of connected devices to a spreadsheet
- Automatic device detection for serial ports

Learn more about combustion controls and flame safety with our free webinar recordings at Lesman.com/train/



700 Signal Processor for Single Burner Applications

One channel signal processor with DIN-rail mounting, plug-in terminals, two-digit numeric display, keypad, and status LEDs. NEMA 1 enclosure.

Outputs: 0/4-20 mA scalable, two SPDT flame relays, one SPDT self-check relay, power detectors

Programmed via: Keypad

Processor Power: 85-265 VAC 50/60 Hz or 22-26 VDC

Ambient Temperature Range: 32° to 140°F

Approvals: FM, CSA

Compatible Viewing Heads: One S700 or S800



Model Selection Guide

Description	Catalog Number	Price
Single Burner Signal Processor, AC	700ACSP	\$1443.52
Single Burner Signal Processor, DC	700DCSP	1221.89



P522 Signal Processor for Multiburner Applications

Two-channel signal processor with mounting base, plug-in terminals, toggle, four-digit alphanumeric display, keypad and status LEDs. NEMA 1 enclosure.

Outputs: 0/4-20 mA scalable, two SPDT flame relays, one SPDT self-check relay, power detectors

Programmed via: Keypad or FlameTools software

Processor Power: 85-265 VAC 50/60 Hz or 22-26 VDC

Ambient Temperature Range: 32° to 122°F

Approvals: FM, CSA

Compatible Viewing Heads: Two S55xBE models



Model Selection Guide

Description	Catalog Number	Price
Multiburner Signal Processor, AC	P522AC	\$3645.97
Multiburner Signal Processor, DC	P522DC	3645.97



P531 Signal Processors for Multiburner Applications

Three-channel signal processor with mounting base, plug-in terminals, and status LEDs. Compatible with P532UI detachable programmer/keypad. NEMA 1 enclosure.

Outputs: 0/4-20 mA scalable, 24 VDC@ 50 mA aux out, six SPDT flame relay, one SPDT self-check relay, three normally open alarm relays, power detectors

Programmed via: Detachable P532U1 program interface or FlameTools software

Processor Power: 85-265 VAC 50/60 Hz or 22-26 VDC

Ambient Temperature Range: FM: -40° to 140°F;
CSA: 32° to 125°F

Approvals: FM, CSA

Compatible Viewing Heads: Two S55xBE and one S700 or S800



Model Selection Guide

Description	Catalog Number	Price
Multiburner Signal Processor, AC	P531AC	\$3537.35
Multiburner Signal Processor, DC	P531DC	3016.71



P532 Signal Processors for Multiburner Applications

Three-channel signal processor with mounting base, plug-in terminals, three tri-color alphanumeric scrolling displays, keypad, and status LEDs. NEMA 1 enclosure.

Outputs: 0/4-20 mA scalable, 24 VDC@ 50 mA aux out, six SPDT flame relay, one SPDT self-check relay, three normally open alarm relays, power detectors

Programmed via: Keypad or FlameTools software

Processor Power: 85-265 VAC 50/60 Hz or 22-26 VDC

Ambient Temperature Range: FM: -40° to 140°F;
CSA: 32° to 125°F

Approvals: FM, CSA

Compatible Viewing Heads: Two S55xBE and one S700 or S800



Model Selection Guide

Description	Catalog Number	Price
Multiburner Signal Processor, AC	P532AC	\$5095.20
Multiburner Signal Processor, DC	P532DC	4805.98



S700/S800 Viewing Heads

Viewing head with quick disconnect plug and 15-ft cable, 1-9 gain selection

Enclosure: IP67, NEMA 4/4X with tightened connector and UV cable protection

Approvals: FM, CSA Class 1, Div 2, Groups A-D, T4A

Ambient Temperature Range: -40° to 185°F

Compatible Signal Processors: P531 and P532 multiburner processors, 700 series single burner processors



Model Selection Guide

Description	Catalog Number	Price
<i>Aluminum housing over center latches</i>		
Infrared Viewing Head	S702	\$1878.63
Ultraviolet Viewing Head	S706	1812.96
<i>Stainless steel housing with friction twist lock</i>		
Infrared Viewing Head	S802	\$1701.95
Ultraviolet Viewing Head	S806	1851.35
15' Cable with LED, Braided Shield	ASY782	651.16



S55xBE Viewing Heads with Digital Displays

Viewing head with digital display(s), quick disconnect plug, IR high pass filter and 0-699 gain selections, 0-99 UV gain selection.

Enclosure: IP67, NEMA 4X

Approvals: CSA: Class 1, Div 2, Groups A-D, T5; FM

Ambient Temperature Range: -40° to 122°F

Color Code: UV and IR: White; IR: Red; UV: Blue

Compatible Signal Processors: P522, P531, and P532 multiburner processors



Model Selection Guide

Description	Catalog Number	Price
Ultraviolet/Infrared Viewing Head	S550BE	\$4308.01
Infrared Viewing Head	S552BE	3367.88
Ultraviolet Viewing Head	S556BE	3894.39
Cable with Braided Shield (per Ft)	C328	9.91

Honeywell



U2S All-in-One Viewing Head and Signal Processor

All-in-one integrated signal processor and viewing head system for single or multi-burner, multi-fuel and difficult flame detection applications where high level discrimination is required.

- Integrated signal processor and viewing head with up to three sensors (UV Tron, solid state UV, and solid state IR) — save cost on cabinets and wiring
- Independent configuration and adjustable gain settings for each sensor
- Ten selectable flicker frequency filters for solid state UV and IR sensors, depending on model
- Electronic system self-check — no mechanical shutter
- Two 2 amp outputs: one normally open flame relay and one normally open fault/self-check relay
- Modbus RS-485 for use with FLAMETOOLS-PC (248 loops) or FLAMETOOLS-HMI/U (32 loops)
- Programmable using touchscreen interface with easy-to-follow scrolling menu
- Fit for use in SIL-3 systems

Specifications

Relay Outputs: 1 normally open for flame, 1 normally open for fault/self-check and 4-20mA

Input Power: 22–26 VDC, 120 mA max.

Analog Flame Signal: 0/4-20 mA output

Ambient Temperature Range: -40° to 158°F

Enclosure: IP66

Approvals: CSA, FM

Model Selection Guide

Sensor Type	Cable Type	Cable Length	Fuel Type	Catalog Number	Price
U2S Viewing Head and DC Signal Processor					
IR/UV Tron/ UVSS	Factory Installed Pigtail Extension, FM Approved: Class I, Div 1	10ft	All	U2-1010S-PF	\$9874.89
IR/UV Tron/ UVSS		50ft	All	U2-1010S-PF-050	9911.41
IR/UV Tron/ UVSS		100ft	All	U2-1010S-PF-100	10433.06
UV Tron		10ft	Gaseous Fuels	U2-1016S-PF	7563.97
IR/UV Tron	Quick Disconnect, FM Approved: Class 1, Div 2	10ft	All	U2-1018S-PF	9314.09
IR/UV Tron/ UVSS		See Below	All	U2-1010S	7521.54
UV Tron		See Below	Gaseous Fuels	U2-1016S	5999.01
IR/UV Tron		See Below	All	U2-1018S	7162.49
Cable					
50 ft Cable Assembly with Connector [1]				ASYU2S	954.63

[1] Call for 100ft, 200ft, and 300ft cable assemblies

Honeywell

P222 Flare Stack Signal Processor and Viewing Head



One channel signal processor for UV flare stack monitoring, with mounting base, plug-in terminals, four-digit alphanumeric display, keypad, and status LEDs. Watchdog III UV flare stack viewing head with digital display, quick disconnect plug and 0-99 gain.

In many industries, EPA regulations require the monitoring of a stack's flame, or the pilot flame that ignites the gases, to avoid releasing unburned hydrocarbons into the atmosphere.

The Watchdog III system monitors pilot and flare stack activity using an ultraviolet sensor. It provides continuous burner surveillance indicating the presence or absence of a flame at the flame tip, to help comply with state and federal EPA reporting regulations.

The P222 signal processor includes two independent relays, one for early response (adjustable from 1-60 seconds) to a flame loss, and the other for time-delayed response (adjustable between the early response time and 60 minutes) for a flame-out alarm. The signal processor pairs with the S256B ultraviolet viewing head for a fully functional flare stack monitoring system.

Processor Outputs: 0/4-20 mA scalable, two SPDT early indication, one SPDT delayed indication, power detector

Programmed via: Keypad or FlameTools software

Processor Power: 85-265 VAC 50/60 Hz

Ambient Temperature Range: Processor: 32° to 140°F; Viewing Head: -40° to 140°F

Enclosure: Processor: NEMA 1; Viewing Head: IP67, NEMA 4X

Approvals: CSA Special Acceptance

Model Selection Guide

Description	Catalog No.	Price
Flare Stack Signal Processor, AC	P222	\$5081.20
Flare Stack UV Viewing Head	S256B	7047.43
Cable with Braided Shield (per Ft)	C328	9.91



Flame Monitor Series Burner Control System

Flame-Monitor Chassis

The Flame-Monitor Series provides the proper burner sequencing, ignition and flame monitoring protection on automatically ignited oil, gas and combination fuel burners. Interchangeable programmer and flame amplifier modules allow complete versatility in selecting control function.

The Flame-Monitor control uses the same wiring base as the Fireye D-Series and C-Series Controls and is directly interchangeable with most models with out rewiring.

The Flame-Monitor control can be used with ultraviolet, AUTOCHECK® infrared, photocell, flame rod or self-check ultraviolet flame scanners. Special features include remote reset, remote display, expanded annunciation of safety lockouts, programmability of safety interlock messages, and remote data communications capability.

The complete Flame-Monitor control consists of a chassis, display module, programmer, amplifier, scanner and a wiring base.

EP Programmer Module

The Fireye EP Programmer Modules provide start-up programming, safe start check, and flame monitoring supervision. They ensure open damper high fire purge interlock, proof of low fire position and fuel valve end switch safety checks.

A running interlock circuit constantly monitors the limit switches, air flow switches and fuel pressure switches throughout the programmer. EP programmer modules will de-energize all fuel valve circuits within 4 seconds following a flame failure or at the end the pilot-trail-for-ignition. Provide a Check-Run switch to stop the control in its firing sequence at any time (except MTFI) to aid in setup, start-up, and check out of the burner and its associated interlocks.

EP programmers offer the following functions: an increase of purge timing and air flow switch opened at the start of the operating cycle. EP programmers include an RJ45 style connector to interface with the ED510 display module. EP programmers store the burner cycle and on-time history, as well as lockout history (with burner cycle and burner hour time stamp).

Flame Scanners

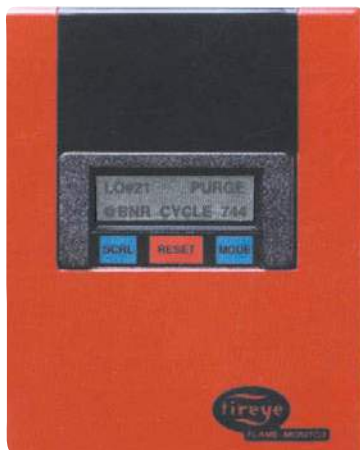
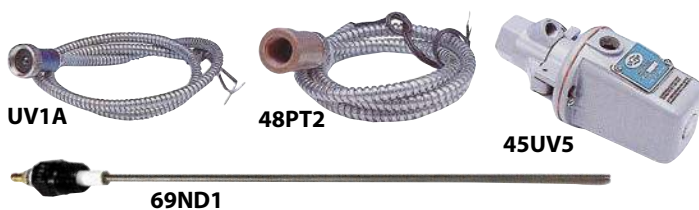

ED510 Display Module

- LCD backlit display with 2 lines of 16 characters each
- 3-key keypad provides historical data from the burner, the last 6 lockout conditions (with burner cycle and burner hour time stamp)
- Mounts directly onto front face of programmers
- Continuous display of current burner status, including first out annunciation in the event of a lockout condition
- Remote display capability using DIN-sized opening and remote mounting kit
- RJ style connector

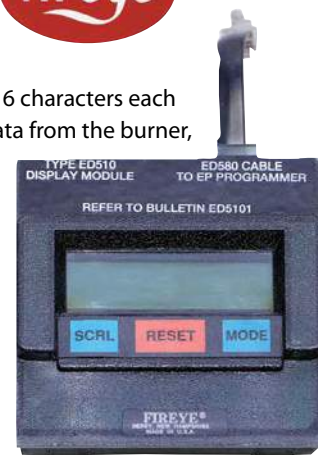

Flame Amplifier Module

Flame amplifier modules are used with the appropriate flame scanner to provide flame scanning capability. Fireye offers ultraviolet amplifiers and flame rectification amplifiers for use with flame rods, photocells and auto-check infrared amplifiers.

Self-checking ultraviolet scanners and amplifiers should be used in applications where burner firing operation is continuous or where the burner is on for long periods of time without cycling.



Model Selection Guide

A complete system includes a chassis, program module, display, flame scanner with a compatible amplifier module, and a wiring base.

Component Description	Catalog Number	Availability	Price
Chassis	120VAC Chassis with Mounting Screws and Dust Cover	E110	•••• \$1238.00
Program Module	30 Sec. Purge, 10/15 Sec. TFI, 4 Sec. FFRT, Non-Recycle Modulation	EP160	•••• 1682.00
Display	2 Line x 16 Character LCD Display with Keypad	ED510	•••• 872.00
Flame Scanner	Non Self-Checking Scanner, 3 Ft. Flexible Cable, 1/2" NPT Conn.	UV1A3	↓ 218.00
	Non Self-Checking Scanner, 6 Ft. Flexible Cable, 1/2" NPT Conn.	UV1A6	↓ 260.00
	Infrared Scanner, 8 Ft Shielded Cable with 90° Head	48PT2-9003	↓ 345.00
	Ultraviolet Self-Checking Scanner 120 VAC Shutter, 1" NPT Thread	45UV5-1009	↓ 1882.00
	12" Flame Rod for Gas Flames, 1/2" NPT Connection	69ND1-1000K4	↓ 145.00
Amplifier Module	Standard Ultraviolet Amplifier	EUV1	• 657.00
	Autocheck Infrared Amplifier	E1R1	• 976.00
	Self-Check Ultraviolet Amplifier	EUVS4	• 1106.00
	Flame Rectification Amplifier	ERT1	• 650.00
Wiring Base	Surface Mount	60-1386-2	•••• 188.00
	Panel Mount	60-1466-2	•••• 188.00

Industrial MB Series Multi-Burner Control Systems



The Fireeye Multi-Burner Monitoring System controls the start-up sequence and monitors the flame of up to 20 individual gas, oil or combination gas/oil burners connected to a common valve train. Dynamic on-board diagnostics check for faulty relays, proof of valve closure, high and low fire switch interlocks, and shortened air switch. The MB is even able to specifically identify which burner caused the initial flame failure.

Plug-in flame sensor modules that can sense UV, UV self-check or flame rod provide for easy replacement on an individual basis. Configuration and startup time is reduced through use of on-board DIP switches, which also allow sequencing and timing functions.

The MB-600S chassis directly powers pilot and main gas valves and ignition transformers. The built in blower output, purge timing and modulation control, let you add independent limits and a controller to create a complete combustion control system for furnace, oven or other multi-burner applications.

Specifications

- Number of Burners:** 20 max.
- Pilot Proving Time:** 7 seconds
- Purge Time:** 0 sec to 60 min
- Pilot Trial for Ignition:** 5, 10 or 15 seconds
- Flame Failure Response Time:** 3 (±0.5) seconds
- Valve Operation:** Simultaneous (all burners operate from one fuel train)
- Supply Voltage:** 120VAC, 50/60 Hz; **Power Consumption:** 25VA
- Temperature Rating:** -32° to 122°F (-36° to 50°C)
- Contact Ratings:** Fan Motor: 15 Amp Resistive; Others: 10 Amp Resistive



For detailed specifications on compatible flame scanners, see pages 20-21.

Model Selection Guide

Description	Catalog Number	Price
-------------	----------------	-------

Step 1: Select a Chassis for your Multiburner Control System

Each Chassis includes Motherboard, Relay Board, Logic Module, 120 VAC 50/60 Hz Power Module, 4 Auxiliary Inputs, Purge Modulation, and Valve Leak Testing

Standard Chassis, No Communications	MB-600S	\$2179.00
Chassis with RS-232 Communications	MB-632S	2343.00
Chassis with RS-485 Communications	MB-685S	2343.00

Step 2: Select a Flame Sensor Module

Plug-In Flame Sensor Module, UV/FR Plastic Case with Mounting Screws	MB-600PF	436.00
--	----------	--------

Step 3: For Systems with More than 4 Burners, Select Expansion Board Modules and Cables

Expansion Board for up to 4 Burners	MB-604E	423.00
Expansion Board for up to 8 Burners	MB-608E	785.00
6" Cable for Expansion Board	59-506-1	86.80
36" Cable for Expansion Board	59-506-3	111.00

Tip: If your system has between 4 and 8 burners, select 1 MB-604E module and a connecting cable. If your system has between 9 and 13 burners, select 1 MB-608E module and a connecting cable. For systems that have 14 to 20 burners, you can mix MB-604E and MB-608E modules to fit.

Description	Catalog Number	Price
-------------	----------------	-------

Step 4: Select Optional Remote Display and Cable

Remote Display with Keypad	MB510	552.00
6 Ft. Cable for Remote Display	59-507-6	29.10
10 Ft. Cable for Remote Display	59-507-10	43.60

Step 5: Select One Flame Scanner for Each Burner on Your System

1/2" NPT UV Scanner, 6 Ft. Cable Rated for Tray Cable – Exposed Run	UV1A6	260.00
1/2" NPT Straight UV Scanner, 4 Ft. Flex Conduit, Insulated Nylon Coupling	UV7A4	245.00
1/2" NPT UV Scanner, NEMA 4, 4 Ft. Flex Conduit, Insulated Nylon Coupling	UV7A4W	314.00
1/2" NPT 90° UV Scanner, 6 Ft Shielded Cable	UV7R4	192.00
1" NPT Self-Check Scanner	UV7SC	1267.00
10 Ft Cable for UV7SC Self-Check Scanner	59-504-010	198.00
Scanner Support, Max Temp 200°F	36-935	47.00
Magnifying Lens Assembly (with insulated coupling)	46-185	120.00
Magnifying Lens	46-186	127.00
Non-Magnifying Lens	46-187	37.90
1/2" NPT Insulated Nylon Coupling	35-319	59.70



Fireye SB Series Modular Single Burner Management System



- For gas, oil or combination gas/oil burners
- Three control modes available: Purge, no purge, and modulation
- Test mode for pilot flame adjustment and turndown tests
- Compatible with flame rod (flame rectification), ultraviolet (UV) scanners, and self-checking UV scanners for continuous operation
- Optional remote LCD unit with reset button displays alphanumeric messages
- Tested to EN298, UL listed, FM approved
- Direct drop-in replacement for retired Eclipse VeriFlame burner management system, uses the same wiring subbase

Fireye SB Series flame safeguard control is a compact, digital, modular burner management system that provides automatic ignition and continuous flame monitoring for commercial sizes of heating and process equipment firing any type of fuel. The control unit includes all the necessary digital logic and analog measuring circuitry to control the sequence and monitor the flame of single gas, oil or combination gas/oil burners.

LED indicators on the front panel provide current operating status of the burner system, including lockout alarm. A test jack recessed into the front cover provides real-time reading of the connected flame sensor. It is also used to connect to a remote alphanumeric display. A push button provides reset from lockout condition and places the controller in a check condition for pilot turn down tests.

Model Selection Guide

Model	Amplifier Type	Selectable Trial for Ignition Timing	Retired Eclipse VeriFlame Model Number	Catalog Number	Price
Purge	Ultraviolet (UV)	5 or 10 Sec	VF560222AA	SB560222AA	\$875.00
		10 or 15 Sec	VF560522AA	SB560522AA	875.00
	Flame Rectification (FR)	5 or 10 Sec	VF560223AA	SB560223AA	875.00
		10 or 15 Sec	VF560523AA	SB560523AA	875.00
No Purge	Ultraviolet	5 or 10 Sec	VF560232AA	SB560232AA	749.00
		10 or 15 Sec	VF560532AA	SB560532AA	749.00
	Flame Rectification	5 or 10 Sec	VF560233AA	SB560233AA	749.00
		10 or 15 Sec	VF560533AA	SB560533AA	749.00
Modulation	Ultraviolet	5 or 10 Sec	VF560242AA	SB560242AA	1255.00
		Required modulation wiring sub-base for use with SB560242AA		49602-40	SB49602-40
Accessories	Discrete ultraviolet flame scanner, straight design		49600-90	UV7A4	245.00
	Discrete ultraviolet flame scanner, 90° right-angle design		49600-91	UV7R4	192.00
	Discrete ultraviolet flame scanner, self-check		49602-91	UV7SC	1267.00
	10' cable required for UV self-check flame scanner		49602-91-7	59-504-010	198.00
	Flame rod, 12-inch with 1/2-Inch NPT connection			69ND1-1000K4	145.00

For detailed specs on compact flame scanners, see page 21.

Fireye AC6 Programmable Rotary Actuator



- Ideal for heating applications where a maximum output from a temperature controller drives a butterfly valve to its maximum flow position
- 0–90° clockwise or counterclockwise shaft rotation with 1° minimum step

- Seven-segment LED position indicator
- Torque 20 to 35 lb-in (2.3 to 3.9 N-m)
- Analog and digital inputs
- NEMA 4 construction

Model Selection Guide

Stroke	Connection	Upgrade From		Catalog Number	Price
		Eclipse PRA	Fireye FPRA		
<i>Programmable Rotary Actuator, 120 VAC Power, Upright Display, Wiring Connections at the Bottom [1]</i>					
90°	PG II Liquidtight Flexible Cord Connector	PRA6A1AA	FRA6A1AA	AC6A1AA	\$1384.00
90°	3/8" Straight Liquidtight Conduit Connector	PRA6A1BA	FRA6A1BA	AC6A1BA	1455.00
90°	1/2" NPTF Adapter	PRA6A1CA	FPRA6A1CA	AC6A1CA	1429.00
75°	PG II Liquidtight Flexible Cord Connector	PRA6A1AD	FRA6A1AD	AC6A1AD	1384.00
75°	3/8" Straight Liquidtight Conduit Connector	PRA6A1BD	FRA6A1BD	AC6A1BD	1455.00
75°	1/2" NPTF Adapter	PRA6A1CD	FPRA6A1CD	AC6A1CD	1429.00

[1] Replace 1 in the catalog number with the following: 2 for 180° Inverted Display, Wiring Connections at the Top; 3 for Display Rotated to 90°, Wiring Connections to the Right; 4 for Display Rotated to 270°, Wiring Connections to the Left. Alternate display positions may affect shipping times.

Available to Ship in 5 Business Days or Less from Factory Stock





Microm Series MEC120 Flame Safeguard Control System

Fireeye's MicroM series flame safeguard control is a compact, microprocessor based, modular burner management system designed to provide automatic ignition and continuous flame monitoring for commercial sizes of heating and process equipment firing any type of fuel.

Unlike other flame safeguard control systems, the MicroM is not dependent on discrete components to provide timing functions. Through its microcontroller technology, MicroM includes smart diagnostic LEDs, smart reset function for multi-burner applications, and options for a local alphanumeric display output (ED510) and serial communications via Modbus or E500 communications interface.

All MicroM flame amplifiers are available with flame failure response times of 0.8 or 3.0 seconds nominal (4 seconds max), and each provides a set of test jacks with a uniform range of 0-10 VDC to measure flame signal intensity.

A complete MicroM system includes a standard chassis and wiring base, a programmer module, plug-in flame amplifier, and a flame detector. Interchangeable programmer and amplifier modules let you change control function, timing, and flame scanning as your application needs change.

Type of flame scanner and the flame failure response time (FFRT) are determined by the amplifier module.

Functions such as relight, recycle, non-recycle, two stage capability, non-recycle air flow, proof of air flow open at start, purge timing, early spark termination, pilot proving, and pilot cutoff are determined by your choice of programmer module. The programmer module's LED indicators show the current operating status of the control and, during a lockout condition, displays the fault as a coded sequence, simplifying the troubleshooting of a shutdown.

In the event of pilot ignition failure, or following a safety shutdown, the control locks out, activating an alarm circuit and displays the cause of lockout on the integrated LEDs and on the optional ED510 display. Unless otherwise specified, manual reset is required.

Modular MicroM controls incorporate a safety checking circuit that is operative on each start. If flame (real or simulated) is detected prior to a start or during purge, the fuel valves will not be energized, and the unit will lock out.

Read full specifications at bit.ly/fireeye-microm

Choose one of each of the following to build a complete MicroM system:



Chassis



Display



Programmer



Flame Amplifier



Flame Scanner

69ND1

UV1A

45UV5



Wiring Base



Communication Interface



Model Selection Guide

Description	Catalog Number	Availability	Price
Step 1: Select a 120 VAC, 50/60 Hz Chassis			
Chassis with standard plug-in daughter board	MEC120	. . .	\$425.00
Chassis with remote reset	MEC120R	. . .	511.00
Chassis with alphanumeric display	MEC120D	. . .	444.00
Chassis with remote reset and alphanumeric display	MEC120RD	. . .	522.00
Step 2: Select a programmer module			
Relight function, 10-sec PTFI	MEP100	. . .	189.00
Non-recycle on flame fail, 5-sec PTFI	MEP102	. . .	189.00
Non-recycle on flame fail, 10-sec PTFI	MEP104	. . .	189.00
Non-recycle on flame fail, lockout on air-flow open with flame present, 10-sec PTFI	MEP105	. . .	189.00
Relight operation, 12-sec purge, 10-sec PTFI, reset lockout on line power interruption	MEP106	. . .	189.00
Selectable recycle/non-recycle function, TFI timing, purge timing, post purge, prove open at start, 8-sec pilot stabilization, 10-sec main trial for ignition, run-check switch	MEP560	. . .	575.00
Step 3: Select an amplifier module			
UV amplifier, 0.8-sec FFRT	MEUV1	↓	94.40
UV amplifier, 3-sec FFRT	MEUV4	↓	93.40
UV self-check amplifier, 0.8-sec FFRT	MEUVS1	↓	201.00
UV self-check amplifier, 3-sec FFRT	MEUVS4	↓	201.00
Flame rectification, 0.8-sec FFRT	MERT1	↓	93.40
Flame rectification, 3-sec FFRT	MERT4	↓	93.40
Step 4: Select a flame scanner to match your choice of flame amplifier			
UV Non self-checking scanner, 3 ft. flexible cable, 1/2" NPT connection	UV1A3	.	218.00
UV Non self-checking scanner, 6 ft. flexible cable, 1/2" NPT connection	UV1A6	.	260.00
Ultraviolet self-checking scanner 120 VAC shutter, 1" NPT connection	45UV5-1009	.	1882.00
12" Flame rod for gas flames, 1/2" NPT connection	69ND1-1000K4	.	145.00
Step 5: Select a wiring base			
Surface mount closed wiring base	61-3060	. . .	93.70
Cabinet-mount open wiring base	61-5042	. . .	99.50
Step 6: Add optional functionality as needed			
Communication Interface Module	E500	. . .	2078.00



BurnerLogix™ Integrated Burner Management Control



Fireeye BurnerLogix is a microprocessor based burner management control system designed for proper burner sequencing, ignition, and flame monitoring protection on automatically ignited oil, gas, and combination fuel burners.

BurnerLogix learns the characteristics of the fuel being burned and sets its internal thresholds to optimize detection under all conditions. And when firing conditions change for the worse, the Adaptive IR system reacts properly and safely shuts the burner down.

BurnerLogix has a smaller footprint than its predecessors. One programmer module can solve most applications' requirements reducing spare parts inventory. Programmer modules are interchangeable, so you can choose function, timing, and flame failure response times, and easily upgrade for changing applications.

- Proof of fuel valve closure during the off cycle
- A run/check switch allows the operator to stop the program sequence in any of four different positions (Purge, PTFI, MTFI or Auto)
- Consistent flame signal read-out via display module or 4-20 mA output
- Remembers history and present position even when power is interrupted
- LED shows operating status and lockout information
- Revert to pilot can increase burner turn down
- NEMA 4 remote display
- Pigtail wiring base saves time, labor, and makes it easier to upgrade existing installations
- RS 485 Modbus communications

Choose one of each of the following to build a complete BurnerLogix system:

Model Selection Guide



Chassis

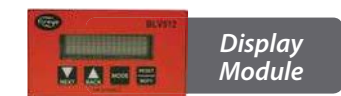

Display Module



Programmer



Wiring Base



Flame Scanner

Description	Catalog Number	Availability	Price
Step 1: Select a chassis for your burnerlogix burner control system			
Chassis	120VAC 50/60Hz; UV non self-check amplifier; UL, FM approved	YB110UV	\$1311.00
	120VAC 50/60Hz; UV self-check amplifier; UL, FM approved	YB110UVSC	1615.00
	120VAC 50/60Hz; flame rectification amplifier; UL, FM approved	YB110FR	1302.00
	120VAC 50/60Hz; direct coupled amplified for use with Phoenix or Insight Scanners; UL, FM approved	YB110DC	1526.00
Step 2: Select optional keypad/display module			
Display Module	Keypad and VFD display with cable, 2 line x 16 characters	BLV512	667.00
	Keypad and LCD display with cable, 2 line x 16 characters	BLL510	602.00
Step 3: Select programmer modules			
Programmer Module	Keypad selectable parameters, non-recycle operation, modulation, open/closed damper proving, 4 second FFRT	YP100	1159.00
	Keypad selectable parameters, non-recycle operation, modulation, open/closed damper proving, 2 second FFRT	YP102	1159.00
	Keypad selectable parameters, non-recycle operation, modulation, open/closed damper proving, revert to pilot from auto, 1 second FFRT	YP113	1159.00
	Keypad selectable parameters, non-recycle operation, modulation, open/closed damper proving, indefinite pilot hold, revert to pilot from auto, 1 second FFRT	YP118	1159.00
	Keypad selectable parameters, non-recycle operation, modulation, open damper proving, voltage on terminal 16 is indefinite	YP138	1159.00
Step 4: Select a wiring base			
Wiring Base	4' long pigtail wires, color coded and labeled; UL listed	60-2810-1	170.00
	Cabinet mount open base with terminal block; 4"W x 7"H	60-2814-1	118.00
Step 5: Select flame scanner to match your choice of chassis			
Flame Scanner	1/2" NPT Straight UV Scanner, 4 Ft. TC-ER Cable	UV1A3	218.00
	1/2" NPT Straight UV Scanner, 6 Ft. TC-ER Cable	UV7A4W	314.00
	UV Self-Check Scanner, 1" NPT, 102-264 VAC Shutter	45UV5-1009	1882.00
	12" flame rod, 1/2" NPT connection	69ND1-1000K4	145.00
	Phoenix integrated UV scanner with 8-pin electrical quick disconnect, 4 second FFRT. FM, UL, CUS approved. Requires cable assembly — see below.	85UVF4A-1QDWR	1667.00
	8-conductor cable assembly with 8-pin female connector	59-546-9 59-546-30	247.00 621.00

Comparing Fireye Integrated Flame Scanners

Fireye integrated flame scanners accurately detect the presence or absence of flame in a combustion chamber. Their advanced sensors and algorithms can discriminate the target burner from adjacent flames in the same combustion chambers, in all fuel types and burner configurations.

Use these integrated scanners to replace Fireye discrete scanner models 45UV5 (single burner applications) and 45RM4 (multi-burner applications), without the need for a separate flame amplifier or switch.

				
	Simplicity 65UV5	Phoenix 85UVF	InSight 4	InSight II 95DSS3
Detector Type	Ultraviolet	Ultraviolet	Ultraviolet or Infrared	Ultraviolet and Infrared
4-20 mA Output	One	One	One	Two
Flame Relay	SPDT (NO and NC)	SPST, Normally Open	SPST, Normally Open	Two SPDT (NO and NC)
Fault Relay	SPST, Normally Open	SPST, Normally Closed	SPST, Normally Closed	SPST, Normally Open
Enclosure	NEMA 4X/IP66	NEMA 4X/IP66	NEMA 4X/IP66	NEMA 4X/IP66
Environmental	Class I, Div 2, Groups A-D	Class I, Div 2, Class II, Div II, Class III	Class I, Div 2, Groups A-D, Class II, Div 2, Groups F-G	Class I, Div 2, Groups A-D, Class II, Div 2, Groups F-G
Approvals	FM, UL c, CE	FM, UL c/us, CE, ATEX, CENELEC	FM, CSA, UL c/us	FM, UL c/us (SIL 3), CE, ATEX
Display	Internal LED for flame signal and fault indication	LEDs and four-button interface	Two-line alphanumeric OLED display with five pushbuttons	Alphanumeric VFD display with five pushbuttons, or infrared transmitter version with wireless handheld communicator
Advanced Features			Autotune, 21 flame flicker frequencies, four selectable programmable setpoint files, adjustable sensor gain	Autotune, 21 flame flicker frequencies, four selectable programmable setpoint files, adjustable sensor gain
Diagnostics	Electromechanical self-checking shutter	Self-diagnostics and electronic self-checking	Electronic self-checking	Electronic self-checking
ON/OFF Threshold	Fixed	Automatically set	Adjustable	Independently adjustable per relay
Power	24 VDC	24 VDC	24 VDC	24 VDC



Fireye InSight II 95DSS3 Dual Sensor Flame Scanner

Fireye InSight II 95DSS3 is the first primary safety control to receive UL's SIL3 functional safety certification. InSight II scanners use advanced techniques to discriminate and integrate flame detection, amplification, safety determination, and flame switch functions into a single detection head.

Two independently adjustable flame relays can be set to operate from the ultraviolet sensor, the infrared sensor, or both. The InSight II also offers 21 choices of modulation frequency, adjustable sensor gain, adjustable flame relay ON/OFF thresholds, two 4-20 mA analog signal strength outputs, fault relay, four selectable programming files (for different fuels or firing rates), and automatic configuration capability with manual override.

The InSight II scanner can be purchased blind with a blank cover, with a two-line alphanumeric VFD display and five-button keypad, or with an infrared transmitter head that communicates wirelessly to a handheld remote communications tool.

Model Selection Guide

Description	Catalog Number	Price
Dual Ultraviolet and Infrared Flame Scanner	95DSS3-1	\$4265.00
Vacuum Fluorescent Display	95DISP-1	872.00
Wireless Display with Four LED Indicators. Requires 95WIHH-2 programmer (below).	95WIDISP-2	619.00
Wireless Programmer for 95WIDISP-2	95WIHH-2	1052.00

Description	Catalog Number	Price
Flame Scanner Mounting Flange, 1" NPT	60-2919-1	164.00
10' Cable Assembly	59-546-3	142.00
Flame Scanner Cooling Cover	60-2930-1	658.00
Windows Communication Software	FS950W-1	2112.00

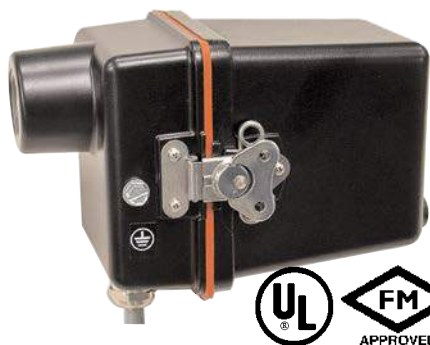

Fireye Simplicity 65UV5 Ultraviolet Scanner

The Fireye Simplicity scanner uses an ultraviolet tube-type sensor and an electromechanical self-checking shutter mechanism. It features an internal flame relay with a fixed ON/OFF threshold and a four-second flame failure response time.

The 65UV5 can be used to detect ultraviolet emissions from fossil fuel flames (natural gas, coke oven gas, propane, methane, butane, kerosene, light petroleum distillates and diesel fuels).

Model Selection Guide

Description	Catalog Number	Price
Simplicity Self-Checking Integrated Flame Scanner		
Ultraviolet Flame Scanner	65UV5-1004QD	\$2080.00
Replacement Ultraviolet Tube	4-290-1	439.00
24 VDC Power Supply	60-2685-25	493.00
Heat Insulating Jacket	97-1051	799.00



Fireye Phoenix 85UVF Ultraviolet Flame Scanner

The Phoenix 85UVF flame scanner uses a solid state ultraviolet flame detection sensor, and an internal relay with automatically set ON/OFF thresholds, eliminating the need for a remote flame amplifier or flame switch.

The scanner interface includes a pushbutton keypad and LEDs that provide continuous indication of flame signal, flame relay status, scanner status, and selected operation mode.

Model Selection Guide

Description	Catalog Number	Price
Phoenix Self-Checking Integrated Ultraviolet Flame Scanner		
UV Flame Scanner	85UVF4A-1QDWR	\$1667.00
UV Flame Scanner, ATEX and CE Approved	85UVF1-1CEX	3001.00
Mounting Flange for 85UVF1	35-318-1	74.30
10' Cable Assembly	59-546-3	142.00



Fireye InSight IV Integrated Flame Scanner

InSight Series 4 uses advanced techniques for discrimination and integrates flame detection, amplification, safety determination, and flame switch functions into a single detection head.

The scanner measures the amplitude of the modulations (the flame "flicker") that occur within the targeted flame. During the scanner setup procedure, scanner chooses the modulation frequency that yields the best flame ON/OFF discrimination.

- Independently adjustable flame relay
- 21 modulation frequency choices
- Two-line 16-character alphanumeric OLED display with a five button keypad
- Electronic self-checking (no mechanical shutter)

Model Selection Guide

Description	Catalog Number	Price
UV Flame Scanner NEMA 4X, FM, UL/c Approved	95UVS4-1	\$4547.00
10' Cable Assembly	59-547-3	185.00
24 VDC Power Supply	60-2685-25	493.00

Fireye Discrete Flame Scanners



UV1A

Ultraviolet miniature non-self-checking scanners suitable for fuel gases and #2 oil. Non-replaceable tube. Mounting collar 1/2" NPT.



48PT2

Lead sulfide scanner. Designed to detect low frequency IR signals from gas or oil flames. Mounting collar is 1/2" NPT with straight or 90° mounts. 8 ft. flexible conduit. Replaceable sensor cell.

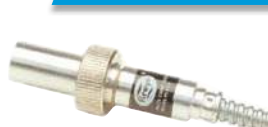

UV7A4

High sensitivity ultraviolet (UV) for monitoring gas or oil flames which cycle on and off frequently. UL listed, CSA certified, and FM approved.



UV7R4 90°

90° right angle ultraviolet flame scanner. High sensitivity ultraviolet (UV) for monitoring gas or oil flames which cycle on and off frequently. UL listed, CSA certified, and FM approved.

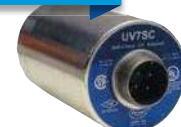

UV7SC Self-Check UV

Self-check UV7SC Used for continuous gas or oil flames. Fused silica quartz lens, alloy housing with seals, long life push-pull electromagnetically driven photo shutter. Requires cable assembly. 59-504-010.

These models require flame amplifiers



Burner Control Units	IFD 258	BCU 370	BCU 460/465	BCU 4	PFU 760/780
Operating Time	< 24 Hours	> 24 Hours	> 24 Hours	> 24 Hours	> 24 Hours
Ignition Type	Direct	Direct or Pilot Burner	Direct	Direct	Direct or Pilot Burner
Signal Line Length	75M Max	50M Max	50M Max	50M Max	100M Max
Behavior at Flame Failure	Switchable: Fault Lock-out or Restart	Programmable	Programmable	Programmable	Programmable
Gas Valve Outputs	1	2	2	3	2
Prices Start at	\$476.00	\$No Match!	\$1273.00	Available Fall 2019	\$518.00



IFD 258 Automatic Burner Control Unit

For controlling, igniting, and monitoring modulating or stage-controlled direct-ignition gas burners. Their fully electronic design allows for quick reaction to various process requirements, and makes them suitable for frequent cycling operation.

These controls let you read program status and the level of the flame signal directly from the unit. You can set the cutoff point using a potentiometer, and switch select the behavior in the event of flame failure during operation (either a restart or immediate fault lockout).

- Immediate fault lock-out or restart following flame failure
- Safety time on startup: 3, 5 or 10 sec.; During operation: 1 sec.
- Flame controls with UV sensor or ionization sensor
- UL, CSA, CE, AGA approvals

Model Selection Guide

	Trial for Ignition Timing	Catalog Number	Price
	3 seconds	84621420	\$476.00
IFD 258	5 seconds	84621440	476.00
	10 seconds	84621460	476.00



BCU 370 Burner Control Unit

For controlling, igniting, and monitoring industrial forced draught burners of unlimited capacity in intermittent or continuous operation.

- Use with UV or ionization flame sensors
- Activates blower, positions butterfly valve, monitors gas and air pressure, and checks valves with external gas pressure switch (DGmax)
- Programmable by optical interface and BCSoft PC software

Model Selection Guide

Ignition	Function	Catalog Number	Price
<i>Burner control unit for intermittent or continuous direct or pilot burner.</i>			
None	Integrated tightness control	88600708	1153.00
Electronic	DGmax pressure monitoring	88600298	918.00
Electronic	Integrated tightness control	88600299	1275.00



UVS 10D2 Ultraviolet Flame Detector

For monitoring gas burners of with or without fan, on hot-air furnaces, gas-fired boilers, industrial furnaces, and excess-gas flaring installations.

- Insensitive to sunlight, daylight, infrared radiation, and incandescent lamps
- Tube life expectancy 10,000 operating hours
- Protects against interruptions or short circuits in the flame signal line
- Rugged aluminum construction with integrated heat guard, 1/2" NPTF threaded collar and 6-foot leads



Model Selection Guide

Description	Catalog Number	Price
UVS10D2 Ultraviolet Flame Detector	84315205	\$208.00
Ultraviolet Replacement Tube	74960445	139.00



BCU 460 and BCU 465

For controlling, igniting, and monitoring directly ignited gas burners of unlimited capacity in intermittent or continuous operation.

The BCU460 has a fully electronic design that reacts quickly to various process requirements, making it suitable for frequent cycling operations. For industrial furnaces, the BCU460 takes over tasks that relate to the burner, relieving the load on the actual furnace.

- Displays program status, unit parameters, and flame signal level directly on the unit
- BCU465 has Proof of Closure switch monitoring and purge timing
- You can adjust unit parameters to meet local requirements using BCSoft software
- Optional air valve control assists furnace control for cooling, purging and capacity controls task
- Optional PROFIBUS DP interface
- Certified for SIL 3 and compliant with PL e

Model Selection Guide

Trial for Ignition Timing	Features	Catalog Number	Price
BCU 460; 2s flame failure response time			
5 seconds		88611722	\$1273.00
10 seconds		88611723	1273.00
5 seconds	Air valve control	88611724	1357.00
10 seconds	Air valve control	88611725	1357.00
BCU 465; extended air valve control; 2s flame failure response time			
5 seconds		88611726	1490.00
5 seconds	Digital input to interrupt flame rod monitoring	88611727	1615.00
5 seconds	Digital input to interrupt flame rod monitoring; Proof of Closure input	88611728	1678.00
5 seconds	Proof of Closure input	88611729	1553.00

NEW



NEXT GENERATION BCU 4

- 4-digit 7-segment display
- Parameter chip card for easy replacement
- Additional valve outputs
- Capacity control optimized for high numbers of operating cycles
- Power module with wear parts can be replaced
- Air valve control with semi-conductor output
- High temperature operation with menox® functionality
- Valve proving system
- Failsafe bus communication within the protective system (FCU 500 – BCU 4xx)
- Optional inputs

Available Fall 2019. Call Lesman at 800-953-7626 for pricing and delivery.

PFU 760/780 Burner Control Units

The PFU 760/780 burner control units ignite and monitor gas burners for intermittent or continuous operation. Their fully electronic design allows for quick reaction to various process requirements, and makes them suitable for frequent cycling operation.

The **PFU 760** can be used for modulating or stage-controlled directly-ignited industrial burners of unlimited capacity. On industrial furnaces, PFU controls reduce the load on the central furnace control by taking over tasks that only relate to the burner.

The **PFU 780** can be used for pilot-burner-ignited industrial burners of unlimited capacity. Pilot and main burners are controlled and monitored independently, reducing the main burner start-up time.

The burner control unit is for atmospheric burners and burners with mechanical combustion air supply where the fan is controlled by separate logic.

The PFU 760L and 780L are equipped with an air valve control to assist the furnace control for cooling, purging, and output control tasks.

You can read the program status, unit parameters, and flame signal level directly on the unit. You can also control the burners manually for commissioning and diagnostic purposes. If the local requirements on the burner control unit change, the PC software BCSoft can be adjusted to the unit parameters of the application. To support service personnel, BCSoft offers a convenient visualization system of the input and output signals and the error history.

- Plug-in function unit for mounting in 19" module subracks
- Displays program status, unit parameters, and flame signal
- Manual mode for burner adjustment and diagnostics
- Reduce installation and wiring costs by transferring the control signals and feedbacks with field bus interface PFA 700 via PROFIBUS-DP
- Certified for systems up to SIL 3 and compliant with PL e



Model Selection Guide

Description	Trial for Ignition Timing	Catalog Number	Price
No air valve control			
PFU 760N	5 seconds	88650459	\$518.00
	10 seconds	88650322	518.00
With air valve control			
PFU 760LN	5 seconds	88650457	598.00
	10 seconds	88650321	598.00
PFU 780LN	5 seconds	88650487	795.00
	10 seconds	88650472	795.00
With air valve control and digital input for high temperature operation			
PFU 760LND	5 seconds	88650483	717.00
	10 seconds	88650485	717.00
PFU 780LND	5 seconds	88650486	914.00
	10 seconds	88650484	914.00

ControlLinks™ Burner Control System



Honeywell ControlLinks™ fuel air ratio control system helps you realize energy savings, increased turndown, reduced emissions, and system reliability in an easy-to-install, powerful, and cost-effective package.

Features

- Stand-alone control system designed for easy retrofits
- Dynamic safety checks: failsafe potentiometer check, anti-swap of actuators, and curve verification algorithms, relay test for limit control input/output (LCI-LCO) contact set
- Integrated shock protection algorithms: Water or stack temperature low fire hold, flue gas recirculation (FGR) hold, FGR and low-fire hold
- Controller LEDs: Power, alarm, motor 1, 2, 3, 4 for status, and fault code annunciation (60 possible)
- Two independent fuel profiles with or without FGR
- Programmable positioning for non-selected fuel actuator, standby, purge, light-off, or minimum/maximum modulation
- Up to four universal parallel positioning actuators: Combustion air, fuel 1, fuel 2, FGR/flexible usage
- Fourth channel actuator flexible usage: FR, secondary air control or modulating fuel valve
- Auto/manual firing rate input
- Seven to 24 points per profile curve with quick setup feature, providing minimum three-point profile curve
- Actuator CW/CCW switches for manually driving hub — useful for installation and service
- Actuator LED annunciation for unconfigured, configured, on-line, or faulty actuator states

Honeywell ControlLinks™ replaces the traditional single point modulation of a mechanical cam-and-linkage assembly that controls the relationship between fuel, airflow, and flue

For boilers and burners up to 300 HP!

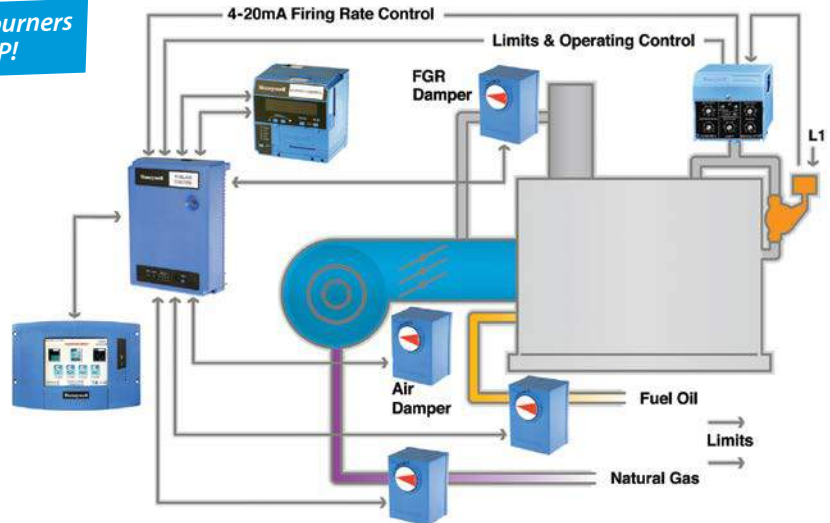

Typical boiler application with Honeywell ControlLinks™ fuel ratio control system installed.

gas recirculation on a power burner. The linkageless fuel air ratio control provides more accuracy and efficiency in actuator positioning and burner firing, reducing your service requirements and downtime. It can be installed as part of a retrofit or a new burner application —anywhere increased efficiency is desired.

Up to four independently controlled universal parallel positioning actuators (UPPAs) are managed by the ControlLinks controller, which responds to load and firing rate demands.

ControlLinks can be used on single or combination fuel single burner applications, including power burners, boilers, process furnaces, ovens, smelting, kilns, paint drying booths, VOC burn-off, ceramics, make-up air heaters, or any full modulating burner.



R7999A ControlLinks™ Fuel Air Controller

Uses the latest microprocessor technology to simultaneously control up to four actuators. Use with ML7999 actuators to replace mechanical cam-and-linkage assembly controlling the relationship between fuel, airflow, and flue gas recirculation (FGR) on a power burner.

Fast burner setup vial PC or laptop. Two independent fuel profiles with or without FGR. Programmable behaviors of all actuators during purge and standby. Programmable behavior of non-selected fuel actuator. Independent light off and minimum modulation positions. Auto/manual input and manual mode firing-rate input. Multipurpose communications port.

ZM7999A ControlLinks™ configuration software tool lets you create burner modulation curves (profiles) for your burners, for safe and efficient operation at all points along the curve. Wizards step you through the commissioning process. Save files on your PC to use over again.

Complete System Requires: R7999 controller, Q7999 wiring subbase, ML7999 positioning actuator, and ZM7999 configuration software.

Model Selection Guide

Description	Catalog Number	Price
Fuel air ratio controller, 100-120 VAC, 50/60 Hz	R7999A1005	\$977.05
Field wiring terminal subbase for R7999A controller. Panel mount, NEMA 1 enclosure	Q7999A1006	124.24
ControlLinks™ Windows-based configuration software for R7999A controllers	ZM7999A1006	470.62





Learn more online at www.Lesman.com!



Call for adapter assemblies for connecting to shaft sizes other than 1/2".

ML7999 Universal Parallel-Positioning Actuators

ControlLinks™ actuators control the position of primary and secondary fuel valves, combustion air damper, and flue gas return dampers. UL, CSA, CE approved.

Vibration: 0.0 to 0.5g continuous

Environmental Conditions: Ambient Temperature: -40° to 140°F; Operating Temperature: -40° to 150°F; Operating Humidity: 5% to 95% RH, non-condensing



Model Selection Guide

Actuator Description and Function	Catalog No.	Price
Pulse-width modulating control of combustion air dampers, butterfly gas valves, oil modulation valves, and flue gas recirculation systems. Includes precise feedback potentiometer and integral power supply. Parallel-positioning actuator.	ML7999A2001	\$378.36
Provides 4-20 mA control input to control combustion air dampers and modulation valves. Includes precision drive shaft control and integral power supply capable of direct line voltage connection. Direct coupled actuator.	ML7999B1002	681.93



NEW



S7999D Combustion System Operator Interface

Monitor up to 99 burner systems connected via Modbus. Each burner control, fuel/air ratio control, expanded annunciator or other Modbus devices present on the burner system can be viewed individually to determine its status.

Display: Color 7" touchscreen interface with screen saver, contrast and volume controls

Communications: Two RS485 Modbus ports for monitoring up to 99 unique controls

Function: Allows setup and monitoring of R7999 ControlLinks controller, programmable expanded annunciator terminal remaining, and R7999 EEPROM backup and restore

Model Selection Guide

Description	Catalog Number	Prices Start at
Touchscreen display for ControlLinks™ system. 18-30 VAC input power	S7999D1048	\$1347.37



P7810C Pressuretrol® Controller

Line voltage pressure controller that eliminates the need for a controller and transmitter. One unit does on/off control, high limit and 4-20 mA modulation.

Accuracy: ±4.0% full scale output over operating temperature (32° to 140°F)



Model Selection Guide

Description	Catalog Number	Prices Start at
Solid State Pressuretrol® Controller with On/Off Control, Limit Control, and 4-20 mA Modulation. FM, CSA, UL Approvals. LED Indicators for Power, Call for Heat Function, and Lockout Status	0-15 PSI	P7810C1000 \$706.31
	0-150 PSI	P7810C1018 785.59
	0-300 PSI	P7810C1026 877.30
Siphon Loop with 1/4" NPT Threads for P7810C	209731A	131.34

ControlLinks™ Accessories

Model Selection Guide

Description	Catalog Number	Prices Start at	Description	Catalog Number	Prices Start at
ML7999 actuator shaft adapter for and 3/8" round or square valve shaft	201391	\$4.68	ML7999 actuator 3/4" shaft adapter assembly	32003168-001	76.94
ML7999 actuator weatherproofing kit (1 corner stop, 2 gaskets)	32002935-001	26.88	ML7999 actuator 5/8" shaft adapter assembly	32003168-002	76.66
			ML7999 actuator 9/16 shaft adapter assembly	32003168-003	76.66
			R7999 3-pin electrical connector	32002515-001	13.67



Honeywell
MAXON

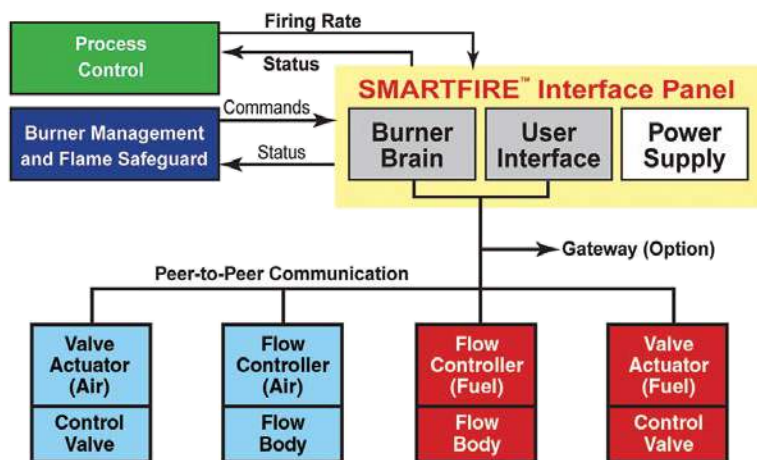

SMARTFIRE® Intelligent Combustion Control System

- Turnkey system for easy installation and setup
- Rugged industrial design includes NEMA 4X enclosures, high torque actuators, and all-digital field device communications, ensuring reliable operation in harsh environments
- Precise electronic control of air and fuel flow to the burner to maximize efficiency and minimize emissions simultaneously
- Maintains emissions or fuel efficiency over the entire operating range of the burner, not just at one burner setpoint
- Automatically compensates for changes in combustion or process conditions with full cross-limited ratio control, maximizing burner performance and ensuring a highly repeatable heat source
- Integrates easily with all burner management systems, reducing engineering costs in retrofit applications
- Advanced diagnostics and troubleshooting provide real-time information about combustion and process system performance
- Redundant system safety checks built into intelligent components significantly reduces the risks associated with combustion system commissioning and maintenance neglect

- FM and CSA approved, and meets requirements of European EMC and low-voltage directives



- Remote monitoring gateway option reduces process downtime by providing immediate off-site technical support over a phone line

Maxon's SMARTFIRE® is an automated fuel/air ratio control system that provides precise thermal mass flow control of your critical burner systems. The flow control valve system is comprised of five components that integrate easily with a conventional burner management system and pipe train.

SMARTFIRE® provides precise electronic control of air and fuel flow to the burner, maintaining emissions or fuel efficiency over the entire operating range of the burner. It automatically compensates for changes in combustion or process conditions with full cross-limited ratio control, ensuring a highly repeatable heat source. SMARTFIRE® valves provide real-time information about combustion and process system performance, as well as optional data logging and remote monitoring. In most installations, SMARTFIRE® contributes to reduced fuel bills, emissions compliance, and maximized uptime on critical industrial heating equipment.

SMARTLINK® Thermal Mass Flowmeter

SMARTLINK® Meter is a highly accurate and repeatable mass flowmeter for monitoring fuel and air.

- Displays instantaneous standard rate and totalized flow without calculations
- Advanced temperature compensation extends accuracy over wider ranges of fluid temperatures
- Redundant meter provides on-line self-checking for safe operation and fail-safe alarm output
- Monitors, displays, and outputs air/fuel ratio when two meters are electrically "linked" to each other
- In-line flow body uses conditioning screens to reduce straight-run pipe requirements and eliminate installation problems

- Large local display for ease of use. No PC or other interface necessary for configuration and operation
- Fail-safe alarm, limit and analog outputs for easy integration into PLC or DCS systems
- FM approved for Hazardous Locations, Class 1, Div 2 Groups A-D and Class 1, Zone 2, Group IIC

Look for more information on Maxon combustion control systems, burners, and valve products online at bit.ly/maxon-combustion





SMARTLINK® MRV Micro-Ratio Valve with Electronic Linkage

- Precise and repeatable flow control optimizes fuel efficiency, enables accurate temperature control and lowers burner emissions
- Synchronous control of up to four valves with conventional signal from your process controller
- Stores 22 point customized profile for each valve
- Standby, purge and light off positions can be defined independent of valve profiles
- UL and CE approved electronics and software for air-fuel ratio control
- FM approved as non-incendive for Class I, Div 2, Groups A-D, and T4; NEMA 4X standard actuator

Today's advanced industrial burner systems use advanced ratio control to minimize emissions while maximizing efficiency. Maxon SMARTLINK® MRV flow control valves provide that control and more.

An electronic parallel positioning system for air: fuel ratio control, SMARTLINK MRV is the industry standard in gas valves when operational reliability and precision are required. MAXON's complete SMARTLINK system includes up to four gas valves and a Control Interface Unit to electronically link the valves to your process controller. Each flow control valve is continuous duty and fully adjustable to 0.1% accuracy to provide dynamic control of burner ratios for optimal performance.

Get full specs and learn more at bit.ly/smartlink-mrv

SMARTLINK® DS Heavy-Duty Quarter-Turn Intelligent Control Actuator



Honeywell Maxon's SMARTLINK® DS is an intelligent control actuator that delivers precise positioning and low maintenance for continuous duty operation. SMARTLINK DS fits in commercial and industrial applications for air, fuel, gas, steam, and chemical control.

SMARTLINK DS comes standard with 4-20 mA output and Modbus communications, with and optional on-board display to simplify commissioning and troubleshooting.

- Available as a standalone unit or direct coupled with Maxon's butterfly and ball valve lines
- Compact actuator can be mounted in any position
- Two-line backlit display and input buttons for fast on-site commissioning
- High (900 in-lb/75 ft-lb) or low torque (300 in-lb/25 ft-lb) models with your choice of AC or DC power
- Accurate to 0.1° over 100° rotation or a maximum of 1000 position points over the full range of operation
- Operating temperature range of -40° to 158° F
- Available for general service or FM Approved for Class I, Div 2 use

Get full specs and learn more at bit.ly/smartlink-ds

Specifications and Model Selection Guide

Torque	300 in-lb	300 in-lb	900 in-lb	900 in-lb
Torque rating in Ft-Lb (Nm)	25 (33)		75 (101)	
Supply Voltage	100-240 VAC ±10% 50/60 Hz	24VDC	100-240 VAC ±10% 50/60 Hz	24VDC
Average Power	19 Watts	17 Watts	19 Watts	17 Watts
Shaft Configurations When No Valve is Selected	1/2" keyed output shaft w/1/8" square key		17mm keyed output shaft w/5mm square key	
Torque Travel Timing	15 seconds (100° degree travel)		45 seconds (100° degree travel)	
Actuator Size with Brake Option	6" x 4.4" x 11.5"	4" x 4.4" x 11.5"	6" x 4.4" x 11.5"	4" x 4.4" x 11.5"
Mounting Bracket Shaft Configuration Options	1/2" keyed output, linkage arm, 1/2" square output, 3/4" square output		17mm keyed output, 1/2" square output, 3/4" square output	
Standard Size	6" x 4.4" x 9.5"	4" x 4.4" x 9.5"	6" x 4.4" x 11.5"	4" x 4.4" x 11.5"
Weight	15 lbs.	14.5 lbs.	16 lbs.	15.5 lbs.
Actuator Catalog Number	DSSA-0000-CA001	DSSA-0000-CB001	DSSA-0000-DA001	DSSA-0000-DB001
Price	\$3351.00	\$2970.00	\$6142.00	\$5761.00

Call Lesman for compatible valves.

V5055 Industrial Gas Safety Shutoff Valve



Safety shutoff valves used with V4055 fluid power actuators to control natural or LP gas flow to commercial and industrial burners. Mounts directly in gas supply line.

Temperature Range: -40°F to 150°F

Includes: 1/4"–18 NPT upstream and downstream taps and plugs

Proof of Closure: V5055C valves have double seal and are used with V4055D and V4055E actuators to provide proof-of-closure switch and valve seal over-travel interlock

Approvals: FM, CSA, and UL



Get full specs and learn more at bit.ly/v5055-valves

V4055 On-Off Gas Valve Actuator

Use with Honeywell V5055 gas valves where smooth light off is important to control gas supply to industrial burners.

One second maximum closing time. Continuous display of valve position with a red (open) or yellow (closed) indicator. Provides final safety shutoff service when used with V5055 valves.

Temperature Range: -40° to 150°F

Operating Pressure: 5 psi maximum

Electrical Rating: 120 VAC, 60 Hz

Auxiliary Switch Contact Ratings: 9.8 AFL, 55.8 ALR, 1/2 hp

Proof of Closure Switch Contact Ratings (V4055D): 4.9 AFL, 29.4 ALR, 1/2 hp; 9.8 AFL, 58.8 ALR, 1/2 hp



Get full specs and learn more at bit.ly/v4055

Model Selection Guide: V5055 Valves and V4055 Actuators

Description	Pipe Size	Capacity	Operating Differential*	Functions	Catalog Number	Availability	Price
<i>Choose a V5055 safety shutoff valve</i>							
	1/5" NPT	1717 cf ³ /hr – 48.6 m ³ /hr	5 PSI max	On/off safety shutoff	V5055A1020	↓	\$399.85
	2" NPT	3620 cf ³ /hr – 48.6 m ³ /hr	5 PSI max	On/off safety shutoff with double seal for proof of closure	V5055C1000	↓	973.70
	2.5" NPT	4250 cf ³ /hr – 48.6 m ³ /hr	5 PSI max	On/off safety shutoff with double seal for proof of closure	V5055C1018	↓	1141.83
	3" NPT	4250 cf ³ /hr – 48.6 m ³ /hr	5 PSI max	On/off safety shutoff	V5055A1053	↓	894.26

<i>Choose a V4055 actuator</i>							
	On-Off actuator, 90° stroke internal auxiliary switch, 13-second open time.				V4055A1296	•	\$744.76
	On-Off actuator with damper shaft, 13-second open time.				V4055A1098	•	668.12
	On-Off actuator, 13-second open time.				V4055A1031	•	668.12
	On-Off actuator with damper shaft, 26-second open time.				V4055A1064	•	618.56
	On-Off actuator, 26-second open time.				V4055A1007	•	618.56
	On-Off actuator with NEMA 4 enclosure, 26-second open time.				V4055A1312	•	1307.73
	On-Off actuator with internal auxiliary switch and Proof of Closure switch. 13-sec.open time.				V4055D1035	• •	800.09
	On-Off actuator with damper shaft and Proof of Closure switch. 13-second open time.				V4055D1019	• •	723.69
	On-Off actuator with Proof of Closure switch. 13-second open time.				V4055D1043	• •	720.11
On-Off actuator with damper shaft and Proof of Closure switch. 26-second open time.				V4055D1001	• •	720.11	

* When used with V4055A or D models. 15 PSI when used with V4055B, E, F, or G models.



Look for the  for in stock models normally available to ship within 24 hours.



Honeywell Electromechanical Valves for Gas Service



- Valve sizes: 3/4" to 3" with NPT connection; 4" & 6" with flanged connections
- Field-rotatable top assemblies in 90° increments to fit your application
- Actuators available with manual reset or automatic reset operators
- Visual position indication standard
- Overtravel switches for open and closed position

- Electrically actuated valves with powerful closing spring provide closure in less than one second
- FM, CSA, UL, and CE approved
- Available for non-incendive Class I, Div 2 areas; Full assessment to IEC 61508 as SIL 3 capable; Designed to meet Fluid Control Institute (FCI) 70-2 control valve standard for Class VI seat leakage



Model Selection Guide

Normally closed automatic shutoff valve for natural gas. Top assembly position: right. Trim package: cast iron body, 400 series stainless steel seat, hardened ductile iron disc, PEEK follower ring, Buna N o-rings and bumper, 115 VAC, 60 Hz voltage, NEMA 4 enclosure.

Number of Switches	Connection Type	Timing	Valve Size	Cv	Operating Pressure Differential	Catalog Number	Price
2 proof of open switches, 2 proof of closure switches	NPT Threaded	6 seconds	1.5" (DN40)	53	70 PSIG max.	150SMA11-AA11-BB22A0	\$2104.00
			2" (DN50)	86	70 PSIG max.	200SMA11-AA11-BB22A0	2439.00
			2.5" (DN65)	127	40 PSIG max.	250CMA11-AA11-BB22A0	3466.00
			3" (DN80)	423	30 PSIG max.	300CMA11-AA11-BB22A0	3655.00
1 proof of open switch, 1 proof of closure switch	NPT Threaded	6 seconds	0.75" (DN20)	19	125 PSIG max.	075SMA11-AA11-BB21A0	1760.00
			1" (DN25)	20	125 PSIG max.	100SMA11-AA11-BB21A0	1790.00
			1.25" (DN32)	45	100 PSIG max.	125SMA11-AA11-BB21A0	1801.00
			1.5" (DN40)	53	70 PSIG max.	150SMA11-AA11-BB21A0	1854.00
			2" (DN50)	86	70 PSIG max.	200SMA11-AA11-BB21A0	2266.00
			2.5" (DN65)	127	40 PSIG max.	250SMA11-AA11-BB21A0	2459.00
	ANSI Flanged	6 seconds	3" (DN80)	423	30 PSIG max.	300SMA11-AA11-BB21A0	2631.00
			2.5" (DN65)	304	50 PSIG max.	250CMA11-BA11-BB21A0	3523.68
			3" (DN80)	173	40 PSIG max.	300CMA11-BA11-BB21A0	3654.00
			4" (DN100)	490	40 PSIG max.	400CMA11-BA11-BB21A0	3819.00
			4" (DN100)	719	60 PSIG max.	400HMA11-BA11-BB31A0	8452.00
			6" (DN150)	1172	50 PSIG max.	600HMA11-BA11-BB31A0	10670.00

NORMALLY AVAILABLE FROM STOCK

Need to rotate your Maxon valve 180°?

See how at bit.ly/rotate-maxon-valve

More sizes and options available. Call 800-953-7626 for help configuring a valve for your application.

Electromechanical Valves for Oil Service

- Line sizes from 3/8" to 6" diam., Cv flow factors to 1230, line pressures to 600 PSIG
- Top assembly enclosures meet NEMA 1, 3, 3S, 4, and 12, CSA 2, 4, and 5; Also available with NEMA 4X trim
- Normally closed valves for quick, reliable shut-off of gas or oil lines; Normally open versions for vent or process purge lines
- Choice of manual reset or automatic reset motorized operators
- Minimal line pressure drops with straight-through flow swinging gate or rising stem valve bodies



8000 Series Air Actuated Valves for Oil and Gas

- Available in 3/8" to 2" line sizes and line pressures up to 740 PSIG
- Pneumatically actuated valves with powerful closing spring for reliable operation
- Top mounted 360° open-shut visual position indication
- Cast iron and carbon steel body assemblies with internal trim options to handle general purpose or severe fluids
- Compact design with integral solenoid, quick exhaust and position switch
- FM, CSA approved safety shut-off valves; Hazardous location approved: Intrinsically Safe for Class I, Div. 1 (and ATEX Zone 2/22 when ordered with the ATEX IS solenoid); Non-Incendive for Class I, Div. 2; NACE-compliant trims available



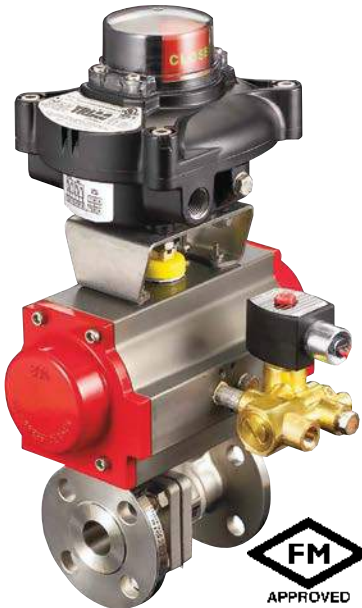

Need valves cleaned for oxygen service? Just ask.

FM Approved Ball Valves for Safety Shut-Off

FM approved for use in applications that require protection for fuel-burning equipment per FM class 7400, 7420, and 7422. Available in threaded or ANSI flange design, in sizes from 1/4" to 6". Components include a spring-return automated ball valve, explosion-proof limit switch, and a solenoid pilot valve.

Assemblies feature the latest in quarter-turn automation and rack-and-pinion actuator design, for a marked improvement over older spring-diaphragm technology.

The actuator, combined with the superior valve seating and stem seal design, provides for reliable and consistent closure in a compact fuel gas safety shut-off system.

- Pyramidal stem seal system
- 316 stainless steel or carbon steel bodies, reinforced Teflon seat
- Solenoids approved for waterproof and explosion-proof environments
- Two SPDT mechanical limit switches, 5 Amp, NEMA 4, 4X, 7, and 9

Body: Choice of 316 stainless steel or carbon steel

Approvals: FM Class 7400, 7420, and 7400

Maximum Operating Pressure (depends on valve size): F88 (threaded) carbon steel: 1000 to 1450 PSI at 100°F; F88 stainless steel: 1000 to 1440 PSI at 100°F; F9D (flanged) carbon steel: 285 to 740 PSI at 100°F; F9D stainless steel: 275 to 720 PSI at 100°F

Limit Switch: Standard: Two 5 Amp SPDT mechanical switches, NEMA 4, 4X, 7, and 9. Optional: Two 5 Amp DPDT mechanical switches, two 1 Amp SPDT proximity switches, or two 5 Amp SPDT mechanical switches with 4-20 mA position transmitter

See model selection guide on next page

NEW

Honeywell SV2 Series Safety Shut-off Valve

The Honeywell SV2 series safety shut-off valve is a smart valve that increases productivity and reduces assembly time. This valve performs the actions of six different segments making shipping less costly and reducing installation time.

The SV2's stepper motor helps produce a smooth start, cutbacks in adjustments, and the ability to fix the amount of CO2, making it energy efficient.

- 3-in-1 Pressure module with sensors
- Embedded Valve Proving Sequence
- Intuitive user interface
- Can be configured in multiple ways for different inputs

Intelligent Features

Features	Basic SV20	Standard SV200	Elite SV2000*
Leak detection			✓
Internal VPS			✓
External efficiency		✓	
Premix efficiency		✓	✓
Self-diagnostics		✓	✓
HMI interface		✓	✓
Communication bus		✓	✓
Smart pressure module		✓	✓
C6097 pressure switch	✓		
Proof of closure	✓	✓	✓
NEMA 1/IP20 enclosure	✓	✓	✓

* Models with Elite SV2000 features coming soon.

Honeywell



Model Selection Guide

Description	Valve Size	Catalog Number	Price
SV2 On/Off Valve, 100–120 VAC, 50/60Hz, NPT ports, 10 PSI max inlet pressure, NEMA 1/IP20 Enclosure with Electrical and Conduit Connections, Right Hand Electronics Orientation [1]			
Basic	1"	V2F2BN425RNNNU0000	\$4045.39
Intelligence Features	1.5"	V2F2CN425RNNNU0000	5759.89
	2"	V2F2DN425RNNNU0000	6251.09
Standard Intelligence Features	1"	V2F2BN426RNNNU0000	5008.58
	1.5"	V2F2CN426RNNNU0000	6636.37
	2"	V2F2DN426RNNNU0000	7127.60

[1] Replace R with L in the Catalog Number for left hand electronics orientation



Dimensions: F88 Three-Piece Threaded Assembly

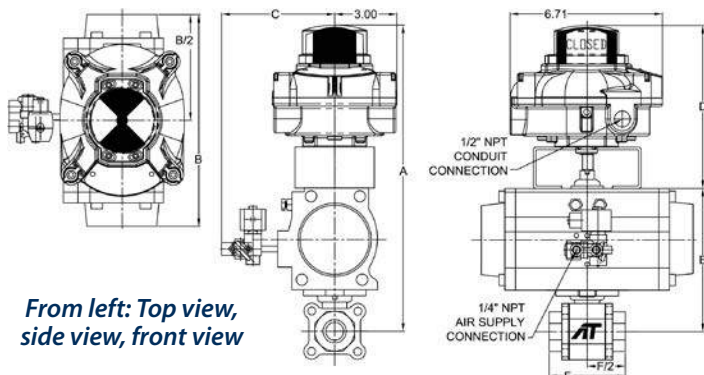

From left: Top view, side view, front view

Dimensions: FD9 ANSI Flanged Assembly

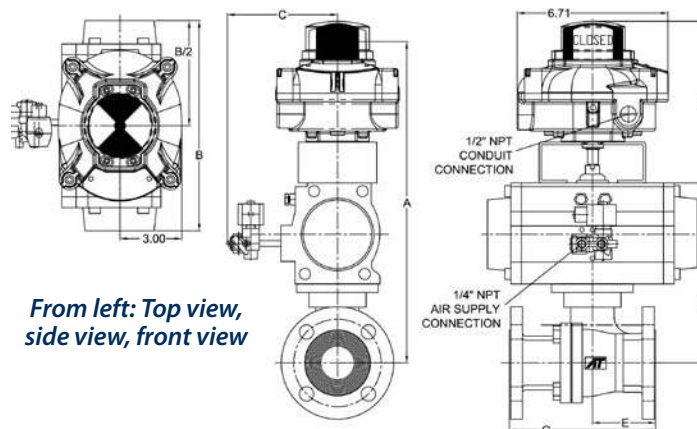

From left: Top view, side view, front view

Model Selection Guide — Ball Valves with Gas Safety Shutoff Assembly

Valve Size	Valve Cv	Valve Dimensions			Actuator Dimensions			Carbon Steel Valve		Stainless Steel Valve	
		A	C	F	B	D	E	Catalog Number	Price	Catalog Number	Price

Model F88 FireSafe NACE, Three-Piece Full Port Ball Valve, Direct Mount Gas Safety Shutoff Assembly

1/4"	7	12.14	6.60	2.95	8.00	7.05	5.09	SS-8C-TX-025-6AA	\$ 1432.00	SS-8S-TX-025-6AA	\$ 1420.00
3/8"	8	12.14	6.60	2.95	8.00	7.05	5.09	SS-8C-TX-038-6AA	1432.00	SS-8S-TX-038-6AA	1420.00
1/2"	15	12.14	6.60	2.85	8.00	7.05	5.09	SS-8C-TX-050-6AA	1440.00	SS-8S-TX-050-6AA	1437.00
3/4"	40	13.37	5.98	3.36	9.34	7.05	6.32	SS-8C-TX-075-6AA	1530.00	SS-8S-TX-075-6AA	1515.00
1"	70	13.85	5.98	4.25	9.34	7.05	6.80	SS-8C-TX-100-6AA	1584.00	SS-8S-TX-100-6AA	1583.00
1 1/4"	110	14.00	5.98	4.37	9.34	7.05	6.95	SS-8C-TX-125-6AA	1649.00	SS-8S-TX-125-6AA	1639.00
1 1/2"	250	15.04	6.22	5.01	10.92	7.05	7.99	SS-8C-TX-150-6AA	1880.00	SS-8S-TX-150-6AA	1867.00
2"	430	15.75	6.39	5.62	11.51	7.05	8.70	SS-8C-TX-200-6AA	2218.00	SS-8S-TX-200-6AA	2201.00
2 1/2"	600	17.51	6.85	7.28	13.92	7.05	10.46	SS-8C-TX-250-6AA	2633.00	SS-8S-TX-250-6AA	2547.00
3"	1100	17.51	6.85	8.07	13.92	7.05	10.81	SS-8C-TX-300-6AA	2999.00	SS-8S-TX-300-6AA	2892.00
4"	2200	19.67	7.20	9.45	15.20	7.48	12.19	SS-8C-TX-400-6AA	3573.00	SS-8S-TX-400-6AA	3410.00

Valve Size	Valve Cv	Valve Dimensions				Actuator Dimensions			Carbon Steel Valve		Stainless Steel Valve	
		A	C	E	G	B	D	F	Catalog Number	Price	Catalog Number	Price

Model FD9 Firesafe NACE, ANSI #150 Flanged Full Port Ball Valve Gas Safety Shutoff Assembly

1/2"	15	12.32	6.60	1.84	4.26	8.00	7.05	5.27	SS-9C-FX-050-6AA	\$ 1500.00	SS-9S-FX-050-6AA	\$ 1535.00
3/4"	45	13.56	5.98	2.18	4.62	9.34	7.05	6.51	SS-9C-FX-075-6AA	1586.00	SS-9S-FX-075-6AA	1591.00
1"	85	13.85	5.98	2.21	5.00	9.34	7.05	6.80	SS-9C-FX-100-6AA	1644.00	SS-9S-FX-100-6AA	1649.00
1 1/2"	275	15.84	6.39	2.83	6.50	11.51	7.05	8.79	SS-9C-FX-150-6AA	1986.00	SS-9S-FX-150-6AA	2027.00
2"	460	16.13	6.39	3.38	7.02	11.51	7.05	9.08	SS-9C-FX-200-6AA	2147.00	SS-9S-FX-200-6AA	2205.00
2 1/2"	700	17.80	6.85	3.06	7.48	13.92	7.05	10.75	SS-9C-FX-250-6AA	2719.00	SS-9S-FX-250-6AA	2832.00
3"	1100	18.45	6.85	4.01	8.01	13.92	7.05	11.40	SS-9C-FX-300-6AA	3120.00	SS-9S-FX-300-6AA	3259.00
4"	2200	20.59	7.20	4.07	9.00	15.20	7.48	13.11	SS-9C-FX-400-6AA	4227.00	SS-9S-FX-400-6AA	4472.00
6"	5150	25.88	8.22	7.00	15.50	24.37	7.48	18.40	SS-9C-FX-600-6AA	7812.00	SS-9S-FX-600-6AA	8468.00

Model FD9 Firesafe NACE, ANSI #300 Flanged Full Port Ball Valve Gas Safety Shutoff Assembly

1/2"	15	12.32	6.60	1.84	4.26	8.00	7.05	5.27	SS-9C-3X-050-6AA	1544.00	SS-9S-3X-050-6AA	1554.00
3/4"	45	13.56	5.98	2.18	4.62	9.34	7.05	6.51	SS-9C-3X-075-6AA	1670.00	SS-9S-3X-075-6AA	1682.00
1"	85	13.85	5.98	2.21	5.00	9.34	7.05	6.80	SS-9C-3X-100-6AA	1752.00	SS-9S-3X-100-6AA	1769.00
1 1/2"	275	15.84	6.39	2.83	6.50	11.51	7.05	8.79	SS-9C-3X-150-6AA	2189.00	SS-9S-3X-150-6AA	2261.00
2"	460	16.13	6.39	3.38	7.02	11.51	7.05	9.08	SS-9C-3X-200-6AA	2329.00	SS-9S-3X-200-6AA	2420.00
2 1/2"	700	17.80	6.85	3.06	7.48	13.92	7.05	10.75	SS-9C-3X-250-6AA	2982.00	SS-9S-3X-250-6AA	3129.00
3"	1100	18.45	6.85	4.01	8.01	13.92	7.05	11.40	SS-9C-3X-300-6AA	3535.00	SS-9S-3X-300-6AA	3747.00
4"	2200	20.59	7.20	4.07	9.00	15.20	7.48	13.11	SS-9C-3X-400-6AA	5104.00	SS-9S-3X-400-6AA	5434.00
6"	5150	25.88	8.22	7.00	15.50	24.37	7.48	18.40	SS-9C-3X-600-6AA	9273.00	SS-9S-3X-600-6AA	10113.00

ASCO[®] Solenoid Valves for Combustion Systems

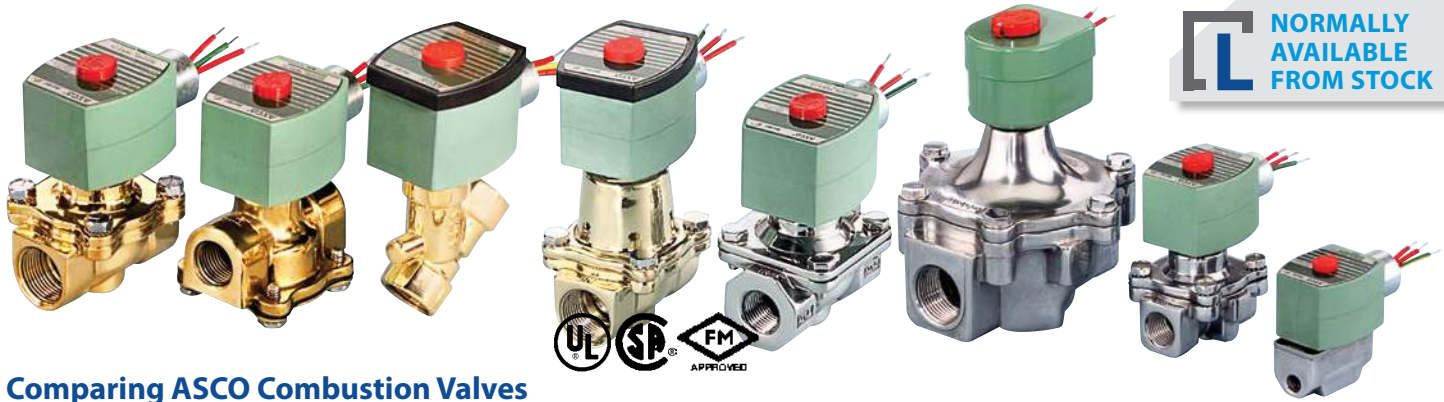

Comparing ASCO Combustion Valves

Series	8030	8040	8210	8214	8215	8262
Material	Brass body	Aluminum body	Brass body	Aluminum body	Aluminum body	Brass body
Approvals	UL, FM, CSA	UL, CSA, FM (3/8" to 3/4" only)	UL, FM, CSA	UL, FM, CSA	UL, CSA, FM (except 8215A090 and 8215A040)	UL, FM, CSA

Model Selection Guide

120 volts AC/60 Hz — All Valves Shown Here are Normally Closed (Closed when De-Energized), for Use in Fluids to Maximum Temperatures 125°F

Pipe Size	Orifice Size	Cv Flow Factor	Gas Capacity BTU/Hr	Operating Pressure Differential (PSI)		Watt Rating Class of Coil Insulation	Solenoid Valve		Repair Kit		Replacement Coil	
				Min.	Max.		Catalog Number	Price	Catalog Number	Price	Catalog Number	Price
Direct Acting Gas Shutoff Valves												
1/8"	5/16"	1	53,700	0	15	6.1/F	8040H006	\$80.00	318247	\$65.00	238210-032-D	\$104.00
1/4"	5/16"	1.1	59,000	0	15	10.1/F	8040H007	81.00	318247	65.00	238210-032-D	104.00
3/8"	3/8"	1.8	97,000	0	15	10.1/F	8030G068	200.00	306628	148.00	238610-032-D	114.00
1/2"	7/16"	2.8	151,000	0	8	10.1/F	8030G069	204.00	306629	165.00	238610-032-D	114.00
1/2"	3/4"	5.4	291,000	0	2	10.1/F	8040G022	160.00	306633	90.00	238610-032-D	114.00
3/4"	3/4"	9.5	512,000	0	2	10.1/F	8040G023	161.00	306633	90.00	238610-032-D	114.00
1"	1-5/8"	16.8	900,000	0	0.5	15.4/F	8040C004	208.00	304079	145.00	099257-001-D	151.00
Pilot Operated Gas Shutoff Valves												
3/8"	5/8"	2.8	150,000	0	50	10.1/F	8210G074	211.00	304076	168.00	238610-032-D	114.00
3/8"	3/4"	3.4	183,000	0	50	10.1/F	8215G010	173.00	302350	142.00	238610-032-D	114.00
1/2"	5/8"	3.6	193,000	0	50	10.1/F	8210G075	211.00	304076	168.00	238610-032-D	114.00
1/2"	3/4"	4.4	238,500	0	50	10.1/F	8215G020	173.00	302350	142.00	238610-032-D	114.00
3/4"	5/8"	5.0	295,000	0	50	10.1/F	8210G076	235.00	304076	168.00	238610-032-D	114.00
3/4"	3/4"	5.1	247,500	0	50	10.1/F	8215G030	183.00	302350	142.00	238610-032-D	114.00
1"	1-5/8"	21	1,119,000	0	25	15.4/F	8215B050	333.00	302352	260.00	099257-001-D	151.00
1-1/4"	1-5/8"	32	1,730,000	0	25	15.4/F	8215B060	333.00	302352	260.00	099257-001-D	151.00
1-1/2"	1-5/8"	35	1,900,000	0	25	15.4/F	8215B070	384.00	302352	260.00	099257-001-D	151.00
2"	2-3/32"	60	3,251,000	0	25	15.4/F	8215B080	561.00	302353	358.00	099257-001-D	151.00
2-1/2"	3"	117	5,821,000	0	5	28.2/F	8215A090	835.00	302354	524.00	206409-011-D	404.00
3"	3"	138	7,430,000	0	5	28.2/F	8215A040	1072.00	302354	524.00	206409-011-D	404.00
Gas Shutoff Valves with Waterproof Enclosures												
3/8"	3/4"	3.4	183,000	0	5	17.1/F	8214G010	168.00	316233	134.00	238610-132-D	143.00
1/2"	3/4"	4.4	238,500	0	5	17.1/F	8214G020	168.00	316233	134.00	238610-132-D	143.00
3/4"	3/4"	5.1	247,500	0	5	17.1/F	8214G030	172.00	316233	134.00	238610-132-D	143.00



ASCO® 8214 Series 2-Way Gas Safety Shutoff Valves

Features

- FM approved as safety shutoff valve with visual indicator and proof-of-closure switch options (Suffix "VI" & "C")
- For on-off control of fuel gas in commercial and industrial gas burners
- Unique double disc design with overtravel provides redundant sealing for leak tight shutoff
- Zero differential piloted diaphragm
- Valves provided with 1/8" NPT upstream and downstream pipe taps with plugs for routine testing
- Optional flange adapters for ease of installation and service
- Modular design for flexibility to configure double solenoid gas train with a small footprint
- Low ambient operating temperature range — valves can be installed in frigid environments as low as -40° C/F

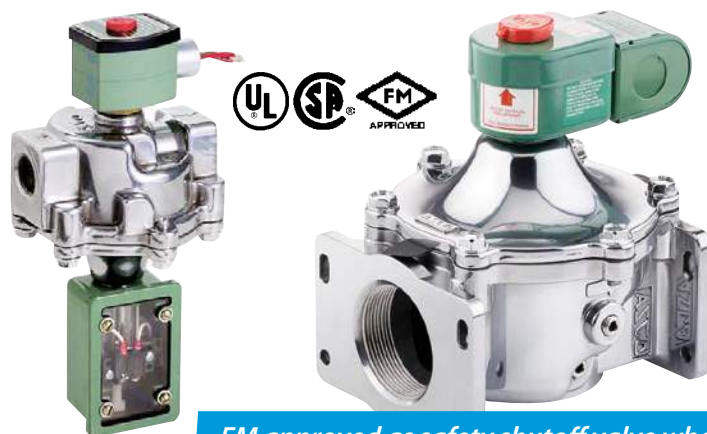

FM approved as safety shutoff valve when ordered with optional visual indication or proof-of-closure switch.

Specifications

Construction: Body: Aluminum; Seals and disc: NBR; Core tube: 305 stainless steel; Core guide: Acetal; Rider ring: PTFE; Core and plugnut: 430F SS; Springs: 302 SS; Shading coil: Copper; Pipe plug: Zinc-plated steel

Standard Voltages: 24, 120, 240 VAC, 60 Hz (or 110, 200 VAC, 50 Hz); 12, 24 VDC; Visual indicator and Proof-of-Closure switch only available on AC constructions

General Purpose Solenoid Enclosures: RedHat metal Type 1; General Purpose housing has a 7/8" diameter hole to accept standard conduit hubs or connectors. Add prefix JB to catalog number for a Junction Box construction with two 7/8" diameter knockouts. (i.e. JB8214 265)

Watertight Solenoid Enclosures: RedHat II molded epoxy Type 1, 2, 3, 3S, 4 and 4X combination. General Purpose and Watertight solenoid enclosures with 1/2" conduit hub as standard.

Valve Response Time: Opening Time: <1 second; Closing Time: <1 second

Approvals: UL Listed: Standard 429 "Electrically Operated Valves," Guide Y10Z, File MP618 Safety Shutoff Valves. FM Approved: Class 7400 "liquid and gas safety shutoff valves," when ordered with C, VI options. CSA Certified: Standard C22.2 No. 139 "Electrically Operated Valves," File 010381. Automatic Gas Valves Z21.21 (6.5), C/I, File 112872. 3) Automatic Gas Safety Shutoff Valves (3.9), File 112872.

Model Selection Guide

120 volts AC/60 Hz — All Valves Shown Here are Normally Closed (Closed when De-Energized), for Use in Fluids to Maximum Temperatures 125°F

Pipe Size	Orifice Size	Cv Flow Factor	Gas Capacity BTU/Hr	Operating Pressure Differential (PSI)		Watt Rating Class of Coil Insulation	Solenoid Valve		Replacement Coil	
				Min.	Max.		Catalog Number	Price	Catalog Number	Price

Two-Way, Normally Closed General Purpose Gas Valves (UL, CSA Approved as Safety Shutoff Valves)

1 1/4"	2 3/32"	36	1,925,000	0	5	20/F		8214 265	\$381.00		099257-005-D	\$199.00
1 1/2"	2 3/32"	45	2,406,000	0	5	20/F		8214 275	496.00		099257-005-D	199.00
2"	2/32"	55	2,940,500	0	5	20/F		8214 280	588.00		099257-005-D	199.00

Two-Way, Normally Closed Watertight Gas Valves (UL, CSA Approved as Safety Shutoff Valves). Only available in AC voltages.

1 1/4"	2 3/32"	36	1,925,000	0	5	20/F		8214G266	355.00		272610-132-D	149.00
1 1/2"	2 3/32"	45	2,406,000	0	5	20/F		8214G276	468.00		272610-132-D	149.00
2"	2/32"	55	2,940,500	0	5	20/F		8214G281	555.00		272610-132-D	149.00

Options and Accessories (For AC Voltages Only)

Visual indication of open/shut position (For FM-Approved safety shutoff valve)	Suffix VI	113.00
1 Amp proof of closure switch (For FM-Approved safety shutoff valve)	Suffix C	440.00

Don't see the valve you need?

Give us a call... or visit bit.ly/solenoid-valves

With more than 20,000 variations available, we're sure to have the valve you need!

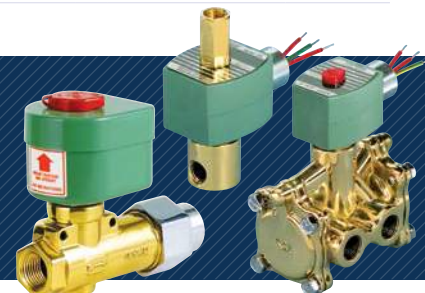

Valvario® VAS Safety Shut-Off Solenoid Valves

Normally closed solenoid valves for gas. For safeguarding and controlling air and gas supply to gas burners and appliances. For use in gas control and safety systems in all sectors of the iron, steel, glass, and ceramics industries, plus commercial heat generation in packaging, paper, and food industries.

- Modular design saves space and piping work
- Main gas valve, pilot valve, regulator and pressure switch are all available for direct "stack" mounting for one small modular footprint
- Changeable mounting plates make it easy to reduce input/output size and flange size. Reduces need for keeping multiple sizes in inventory

- Modular-mount mercury-free pressure switch has test port and <25% deadband
- Can be equipped with Proof of Closure visual indicator
- High flow rate and low pressure drop
- CSA, FM, CE approvals



Honeywell

kromschroder



Specifications

Inlet Pressure: (pe): 7 PSIG max

Non-Operational Pressure: FM approved: 10 PSIG; CSA approved: 5 PSIG

Flow Adjustment: Limits max flow between 20% and 100%. On VAS 1-3 sizes, the setting can be monitored on an indicator

Adjustment of Start Gas Rate: 0% to 70%

Opening Times: VAS/N quick opening: ≤1 sec; VAS/L slow opening: up to 30 sec

Closing Time: <1 second

Ambient Temperature: -4° to 140°F

Safety Valve: Class A, Group 2, pursuant to EN 13611 and EN 161; FM research class 7410 and 7411, ANSI Z21.21, CSA 6.5

Materials: IP65 enclosure; Valve housing: Aluminum, Valve seal: NBR

Voltage: 120 VAC, 50/60 Hz

Current Consumption (at 68°F): Pickup: 1.8 amp; Holding: 0.3 amp

Switching Frequency: 5x per minute, except VAS 9: Once per minute

Switching Cycles: 0.1 amp: 500,000; 0.5 amp: 300,000; 1 amp: 200,000; 3 amp: 100,000

Safety Limit Pressure Switch



Diaphragm-actuated safety limit switch controls rising or falling pressures that must not overshoot or undershoot a set limit value, and controls the minimum or maximum gas inlet pressure of a gas control line.

- For use with natural gas and air
- Die-cast aluminum base, glass-filled PBT switch housing, NBR diaphragm, and polycarbonate cover
- Ambient temperatures 5° to 140°F



Available with pressure regulators, flow rate regulators, double solenoids, and other options. Call 800-953-7626 for pricing and availability.

Model Selection Guide

Description	Catalog Number	Avail-ability	Price
Fast-opening (<1sec) solenoid valve body, Proof-of-Closure switch, right viewing			
Small Valve Body	88003766	↓	\$338.00
Medium Valve Body	88003768	↓	461.00
Large Valve Body	88003765	↓	591.00
Internal thread connection flange: pick two (one inlet, one outlet). NPT flange sizes can differ for inlet and outlet within the same availability column.			
3/8" NPT	74922429	•	10.00
1/2" NPT	74922645	•	10.00
3/4" NPT	74922646	•	33.10
1" NPT	74922647	•	39.40
1" NPT	74922648	•	33.10
1-1/4" NPT	74922649	•	33.10
1-1/2" NPT	74922650	•	39.40
1-1/2" NPT	74922652	•	39.40
2" NPT	74922651	•	39.40
2" NPT	74922653	•	39.40
2-1/2" NPT	74922654	•	58.00
Screw sets for attaching Valvario bodies and flanges (Order two for single valve assemblies. Order three for double-block valve assemblies.)			
Small	74921992	•	11.00
Medium	74921993	•	30.40
Large	74921994	•	38.30
Double block valve assembly accessories (Each double-block assembly requires one gasket kit and one cable grommet.)			
Gasket Kit for Small Valves	74921988	•	19.40
Gasket Kit for Medium Valves	74921989	•	29.50
Gasket Kit for Large Valves	74921990	•	39.40
Cable Grommet for Small Valves	74921985	•	17.60
Cable Grommet for Medium Valves	74921986	•	20.60
Cable Grommet for Large Valves	74921987	•	22.10
Add a DG.VT pressure switch with 4-pin plug, socket, 18" flexible leads			
Model	Adjustable Range		
DG 17/VCT1-6W	0.8" to 6.8" WC	• • •	\$96.00
DG 40/VCT1-6W	2.0" to 16" WC	• • •	96.00
DG 110/VCT1-6W	12" to 44" WC	• • •	96.00
DG 300/VCT1-6W	40" to 120" WC	• • •	96.00



Honeywell BV Butterfly Valves

**krom
schroder**



CE

Need a butterfly valve for flue gas or high temperature air flow rates? Call Lesman for pricing and availability.

High accuracy valves for control of gas flow rates. Mount on IC 20 or IC 40 actuators to regulate flow rates for modulating or stage-controlled combustion systems.

- Low leakage rate and pressure loss
- Temperature range: -4° to 140°F
- Other models available for flue gas and high temperature air flow rates to 840°F. Call Lesman for details

Model Selection Guide

Model	Bore Size	Nominal Diameter	Reduced Nominal Diameter	Catalog Number	Price
<i>Butterfly valve for continuous control of gas flow rates, ratio of 10:1. Maximum inlet pressure 7.25 PSI.</i>					
BVG 40W05	Full	1 1/2"	—	88300141	\$253.00
BVG 50W05	Full	2"	—	88300142	269.00
BVG 65W05	Full	2 1/2"	—	88300143	289.00
BVG 80W05	Full	3"	—	88300144	331.00
BVG 100W05	Full	4"	—	88300145	358.00
BVG 40/32W05	1X Reducing	1 1/2"	1 1/4"	88300146	350.00
BVG 50/40W05	1X Reducing	2"	1 1/2"	88300147	372.00
BVG 65/50W05	1X Reducing	2 1/2"	2"	88300148	393.00
BVG 80/65W05	1X Reducing	3"	2 1/2"	88300149	438.00
BVG 100/80W05	1X Reducing	4"	3"	88300150	479.00
BVG 40/25W05	2X Reducing	1 1/2"	1"	88300151	350.00
BVG 65/40W05	2X Reducing	2"	1 1/2"	88300152	372.00
BVG 50/32W05	2X Reducing	2 1/2"	1 1/4"	88300153	393.00
BVG 80/50W05	2X Reducing	3"	2"	88300154	438.00
BVG 100/65W05	2X Reducing	4"	2 1/2"	88300155	479.00



CE

Compatible Valve Actuators for BV Butterfly Valves

Reversible gear motors to transmit rotary movements between 0° and 90°.

- IC 20 for basic applications with continuous or three-point step control, automatic/manual mode changeover for easy commissioning. IC 20..E is controlled by 0/4-20 mA or 0-10V signal
- IC 40 for complex applications with programmable functions for flexible adjustment to the process. Compatible with BCSOFT for data monitoring, troubleshooting, and programming

Model Selection Guide

Description	Torque (Lb-in)	Run-Time (Over 90° Stroke)	Catalog Number	Price
<i>IC 20 Reversible gear motor, 120 VAC, 50/60 Hz, three-point step</i>				
IC 20-07Q2T	22 Lb-in	7.5 seconds	88300062	\$452.00
IC 20-15Q3T	26.5 Lb-in	15 seconds	88300063	452.00
IC 20-30Q3T	26.5 Lb-in	30 seconds	88300064	452.00
IC 20-60Q3T	26.5 Lb-in	60 seconds	88300065	452.00
<i>IC 20 Reversible gear motor, 120 VAC, 50/60 Hz, continuous control</i>				
IC 20-07Q2E	22 Lb-in	7.5 seconds	88300078	974.00
IC 20-15Q3E	26.5 Lb-in	15 seconds	88300079	974.00
IC 20-30Q3E	26.5 Lb-in	30 seconds	88300080	974.00
IC 20-60Q3E	26.5 Lb-in	60 seconds	88300081	974.00

Description	Torque (Lb-in)	Additional Input/Output Functions	Catalog Number	Price
<i>IC 40 Reversible gear motor, 100-230 VAC, 50/60 Hz</i>				
IC 40A2A	22 Lb-in	4-20 mA input	88300087	\$853.00
IC 40A2R10	22 Lb-in	1000Ω feedback potentiometer	88300084	882.00
IC 40A2AR10	22 Lb-in	4-20 mA input and 1000Ω feedback potentiometer	88300090	959.00
IC 40SA3A	26.5 Lb-in	Safety closing, 4-20 mA input	88300093	1020.00
IC 40SA3AR10	26.5 Lb-in	Safety closing, 4-20 mA input, 1000Ω feedback potentiometer	88300097	1125.00

Accessories

Description	Catalog Number	Price
IC 20/40 Attachment Set	74921671	\$79.00
IC 20/40 Adapter - Free Shaft End	74921676	72.00
IC 20/40 Adapter - Manual Adjustment	74921678	67.00
IC 20/40 Adapter - Square Shaft	74921674	72.00
IC 40 Accessory: Fastening Set IC-BV	74921082	8.90

Honeywell

ECLIPSE™

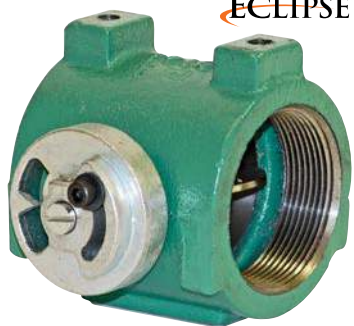

Get full specs and learn more at bit.ly/eclipse-bv

Eclipse BV Butterfly Valves

The Eclipse butterfly valves use pre-heated combustion air for high-low or modulating air control in combustion applications. They can be automated with most types of electric or pneumatic control motors. A slot on the shaft of the valve indicates position of the shutter in manual and automatic valves.

Specifications

Size: 1/2" to 4"; Call for sizes up to 8"

Operating Temperature Range: -40° to 140° F

Operating Pressure Range: to 5 PSI

Materials: Powder coated cast iron body, zinc plated steel shaft, carbon steel disk, Buna-N shaft packing seal

Approvals: UL



Model Selection Guide

Valve Size	Flow Cv	Catalog Number	Price
<i>Eclipse BV full port butterfly valves for automatic applications [1], Beveled Disk, 75° Rotation</i>			
1/2" [2]	5.5	501239	\$208.00
3/4"	15.9	501223	243.00
1"	29.7	501224	250.00
1-1/4"	65.9	501225	266.00
1-1/2"	111	501226	279.00
2"	180	501227	299.00
2-1/2"	322	501228	322.00
3"	457	501229	355.00
4"	819	501230	413.00
Honeywell Modutrol IV Actuator Mounting Kit for 1/2"-4" Valves		100099	109.00

[1] Actuator sold separately

[2] 1/2" valves do not have a mechanical stop limiting the travel to 75° rotation

Honeywell

Modutrol IV Rotary Actuator Motors for Eclipse BV Valves



More Honeywell Modutrol IV motors available online. Visit bit.ly/modutrol for series specifications and model selection guides.

These low torque rotary actuators are reversing, proportional motors used to drive burner firing rate valves, dampers, or auxiliary equipment.



Ambient Temperature: -40° to 150°F (-40° to 66°C)

Crankshaft: Double ended, 3/8" (9.5mm) square

Deadweight Load on Shaft: 200 lb (either end); 300 lb combined power and auxiliary shafts

Power Consumption: 18 W

Voltage: 24 VAC

Switch Ratings: 120 VAC: 7.2 AFL, 43.2 ARL, 40 VA pilot duty opposite contact; 240 VAC: 3.6 AFL, 21.6 ALR, 40 VA pilot duty opposite contact

Compatible Linkage: Q100B1006, connects Modutrol to Eclipse BV butterfly valve above.

Replaces: Retired models M941A, C, and D motors

Approvals: CSA, UL

Model Selection Guide

Stroke 90°	Timing 160°	Torque Rating	Auxiliary Switches	Product Includes	Catalog Number	Price
<i>4-20 mA, 90° to 160° Field-Adjustable Stroke, 120VAC</i>						
30 sec		150 Lb-in	0	Transformer, Screw Terminal Adapters	M7284A1004	\$1114.39
30 sec		150 Lb-in	2	Transformer, Screw Terminal Adapters	M7284C1000	1338.90
<i>Flame Safeguard Firing Rate Motor, 135 Ohm Input Signal, 90° to 160° Field-Adjustable Stroke, 24 VAC</i>						
15 sec	30 sec	75 Lb-in	1	Tapped Shaft	M9484E1009	1283.74
30 sec	60 sec	150 Lb-in	0		M9484D1010	1077.59
30 sec	60 sec	150 Lb-in	1		M9484E1017	1264.77
30 sec	60 sec	150 Lb-in	2	Tapped Shaft, Ships in 90° Position	M9484F1031	1362.84

Looking for motors and pneumatic drives for damper control?

Honeywell

HercuLine 2000 Series Electric Actuators



- No-burnout motor, low power consumption
- Two end-of-travel electric limit switches standard
- Up to four additional SPDT auxiliary switches
- Optional manual handwheel
- Mounting plates adapt to Invensys (Barber-Colman) or Siemens (Landis & Staefa) mountings
- CSA, UL, CE certification, MENA 4/IP67



Honeywell

krom
schroder



DG Pressure Switches

Monitors positive air and gas pressures, negative or differential air pressures in industrial and commercial applications.

- Accurate repeatable switching action with low hysteresis
- Die-cast aluminum alloy base, glass fiber-reinforced plastic switch housing, nitrile rubber diaphragm, and high-quality injection-molded plastic covers
- One normally open and one normally closed contact in each switch (5A resistive or 0.5A inductive)
- Automatic and manual reset models
- 8A quick-acting fuse for short circuit protection
- FM approved, cULus listed



Models Selection Guide

Description	Adjustable Range	Connection	Crossover From Honeywell C6097 Model Number	Catalog Number	Price
DG..T pressure switch with 110V control lamp (green) for positive, negative, and differential pressure, automatic reset					
DG 6T	0.2" to 2.4" WC	2 x 1/4" NPT	—	84447802	\$97.00
DG 10T	0.4" to 4" WC	2 x 1/4" NPT	C6097A1004	84447812	97.00
DG 50T	1" to 20" WC	2 x 1/4" NPT	C6097A1053	84447822	97.00
DG 150T	12" to 60" WC	2 x 1/4" NPT	C6097A1079	84447832	97.00
DG 500T	40" to 200" WC	2 x 1/4" NPT	C6097A1137	84447842	97.00
DG..HT pressure switch with manual reset, locks on pressure rise					
DG 10HT	0.4" to 4" WC	2 x 1/4" NPT	—	84447912	116.00
DG 50HT	1.0" to 20" WC	2 x 1/4" NPT	C6097B1028	84447922	116.00
DG 150HT	12" to 60" WC	2 x 1/4" NPT	C6097B1002	84447932	116.00
DG 500HT	40" to 200" WC	2 x 1/4" NPT	C6097B1051	84447942	116.00
DG..NT pressure switch with manual reset, locks on pressure fall					
DG 10NT	0.4" to 4" WC	2 x 1/4" NPT	C6097A1095	84447962	116.00
DG 50NT	1.0" to 20" WC	2 x 1/4" NPT	C6097A1012	84447972	116.00
DG 150NT	12" to 60" WC	2 x 1/4" NPT	C6097A1038	84447982	116.00
DG 500NT	40" to 200" WC	2 x 1/4" NPT	C6097A1111	84447992	116.00



Look for the for in stock models normally available to ship within 24 hours.

Honeywell

L404F Pressuretrol® Controllers

Operating control with automatic limit protection for pressure systems. Use with steam, air, noncombustible gases, or fluids non-corrosive to pressure sensing element

Switching Action: SPDT snap-action switch to open or close a circuit on pressure rise

Connections: Pipe (main or high pressure): 1/4" NPT internal thread; Electrical: Screw terminals

Model Selection Guide

Operating Pressure	Sustained Pressure	Adjustable Differential	Sensor Element	Unit Includes	Catalog Number	Price
2 to 15 PSI	25 PSI max.	2 to 6 PSI	Stainless Steel Diaphragm	Siphon Loop	L404F1060	\$228.31
5 to 50 PSI	85 PSI max.	6 to 14 PS	Stainless Steel Diaphragm	Ground Screw	L404F1375	231.91
10 to 150 PSI	225 PSI max.	10 to 22 PSI	Stainless Steel Diaphragm	—	L404F1102	250.78



SER

- Single ended radiant tube fuel-efficient natural gas burner with low NOx emissions
- Compact design combines burner and upgraded recuperator coaxially mounted in the radiant tube for easy installation
- Dual finned combustor creates increased heat transfer surface and fuel savings
- Turndown: 10:1
- Maximum process temperature: 1850° F
- Exceptional heat flux and temperature uniformity
- Applications: indirect fired furnaces, tempering, hardening, continuous lines, annealing, galvanizing
- Three sizes available: 4.5", 6", and 8"
- Capacity range: 0.1 to 0.3 MMBtu/hr; 29 to 88 kW



Honeywell
ECLIPSE

CROSSFIRE®

- Nozzle-mixing line burner for use with low pressure natural gas firing
- Temperature uniformity enhances product quality
- Extremely low emissions — Capable of NOx levels of 25ppm and CO levels of 250ppm at 3% O2
- Also available in stainless steel housings or nickel-plated body
- Up to 2.5 MMBtu/h per foot; Up to 25:1 turndown



Honeywell
MAXON

UNI-RAD®

- Radiant tube burner for fuel gas inputs
- Suitable for use on pressure tubes, negative pressure tubes, and electrified radiant tubes
- Flame length adjustable by changing combustion air-to-ignition ratios — produces optimum tube temperature uniformity over a wide range of firing rates and preheated air temperatures
- Continuous plasma spark provides instantaneous ignition, so burner can operate from the DAT output of a PID control loop
- Can be used in conjunction with UV flame supervision equipment
- Capacity range: 0.08 to 0.7 MMBTU/hr



Honeywell
MAXON

RHT

- Completely packaged system that includes the heat exchanger, combustion chamber, burner, combustion air blower and gas train
- Ideal for applications that need the combustion items to be cut off from the process air section
- Process temperatures up to 550° F
- High temperature limit protection
- Free-floating design allows for expansion when heating up
- High efficiencies of 60-70%
- Meets NFPA 86 recommendations
- Outputs ranging from 0.17MMBTU/hr to 2.73MM BTU/hr



Honeywell
ECLIPSE

APX®

- Nozzle-mixing line burner for use with low pressure natural gas, propane and butane
- Single-piece aluminum extrusion body design eliminates leakage
- Cooler oven walls due to deeper penetration inside the oven (wall-mount); Independent of variable process air flows (in-duct)
- Corrosion-resistant main gas/air body and durable stainless steel mixing plates
- Packaged units up to 15 foot in length
- Up to 1.0 MMBtu/h per foot; Up to 40:1 turndown



Honeywell
MAXON

TUBE-O-FLAME®

- Nozzle-mixing refractory-less burners for tube firing of clean low-pressure fuel gas
- Increases heat transfer efficiencies with long swirling flame pattern
- Flange-mounted compact design for easy installation
- Low horsepower requirements reduce initial and operating costs
- Low NOx emissions
- Generates less noise than open-port tube firing
- Capacities to 5 MMBtu/h; Up to 20:1 turndown



Honeywell
MAXON

TUBE-O-THERM®

- Burns natural gas, propane, or butane
- UV flame scanner capability for all four sizes
- Burner-to-tube direct firing system for uniform heat transfer eliminates hot spots, and produces faster bring-up times in small-bore immersion tubes
- Designed with integral low-horsepower blower to lower costs and save energy
- Wall- or tube-mount design for no-hassle installation and easy maintenance access
- Capacities to 5.3 MMBtu/h



Honeywell
MAXON

NP-LE AIRFLO®

- Designed for direct-fired make-up air and process applications
- Designed for CO, NO2 emissions
- Shorter flame length
- Available in low pressure version and corrosion-resistant materials
- Easily meets ANSI/CSA standards
- Up to 1 MMBtu/h per foot; Up to 30:1 turndown

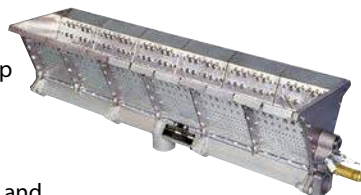

Honeywell
MAXON



OVENPAK® 400

- Burns any clean fuel gas; Requires only low-pressure gas
- Fires into passing air streams
- Provides clean combustion with low NOx levels
- Simple field adjustment and maintenance
- Compact burner design provides quick and easy installation
- More than 90 different styles and sizes including external blower versions
- Capacities to 16.5 MMBtu/h; Greater than 40:1 turndown



Honeywell



OVENPAK® LE

- Burns any clean fuel gas, and operates on low gas supply pressures
- Provides clean combustion with low NOx and CO levels
- Compact burner design provides quick and easy installation
- Balanced pressure design and visible ignition action for easy commissioning, adjustment and maintenance
- Up to 6.5 MMBtu/h; Up to 100:1 turndown

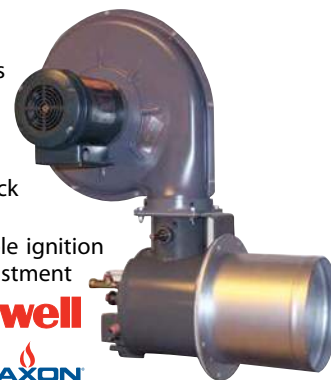

Honeywell



RatioMatic

- Low NOx, CO, and aldehyde emissions nozzle-mixing burner for natural gas, propane, and butane
- Regulator automatically compensates for changes in operating conditions that could upset the air/gas ratio
- Direct-drive air butterfly eliminates linkages that can slip or jam during operation
- Maximum process temperature 1900° F
- Applications including dry-off and curing ovens, incinerators, indirect air heating, textile drying, food processing and baking, annealing, and aluminum homogenization
- 21:1 to 100:1 turndown ratio
- Capacity 0.5 to 30 MMBtu/Hr (147 to 8785 kW)



Honeywell



KINEDIZER® LE

- Burns natural gas, propane, or other fuel gases
- Accepts preheated and vitiated combustion air
- Field-proven low emissions; State-of-the-art NOx firing, adjustable for application flexibility
- Rugged design for oxidizers, process heaters, kilns, furnaces, dryers, waste incineration, and other high-temperature applications
- Excellent stirring and mixing with medium velocity exhaust
- Six sizes, capacities up to 75 MMBtu/h; Up to 22:1 turndown



Honeywell



KINEMAX®

- Burns most clean low-pressure gaseous fuels or light oil; Can be used with oxygen-enriched combustion air
- Lower fuel consumption using preheated combustion air (up to 800°F)
- Operate on-ratio with excess fuel or excess oil to meet specific process demands
- Exit velocities up to 275 ft/s to promote workload heat penetration and better furnace temperature uniformity
- Refractory block for chamber temperatures up to 3000°F
- Removable backplate gives easy access for inspection, maintenance
- Seven sizes, capacities to 8.4 MMBtu/h; Up to 48:1 turndown



Honeywell



M-PAKT®

- Burns natural gas or propane
- Extremely low emissions — Capable of single-digit NOx and CO levels at 3% O2
- Flame contained almost entirely inside the discharge sleeve
- Durable steel outer construction with stainless steel internals
- Up to 8.4 MMBtu/h; Up to 13.5:1 turndown

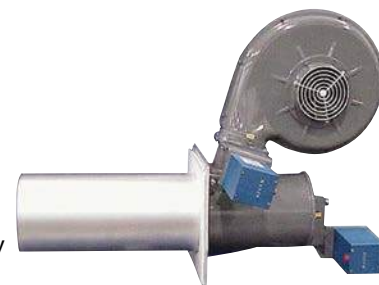

Honeywell



ThermJet

- Nozzle mixing burner for natural gas, propane and butane
- Available in high velocity (500 ft/sec) and medium velocity (250 ft/sec)
- Fires an intense stream of hot gases through a combustor using ambient combustion air
- 50:1 turndown ratio
- Maximum process temperature 2800F
- Easy setup with built-in metering
- Applications include tempering, reheating, and hardening furnaces, fluidized bed dryers, thermal oxidizers, non-ferrous melting, preheated air, and environmental applications
- Capacity 0.15 to 20 MMBtu/Hr (44 to 5860 kW)



Honeywell



OPTIMA™ SLS

- Fuel flexible with natural gas, propane, and butane capability
- Low NOx and CO production levels for extremely clean, reliable heat — and easy air permitting and environmental compliance
- Large capacity heat releases with a compact, robust flame geometry
- Intelligent ratio control provides reliable operation and optimal fuel efficiency
- All steel and high temperature alloy construction for reduced weight, increased durability
- Configurable for dryers, air heaters, ovens, kilns, process heaters, paper machines, and a variety of industrial heating equipment
- Compatible with SMARTFIRE® control and communication gateway
- Five sizes, capacities to 93.5 MMBtu/h; Up to 17.8:1 turndown



Honeywell



Honeywell SMJ Centrifugal High Efficiency Blower



The Eclipse SMJ blower is an adaptable blower that provides low pressure air for industrial combustion systems in applications where air temperatures are under 220° F.

The SMJ blower comes with aluminum impellers that are both statically and dynamically balanced and an improved fan housing that lets you change the direction of the fan's rotation in the field. Additionally, the outlet couplings have been replaced with flanges to make installation easier.

- Capacity range: 4,800 to 210,000 SCFH
- Pressure: 7 to 60 outlet "WC
- Four outlet positions that can be changed easily by remounting
- Heavy-gauge steel base and housing
- Typical applications: industrial combustion, cooling, conveying drying, liquid agitation, smoke abatement, and fume exhausting



SMJ shown with round air inlet filter.

Model Selection Guide

Outlet Size	Motor	"WC	SCFH	Catalog Number	Price
3"	3/4 HP	14.0	10,000	SMJ 3414	\$2861.00
3"	2 HP	28.2	10,500	SMJ 3619	3431.00
4"	3/4 HP	10.0	14,000	SMJ 4412	2720.00
4"	1/2 HP	7.0	15,000	SMJ 4610	2174.00
4"	1 HP	14.5	12,200	SMJ 4614	3115.00
4"	1 HP	17.0	15,300	SMJ 4615	3079.00
4"	1.5 HP	18.0	23,000	SMJ 4616	3236.00
4"	1.5 HP	20.0	15,000	SMJ 4617	3616.00
4"	2 HP	28.7	12,250	SMJ 4619	3449.00
6"	2 HP	13.0	31,500	SMJ 6614	3438.00
6"	2 HP	15.6	25,000	SMJ 6615	3473.00
6"	3 HP	20.2	32,000	SMJ 6617	3786.00
6"	5 HP	28.2	41,200	SMJ 6619	4354.00

Outlet Size	Motor	"WC	SCFH	Catalog Number	Price
6"	2 HP	10.0	45,000	SMJ 6812	\$3511.00
8"	3 HP	12.0	58,000	SMJ 8813	5012.00
8"	3 HP	13.5	52,500	SMJ 8814	3761.00
8"	5 HP	13.5	75,000	SMJ 8815	3959.00
8"	5 HP	17.0	70,000	SMJ 8816	4378.00
8"	7.5 HP	20.0	85,000	SMJ 8817	5026.00
8"	7.5 HP	28.2	57,000	SMJ 8819	4924.00
10"	7.5 HP	17.0	86,000	SMJ 101016	6769.00
Round air inlet filter					
Up to 25,000 SCFH				25 FAJ	571.00
Up to 50,000 SCFH				50 FAJ	849.00
Up to 150,000 SCFH				150 FAJ	1340.00

Call for blowers with other capacities.



HAUCK TBA Turbo Blower

The HAUCK direct drive Turbo Blower was designed to generate efficiencies of up to 50% over conventional blowers. The Turbo Blower meets air volume and pressure requirements with smaller horsepower to reduce overall power consumption. It is available in six pressure ranges from 12–36 osig (5.2—15.5 kPa) and 63 different sizes ranging from 240 to 13,000 scfm (6.4—348 nm³/min) for providing large or small volumes of air at constant pressures. The Turbo Blower is designed to supply air for combustion or for any low pressure air application, and is corrosion resistant for longer life.

- Integral molded scroll design
- Turbine bladed impeller
- Steel inlet guard
- Precisely balanced impellers eliminate vibration
- Complete line of available accessories for adapting to any piping condition or operational requirement
- More abrasion resistant than steel blower housing

Call for pricing and availability.

Learn More About Combustion Controls, Flame Safety, and Emissions Testing and Analysis

Visit Lesman Training Center at www.lesman.com/train/ to watch recorded sessions of webinars about flame safety, fuel air ratio control, fuel train basics, and emissions and combustion testing.





Honeywell



- For all clean industrial gases
- Capacity: 16mm (0.63"): 2800–4800 BTU/Hr; 25mm (0.98"): 4000–11500 BTU/Hr
- One electrode for ignition and control

ZMI Ionization Pilot for Industrial Gas Burners

For automatic ignition and control of clean industrial gas burners. Compatible with Kromschroder IFS automatic burner controls, PFU760 and PFU780 burner controls, TZI and TGI ignition transformers.

Construction: Flame tube: 25 CR/20Ni; Housing: Aluminum; Electrode: Kanthal; Burner head: Ceramic

Ambient Temperature: 183° F max

Connections: Gas: 1/4" NPT; Air: 1/2" NPT

Pressure Range (Gas and Air): 4" to 20" WC (10 to 50 bar)

Model Selection Guide

Capacity	Burner Size	Tube Length	Catalog Number	Price
2800-4800 BTU/Hr	0.63"	5.9"	84230015	\$360.00
	0.63"	7.87"	84230025	360.00
	0.63"	11.81"	84230035	415.00
	0.63"	15.75"	84230045	468.00
	0.63"	19.69"	84230055	521.00
4000-11500 BTU/Hr	0.63"	23.62"	84230065	575.00
	0.98"	5.9"	84234015	478.00
	0.98"	7.87"	84234025	478.00
	0.98"	11.81"	84234035	537.00
	0.98"	15.75"	84234045	596.00
	0.98"	19.69"	84234055	655.00
	0.98"	23.62"	84234065	714.00

Honeywell



ZAI Ionization Pilot for Natural Gas Burners

For the safe ignition and flame protection of atmospheric burners. Compatible with Kromschroder IFS automatic burner controls, PFU760 and PFU780 burner controls.

- Capacity 3kW (approximately 2500 kCal/Hr)
- Direct ignition and ionization control
- Pilot burner with forced air supply

Construction: Ignition head and fixing plate: Galvanized steel; Ignition and ionization electrodes: Kanthal A-1; Plug connector: Brown (suppressed) for ignition electrode, black for flame rectification electrode

Ambient Temperature: 572° F max

Gas Connection: Cu-tube 8x1

Protective Grade: IP20

Model Selection Guide

Description	Catalog Number	Price
ZAI Ionization Pilot Burner	84228020	\$119.00
Heat-Resistant Protective Tube	35437010	84.00

Honeywell



ZKIH Ionization Pilot for Direct Ignition Burners

For the safe ignition and ionization control of gas burners. Compatible with Kromschroder IFS automatic burner controls and PF-19 burner control systems.

- Capacity 2–7kW
- Pilot burner with forced air supply
- Direct ignition and ionization control
- For natural gas, town gas, and LPG

Temperature: Ambient at flame conduit tube: 1832°F max; Ambient around burner nozzle: 932°F max; Gas/air temperature: 338°F max

Connections: Gas: 1/4" NPT; Air: 1/2" NPT

Orifice Insert: 0.09" diameter

Construction: Housing: AlSi; Ignition/sensing electrodes: Kanthal A-1; Flame conduit/protection tubes: Heat-proof Cr-Ni steel

Pressure: Gas: 8" WC; Air: 16" WC

Flow Rate: Gas: 14 ft³/hr; Air: 140 ft³/hr

Model Selection Guide

	Burner Size	Tube Length	Catalog Number	Price
ZKIH Pilot Burner	5.9"	3.94"	84214010	\$384.00
	7.87"	3.94"	84214020	384.00
	11.81"	3.94"	84214030	456.00
	15.75"	3.94"	84214040	531.00
NPT Adapter Set for ZKIH Burner			74923430	49.20

WIKAI® 213.53 Liquid-Filled Stainless Steel Industrial Gauges

WIKAI 213.53 gauges feature a stainless steel case for protection in harsh environments. They are ideal for high vibration and pulsation applications.

Specifications

Accuracy: ±2-1-2% span

Working Temperature: Ambient: -40° to 140°F dry or silicone filled; -4° to 140°F Glycerine filled; Media temperature: 140°F max.

Case: 304 stainless steel

Wetted Parts: Copper alloy

Window: Polycarbonate





Dial: White ABS with black aluminum non-adjustable pointer; Single scale has PSI in black, dual scale has PSI values outside in black, BAR values inside in red.

Bezel Ring: Crimp-on stainless steel

Case-to-Socket O-ring: Dry or Silicone-filled: Viton; Glycerine-filled: EPDM

Standard Fill Fluid: Glycerine

Model Selection Guide

Mount	Pressure Range	Dial Size	Catalog Number	Price Each
	Type 213.53, Single Scale (PSI), 1/4" NPT Bottom Connection			
	30" Hg	2.5"	9767002	\$24.57
	30"-0-30 PSI	2.5"	9767010	24.57
	0-15 PSI	2.5"	 9767037	23.56
	0-30 PSI	2.5"	 9767045	23.56
	Type 213.53, Single Scale (PSI), 1/4" NPT Center Back Mount			
	30" Hg	2.5"	9767185	\$25.58
	0-30 PSI	2.5"	9767193	24.57



Call for dual scale models, Buna-N O-ring, or silicone fill.

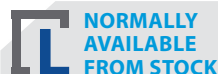

Look for the  for in stock models normally available to ship within 24 hours.

Honeywell

Q624A1014 Gas Ignition Transformer

Used to ignite pilots on commercial or industrial gas burners. For interrupted ignition applications only.

- Ignite gas pilots with spark gaps up to 1/4"
- Reliable light off with 15,000 peak voltage
- Prevent detection of the ignition spark when properly applied in a flame detection system with the C7027, C7035 or C7044 Minipeeper ultraviolet flame detector. (See page 10.)
- Mount in same space used by conventional ignition transformer, but less than half the weight
- UL Recognized, CSA Certified

Model Selection Guide

Description	Catalog Number	Price
Gas Ignition Transformer	 Q624A1014	\$240.42
24" Ignition Cable	32004766-001	15.19
60" Ignition Cable	32004766-004	15.07
120" Ignition Cable	32004766-002	12.08



Honeywell

S8610U3009 Intermittent Pilot Ignition Control

Provides ignition sequence, flame monitoring, and safety shutoff for intermittent pilot ignition systems used on natural or LP gas-fired furnaces, boilers, and heating applications.

Electrical Rating: 24 V, 60 Hz; **Current Draw:** 1A pilot valve, 2A main valve; **Contact Rating:** 0.2A

Field Replacement:

For most Honeywell, Robertshaw, Johnson, UTEC (HCS) intermittent pilot ignition modules



Model Selection Guide

Description	Catalog Number	Price
Intermittent pilot control. 15- or 90-sec trial for ignition, 0- or 30-sec configurable pre-purge	 S8610U3009	\$210.60





Honeywell UDC 2500 Digital Loop and Limit Controllers

The 1/4 DIN UDC2500 monitors and controls temperatures and other variables in applications such as furnaces and ovens, environmental chambers, packaging machinery, plastic processing machines.

- Up to 2 analog inputs (1 universal and 1 high level)
- Up to 2 analog outputs
- Up to 4 digital outputs
- Up to 2 digital inputs
- NEMA 4X, IP68 front face
- PC-based Process Instrument Explorer configuration tool
- FM-approved limit controller model
- Universal input/output model
- Thermocouple health monitoring
- AccuTune III (Fast/Slow, Heat/Cool)

Get full specs and learn more at bit.ly/udc2500



Want to Know How Your Thermocouples Are Performing?

Thermocouples fail. It's a fact you deal with every day. But when they fail without any warning, you're stuck dealing with a slew of costly problems!

Your furnace or oven shuts down.

You run the risk of destroying entire batches.

You waste energy reheating product after the failed thermocouples are replaced.

You can choose to replace your thermocouples on a scheduled basis, but that's not always the best answer. It's expensive, labor-intensive, and not always necessary.

You get four different levels of alarm: Good, Failing, Failure Imminent, and Failed (Burn-out), so you can replace the temperature sensors before they fail, and save yourself the time, money, and hassle!

Model Selection Guide

Choose one item from each section below to build your UDC2500 controller. A complete part number looks like this: DC2500-C0-0000-20000000-E0-0

Description	Catalog Number	Price
Power	1/4 DIN Digital Controller for 90-264 VAC Power	DC2500- \$519.00
Output #1	Current Output — 0/4-20 mA	C _- 41.00
	5 Amp Form C Electromechanical Relay	E _- 0.00
	1 Amp Solid State Relay	A _- 0.00
	None	_ 0- 0.00
Output #2 and Alarm #1	One Alarm Relay Only (5 Amp Form C)	_ B- 41.00
	Electromechanical Relay and Alarm #1	_ E- 83.00
	Solid State Relay and Alarm #1	_ A- 83.00
Communications	None	0 _ _ - 0.00
	1 Auxiliary Output and 1 or 2 Digital Inputs	1 _ _ - 150.00
Software	Standard Functions, Single Display	_ 000- 0.00
	Dual Display with Auto/Manual	_ A00- 36.00
	Setpoint Programming, Dual Display, and Auto/Manual	_ B00- 127.00
	Limit Controller (Includes Dual Display)	_ L00- 18.00
Input #1	Thermocouple, RTD, mV, 0-5 V, 1-5 V, 0-20 mA, 4-20 mA	200 - 0.00
Approvals	CE, UL, CSA (Standard)	00000- 0.00
	CE, UL, CSA, and FM	10000- 41.00
Documentation	Printed English User Manual	E0-0 34.00

Popular configurations available from Lesman stock.

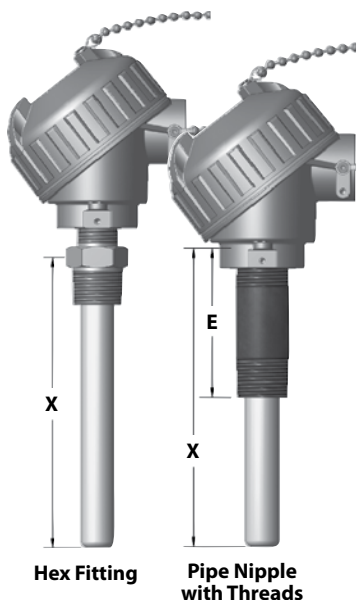

Thermocouple Assemblies with Ceramic Protection Tubes

Model Selection Guide

Make one selection from each table section. Replace the X in the catalog number with your desired tube length, and the (e) in the catalog number with your desired pipe nipple length. Example: K8R-16CH-18-34,8

Protection Tube	Tube OD	NPT	Catalog Number	Tube Length (X)				
				12	18	24	30	36
Type K Thermocouple, 8 Gauge Element								
Mullite Tube, Steel Hex Fitting	3/4"	3/4"	K8R-16CH-X-	\$96.40	\$110.00	\$123.60	\$137.20	\$150.80
Mullite Tube, Steel Hex Fitting	7/8"	1"	K8R-16WH-X	100.20	115.40	130.60	145.80	161.00
Mullite Tube, Steel Pipe Nipple	3/4"	3/4"	K8R-16C(e)-X-	91.60	105.20	118.80	132.40	146.00
Head Termination	Aluminum Screw Cover Head		31	0.00				
	Cast Iron Screw Cover Head		34	0.00				
Assembly Options	316SS Hex Fitting (for CH Models)		,8	44.00				
	316SS Hex Fitting (for WH Models)		,8	100.00				

Need a Type R, S, or B thermocouple instead? Call for current pricing and delivery.

Honeywell GDJ Spring-Loaded Gas Pressure Regulator



Kromschroder's GDJ gas pressure regulator is used for controlling gas pressure of furnace ovens and other gas-consuming appliances that burn natural gas, LP gas, or clean biogases (methane, H₂S 0.02%/vol max.). The GDJ can also be used for air. The spring-loaded regulator in inlet pressure compensation diaphragm and zero shutoff maintains the set outlet pressure constant, even with changing flow rates and inlet pressures in gas pipelines.

An additional safety diaphragm eliminates the need for a breather line. The GDJ can be installed with its spring dome pointing vertically upward to the side, but not upside down. To comply with EN 746-2, a safety shutoff valve, like the Kromschroder JSAV, must be installed upstream of the GDJ gas pressure regulator.

- Universal pressure regulator for gas
- 5 PSIG maximum inlet pressure
- 10:1 control range
- Aluminum valve housing and seat, plastic valve disc, Perbunan disc seal and diaphragms
- CSA approved, CE tested and certified

Model Selection Guide

Model Number	Regulator Size	Outlet Pressure Range	Catalog Number	Price
GDJ 15TN04-0	1/2"	16-22 "WC	03155081	\$138.00
GDJ 20TN04-0	3/4"	28-40 "WC	03155082	162.00
GDJ 25TN04-0	1"	28-40 "WC	03155083	168.00
GDJ 40TN04-0	1-1/2"	28-40 "WC	03155084	305.00
GDJ 50TN04-0	2"	28-40 "WC	03155085	439.00
Flow limiter			03089220	16.70

Get full specs and learn more at bit.ly/gdj-regulator



600 Series Two-Piece Brass Manual Ball Valve

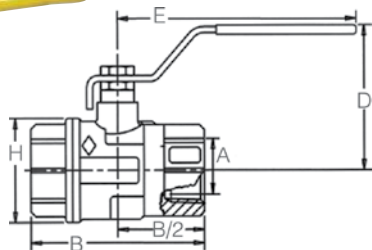

- Brass body, ball, blowout-proof stem, Teflon packing and seats
- Full port configuration, NPT female threaded ends
- Pressure rating: 600 PSI WOG, WSP 150 PSI steam
- Temperature range: -40° to 366° F

Get full specs and learn more at bit.ly/marwin-600

Model Selection Guide

Valve Size	Cv	Dimensions					Catalog Number	Price
		A	B	D	E	H		
1/4"	6.3	0.39"	2.02"	1.7"	3.9"	0.9"	666FTTS-025	\$ 10.12
3/8"	7.0	0.39"	2.02"	1.7"	3.9"	0.9"	666FTTS-038	14.72
1/2"	19.0	0.59"	2.44"	1.8"	3.9"	1.25"	666FTTS-050	16.56
3/4"	34.4	0.79"	2.71"	2.3"	4.8"	1.53"	666FTTS-075	23.00
1"	50.0	0.98"	3.07"	2.4"	4.8"	1.92"	666FTTS-100	34.96
1-1/4"	104.0	1.26"	3.42"	3"	6"	2.32"	666FTTS-125	59.80
1-1/2"	268.0	1.57"	3.89"	3.2"	6"	2.87"	666FTTS-150	88.32
2"	309.0	1.95"	4.33"	3.7"	6.4"	3.38"	666FTTS-200	122.36
2-1/2"	629.0	2.4"	5.59"	4.8"	8.1"	4.37"	666FTTS-250	205.16
3"	1018.0	2.87"	6.45"	5.2"	8.1"	5.35"	666FTTS-300	328.44
4"	1622.0	3.82"	7.6"	6.5"	10.2"	6.35"	666FTTS-400	488.52

Also available with locking lever.



Titan YS12-CI Cast Iron Y-Type Strainers

Y-type strainers filter debris from pipelines to protect equipment downstream such as pumps, meters, spray nozzles, compressors, and turbines. They can be installed in vertical or horizontal applications as long as the screen is in a downward position. The size of the perforations in the straining element is determined by the smallest particle that needs to be removed.

- Sizes: 1/4" to 3"
- WOG (Non-shock) @ 150° F: 400 PSI
- ANSI Class 250
- Stainless steel straining element
- Lead free, cast iron body, epoxy-painted to resist corrosion

Call 800-953-7626 for pricing and availability.





Testo 350 Portable Combustion Efficiency Analyzer

- Test up to six gases simultaneously, or swap sensors out for additional parameters (NO_{low}, CO_{low}, SO₂, H₂s, Co₂, C_xH_y)
- Innovative dilution systems for the widest testing ranges and greatest sensor protection (CO to 400,000 ppm, SO, NO₂, SO₂, H₂S to five times the sensor range)
- Integrated pressure measurement for draft, differential pressure, velocity, and mass emission
- Comprehensive calculations including O₂ corrections for NO_x, CO, and SO₂, mass measurement with pitot and stack dimension output
- Advanced sample conditioning uses a thermoelectric chiller for moisture drop-out and a peristaltic hose pump for controlled water removal
- Proven sample gas path with Teflon-lined hoses and continuous temperature compensation for assured accuracy
- Flow rate and sensor temperature monitoring for US EPA CTM-030, 034, and ASTM D6522 requirements; User-defined O₂ references for US EPA and state reporting
- User-defined programs with onboard memory to 250,000 values



Models and Accessories for Sale

■ = Standard Kit Item (No added charge) (Add ♦ and ○ as Separate Line Items)

♦ = No-Cost Option ○ = Upgrade and Add to Total Price

Description	Catalog Number	Availability			Price
350 Boiler and Burner Kit	400563 3512				\$10795.00
350 Engine Testing Kit	400563 3513	↓	↓	↓	11950.00
350 Turbine Testing Kit	400563 3514			↓	12895.00
13" Sampling Probe, 7' Hose (932° F Max.)	0600 9766	■	○	○	595.00
13" Engine Probe, 7' hose (1832° F Max)	0600 8764	○	■	■	950.00
9' Hose Extension (Max Allowable 25')	0554 1202	○	○	○	249.00
Maximum Number of Sensors Allowable		6	6	6	
O ₂ (0-25%)	0393 0000	■	■	■	259.00
CO (0-10000 ppm)	0554 2104	■	■	○	1680.00
CO low (0-500 ppm)	0554 2102	○	○	■	1680.00
CO ₂ NDIR (0-50%)	0554 2400	○	○	○	3995.00
H ₂ S (0-300 ppm)	0554 2350	○	○	○	1995.00
NO (0-3000 ppm)	0554 2150	■	■	○	1680.00
NO low (0-300 ppm)	0554 2152	○	○	■	1680.00
NO ₂ (0-500 ppm)	0554 2200	■	■	■	1680.00
SO ₂ (0-5000 ppm)	0554 2250	○	○	○	1680.00
C _x H _y (0-4% hydrocarbons)	0554 2300	○	○	○	1880.00
Dilution system upgrade (requires fresh air valve)	0450 3555	○	■	■	1302.00
Fresh air valve	Call	○	■	■	392.00
6' Data Bus Cable	0449 0075	■	■	■	159.00
16' Data Bus Cable	0449 0076	○	○	○	239.00
39" Probe (2200° F), 13' Lined Hose	400600 7803	○	○	○	839.00
Bluetooth Fast Printer (300' Range)	0554 0620	○	○	○	479.00
Infrared Printer	0554 0549	○	○	○	319.00
Thermal Paper, 6 Rolls (10-Year Legibility)	0554 0568	○	○	○	35.00
Rugged Pelican Case with Foam Insertion	400516 3515	○	○	○	782.00

Replacement Sensor Modules

O ₂ (0-25%)	0393 0000	○	○	○	259.00
CO-H ₂ (0-10000 ppm)	0393 0104	○	○	○	695.00
CO low (0-500 ppm)	0393 0102	○	○	○	695.00
CO ₂ (NDIR 0-50% vol%)	0393 0400	○	○	○	3999.00
H ₂ S (0-300 ppm)	0393 0350	○	○	○	749.00
NO (0-3000 ppm)	0393 0150	○	○	○	695.00
NO low (0-300 ppm)	0393 0152	○	○	○	695.00
NO ₂ (0-500 ppm)	0393 0200	○	○	○	695.00
SO ₂ (0-5000 ppm)	0393 0250	○	○	○	695.00
C _x H _y (0-4% hydrocarbons)	0393 0300	○	○	○	739.00

Testo 350 analyzers are available for rent for short-term projects. Order online at RaecoRents.com or call 866-736-8347.

All systems include: Control unit and analyzer box, Bluetooth 2.0 communications, internal memory to 250,000 readings, advanced sensor temperature compensation, multiple temperature measurement (stack, sensor, ambient), sample flow rate monitoring (EPA compliant), auto CO overrange protection, thermoelectric sample conditioner with condensate removal pump, fresh air valve for automatic programs and long-term testing, differential pressure measurement, USB connection, AC power cable, extra particle filters, 6' data bus communications cable, easyEmissions software, standard carrying case, and calibration certificate.



Due to contract restrictions, Testo instruments are only available for sale within our Midwest regional territory (though parts are available for unrestricted sale). They can be rented anywhere within the US through our partners at RaecoRents.com.

Honeywell

THE POWER OF CONNECTED



XXN Universal Gas Detection Transmitter

Features

- Supports mV (catalytic bead or IR), electrochemical cell and IR (point and open-path) gas detection
- 4-20 mA with HART® standard; Options include up to 3 relays, MODBUS® and FOUNDATION® H1 Fieldbus; Optional local IS port for handheld HART configurator
- Large, backlit, easy-to-view LCD display offers visual icons, colored buttons, and text to display gas and sensor readings
- Self-test and fault indication features; Quick calibration
- Robust and reliable operation in harsh environments

XXN is designed for flexible integration, simple installation, user friendly operation and straightforward maintenance. A powerful advanced communications module adds increased functionality and flexibility to a gas detection network. Standard HART communications, along with optional Modbus, Foundation Fieldbus or relays, interface with a PLC.

The XXN enclosure is available in a painted stainless steel or aluminum housing with a marine grade coating. Rugged mounting options provide ultimate installation flexibility. Sensor instrumentation can be attached locally to the transmitter or remotely with the appropriate accessories. Inside, customer and sensor connections to the unit are designed to protect against dangerous electrical misconnections. With approvals to UL, CSA and ATEX requirements for Hazardous Locations, and IP66/67 rating to protect against dirt/water ingress, the XXN serves the most demanding industrial environments.

Condensed Specifications

Enclosure: Painted aluminum or 316 stainless steel, five conduit/cable entries; NEMA 4X/IP65 rated

Interface: Backlit 2.5" tall LCD high resolution dot matrix display with discrete alarm and status indication; Reliable non-intrusive four-button interface with magnetic wand access. HART handheld with IS port optional

Display: Gas reading, gas name and engineering units, fault and alarm status, large numeric concentration or LEL display, bargraph showing current reading, setpoints and full scale; Fault/alarm and operating status indication; Security settings allow multi-level operator access for setup, configuration and calibration; Event history stores time and date of all alarm, diagnostic, and configuration events

Output Signal: Standard HART over three-wire, 4-20 mA. Optional Form C and three 5A SPDT relays (two alarm, one fault); Modbus over RS-485 and Foundation Fieldbus (not available with relays)

Approvals: *Hazardous Area:* UL: Class I, Div 1, Groups B-D, Class 1, Zone 1, AEx d IIC T5; CSA: Class I, Div 1, Groups B-D, T5; *Performance:* UL 913, UL 1203, CSA 22.2 #152 pending; SIL 2



HART® Handheld Communicator

Fast startup, long battery life on standard batteries. Holds hundreds of device files and configurations! Download DOF and firmware updates from www.Meriam.com.

General Service HART Communicator	MFC5150	\$5300.00
Intrinsically Safe HART Communicator	MFC5150X	5750.00

Honeywell XNX Series Gas Sensors and Ranges

Gas Type	Range
Acetylene IR	0-2.5%
Ammonia	0-100 ppm 0-1000 ppm
Arsine	0-2 ppm
Bromine	0-5 ppm
Carbon Dioxide IR	0-5000 ppm
Carbon Dioxide	0-2% 0-5%
Carbon Monoxide	0-100 ppm 0-500 ppm 0-1000 ppm
Chlorine	0-5 ppm 0-10 ppm 0-20 ppm
Chlorine Dioxide	0-3 ppm
Diborane	0-50 ppm
Ethylene Oxide	0-10 ppm
Fluorine	0-5 ppm
Germane	0-3 ppm
Hydrogen	0-1000 ppm
Hydrogen Cyanide	0-50 ppm
Hydrogen Chloride	0-50 ppm
Hydrogen Fluoride	0-10 ppm
Hydrogen Sulfide	0-10 ppm 0-50 ppm 0-100 ppm 0-500 ppm
Hydrogen Sulfide	Solid State
Nitric Oxide	0-100 ppm
Nitrogen Dioxide	0-10 ppm
Oxygen	0-10% 0-25%
Phosphine	0-2 ppm
Silane	0-25 ppm
Sulfur Dioxide	0-25 ppm 0-100 ppm
Combustible Gases (0-100% LEL)	
Natural Gas & H2	
Petroleum Vapors	
Solvents	
IR for Methane	
IR for Propane	
ATEX 4.4% CH4, Natural Gas & H2	
ATEX 1.7% Propane Petroleum Vapors	
ATEX 1.7% Propane Solvents	
IR Methane, ATEX 4.4% CH4	
IR Non-Methane, ATEX 1.7% Propane	
Oxygen	
Solvent-Tolerant	
Solvent/CO2-Tolerant	
Low	
Low, Solvent-Tolerant	

Universal Gas Detection HART Transmitters



A complete XNX model consists of the following:

- 1 An XNX transmitter base station
- 2 Your choice of electrochemical cell, infrared, or mV sensors

Start with your XNX-UT model, and then add the necessary number of sensors as individual line items. **Example:** XNX-UTAE-RHNNN with one each XNXXSC1SS and XNXXSS1SS sensors.

Model Selection Guide

Description		Catalog No.	Availability	Price
UL Approved XNX Transmitter Base Station		XNX-UT__-	• • •	\$0.00
Enclosure	Aluminum, 3/4" NPT threads	__A_-	• • •	152.00
	316 SS, 3/4" NPT threads	__S_-	• • •	254.00
Sensor Type	Electrochemical cell	___E-	↓	920.00
	Infrared (combustible gas)	___I-	↓	576.00
	milliVolt	___V-	↓	576.00
	None	N_____	• • •	0.00
Output Interface	Relay	R_____	• • •	110.00
	Modbus	M_____	• • •	135.00
	Foundation Fieldbus	F_____		558.00
Local Interface	None	_NNNN	• • •	0.00
	Local HART® (requires handheld)	_HNNN	• • •	225.00
Spare Magnetic Wand/Screwdriver		1226-0254	• • •	9.00

If you picked sensor type E, select your electrochemical cell sensors below.

Description	Catalog No.	Availability	Price
Electrochemical cell (EC) toxic and oxygen sensors for XNX universal transmitter		↓	
Oxygen, 0–25% volume	XNXXSO1SS	•	\$447.00
Carbon Monoxide	XNXXSC1SS	•	447.00
Hydrogen Sulfide, 0-15/10-50 ppm	XNXXSH1SS	•	447.00
Hydrogen Sulfide, 0-100 ppm	XNXXSH2SS	•	447.00
Chlorine	XNXXSL1SS	•	559.00
Sulfur Dioxide, 0-15 ppm	XNXXSS1SS	•	559.00
Sulfur Dioxide, 0-50 ppm	XNXXSS2SS	•	559.00
Chlorine Dioxide	XNXXSX1SS	•	559.00
Hydrogen, 0–1000 ppm	XNXXSG1SS	•	559.00
Hydrogen, 0–10000 ppm	XNXXSG2SS	•	559.00
Phosphine	XNXXSP1SS	•	670.00

Accessories for EC sensors

XNX Remote EC Sensor Mount Kit	S3KRMK	•	506.00
Calibration Gas Flow Adapter Kit	S3KCAL	•	67.00

Replacement toxic and oxygen sensor cartridges for EC sensors

Oxygen, 0–25% volume	S3KO1SS	•	251.00
Carbon Monoxide	S3KC1SS	•	251.00
Hydrogen Sulfide, 0-15/10-50 ppm	S3KH1SS	•	251.00
Hydrogen Sulfide, 0-100 ppm	S3KH2SS	•	251.00
Chlorine	S3KL1SS	•	363.00
Sulfur Dioxide, 0-15 ppm	S3KS1SS	•	363.00
Chlorine Dioxide	S3KX1SS	•	363.00
Hydrogen, 0–1000 ppm	S3KG1SS	•	363.00
Hydrogen, 0–10000 ppm	S3KG2SS	•	363.00
Phosphine	S3KP1SS	•	447.00

XNX-AM █ █ █ █ █ █ █

Agency Approval	Port Threads	Enclosure	Sensor	Interface Option	Local HART®	Sensor and Range
ATEX - A	M25 - M	Stainless - S	Electrochem - E	None - N	None - N	None - NNN
UL / CSA - U	3/4" NPT - T	Aluminum - A	Infrared - I	Relay - R	Local HART® - H	MPD-AM (Catalytic Bead %LEL) - CB1
INMETRO - B			milliVolt - V	Modbus® - M		MPD-AMF1 (R %LEL Flamm) - IF1
				Foundation™ Fieldbus - F		MPD-AMV1 (R CH4 0-5% Vol) - IV1
						MPD-AMC1 (R CO 0-2% Vol) - IC1

If you picked sensor type I, select your infrared sensors below.

Description	Catalog No.	Availability	Price
-------------	-------------	--------------	-------

UL Approved Optima Plus Infrared Combustible Gas Detection Sensors: Configured as current source output, standard with dust barrier, weather housing, and deluge/heat shade

Hydrocarbon calibration	Standard	2108N4100N	•	\$1614.00
	With remote gassing cell	2108N4110N	•	1674.00
	With remote gassing cell and flow housing	2108N5100N	•	1885.00
Ethylene calibration	Standard	2108N4101N	•	1614.00
	With remote gassing cell	2108N4111N	•	1674.00
	With remote gassing cell and flow housing	2108N5101N	•	1885.00

Additional Non-Standard Calibrations for Optima Plus IR Combustible Gas Detection Sensors (100% LEL Unless Specified)	Acetone	2108D3012	•	185.00
	Band A High IR	2108D3150	•	185.00
	Band B High IR	2108D3151	•	185.00
	Band C Medium IR	2108D3152	•	185.00
	Band D Low IR	2108D3153	•	185.00
	Benzene	2108D3227	•	185.00
	Butanone (MEK)	2108D3023	•	97.00
	Di-Methyl Ether	2108D3059	•	97.00
	Ethyl Acetate	2108D3030	•	185.00
	Methane	2108D3001	•	0.00
Call for other calibrations.	Propane	2108D3004	•	0.00
	Propane, 60% V/V	2108D3102	•	97.00
	Propylene	2108D3006	•	185.00

Accessories for Optima Plus IR combustible gas sensors

Gassing Cover (for Bump Verification)	2108D0258	•	152.00
Calibration Cap	2108B0272	•	220.00
Universal Duct Mounting Kit	1283K2240	•	598.00
Right Angle Junction Box for Use with Universal Duct Mounting Kit	1283A2266	•	133.00

If you picked sensor type V, select your milliVolt sensors below.

Description	Catalog No.	Availability	Price
-------------	-------------	--------------	-------

Replace -NNN in the XNX model number with the code below.

MPD-AM Catalytic Bead, %LEL	CB1	•	\$629.00
MPD-AMF1 IR %LEL Flammable	IF1	•	850.00
MPD-AMV1 IR CH4 0-5% Volume	IV1	•	850.00
MPD-AMC1 R CO2 0-5% Volume	IC1	•	850.00

Replacement cartridges for MPD sensors

Catalytic Bead Cartridge, %LEL	1226A0359	•	322.00
IR Cartridge, %LEL Flammable	1226-0300	•	447.00
IR Cartridge, CH4 0-5% V/V	1226-0299	•	447.00
IR Cartridge, CO2 0-5% V/V	1226-0301	•	447.00

Lesman

INSTRUMENTS • VALVES • CONTROLS

135 Bernice Dr • Bensenville, IL 60106-3366

www.Lesman.com • 800-953-7626

Prices in this document are current at the publication date, and are subject to change without notice.

Due to manufacturer agreements, some products may not be available in all Lesman markets or geographic areas.

Help us stay green. Call us or send an email to mail_list@lesman.com, and let us know if this person is no longer with your company.

Custom Systems for Your Application

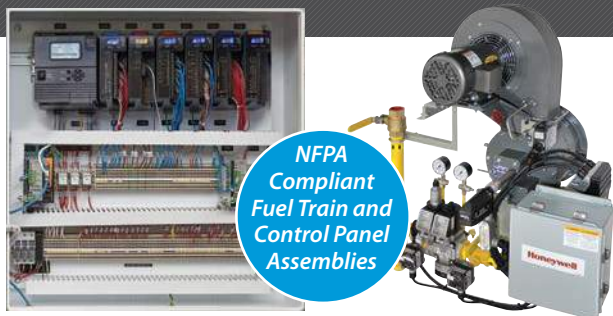

Reduce Downtime, Get Replacements Fast!



Look for the  for popular models normally available from Lesman stock, and ready to ship within 24 hours.

Order from our secure web store at Lesman.com.

Web orders of \$500 or more ship free UPS Ground.

Replacement Components | Upgrades or Retrofits | New Combustion Systems and Fuel Trains

Contact our factory-trained sales team at 800-953-7626.

Configurable Safety and Programmable Logic in a Single Modular Platform — for the First Time Ever.



- Communication, Logic, and Web Services
- Burner Control
- Flame Amplifiers
- Touch Screen Display
- Fuel/Air Ratio Control
- Alarm Annunciator
- Limit Control
- Analog And Digital I/O
- Smart Quarter-Turn Actuators

See pages 4–5 for the Honeywell SLATE Integrated Combustion Management System