

USER MANUAL

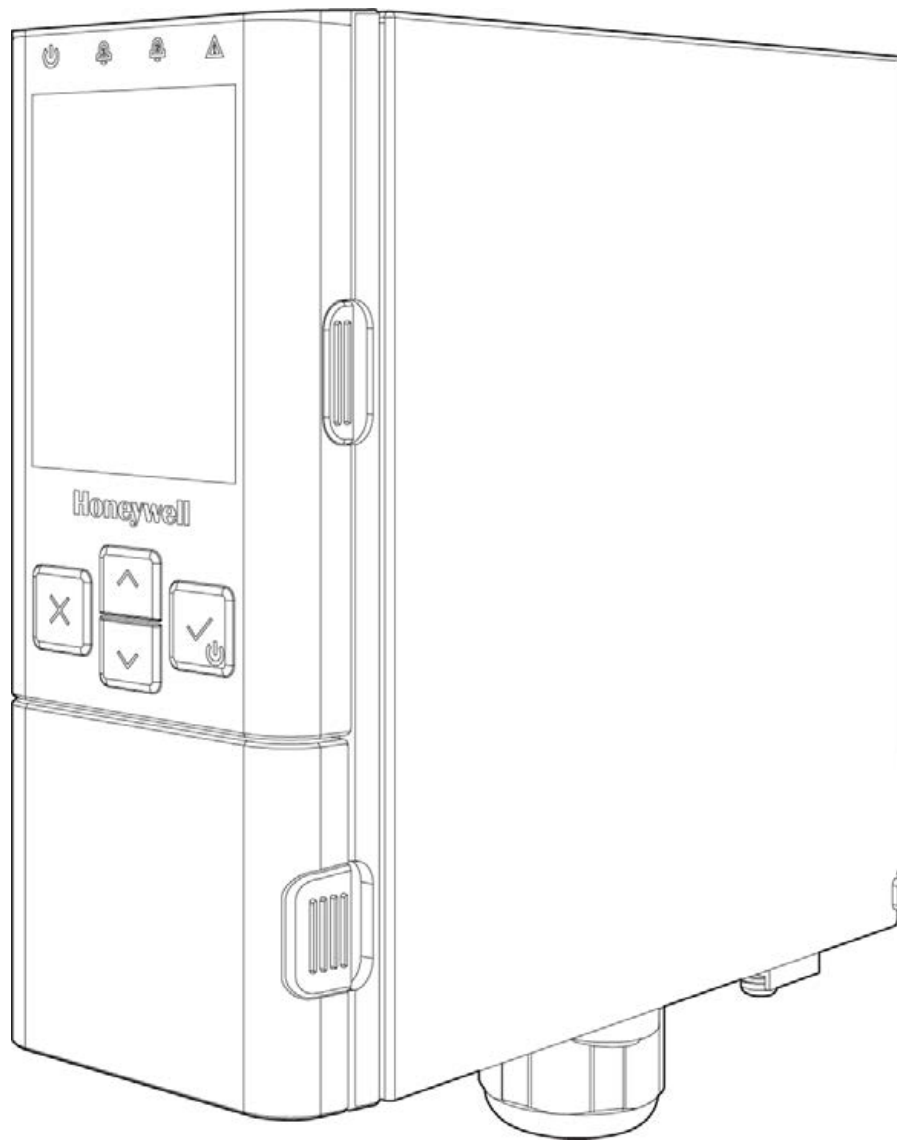

Midas® S2

Fixed single-point extractive gas transmitter

TOC

Chapter 1 - Introduction	5
1.1 Product Description	5
1.2 Safety	6
1.3 Certifications	7
1.4 What's in a Full Box System	7
1.5 Cleaning the system	7
1.6 Hardware Overview	8
1.7 User Interface Overview	9
1.8 Default Configuration	10
Chapter 2 - Installation	11
2.1 Dimensions	12
2.2 Mount the Device	13
2.3 Sample and Exhausting Tubing Calculations	15
2.3.1 Prepare tubing	16
2.4 In-Line Filters	16
2.5 Local Detector Option	16
2.6 Wiring	17
2.6.1 Terminal layout of the base module	17
2.6.2 Electrical installation	19
2.7 Attach the pyrolyzer or NDIR	21
2.8 Install the sensor cartridge	22
Chapter 3 - Device Operation	23
3.1 Turn the device on & off	23
3.2 Monitoring	24
3.3 Review Information	25
3.4 Calibration	27
3.5 Testing	28
3.6 Setup	29

3.7 Line Integrity Test	31
3.7.1 Install and leak check	32
Chapter 4 - Web operation	33
4.1 Internal Web Server	33
4.2 Physical Network Components	33
4.3 Internet Settings	33
4.4 Running the Web Server	34
4.5 Login	34
4.6 Device's Review	34
4.6.1 Review status	34
4.6.2 Review alarm & fault status	35
4.6.3 Review an event's history	35
4.6.4 Review a calibration certificate	36
4.7 Set-Up	36
4.7.1 Set up the location label	36
4.7.2 Set up the network	36
4.7.3 Set up the security	36
4.7.4 Set up the display	36
4.7.5 Set up the time/date	36
4.7.6 Set up gas detection and alarm set	36
4.7.7 Set up the fullscale	37
4.7.8 Set up the relays	37
4.7.9 Set up faults	37
4.7.10 Set a LIT	38
4.7.11 Zero calibration	38
4.7.12 Span calibration	38
4.7.13 Flow calibration	38
4.7.14 Calibrate 4-20 mA	38
4.7.15 Perform a LIT calibration	38
4.7.16 Perform a bump test	39
4.7.17 Perform an alarm or fault simulation	39
4.7.18 Perform a 4-20mA test	39

4.7.19 Perform the LIT	39
4.7.20 Inhibit mode	39
Chapter 5 - Maintenance	40
5.1 Block Test	41
5.2 Replace the Pump	42
5.3 Sensor Replacement	42
Chapter 6 - Additional Information	43
6.1 Calibration & Bump Test	43
6.1.1 Bump test	44
6.1.2 Preparation	44
6.1.3 Finishing	45
6.1.4 Troubleshooting	45
6.2 Waste Electrical and Electronic Equipment (WEEE)	45
6.3 Troubleshooting and Fault Diagnosis	46
6.4 Specifications	48
6.5 Ordering	49
6.6 Gas Table	50
6.7 Reflex	54
6.8 A Modbus/TCP Interface	55
6.9 Security	58
6.9.1 Modbus TCP	58
6.9.2 DOS attack	58
6.9.3 Install web server certificate in Google Chrome	58
6.9.4 Install web server certificate in MS Browsers	58
6.10 Warranty	59
6.10.1 Sensor Cartridges Warranty	60
6.11 Contact Us	61
6.11.1 Europe, Middle East, Africa	61
6.11.2 Asia Pacific	61
6.11.3 Americas	61
6.11.4 Technical Support	61

1 INTRODUCTION

1.1 Product Description

The Midas® S2 is a Fixed, Extractive Single-Point Gas Transmitter that draws a sample locally or from a remote point to a sensor cartridge. A wide range of toxic, flammable and oxygen gas sensor cartridges are available that enable the detection of gases used or generated in semiconductor manufacturing operations, light manufacturing environments, and national and university labs that specialize in semiconductor processing research.

Features and Benefits:

- Highly modular design for easy, reliable, and trouble-free installation.
- Quick replacement of cartridges and pump parts for simple maintenance.
- Single, smart sensor cartridge with onboard * 'e-calibration' certificate
- 3-built-in relays (Form C) for Alarms 1, 2, and Fault
- Modbus TCP/IP, TCP Ethernet, Power over Ethernet(PoE)
- Keypad interface
- Factory-calibrated sensors to reduce the need for frequent gas testing
- 4-20mA analog output with fault and event reporting
- Large, bright, and rich TFT color LCD and extensive viewing angle.
- Robust extractive pump system (2-year lifetime) sampling up to 100 feet
- Designed to ensure maximum uptime while providing a delightful user experience while using the machine and providing a low cost of ownership for the customers
- Block test to ensure sampling line connection and no leakage

1.2 Safety



CAUTION **RISK OF INJURY AND PROPERTY DAMAGE**

- To minimize the risk of electrostatic charging, provide a suitable ground connection, and install the equipment in such a way that no accidental discharges occur.
- When Midas S2 reaches the end of its life, it should be disposed of by local regulations.
- Do not use cleaning solvents or abrasives to clean the gas detector.
- Do not attempt to modify the product in any way from the manufacturer's design or specification. Warranty will be void and malfunction of the gas detector may result.
- Use only genuine spare parts and accessories with Midas S2. Malfunction may result if non-standard parts are used.
- Midas S2 is suitable for ordinary locations only and must not be installed in hazardous locations.
- Installation must be by the recognized standards of the appropriate authority in the country concerned. For Europe, see EN60079-14, EN60079-29-2, and EN61241-14. For installations in North America, the National Electrical Code (NFPA 70) should be strictly observed. All the appropriate local and national regulations should be observed.
- Indoor use only.



CAUTION **RISQUE DE BLESSURES ET DE DOMMAGES MATÉRIELS**

- Afin de minimiser le risque de décharges d'électricité statique, effectuez une mise à la terre adaptée et installez l'équipement de sorte qu'aucune décharge accidentelle ne puisse se produire.
- Lorsque le Midas S2 arrive en fin de vie, il doit être mis au rebut conformément aux réglementations locales.
- N'utilisez pas de solvants ou d'abrasifs pour nettoyer le détecteur de gaz.
- N'essayez pas de modifier l'appareil par rapport à la conception ou aux caractéristiques du fabricant. La garantie sera annulée et un dysfonctionnement du détecteur de gaz pourrait en résulter.
- Utilisez uniquement des accessoires et pièces de rechange d'origine avec le Midas S2. Un dysfonctionnement pourrait résulter de l'utilisation de pièces non conformes.
- Le Midas S2 doit être installé uniquement dans des endroits adaptés et non dans des zones dangereuses.
- L'installation doit être effectuée en conformité avec les normes reconnues de l'autorité compétente du pays concerné. Pour les installations en Europe, consultez les normes EN60079-14, EN60079-29-2 et EN61241-14. Pour les installations en Amérique du nord, le National Electrical Code (NFPA 70) doit être respecté à la lettre. Toutes les réglementations locales et nationales en vigueur doivent être respectées.
- Utilisation en intérieur uniquement.

1.3 Certifications

Electrical: UL 61010-1,
CSA C22.2 No.61010-1,
IEC 61010-1,
EN 61010-1

ROHS: EU Directive 2015/863

EMC: EN 50270:2015



1.4 What's in a Full Box System

- Midas S2 transmitter
- Installation accessories (tubes, tube adaptor or LIT check valve if ordered)
- Quick reference guide
- ROHS sheet with drill template
- Demount handle

1.5 Cleaning the system

Clean the exterior of the instrument with a soft, damp cloth. Use only water-based (non-alcohol) cleaners. Do not use soaps, solvents, or polishes.

1.6 Hardware Overview

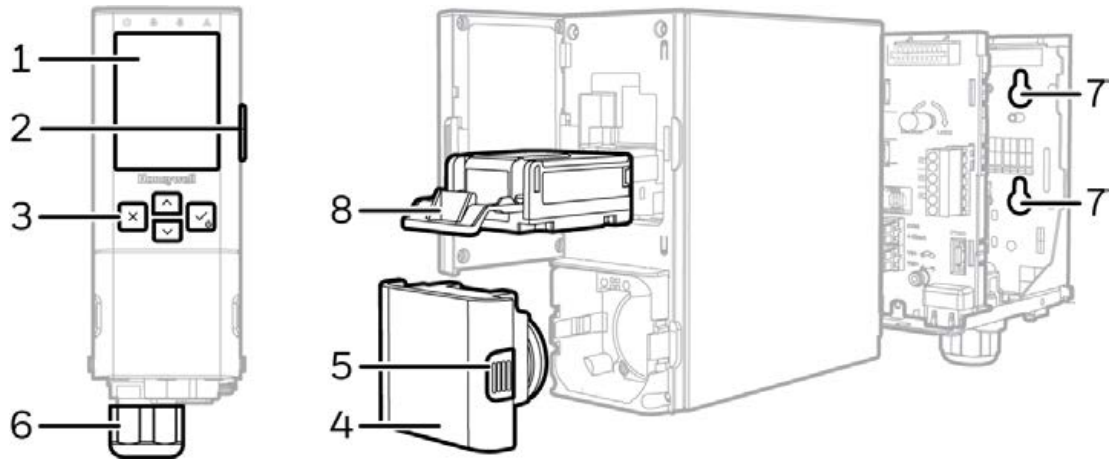

1	Display	2	Pump door latch
3	Navigation buttons	4	Sensor cartridge
5	Sensor release latch	6	Cable gland
7	Mounting holes	8	Pump module

FIGURE 1 -1: Hardware components

1.7 User Interface Overview

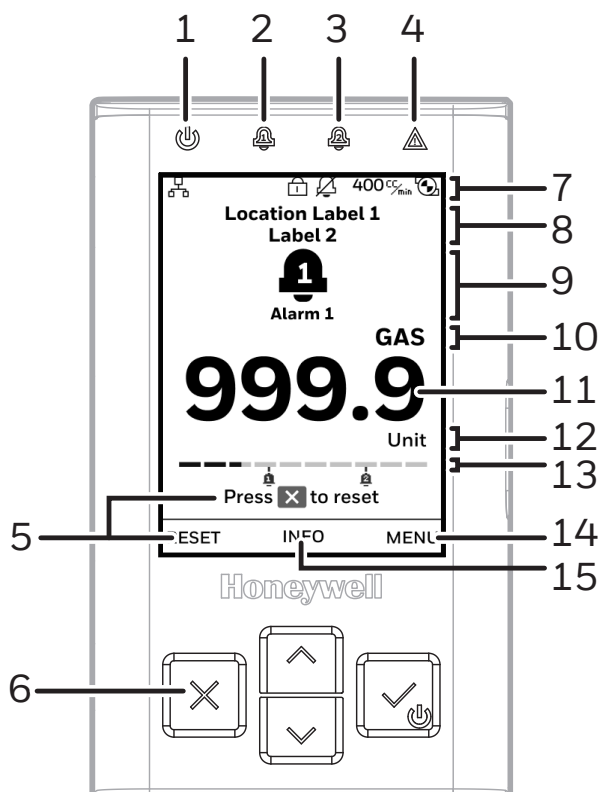

1- Power LED		2- Alarm 1		3- Alarm 2	
4 - Fault		5 - Tips for reset faults or alarms		8- Location label	
6 - Buttons		7 - Device status icons		9 - Main status icons	
	Cancel. Reset alarm or fault		Network connected		Normal
	Accept Power ON/OFF		Network not connected		Alarm 1
	Up		Password enabled		Alarm 2
	Down		Inhibit mode is enabled		Fault
			Flow rate		Inhibit mode
			Internal pump running		
10- Gas name		11 - Gas concentration		12 - Unit	
13 - Bar graph for gas concentration display		14 - Menu		15 - Information	

FIGURE 1 -2: Device's interface components

1.8 Default Configuration

The Midas S2 gas detector is factory-configured.

NOTE: Oxygen levels are 20.9% v/v in a normal atmosphere, equivalent to 17.3 mA. Use caution when integrating an oxygen Midas S2 unit using the 4-20 mA output since fault, inhibit, and no power conditions are below 4 mA and, by default, an oxygen depletion alarm is triggered on a falling alarm (default 19.5% v/v). In that case, Honeywell recommends one of the following:

- Use Modbus TCP digital communications
- Use discrete relay inputs instead of a 4-20 mA signal to trigger gas alarms
- Program the control system of the 4-20 mA input with logic and a delay (e.g., 1 second) before triggering an alarm to determine if the 4-20 mA output is at one of the 0-4 mA conditions described above.

Contact Honeywell for further information.

TABLE 1 -1: Factory Default Configuration

	Toxic Gas	Flammable Gas	Oxygen ¹
Full Scale (FS)	Typically 4 x Threshold Limit Value (TLV)	100% Lower Explosive Limit (LEL)	25% Volume (v/v)
Alarm 1 (Relay 1)	Typically 1/2 TLV Normally de-energized, energizes on alarm.	10% LEL	23.5% v/v (Rising)
Alarm 2 (Relay 2)	Typically 1 TLV Normally de-energized, energizes on alarm.	20% LEL	19.5% v/v (Falling)
Fault (Relay 3)	Normally energizes, de-energized on fault.		
Latching	Latching. Alarm and fault relays DO NOT automatically reset when reading falls below alarm thresholds. Relays MUST be manually reset.		
Passcode	No Passcode set.		
Address	192.168.0.14 subnet mask 255.255.255.0		
Current source with:			
0 mA	Fault (open circuit)		
1.0 mA	Fault		
2.0 mA	Inhibit		
3.0 mA	Maintenance Fault		
4.0 to 20.0 mA	Gas reading (normal operation)		
21.0 mA	Over range		

¹ Please contact Honeywell sales.

*LIT is disabled as it is an optional function.

2 INSTALLATION

For ease of installation Midas S2 has been designed to allow the installation of the mounting bracket assembly and main module separately from the other parts of the detector. The detector location and hard wiring can therefore be completed before fitting the detector's main module and sensor cartridge.



CAUTION RISK OF DEVICE MALFUNCTION

Midas S2 is designed for installation and use in indoor safe areas and non-explosive atmospheres. Installation must follow the recognized standards of the appropriate authority in the country concerned. Before installing, ensure local regulations and site procedures are followed.

Ensure the connection of all modules (e.g pump and cartridge module) with the main module. Otherwise, Midas S2 can have flow leakage or malfunction.



CAUTION RISQUE DE DYSFONCTIONNEMENT DE L'APPAREIL

Midas S2 est conçu pour être installé et utilisé dans des zones sécurisées intérieures et des atmosphères non explosives. L'installation doit suivre les normes reconnues par l'autorité compétente du pays concerné. Avant l'installation, assurez-vous que les réglementations locales et les procédures du site sont respectées.

Assurez-vous de la connexion de tous les modules (par exemple pompe et module de cartouche) avec le module principal. Sinon, Midas S2 peut présenter une fuite de débit ou un dysfonctionnement.

2.1 Dimensions

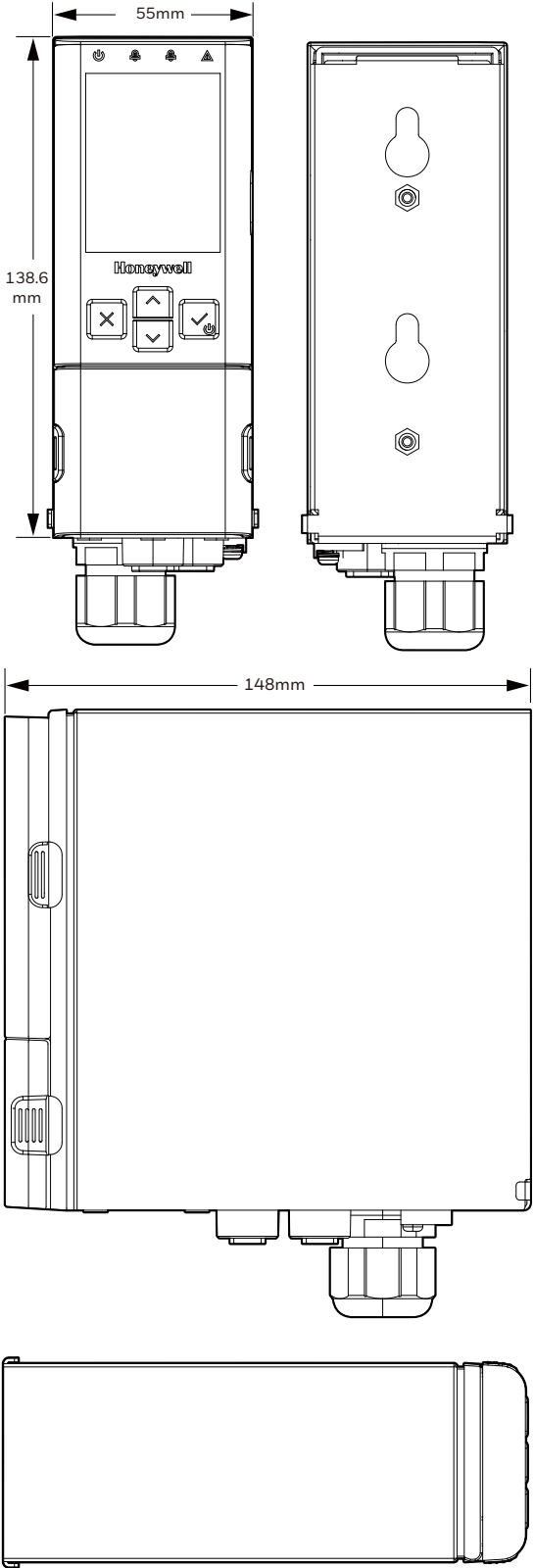
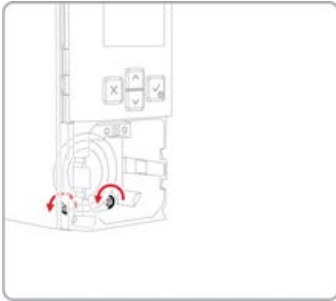

FIGURE 2 -1: Midas S2 dimensions

2.2 Mount the Device

Mounting the device on a vertical flat surface.

1. Unscrew the two screws located on the main module.



2. Remove the primary module by pulling it forward off the base module. While separating the base module from the main module, please use the enclosed accessory handle on the back of the product, as depicted in the picture.

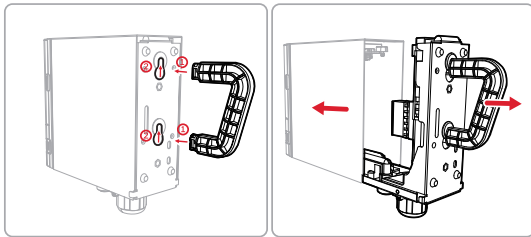

3. Unscrew the retaining screws located at the base module, and then, remove the back plane PCB module.

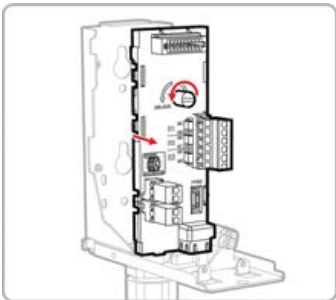

4. Drill two holes 2.24in (56.8mm) vertically apart for 2 x round head M4 screws, using the separately provided drill template on the ROHS sheet.

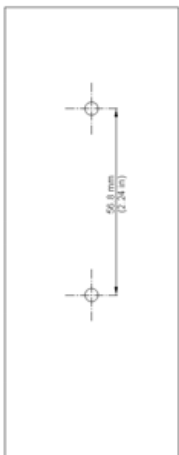

5. Partially screw the fixings into the mounting surface.
6. Place the mounting bracket assembly over the screws, so they pass through the mounting holes and then slide down to locate in the slots.

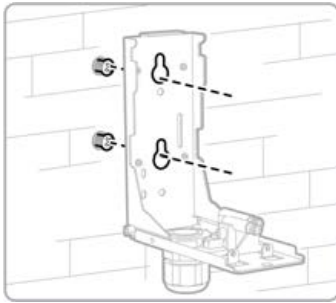

7. Tighten the screws to secure the mounting bracket assembly.
8. Align the RJ45 socket of the power PCB module in the hole of the mounting bracket to refit the PCB.

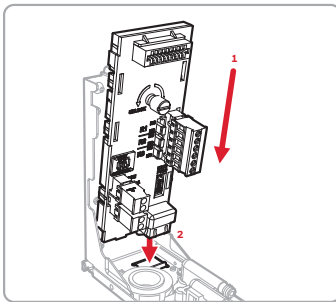

9. Tighten the retaining screw to secure the power PCB module.

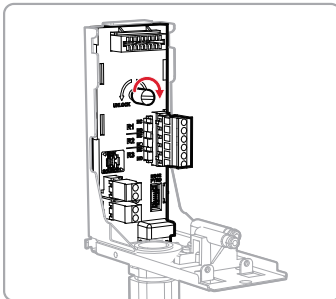

10. Wire the device as described in the "Wiring" section.
11. Place the main module back into the base module.

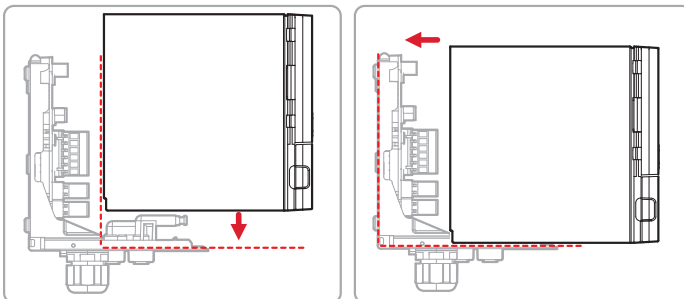

12. Screw the 2 screws located on the main module, as identified in Step 1.

NOTE: Depending on the installation environment of the device, there may be a variation in pump operation performance due to vibration of a specific frequency or direction, so check regular pump operation after installation. If you need technical assistance, please contact the Honeywell Service Team.

2.3 Sample and Exhausting Tubing Calculations

Description of flow rate, maximum pressure, and vacuum at the inlet and exhaust points.

TABLE 2 -1: Inlet sample specifications

Description	Maximum
Tubing Length, m (ft)	30 (100)
Back pressure at exhaust point	-25.4 cm H ₂ O (-10 in H ₂ O)
Back pressure at exhaust point with LIT Check Valve	-12.7 cm H ₂ O (-5 in H ₂ O)
Transport Time (sec), ID 1/8" ¹	25
Transport Time (sec), ID 3/16"	53
Flow rate, cc/min.	500 (Flow is constant) ²
Tubing OD, mm (in)	6.35 (0.25)
Tubing ID, mm (in)	3.18 (0.125)

¹Honeywell recommends thick-wall tubing (1/8" ID) for best speed of response. Due to its lower surface area, thick-wall tubing may require less conditioning than thin-wall tubing.

² The flow rate is electronically maintained at approximately 500 cc/min and may vary within acceptable tolerances.

Tubing lengths vary among gases. See the Topic 6.6: Gas Table for recommended lengths.

NOTE: Honeywell recommends the use of Teflon FEP (Fluorinated Ethylene Polymer) tubing to assure proper sample transport. The properties of Teflon FEP make it the best choice for transporting sample toxic gases to instruments when compared with the properties of other similar tubing materials.

TABLE 2 -2: Outlet sample specifications

Description	Maximum
Tubing Length, m (ft)	30 (100)
Back pressure at exhaust point	20.3 cm H ₂ O (8 in H ₂ O)
Back pressure at exhaust point with LIT Check Valve	10.16 cm H ₂ O (4 in H ₂ O)
Flow rate, cc/min	500 (Flow is constant)
Tubing OD, mm (in)	6.35 (0.25)
Tubing ID, mm (in)	4.76 (0.188)

2.3.1 Prepare tubing

1. Cut the tube squarely and remove any burrs.
2. Mark from end of tube the length of insertion. The insertion length of Midas S2 from the end of tube is 15.5 mm.

NOTE: When inserting the tube into the inlet/outlet port of the Midas S2, make sure that it is inserted up to the marked position.

2.4 In-Line Filters

External filters must be used to protect the tubing from contamination. Use particulate filter part number 780248 for normal gases and 1830-0055 or 1991-0147 for corrosive gases. Replace the filter every 3 months. Refer to the Topic 6.6: Gases Table for specific gases.

2.5 Local Detector Option

The Midas S2 gas detector can also be used to monitor for gas at the location of the detector. To do this, an inline filter is connected to the gas inlet port with the proper filter option of In-Line Filters. The area around the detector is then being monitored as opposed to a sample being drawn from a remote location.

2.6 Wiring

Access for the electrical wires to the terminal module is made via the PG16 cable gland located at the bottom of the mounting bracket assembly. The cable gland can be removed and replaced with a suitable conduit fitting if required.

The terminals used are suitable for conductors of 24 to 14 AWG (0.5 to 1.8mm Dia.). We recommend using the 16 AWG (1.5 mm Dia.) conductors.

2.6.1 Terminal layout of the base module

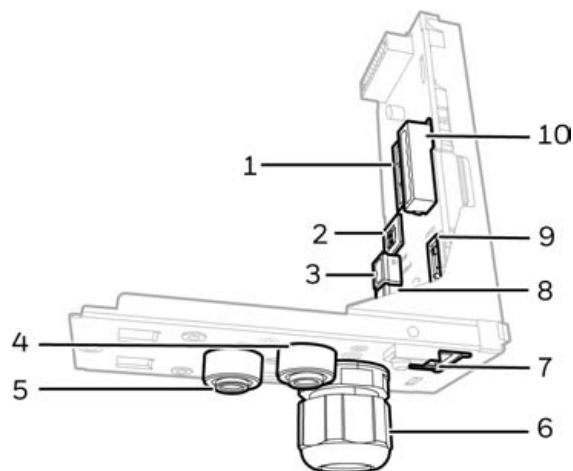

1	Relay NO/NC jumpers	2	4-20mA analog sink/source switch
3	4-20mA analog output terminals	4	Gas outlet port
5	Gas inlet port	6	Cable entry
7	RJ45 connector for ethernet/PoE	8	24Vdc Power terminals
9	Pyrolyzer or NDIR connector	10	Relay Contact terminals

FIGURE 2 -2: Base module components

Midas S2 can be powered by either 24 VDC via traditional discrete wiring or by approximately 48 VDC delivered through the Ethernet cable from a PoE source. In either case, the 4-20 mA analog output can be used.

NOTES:

- Midas S2 allows only one power source, 24 VDC or PoE. Failure to observe this requirement may cause damage to the gas detection system and will not be covered by the standard warranty
- Earthing Requirements: If the Midas S2 unit's mounting bracket is not connected directly to a metal surface for earthing purposes, an additional earth wire will be required. Connect a wire via the PG16 gland to the dedicated earth tag (screw terminal) located on the bottom bracket and connect the other end of the wire to a dedicated external earthing point. If Power over Ethernet (PoE) power supply is being used, shielded CAT5 or equivalent Ethernet cable is recommended. Please ensure that your wiring avoids earth ground loops that may affect the performance of your equipment.

- Instrument grounding is required to ensure stable performance and to limit the effects of radio frequency interference before installation.

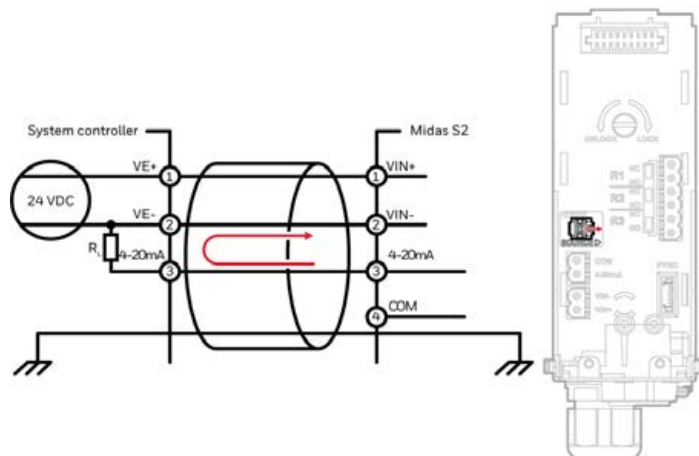

FIGURE 2 -3:
Detector Source Mode with DC Power

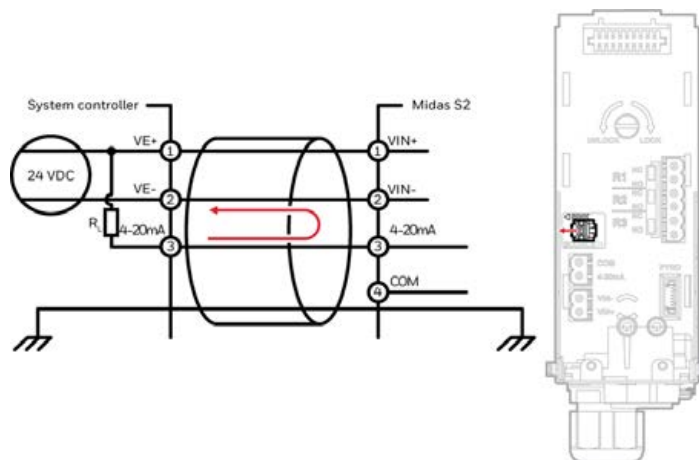

FIGURE 2 -4:
Detector Sink Mode with DC Power

- Pull the terminal blocks to remove them from the connector module.
- Connect the cables to the terminal blocks, referring to the relevant wiring diagram. Strip and insert the end of each wire into the corresponding terminal hole. Using a flat-blade terminal screwdriver, tighten the terminal screw until the wire is secured. Use a ferrule on the wire when necessary. **IMPORTANT:** Do not over-tighten the terminal screw.
- When wiring the Midas S2 Transmitter to a controller, program the controller for a 1-2 second delay before reporting to prevent false alarms.

2.6.2 Electrical installation

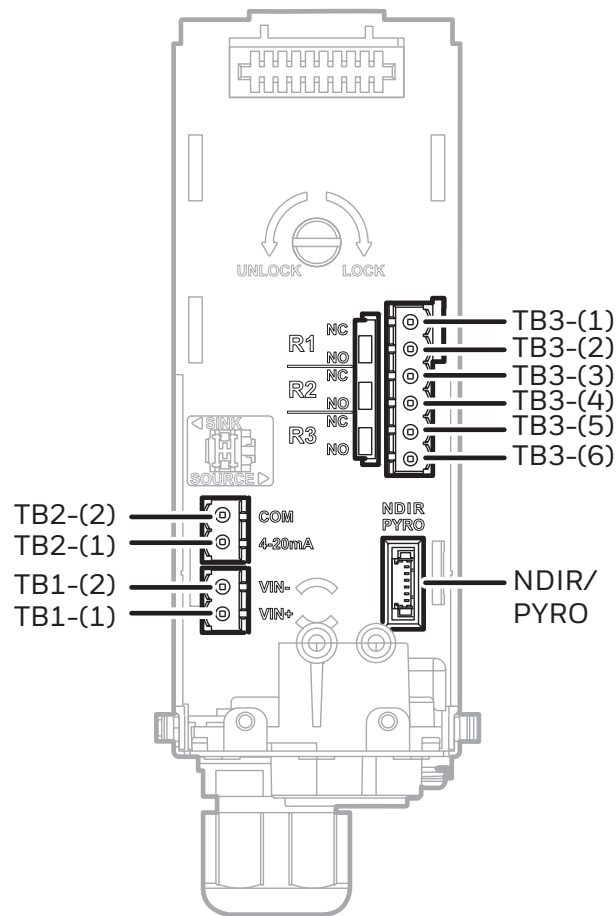

FIGURE 2 -5: Electrical terminals

Reference	Category	Description
TB1-(1)	DC power	24Vdc input – VIN+
TB1-(2)	DC power	0Vdc – VIN-
TB2-(1)	mA output	4-20mA analog output
TB2-(2)	mA output	COM
TB3-(1)	Relay1	Alarm1 – COM
TB3-(2)	Relay1	Alarm1 – NO/NC (default NO)
TB3-(3)	Relay2	Alarm2 – COM
TB3-(4)	Relay2	Alarm2 – NO/NC (default NO)
TB3-(5)	Relay3	Common Fault – COM
TB3-(6)	Relay3	Common Fault – NO/NC (default NO)
NDIR/PYRO		Pyrolyzer or NDIR connector

Relay rating : 1.0A@30VDC or 0.5 A@125 VAC max.

Default configuration

All alarm relays	Normally de-energized, energized on alarm
Common fault relay	Normally energized, de-energized on fault

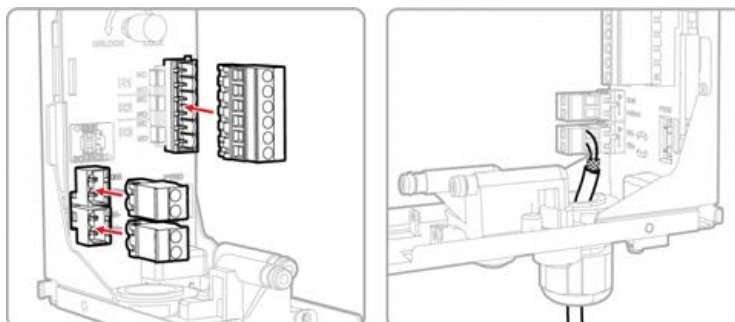

FIGURE 2 -6: Connecting the cables to the terminal block

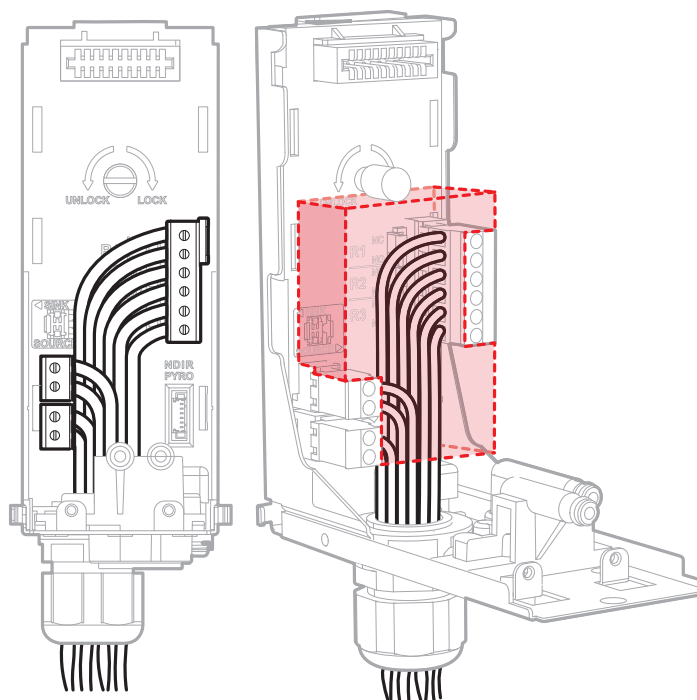

FIGURE 2 -7: Wiring area

Note: Wiring should be executed within the shaded area.

2.7 Attach the pyrolyzer or NDIR

1. Turn the power off.
2. Remove the main module as described in the Mount the Device process.
3. Plug the connector into the socket (as indicated in the image) at the bottom right of the terminal module through the rectangular access of the mounting bracket. Align the fitting at the top rear of the pyrolyzer or NDIR with the gas inlet port at the bottom of the mounting bracket.
NOTE: Please secure no tubing leakage between the base module and NDIR through the blocking test after NDIR installation.
4. Connect the pyrolyzer or NDIR to the detector with the three provided mounting screws
5. Place the main module and screw the two screws referring to steps 11 and 12 of 'Mounting the device.'

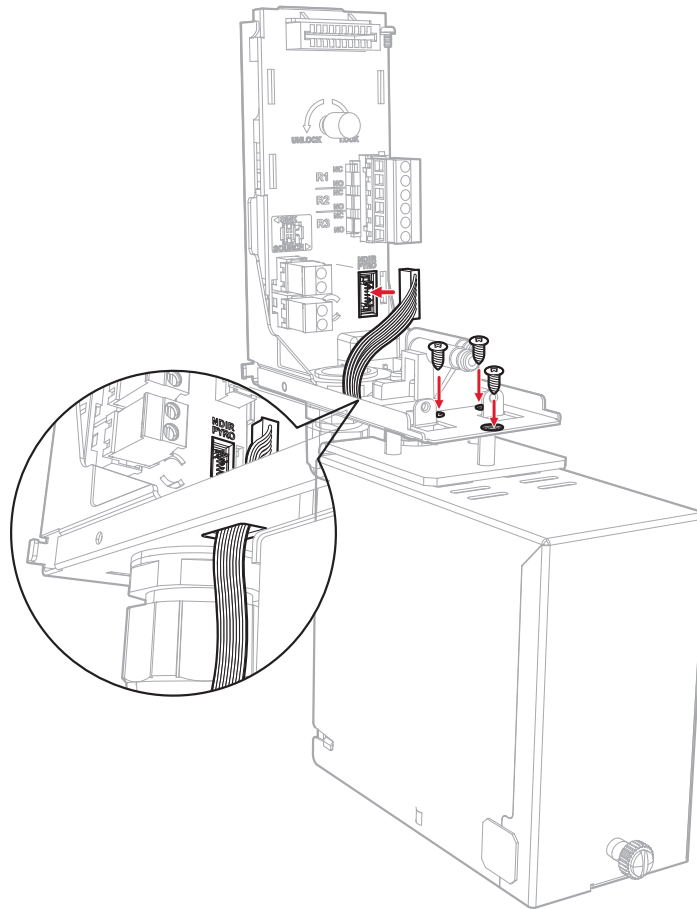

FIGURE 2 -8: Pyrolyzer socket

2.8 Install the sensor cartridge

1. Turn the power off.
2. Verify that the part number and type of sensor cartridge are correct for your application, then remove the sensor cartridge from the packaging. Remove the Bias battery module and plug caps from the sensor cartridge if needed.
3. Push the **sensor cartridge** gently until fully seated.

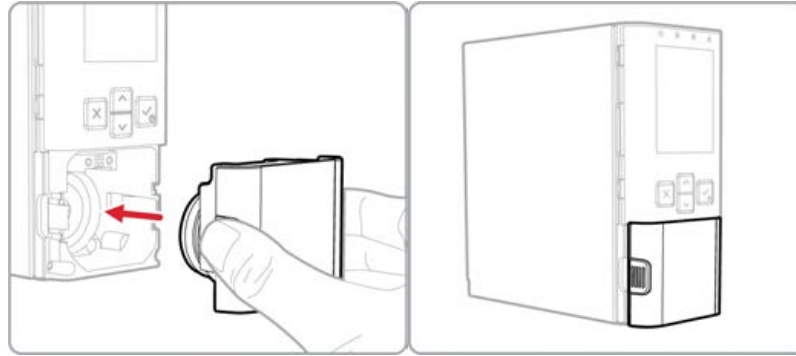

FIGURE 2 -9: Installing the sensor cartridge

4. Turn the device ON.
NOTE: There is a connecting and warm-up time which is different according to the sensor type (Max. 30 mins) for first use. Please wait until the start-up finishes and display the sensor type on the screen.
5. Confirm the display for gas type and concentration on the screen.
NOTE: All sensor cartridges are supplied calibrated. Some sensor cartridges can monitor for more than one type of gas. Please refer to Topic 3.6.1: Gas type change and Topic 3.7: Sensor replacement for details.

3.1 Turn the device on & off





FIGURE 3 -1: Turn the device on & off



CAUTION RISK OF PROPERTY DAMAGE

DO NOT disassemble the main module with the power ON status

NOTE: Please press  to turn the device off. In another case, such as plugging the power cable out, including PoE, the device can be powered on automatically. Midas S2 records the last power-off condition and reproduces that status to prevent it from not working when the power comes back after an unintentional sudden power interruption. Please note this, and if you want to keep the power off while it is connected, press .

3.2 Monitoring

After commissioning, the Midas S2 detector is set in the Monitoring Mode, which is the starting point for all of the device's operations.

The examples in the following table are for a linear 4-20 mA output over a full scale range of 2 ppm. The current output for a given gas concentration will be different for other full scale ranges (linear 4 mA = 0 % full scale to 20 mA = 100 % full scale). The alarm and fault relays are in default (latching) mode.

TABLE 3 -1: Normal operation display and outputs

This table is based on the default configuration of toxic sensor type.

Status	Relay Status	4-20mA out-put	LEDs	Backlight
Alarm 1	Alarm relay 1 activated Alarm relay 2 deactivated Fault relay deactivated	mA output to match the concentration	Green flash Alarm 1 Red on	Red on of the channel
Alarm 2	Alarm relay 1 activated Alarm relay 2 activated Fault relay deactivated	mA output to match the concentration	Green flash Alarm 1 Red on Alarm 2 Red flash	Red flash of the channel
Greater than full scale	Alarm relay 1 activated Alarm relay 2 activated Fault relay deactivated	21mA	Green flash Alarm 1 Red on Alarm 2 Red flash Yellow on	Yellow on of the channel
Inhibit	Alarm relay 1 deactivated Alarm relay 2 deactivated Fault relay deactivated	2mA	Green flash	
Maintenance fault	Alarm relay 1 deactivated Alarm relay 2 deactivated Fault relay deactivated	3mA	Green flash Yellow on	Yellow on of the channel or all channels dependent on fault type
Instrument fault	Alarm relay 1 deactivated Alarm relay 2 deactivated Fault relay activated	1mA	Green flash Yellow flash	Yellow flash of the channel or all channels dependent on fault type

3.3 Review Information

From the **Information** menu, you can see the information of transmitter, cartridge, alarm, 4-20mA, fault, calibration, date/time, network, event log, and advance.





1. Go to the Monitoring mode.
2. Press  to enter the Information menu.
3. Press  or  buttons to scroll to your desired option.
4. Press  to accept and enter the selected option.
5. Optional Step: Press  to return one step back.

Table 3-2: Information menu

Option	Information you can review from selected option
Transmitter	<ul style="list-style-type: none"> • FW version • Part Number • Serial Number • FW checksum
Cartridge	<ul style="list-style-type: none"> • FW Revision • Part Number • Serial Number • Sensor parameter revision • Sensor expired days • Pyrolyzer status
Alarms	<ul style="list-style-type: none"> • Gas type • Alarm 1 type and level • Alarm 2 type and level • Deadband status • Alarm latching/non-latching • Alarm delay time
4-20mA	Concentration range of 4-20mA output
Faults	<ul style="list-style-type: none"> • Latching/Non-latching • Maintenance fault enable/disable • Temperature fault enable/disable
Calibration	<ul style="list-style-type: none"> • Calibration interval • Calibration due days • Span target
LIT (optional)	<ul style="list-style-type: none"> • LIT status • LIT test time

Option	Information you can review from selected option
Date/Time	Date and Time
Network	<ul style="list-style-type: none">• IP obtain method• IP address• Subnet Mask• Gateway• MAC Address
Event Log	Event logs

3.4 Calibration

From the Calibration Mode, you can configure Zero, Span, Flow, 4-20mA, and Line Integrity Test.

1. Go to the Monitoring mode.
2. Press and select **Calibration**, and then press to enter the menu.
3. Press or to scroll the options, and then press to accept it.
4. Optional Step: Press to cancel and return one step back.

Table 3-3: Calibration menu

Option	Operations you can calibrate from the selected option
Zero	Zero gas calibration
Span	Span gas calibration ¹
Flow	Pump flow calibration ²
4-20mA	4-20mA output calibration
LIT	LIT calibration

¹Calibration can be performed with secondary and primary gases except Midas S2-E-XHF, which should be implemented with only HF gas and without Pyrolyzer. If a target gas is different from the set gas type, the setting must be changed to the target gas type before entering the calibration menu and then should go back after calibration. Please refer to Topic 6.6: Gas Table for details.

²Do not apply external force to the device during flow calibration, as it may affect the flow value.

3.5 Testing

From the Test Mode, you can test Bump, Inhibit, 4-20mA, Alarm/Fault simulation, Relay, Line Integrity Test, and Blocking test.







1. Go to the Monitoring mode.
2. Press  and select **Test Mode**, and then press  to enter the menu.
3. Press  or  to scroll the options, and then press  to accept it.
4. Optional Step: Press  to cancel and return one step back.

Table 3-4: Test mode menu

Option	Operations you can Test from the selected option
Bump	<ul style="list-style-type: none"> • Gas bump test . For bump test details, please refer to the Topic 6.1:Calibration & Bump test
Inhibit	<ul style="list-style-type: none"> • Inhibit ON/OFF • Inhibit time • Inhibit current level
4-20mA	<ul style="list-style-type: none"> • Force 1mA - 21mA output of each channel
Alarm/Fault simulation	<ul style="list-style-type: none"> • Alarm 1 • Alarm 2 • Maintenance Fault • Instrument Fault
Relay	<ul style="list-style-type: none"> • Relays 1, 2 and Fault • Relay energized/de-energized in normal condition
LIT (optional)	<ul style="list-style-type: none"> • LIT Test
Blocking test	

NOTE: All test items display results only within the test mode, and the device goes back to the normal status when exiting the test mode except LIT test. If the LIT test fails, the monitoring mode shows the LIT fail and fault indication.

3.6 Setup

From the **Setup Operations** menu, you can configure passcode, alarms, fullscale, relays, faults, calibration interval, bump test interval, Line Integrity Test interval, date & time, network, pump control, location label, and display.







1. Go to the Monitoring mode.
2. Press  and select **Setup Operations**, and then press  to enter the menu.
3. Press  or  to scroll the options, and then press  to accept it.
4. Optional Step: Press  to cancel and return one step back.

Table 3-5: Setup Operations menu

Option	Operations you can Setup from selected option
Passcode	<ul style="list-style-type: none"> • Enable • Disable • Change passcode (when set already)
Alarms	<ul style="list-style-type: none"> • Gas type • Alarm 1 type and level • Alarm 2 type and level • Deadband enable/disable • Alarm latching/non-latching • Alarm delay time
Fullscale	
Relay	<ul style="list-style-type: none"> • Relay configuration • Alarm relay (Energized/De-energized) • Fault relay (Energized/De-energized)
Faults	<ul style="list-style-type: none"> • Latching/Non-latching • Maintenance fault enable/disable • Temperature fault enable/disable
Calibration interval	The calibration interval in days
Bump Test interval	The bump test interval in days
LIT (optional)	<ul style="list-style-type: none"> • Line leak test (enable/disable) • LIT interval (8-72 hours)
Date/Time	<ul style="list-style-type: none"> • Date • Date format (YYYY MM DD, DD MM YYYY, MM DD YYYY)

Option	Operations you can Setup from selected option
	<ul style="list-style-type: none"> • Time
Network	<ul style="list-style-type: none"> • IP obtain method (Auto/Manual) • IP address • Subnet Mask • Gateway
Pump control	55Hz/60Hz/65Hz/69Hz/73Hz/77Hz selectable in manual control ¹
Location label	Labels 1 & 2
Display	<ul style="list-style-type: none"> • Brightness • Auto backlight off

¹The device detects the optimization frequency automatically; it is not recommended to switch to manual control of the pump without a specific reason. Switching to manual control may cause damage to the pump.

3.7 Line Integrity Test

Honeywell offers the optional capability to check for leaks in Midas S2 sample lines. Midas S2 Transmitter for Line Integrity Test detects any leak in the tubing with a pneumatic signal change from the valves installed at the end of the sample line. This test is performed automatically as a Line Integrity Test. The Line Integrity Test Option requires the Calibration process.



CAUTION RISK OF MALFUNCTION

- If you make any changes to the Pump Module, Check Valve, Filter, and Tube, start a new Line Integrity Test calibration again.
- Verify the Check Valve flow direction during installation.
- Verify both the Check Valve and Tube are firmly assembled.
- Mark the insertion from the end of the tube to the length of 15.5mm. When inserting the tube, make sure the insertion is up to the marked position.
- The external filter is installed further from the Transmitter and the Check Valve is installed closer to the transmitter.



CAUTION RISQUE DE DYSFONCTIONNEMENT

- Si vous apportez des modifications au module de pompe, au clapet antiretour au filtre et au tube, refaites un nouvel étalonnage du test d'intégrité de la ligne.
- Vérifiez le sens de circulation du clapet anti-retour pendant l'installation.
- Vérifiez que le clapet antiretour et le tube sont solidement assemblés.
- Marquez l'insertion sur l'extrémité du tube à la longueur de 15,5 mm. Lors de l'insertion du tube, assurez-vous que l'insertion atteint la position marquée.
- Le filtre externe est installé plus éloigné de l'émetteur et le clapet antiretour est installé plus près de l'émetteur.

3.7.1 Install and leak check

1. Mount the Midas S2 using the integral mounting bracket.
2. Connect the actual inlet & outlet tubes to Midas S2 and turn on the system.
Verify the Check-Valve is attached to the Sampled Point.
After the Power ON, wait approximately 10 minutes for pump stabilization and corrective measures.

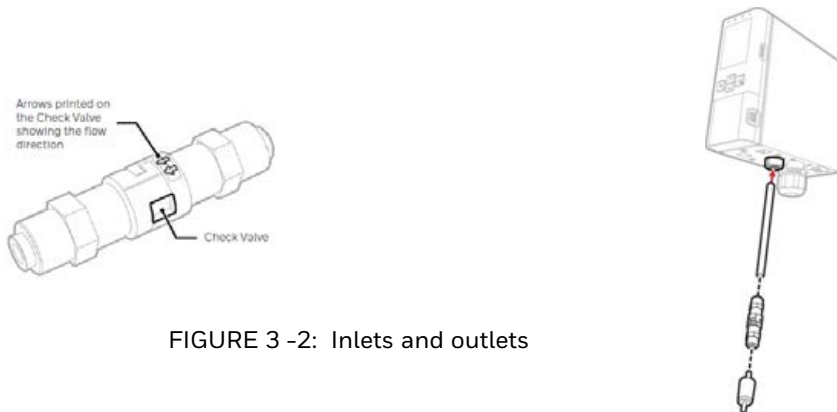

3. Implement the LIT calibration first to enable the LIT function.

NOTES:

- Please secure no leakage of the sampling line through the blocking test before LIT calibration for the accurate operation of LIT during initial installation.
 - Neither LIT nor LIT calibration can guarantee a line's leak integrity without a blocking test.
 - If there's any change in the sampling line, we recommend performing the blocking test and LIT calibration again.
4. If LIT calibration is passed, activate the LIT function in the Setup Operations menu and set the LIT interval.

NOTES:

- LIT function activation is impossible if LIT calibration was not operated or failed.
- You can test LIT manually in Test mode. Go to the Monitoring mode, select **Test** mode, press , select LIT, press and follow onscreen instructions.

4 WEB OPERATION

4.1 Internal Web Server

The Midas S2 gas detector unit utilizes an Ethernet port with the TCP/IP protocol as standard. The Midas S2 can function as a HTML web page server and these web pages can be viewed on external computer equipment (PC, PocketPC etc.) by using any Web browser, i.e.; Microsoft Bing, Safari, or Google Chrome . These web pages replicate the user interface on the front panel of the Midas S2 in a more flexible and friendly format for diagnostic and data entry purposes. The web pages also contain additional features not available via the keypad.

This procedure explains how to view web pages for a single Midas S2 which is connected to a single PC only. Of course it is possible to connect hundreds of Midas S2 units to an Ethernet network. More information may be required from the local IT department and Honeywell as appropriate.

4.2 Physical Network Components

The Ethernet physical network is intended to connect computers to other computers through hubs. Midas S2 has a 10/100 Mbps Ethernet transceiver and supports Auto-MDIX. It supports Auto-Negotiation for selecting the highest performance mode of operation. To use CAT5 standard or higher shield Ethernet cable is recommended for the highest efficiency communication speed.

4.3 Internet Settings

Communications requires knowledge of the IP address and netmask of both the Midas S2 and the PC. Unless the Midas S2 is connected to a network with a DHCP server, the addresses must be set manually.

In the usual case the netmask for both computers should be set to 255.255.255.0. The most-significant three bytes of the IP address must be identical and the least-significant byte must be unique. For example, if the IP address of the Midas S2 was set to 192.168.0.14 (the factory default) then an appropriate IP address for the PC would be 192.168.0.15.

4.4 Running the Web Server

In a web browser, set the URL to “http://xxx.xxx.xxx.xxx” where the “xxx” fields are replaced with the IP address of the Midas S2.

4.5 Login

You need to login to Set-up, Calibrate, or Test your device.

Click LOGIN in the upper right corner and enter your User Name/Password.

4.6 Device's Review

Display general information about the device and gas information such as Status, Event History, and Calibration certificate.

4.6.1 Review status

From the home page, select **Review > Status**.

Click the **Information** tab to get detailed info.

TIP: Hover your mouse over the alarm icons to see the alarms preset values.

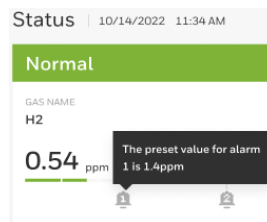

FIGURE 4 -1: Alarm preset values

4.6.2 Review alarm & fault status

The figure consists of two screenshots of the Honeywell Midas S2 web interface. The top screenshot shows the 'Alarm 1' status. The interface includes a navigation menu on the left with options like Review, Status, Event History, Calibration Certificate, Set-up, Calibration, Test, and Passcode. The main content area displays the gas name 'H2', location labels 'Seoul' and 'Silicon Valley Lab', and a gas concentration of 0.54 ppm. Below this, there are sections for 'Detector' and 'Sensor' with various parameters like Location, Name, Transmitter S/N, Cartridge S/N, Cartridge P/N, Sensor ID, and Sensor data. A 'RESET ALARM' button is visible at the bottom right.

The bottom screenshot shows the 'Fault' status. It displays the same gas name 'H2' and location labels. The gas concentration is 0.54 ppm. Below this, there are sections for 'Operation Status' and 'Information' with parameters like FLOW (400 cc/min), TEMPERATURE (22.0 °C), CALIBRATION DUE (37 days), and CELL EXPIRE (37 days). A 'RESET FAULT' button is visible at the bottom right.

FIGURE 4 -2: Alarm & fault status

4.6.3 Review an event's history

View information about records in text format and as a detailed graph.

Go to **Review < Event History**

The following graph shows detailed information about the selected event. The graphic displays the gas concentration before and after a specific time from when the event occurred.

4.6.4 Review a calibration certificate

Get the calibration information implemented on a per-channels basis when the device was manufactured. Go to **Review > Calibration Certificate**

4.7 Set-Up

4.7.1 Set up the location label

Go to Set-up > General and click on the **Location Label** tab.

4.7.2 Set up the network

Go to Set-up > General and click on the **Network** tab.

You can set the network as follows:

- **Obtain IP:** You can select whether Manual or Automatic.
- **Ip address, Subnet, and Default gateway** are enabled only when the **Obtain IP** option is set to Manual.
- **Hostname:** Hostname setting.

4.7.3 Set up the security

Go to Set-up > General and click on the **Security** tab.

4.7.4 Set up the display

Go to Set-up > General and click on the **Display** tab.

4.7.5 Set up the time/date

You can set the Time and Date in a 24-hour format and synchronize it with the computer. Go to Set-up > General and click on the Time/Date tab.

4.7.6 Set up gas detection and alarm set

Go to Set-up Operations> Gas/Alarm.

1. **Gas:** Set the gas you want to detect. Gas-name and K-factor (weight value for gas value) can be set only for User-gas.

Note: You cannot set the range.

2. Set the concentration at which Alarm1 occurs.
3. Set the concentration at which Alarm2 occurs.
4. Enter the **Dead band**.
5. Enter the **Alarm delay**. When an alarm condition is reached, an alarm occurs at a delayed time.

6. Set up **Latching** in an alarm situation.
7. Set the time for calibrating the progress alarm.
8. Click **Accept**.

The screenshot shows the Honeywell Midas S2 configuration interface for Gas/Alarm. The left sidebar has 'Set-up' expanded, with 'Gas/Alarm' selected. The main area contains the following fields and options:

- Gas Name:** H2 (dropdown)
- User Gas Name:** (empty text field)
- K-factor:** (empty text field, Range: 1-100)
- Range:** 0-100 ppm
- Alarm Level 1:** 100.00 ppm (Range: 1-100ppm), Normal (up) selected, Depletion (down) unselected.
- Alarm Level 2:** 100.00 ppm (Range: 100-200ppm), Normal (up) selected, Depletion (down) unselected.
- Dead band:** Enable (dropdown)
- Latching Alarms:** Enable (dropdown)

At the bottom right, there are three buttons: 'RESET TO DEFAULT', 'RESET', and 'ACCEPT'. A 'Save successful' message is displayed in a green box at the top right.

FIGURE 4 -3: Setup gas detection and alarms

4.7.7 Set up the fullscale

Go to Set-up > Fullscale

You can set the 4-20mA as follows:

- **Output 4 mA:** Set the gas concentration for 4mA.
- **Output 20 mA:** Set the gas concentration for 20mA.

4.7.8 Set up the relays

Go to Set-up > Relays

You can set the relays as follows:

- **Relay configuration:** Set the operation conditions for Relay 1,2,3.
- **Alarm relay:** Set whether to generate alarm relay.
- **Fault relay:** Set whether to generate a fault relay.
- **External relay configuration:** Set the operation conditions for External relay.
- **External fault relay:** Set whether to generate a external fault relay.

4.7.9 Set up faults

Set a Fault Occurrence

On the home page, select **Set-up > Faults**.

You can set the faults as follows:

- **Latching faults:** Set whether to perform latching when faults occur.
- **Maintenance:** Set whether to generate a fault for maintenance
- **Temperature:** Set whether to generate a fault for Temperature. This option is enabled if the Maintenance setting is allowed too.

4.7.10 Set a LIT

LIT calibration is required.

On the home page, select **Set-up > LIT**.

You can set the LIT as follows:

- LIT On/Off: On or Off the LIT function
- Test period: Set the Line Leak Test interval

4.7.11 Zero calibration

Perform Zero calibration.

1. On the home page, select **Calibration > Zero Calibration**, and then, click **Start**.
2. Wait until the gas reading is stable, and then click **Accept**.
3. On the Result window the status of zero calibration is displayed. Click **Finish**.

4.7.12 Span calibration

Perform an span calibration.

1. On the home page, select **Calibration > Span Calibration**.
2. On the Span calibration page, you can select the gas, the gas type, and the target concentration.
3. Click **Start** and then follow screen instructions.

4.7.13 Flow calibration

Calibrate the amount of gas entering the device.

On the home page, select **Calibration > Flow Calibration**, and then follow screen instructions. You can adjust setpoints, and sync setpoints.

4.7.14 Calibrate 4-20 mA

Perform a device's mA calibration.

1. On the home page, select **Calibration > 4-20mA Calibration**, and then click **Start**.
2. Increase or decrease the mA value, and then click **Next** to Zero calibration (4 mA).
3. Increase or decrease the mA value, and then click **Next** to calibrate the span (20mA).

4.7.15 Perform a LIT calibration

Ensure sample inlet tubing is done and tested tightening. We recommend implementing blocking test

1. On the home page, select **Calibration > LIT Calibration**.
2. click **Start**.

4.7.16 Perform a bump test

Perform a Bump test on diverse channels.

1. On the home page, select **Test > Bump Test**.
2. Click **Enter Bump Test Mode**.
3. Optional Step. You can click **Stop Bump Test** to cancel the procedure.

4.7.17 Perform an alarm or fault simulation

Simulate function for testing alarm faults.

1. On the home page, select **Test > Alarm/Fault Simulation**.
2. Select whether the simulation should be on an Alarm or a Instrument fault.
3. Click **Accept**.

4.7.18 Perform a 4-20mA test

Note: The 4-20 MA test may cause unexpected alarm activation. Only authorized operators should perform this task.

1. On the home page, select **Test > 4-20 mA Test**.
2. Click **Accept**.
3. Increase or decrease the mA value.
4. Click **Close**.

4.7.19 Perform the LIT

IMPORTANT: Gas monitoring is stopped for about some minutes under Inhibit mode.

1. On the home page, select **Test > LIT**.
2. Click **Accept**.

4.7.20 Inhibit mode

Enable or disable the inhibit state.

1. On the home page, select **Test > Inhibit**.
2. From the **Inhibit level** option, select **No inhibit** or **Inhibit**.
3. Select the **Inhibit timeout** in minutes.
4. Click **Accept**.

Midas S2 is a fully serviceable product designed with modular components that can be readily replaced by trained service personnel so as to minimize the time that the gas detector is not available.

External in-line air filters should be replaced every three months or more frequently if the system is sampling in environments that have high levels of particulate matter or very acidic / wet atmospheres. Similarly, the internal particulate filter should be replaced every two years or more frequently if the sample lines are prone to heavy contamination. Refer to the following table.

Every sensor cartridge is shipped with a 2 years warranty. All sensor cartridges are factory calibrated to traceable national standards before shipment to the end user.

Note that testing or calibrating with the wrong (incorrect, out of date, non-traceable) calibration gases, calibration equipment, methods or operating conditions can actually damage the sensor cartridge's lifetime and alter the calibration adversely. Only qualified calibration technicians should attempt to calibrate the Midas S2 gas detector.

The internal pump module is designed to operate for a minimum of 24 months and it is recommended that this pump module (part number Midas S2-A-007) be replaced every 2 years.

See the Gas Table for the correct filter requirement for your application.

TABLE 5 -1: Recommended maintenance schedule

Component	Frequency
Pump	2 years or as needed
External Sample Line Filter	Part Number 780248, every 3-6 months Part Number 1991-0147, every 3-6 months Part Number 1830-0055, every 3-6 months
LIT Check Valve	2 years or as needed
Leak Check	Leak Check every 6 months or after replacing any component.
Bump Test	6 months
Flow Calibration	Flow Calibrate after pump, internal and external filter replacement.

NOTE: Every sensor cartridge warranty: Typically, two years depending on the sensor type. The Bias battery will last only about six months. After replacement, allow at least a day for the cartridge to reach equilibrium.

5.1 Block Test

A blocking test allows you to more clearly check whether there's a leakage in the sampling line after installation with higher accuracy than a traditional test (preventing flow fault from occurring). If you implement a blocking test, the device automatically changes to inhibit mode and returns to the previous status after the test.

1. Implement Blocking test under **Test mode** (refer to Topic3.5: Testing)
2. Enter the blocking test mode to see the inhibit mark on the top of the screen.
3. Block the end of the sampling line and keep blocking until the test is over. The test result is displayed on the screen after a few minutes.
4. Open the end of the sampling line.
5. Press to return one step.

Note: The blocking test is conducted under test mode so the device does not generate a Fault code. But If you have a Fail result, there's a leakage somewhere. Please check the status and connection of the sampling line and try again.

5.2 Replace the Pump







BEFORE YOU BEGIN: We recommend turning the Midas S2 unit off before replacing the pump module. If you want to replace the pump module with the power on, please refer to the detector inhibiting outputs on Topic 3.5: Testing.

1. Turn the power off.
2. Open the front module releasing the pump door latch.
3. Lower the pump module handle.
4. Remove the pump module by pulling it forward off the main module, withholding the handle.
5. Push the new pump module gently until fully seated.
6. Lock the pump module handle again and close the front module.
7. Turn the power on and confirm the actual flow rate is valid and stable on the screen

NOTE: After replacing a new pump module, we recommend implementing the blocking test firmly and flow calibration if needed.

5.3 Sensor Replacement

From the Sensor Replacement menu, you can replace the sensor cartridge in automatic changed inhibit mode.

1. Go to the Monitoring mode.
2. Press  and select Sensor Replacement, and then press  to enter the menu.
3. Replace the Sensor cartridge.
4. Press  or  to scroll the options, and then press  to accept it.
5. Optional Step: Press  to cancel and return one step back.

Learn from about strategic information related to the Midas S2 Detector.

6.1 Calibration & Bump Test

All Midas S2 sensor cartridges are pre-calibrated by Honeywell Analytics using traceable gas standards and approved calibration methods to a proven ISO 9000 quality controlled procedure. The Midas S2 sensor cartridge design is very robust and resistant to long term drift; in fact in a normal operating environment it is possible to extend the calibration interval with Midas S2 up to 24 months (subject to local requirements concerning calibrations). This design feature is another element that supports Midas S2 as a long term cost effective gas detection solution. Honeywell recommends frequent bump testing to confirm performance.

NOTE: It is the sole responsibility of each user to determine their own calibration and bump test schedule based on their own safety assessments and understanding of local requirements.

Just before commissioning, each Midas S2 unit should be zero calibrated to ensure accuracy. It is recommended that the unit be powered with the cartridge installed for at least 30 minutes prior to conducting a zero calibration. A second zero calibration may be required after a 24 hour period which is dependent on the site conditions. O2 sensors are not zero calibrated but should be span gas calibrated. See the Gas Table for span gas calibration details. If the ambient condition in the area the detector is monitoring experiences a long-term change, it is necessary to perform a zero calibration to allow the unit to adjust to the new conditions.

NOTE: When performing a zero calibration, be sure that the area is free of the target gas and interfering gases (refer to the cartridge data sheets for further details), as the presence of a background gas will affect the ability for the detector to properly calibrate to the correct levels. If the sample area cannot be verified to be free of the target gas or cross-sensitive gases, use a cylinder of zero air to perform the calibration

Calibration of an electrochemical sensor cartridge is a relatively complex discipline to master and it is possible that in less ideal field conditions the calibration can be far less accurate than under laboratory conditions and therefore substantial inaccuracies can be introduced. In the absence of any formal calibration policy by the end user, it is preferable to retain the original factory calibration.

Care must be taken to ensure that the correct materials for an extractive application are obtained from reputable suppliers and are of proven quality and composition. Inappropriate calibration equipment will lead to under - or over-presenting the wrong concentration of gas to the sensor cartridge during the calibration period. Likewise contaminated or inadequately flushed tubing and other gas-wet surfaces can also introduce errors into the calibration process. Only qualified, trained personnel should attempt to perform gas calibrations; contact

your local Honeywell Service Representative for further details on calibration services. Testing should be performed at the end of the sample tube or at the detector with a short length of tubing. Applying gas with a short length (less than 5 feet/1.5 meters) of clean FEP tubing will give optimal results for confirming the accuracy and response time of the cartridge.

Applying gas at the end of the installed sample line will test the full system including the whole length of tubing. This will verify the integrity of the tubing. Sample line integrity can also be checked by performing a leak check. Note that there will be additional transport time due to the tubing length and conditioning the gas-wet surfaces.

Bump tests are also used as an approximate means to present a controlled gas release to the sensor cartridge in order to verify that the transmitter does respond accordingly. Bump testing is popular as typical experiences show that a smaller list of easier to handle gases can be used to provide functional tests on a wider range of gas types. In the absence of a formal calibration policy from the end user, Honeywell would recommend a minimum semi-annual schedule of at least one bump test per sensor with the appropriate test gas.

Bump testing may reduce sensor cartridge lifetime and the accuracy of the calibration if applied incorrectly or too frequently. Use only the target gas or the recommended bump test gas.

Zero calibration is a recommended procedure that should be performed periodically to improve the performance of the sensor. This is particularly important when the sensor is operating outside of normal environmental conditions (20°C, 50% rH).

The Gas Table indicates the recommended calibration or bump test gas for the Midas S2 sensor cartridges:

Consult with your Honeywell Analytics Service Representative for approved methods and materials before commencing calibrations and bump tests.

6.1.1 Bump test

A bump test is not intended to be an accurate calibration, but is used as a confidence check to ensure that the gas detection system is functional. Since some of the target gases are difficult to handle, bump testing often makes use of cross sensitivities so that more convenient gases can be used. In bump test mode, the Modbus/TCP outputs are not inhibited. Only the 4-20 mA and alarm outputs are inhibited. The bump gas test is a functional check only. Consult local guidelines for recommended best practices. Bump test concentrations are calculated to generate a minimum first alarm level response.

6.1.2 Preparation

Most of the test gases are highly toxic. It is essential that personnel using these toxic gases be trained in their use. Ensure that the test gas will be vented safely.

Applying test gas may cause alarm, fault or maintenance fault indications on the 4-20 mA loop, relays or digital outputs. Before starting a test, ensure that suitable steps have been taken to prevent these indications from triggering unwanted actions. The Midas S2 gas detector has a special mode for bump testing where the alarm outputs are inhibited.

6.1.3 Finishing

Wait for the gas reading to return to normal levels. This may take some time, especially if concentrations above the recommended levels have been used or if the test gas has been applied for an extended period of time.

Ensure that any latched faults or alarms that have been generated by the testing have been cleared.

Make sure that the gas detection system is fully restored to its normal operating state and that any control system overrides used during the testing have been removed.

The alarms generated by the testing will have created entries in the transmitter's history log.

6.1.4 Troubleshooting

If the test does not produce a satisfactory result, check the following points:

- Check the gas cylinder concentration and type are correct
- Check the expiration date of the cylinder.
- Check that there is sufficient gas left in the cylinder.
- Check that there are no leaks on the test system.
- Make sure that the tubing length is as short as possible and that there are no blockages.
- Make sure that the transmitter is not displaying a fault before the test is started.

6.2 Waste Electrical and Electronic Equipment (WEEE)

EU Directive 2012/19/EU



This symbol indicates that the product must not be disposed of as general industrial or domestic waste. This product should be disposed of through suitable WEEE disposal facilities. For more information about disposal of this product, contact your local authority, distributor or the manufacturer.

6.3 Troubleshooting and Fault Diagnosis

Code	Description	Condition	Recovery
M9	Simulated maintenance fault	The user has generated a simulated fault.	Reset simulated fault.
M10	Over Range	A large concentration has been detected. The Midas S2 requires independent confirmation that the gas hazard is gone.	Supply known clean air to the Midas S2 and clear this fault.
M11	User gas calibration expired.	The user-specified calibration interval has elapsed.	Perform zero and span calibrations. Increase span calibration period.
M13	Flow error.	Midas S2 can no longer regulate flow (high or low flow condition).	Check filters and pump. Check pressure at the inlet and outlet and assure they are within specification.
M14	RESERVED	-	-
M15	Temperature near limit.	The temperature is within 2 Celsius of the limits.	Check the installation environment.
M16	Baseline fault.	The sensor baseline has drifted.	Check for background gas concentration, temperature, or humidity fluctuations. Perform zero calibration. Replace cartridge.
M17	Inhibit timeout.	The transmitter has been in inhibit mode for too long.	Resume monitoring or increase the timeout value.
M93	LIT fail	Leakage on the sample line during LIT calibration or LIT test	Secure sample line leakage with a blocking test and check the connection of the sampling line. If there is no leakage, service or replace the main module.
M94	LIT pump error	The pressure sensor does not work properly	Service or replace the main module.
F39	Simulated fault	The user has generated a simulated fault.	Reset simulated fault.
F40	RESERVED	-	-
F41	Baseline fault.	The sensor baseline has drifted.	Check for background gas concentration, temperature, or humidity fluctuations. Replace cartridge.
F42	Calibration expired.	Too long since the last calibration.	Replace or calibrate the cartridge.
F43	Cartridge expired.	The cartridge needs to be updated.	Replace cartridge.
F44	Cell failure.	Cartridge failed the Reflex™ check.- ECC. Cartridge failed the CAT check.- FL/IR	Replace cartridge.
F45	RESERVED	-	-
F46	Cartridge analog failure.	Electronic Failure.	Replace cartridge.
F47	Cartridge memory invalid.	Checksum error.	Replace cartridge.

Code	Description	Condition	Recovery
F48	Cartridge absent.	No sensor cartridge was detected.	Reseat cartridge. Replace cartridge
F49	The cartridge is replaced. No sensor cart?	The cartridge type was found to be incorrect after boot-up.	Replace the cartridge or press '3' and accept if correct.
F50	Cartridge comm. failed	The cartridge is detected, but no responding	Replace cartridge.
F51	The dummy cell is not installed.		Plug in the dummy cell.
F70	Transmitter program CRC error.	The transmitter is defective.	Service or replace Midas S2.
F71	Transmitter EEPROM CRC error.	The transmitter is defective.	Service or replace Midas S2.
F72	Transmitter supply voltage fail	The transmitter is defective.	Service or replace Midas S2.
F73	Transmitter's internal voltage fail	The transmitter is defective.	Service or replace Midas S2.
F80	Temperature limits exceeded.	Temperature is outside the limits	Check the installation environment.
F81	Gas inlet flow rate fail	Flow < 70% nominal for 60 seconds.	Check filters. Check for kinked tubing. Replace pump.
F82	RESERVED	RESERVED	RESERVED
F83	Pyrolyzer fail	Pyrolyzer fails to heat	Check the electrical connection to the Pyrolyzer. Replace Pyrolyzer.
F84	Misc. transmitter fault.	The transmitter is defective.	Service or replace Midas S2
F86	RESERVED	-	-
F87	RESERVED	-	-
F88	Pyrolyzer heater fail	The temperature of the Pyrolyzer is too high or low.	Service or replace the Pyrolyzer.
F89	RESERVED	-	-
F90	RESERVED	-	-
F91	Pyrolyzer installation fault	Pyrolyzer is not installed properly	Check gas type or reinstall the Pyrolyzer.
F92	NP1 pyrolyzer module failure		Check flow connections between Midas S2 and NP1 Pyrolyzer.

6.4 Specifications

Transmitter Dimension	
Size (unit with Cartridge)	138.6 (H) x 55 (W) x 148 (D) mm (5.46 x 2.17 x 5.83 in)
Weight - Transmitter	1.03kg (2.27lb)
Weight - Sensor cartridge	34~73 g (0.075~0.161 lb) dependent on sensor type
Power Requirements	
Operating Voltage	24 VDC Nominal, -15 to +10% (20.4 to 26.4 VDC)
Operating Voltage with Power over Ethernet (PoE)	48 VDC PoE (IEEE 802.3af compliant)
Power Consumption	
Transmitter unit	Toxic <4W, LEL <5.5W
Transmitter unit with optional module	NDIR <4.5W, Pyrolyzer < 12.95W
Outputs	
Visuals	Power, Alarm, Fault LEDs and color TFT LCD
Relays	Alarm1, Alarm2, Fault relay rated 1.0A@30VDC or 0.5A@125VAC max
Analog	Sink/Source, 4-20mA
Digital Communications	Modbus/TCP Ethernet/Power over Ethernet (PoE)
Display	
Size/color	2.4inch IPS panel with 16.7M display color
Viewing angle	160 or higher degree viewing angle
Operation key	4-button interface keypad
Transport System	
Flow Rate	Typically 500 mL/min
Sample Line Tubing	3.18mm ID X 6.35mm OD (0.125 X 0.25in)
Sample line Length	Up to 30 m (100 ft) with FEP tubing
Exhaust Line Tubing	4.76 mm ID X 6.35 mm OD (0.188 X 0.25 in)
Exhaust Length	Up to 30 m (100 ft)
Ambient Point	In line air filter required
Environmental	
Operating temperature	0°C to +40°C (32°F to 104°F) 0°C to +30°C (32°F to 86°F) with Pyrolyzer
Condition	Indoor only
Overvoltage	Category 1
Pollution degree	2

6.5 Ordering

Transmitter

Midas S2-T-004	Midas S2 Extractive Transmitter with Tube
Midas S2-T-006	Midas S2 Extractive Transmitter
Midas S2-T-L004	Midas S2 Extractive Transmitter with Tube - LIT
Midas S2-T-L006	Midas S2 Extractive Transmitter - LIT

Sensor cartridge

MIDAS S2-E-LEL	MIDAS S2-E-LEL sensor cartridge : CH4, H2, C2H4, C3H6
MIDAS S2-E-NH3	Midas S2 NH3 sensor cartridge : NH3
MIDAS S2-E-HCL	Midas S2 HCL sensor cartridge : BCl3, SiH2Cl2, HBr, HCl
MIDAS S2-E-H2X	Midas S2 H2X sensor cartridge : H2
MIDAS S2-E-COX	Midas S2 COX sensor cartridge : CO
MIDAS S2-E-COH	Midas S2 COH sensor cartridge : CO
MIDAS S2-E-XHF	Midas S2 XHF sensor cartridge : NF3, CH3F
MIDAS S2-E-SHX	Midas S2 SHX sensor cartridge : SiH4, Si2H6
MIDAS S2-E-HAL	Midas S2 HAL sensor cartridge : Cl2
MIDAS S2-E-O3X	Midas S2 O3X sensor cartridge : O3
MIDAS S2-E-HFX	Midas S2 HFX sensor cartridge : HF, BF3, WF6
Midas S2-E-SO2	Midas S2 SO2 sensor cartridge : SO2
Midas S2-E-H2S	Midas S2 H2S sensor cartridge : H2S
Midas S2-D-NDI	Midas S2 NDIR Dummy cartridge
Midas S2-I-COS	Midas S2 NDIR COS sensor cartridge : COS
Midas S2-I-C4F	Midas S2 NDIR C4F6 sensor cartridge : C4F6

Accessories

Midas S2-M01	Midas S2 main module
Midas S2-B01	Midas S2 base module
Midas S2-FRT	Midas S2 front module
Midas S2-A-007	Midas S2 pump module
Midas S2-AGB	Midas S2 angle bracket
Midas-A-010	replacement RF45 restraining strap
Midas-A-011	PoE ethernet injector
MIDAS-A-036	DIN rail mounting kit for Midas Transmitter or LonWorks® Interface Module
MM-LIT	Midas-M Check valve - LIT
1283K1090	Sample Line Tubing Duct Adapter
0235-0128	Flexible Conduit 21" (0.53 m) - length
0235-0163	Flexible Conduit 27" (0.68 m) - length
0235-0095	Union Fitting 1/4" tube, use to connect disposable filter to end of line, PP
0235-1072	Replacement "Corrosive" Filter elements (pk 100) For use in 1830-0055 filter housing
780248	End of line particulate filter
1830-0080	Freon/IPA Filter Extended Life (for NF3 pyrolyzing gas detector and IPA filter)
1830-0027	Freon/IPA Filter (for NF3 pyrolyzing gas detector and IPA filter)
1830-0055	Filter housing for end of Line particulate Filter for corrosive Gases, Reusable. Replaceable filter element (P/N 0235-1072) purchased separately
1991-0147	End of line particulate filter for Corrosive Gases, Disposable.
102599	Tubing Teflon® FEP 1/4" OD x 1/8" ID (Sample inlet) (Price per Foot)
1991-0136	Tubing Teflon® FEP 1/4" OD x 1/8" ID (Sample inlet) (100' continuous length)
100440	Tubing Polypropylene 1/4" OD x 3/16" ID (Exhaust) (Price per Foot)
1991-0137	Tubing Polypropylene 1/4" OD x 3/16" ID (Exhaust) (100' continuous length)
MVIP3632-2A	2A 24VDC power supply in vented NEMA 4 enclosure
MVIP3632-5A	5A 24VDC power supply in vented NEMA 4 enclosure

6.6 Gas Table

Gas name	Formular	Unit	Range(Unit)	LDL	Resolution	Default A1(Unit)	Default A2(Unit)	Sensor Part Number	Maximum Sensor Warm-up(Min.)	*Sensor Cartridge ID	*Gas ID	Calibration		Bump Test		Recommended Maximum Sample Line Length(m)	End of Line Filter
												Calibration Gas	Exp Time(Sec.)	Recommended Bump Test Gas	Max. Time(Sec.)		
Methane ⁷	CH4	LEL	0-100 ¹	3	0.5	10	20	Midas S2-E-LEL ⁸	30	25	2	CH4 2.5% vol	300	CH4 2.5% vol	300	30	780248, 1991-0147 or 1830-0055
Hydrogen ⁷	H2	LEL	0-100 ¹	3	0.5	10	20	Midas S2-E-LEL ⁸	30	25	1	H2 2% vol	300	CH4 2.5% vol	300	30	780248, 1991-0147 or 1830-0055
Ethylene	C2H4	LEL	0-100	3	0.5	10	20	Midas S2-E-LEL	30	25	5	C2H4 1.35% vol	300	CH4 2.5% vol	300	30	780248, 1991-0147 or 1830-0055
Propylene	C3H6	LEL	0-100	3	0.5	10	20	Midas S2-E-LEL	30	25	6	C3H6 1% vol	300	CH4 2.5% vol	300	30	780248, 1991-0147 or 1830-0055
Hydrogen Chloride	HCl	ppm	0-8	0.24	0.05	1	2	Midas S2-E-HCL	10	10	1	HCl 4 ppm	300	HCl 4 ppm	300	5 ⁴	1991-0147 or 1830-0055
Boron Trichloride	BCl3	ppm	0-8	0.24	0.05	1	2	Midas S2-E-HCL	10	10	2	BCl3 4 ppm	300	HCl 4 ppm	300	5 ⁴	1991-0147 or 1830-0055
Dichlorosilane	SiH2Cl2	ppm	0-8	0.24	0.05	1	2	Midas S2-E-HCL	10	10	3	SiH2Cl2 4 ppm	300	HCl 4 ppm	300	5 ⁴	1991-0147 or 1830-0055
Hydrogen Bromide	HBr	ppm	0-8	0.24	0.05	1	2	Midas S2-E-HCL	10	10	4	HBr 4 ppm	300	HCl 4 ppm	300	5 ⁴	1991-0147 or 1830-0055
Ammonia	NH3	ppm	0-100	9	0.5	12.5	25	Midas S2-E-NH3	10	1	1	NH3 50 ppm	300	NH3 50 ppm	300	10	780248, 1991-0147 or 1830-0055
Ozone	O3	ppm	0-0.4	0.036	0.002	0.05	0.1	Midas S2-E-O3X	10	22	1	O3 0.2 ppm	300	O3 0.2 ppm	300	10	1991-0147 or 1830-0055
Chlorine	Cl2	ppm	0-2	0.18	0.01	0.25	0.5	Midas S2-E-HAL	10	12	1	Cl2 1 ppm	300	Cl2 1 ppm	300	10	780248, 1991-0147 or 1830-0055
Hydrogen	H2	ppm	0-1000	90	5	125	250	Midas S2-E-H2X	10	16	1	H2 500 ppm	300	H2 500 ppm	300	30	780248, 1991-0147 or 1830-0055
Silane	SiH4	ppm	0-20	1.8	0.1	2.5	5	Midas S2-E-SHX	10	5	1	SiH4 10 ppm	300	SiH4 10 ppm	300	30	780248, 1991-0147 or 1830-0055

Gas name	Formular	Unit	Range(Unit)	LDL	Resolution	Default A1(Unit)	Default A2(Unit)	Sensor Part Number	Maximum Sensor Warm-up(Min.)	*Sensor Cartridge ID	*Gas ID	Calibration		Bump Test		Recommended Maximum Sample Line Length(m)	End of Line Filter
												Calibration Gas	Exp Time(Sec.)	Recommended Bump Test Gas	Max. Time(Sec.)		
Disilane	Si2H6	ppm	0-20	1.8	0.1	2.5	5	Midas S2-E-SHX	10	5	2	Si2H6 10 ppm	300	SiH4 10 ppm	300	30	780248, 1991-0147 or 1830-0055
Hydrogen Fluoride	HF	ppm	0-12	1.05	0.05	1.5	3	Midas S2-E-HFX	10	8	1	HF 6 ppm	300	HF 6 ppm	300	5 ⁴	1991-0147 or 1830-0055
Boron Trifluoride	BF3	ppm	0-8	0.88	0.05	1	2	Midas S2-E-HFX	10	8	2	BF3 4 ppm	300	HF 6 ppm	300	5 ⁴	1991-0147 or 1830-0055
Tungsten Hexafluoride	WF3	ppm	0-12	1.05	0.05	1.5	3	Midas S2-E-HFX	10	8	4	WF6 6 ppm	300	HF 6 ppm	300	5 ⁴	1991-0147 or 1830-0055
Carbon Monoxide	CO	ppm	0-100	9	0.5	12.5	25	Midas S2-E-COX	10	15	1	CO 50 ppm	300	CO 50 ppm	300	30	780248, 1991-0147 or 1830-0055
Carbon Monoxide(low H2 interference)	CO	ppm	0-100	9	0.5	12.5	25	Midas S2-E-COH	10	42	1	CO 50 ppm	300	CO 50 ppm	300	30	780248, 1991-0147 or 1830-0055
Hydrogen Fluoride	HF	ppm	0-12	1.05	0.05	1.5	3	Midas S2-E-XHF	10	34	1	HF 6 ppm	300	HF 6 ppm	300	5	1991-0147 or 1830-0055
Nitrogen Trifluoride	NF3	ppm	0-40	3.6	0.2	5	10	Midas S2-E-XHF	10 ³	34	2	HF 6 ppm ²	300	HF 6 ppm ²	300	30	780248, 1991-0147 or 1830-0055, 1830-0027 ^{5,6}
Methyl Fluoride	CH3F	ppm	0-120	8	0.5	15	30	Midas S2-E-XHF	10 ³	34	3	HF 6 ppm ²	300	HF 6 ppm ²	300	30	780248, 1991-0147 or 1830-0055
Sulfur Dioxide	SO2	ppm	0-8	0.7	0.05	1	2	Midas S2-E-SO2	10	23	1	SO2 4 ppm	300	SO2 4 ppm	300	30	780248, 1991-0147 or 1830-0055
Hydrogen Sulfide	H2S	ppm	0-40	3.6	0.2	5	10	Midas S2-E-H2S	10	18	1	H2S 20 ppm	300	H2S 20 ppm	300	30	780248, 1991-0147 or 1830-0055
Carbonyl Sulfide	COS	ppm	0-20	3	1	5	10	Midas S2-I-COS	10	81	1	COS 10 ppm	300	COS 10 ppm	300	30	780248, 1991-0147 or 1830-0055
Hexafluorobutadiene	C4F6	ppm	0-100	5	1	10	20	Midas S2-I-C4F6	10	82	1	C4F6 50ppm	300	C4F6 50ppm	300	30	780248, 1991-0147 or 1830-0055

General Notes:

1 Midas S2 detectors are not ETL approved for monitoring in or sampling from classified areas above %25 LEL.

2 End-of-line particulate filter (780248) MUST be removed when Pyrolyzer unit is calibrated/ bump tested with recommended gases other than target gases.

3 The Pyrolyzer unit requires a longer warmup time and a humidifier must be added in the sample line when a dry calibration gas is applied to the detector directly from a target gas cylinder

4 Recommended to keep the sample lines as short as possible where the RH condition at the sample point is high (above %50 RH); there will be some sample loss due to absorption onto the sample line.

5 When calibrating or bump testing NF3, sensor cartridges with Cl2, or HF, the charcoal Freon filter (1830-0027) MUST be removed for calibration/bump testing then reinstalled for monitoring.

6 Freon filter (1830-0027) is required for this application.

7 The most common failure in catalytic sensors is performance degradation caused by exposure to certain poisons' (referred to as Catalytic Poisons). It is therefore essential that any catalytic based gas monitoring system should be checked regularly via bump tested (or re-calibrated), more importantly after any gas release notification when there is a potential poisoning based gases may be present. For further details contact Honeywell Analytics (please ensure all gases that are potentially present in the area of detection are available prior to contacting)

8 MIDAS S2-E-LEL cartridge carries the standard 2 years warranty but can be calibrated to extend its life to 5 years. For the 2 years cartridges, Honeywell Analytics allows for a period of up to 6 months after the manufactured date for cartridge installation and then 2 years of use. If, for example, the cartridge is installed within the first 6 months, the expiration date will be 2 years after the installation date. If, however, the cartridge is installed more than 6 months after the manufactured date, it will expire 2.5 years after the manufactured date. Contact your local Honeywell Analytics Service Representative for more information.

Bump Testing Notes:

1. Use a concentration of 2 ppm.

IMPORTANT: This should only be done once to avoid the danger of poisoning the sensor. Contact the local Honeywell service representative for more information.

2. The ambient Oxygen level is typically %20.9 by volume. If there is a serious problem with an Oxygen sensor, the reading will not be %20.9. The flow rate is regulated by the Midas S2 unit.

CO₂, test gases must be in a balance of air, not Nitrogen.

As an alternative, the actual target gas can always be used instead of a cross-sensitive gas.

Higher concentrations than the recommended ones can be used if necessary, but extra time may be needed for the reading to recover to zero.

IMPORTANT: Do not exceed the recommended concentrations or application times where Hydrogen Sulfide is used to test Silane. Doing this can damage the cell.

6.7 Reflex

Midas S2 uses patented Honeywell technology to continuously monitor the health check status of specific electrochemical cells and alert the user if a cell enters a variety of fault conditions (such as open or short circuit etc.) which would leave the cell unable to detect gas and raise an appropriate alarm signal.

REFLEX® overcomes this unseen failure mode by applying periodically a special electronic pulse to the cell and reviewing the 'echo' from the cell as it responds to the applied signal. If the cell is deteriorating within certain pre-set limits based on the received signals then Midas S2 will decrease the REFLEX sampling interval in order to establish the actual viability of the cell. Within a relatively short time, Midas S2 will be able to alert the user via fault codes that the electrochemical cell is likely to be requiring replacement and is possibly unable to correctly detect gas.

REFLEX is not required for pellistors, IR, oxygen electrochemical cell or bias electrochemical cell as these sensor cartridges provide alternative electronic means to indicate open circuits and other sensor cartridge damage issues.

6.8 A Modbus/TCP Interface

The Midas S2 gas detector can report concentration information in a variety of formats including relay contact closure, an analog 4-20 mA loop, Ethernet/ IP/HTML web pages and via the Modbus/TCP networking protocol. This section defines the format of data in Modbus/TCP registers. More information about Modbus/TCP can be obtained from www.modbus.org.

The Midas S2 is a Modbus/TCP “server” as defined in the MODBUS Application Protocol Specification V1.0 . It supports command 03 (“read holding registers”) for registers 40001 to 40122 as listed in the following table.

The Midas S2 reports floating-point concentration numbers in little-endian or Intel format. This is scaled in units of ppm for gasses which have display units of ppm or ppb. For other display units the concentration is scaled directly in display units. This applies to registers Gas Concentration and Alarm Threshold.

The Midas S2 fills 122 Modbus/TCP holding registers as listed in the following table. The Monitoring Status register is a concise summary of Midas S2 status. The other registers provide more complete information.

TABLE 6 -1: Modbus Register map

Ref. Addr. Reg. Name	Bits	Function
40001 STTS Status		
nibble 0	0-3	Monitoring state integer
		0: Warmup
		1: Monitor mode with inhibit state "nonE"
		2: Monitor mode but alarms inhibited, inhibit state "ALm"
		3: Monitor mode but alarms and faults inhibited, inhibit state "AL-Ft"
		4: Monitor mode but fully Inhibited, inhibit state "ALL"
		5: Alarm / Fault Simulation
		6: Bump test mode (largely same as state 2)
		7: 4-20 mA loop Calibration mode
		8: Calibration Mode other than state 7
	9-15: for future expansion	
nibble1	4-5	Fault Status Integer
		0: No fault
		1: Maintenance fault active
		2: Instrument fault active
nibble2	6	Alarm1 active
	7	Alarm 2 active
	8	Relay 1 energized
	9	Relay 2 energized
nibble3	10	Relay 3 energized
	11	Heartbeat Bit - toggles every second to confirm communications
	12	Relays under remote Modbus/TCP control
	13	Last Zero Calibration Success
	14	Last Span Calibration Success
	15	for future expansion
40002 GASS Gas Selection		
	0-7	Gas ID
	8-15	iCartridgeType
40003 FCN1 Concentration in floating point format word1 of 2		
40004 FCN2 Concentration in floating point format word2 of 2		
40005 CONC Gas Concentration in Integer Format		
		Conversion equation: ppm value = Registry Value * 1/10 ^{DECP} When display units are ppm or ppb this will be scaled in ppm. For other display units this will be scaled in displayed units.
40006 NOFT Number of most important active fault		
40007 DPUN Decimal point and units		
	0-2	Decimal point indicator (0-3)
	3-7	for future expansion
	8-15	Concentration units
		1: ppm
		2: ppb
		4: % volume
		8: %LEL
		16: mA
		0,3,5,6,7,9-15,17-255: for future expansion
40008 TEMP Temperature in Celsius		
signed 16-bit integer		
40009 CLRH Cell life remaining in hours		
40010 HRTB Heartbeat Counter, 16 LSB of time in seconds		
40011 FLOW Sample flow rate in cc/minute		
40012 reserved for future expansion, currently zero		
40013 A1T1 Alarm 1 threshold in floating point format,		
40014 A1T2 scaling same as FCN1 and FCN2		
40015 A2T1 Alarm 2 threshold in floating point format,		
40016 A2T2 scaling same as FCN1 and FCN2		

Ref. Addr. Reg. Name	Bits	Function	
40017 ASI	0	Alarm1 active	
	1	Alarm2 active	
	12-15	Reserved for future expansion	
40018 FSI	0	Maintenance fault active	
	1	Instrument fault active	
	2	Flow fault active	
	3	Internal communication fault active	
	4	Pyrolyzer fault active	
	5	Sensor fault active	
	7-15	Reserved for future expansion	
40019 HST1		Concentration high scale in floating point format,	
40020 HST2		scaling same as FCN1 and FCN2	
40071 DSN1		Detector serial number in ASCII code format,	
40072 DSN2		maximum 10 characters (2 characters per each address)	
40073 DSN3			
40074 DSN4			
40075 DSN5			
40076 SSN1		Sensor serial number in ASCII code format,	
40077 SSN2		maximum 10 characters (2 characters per each address)	
40078 SSN3			
40079 SSN4			
40080 SSN5			
40081 MSI	0	Warm-up (STTS nibble0 value = 0)	
	1	Monitor mode (STTS nibble0 value = 1, 2, 3, 4)	
	2	Test mode (STTS nibble0 value = 5, 6)	
	3	Maintenance mode (STTS nibble0 value = 7, 8)	
	4-15	Reserved for future expansion	
40021 CMD1		user command register 1	
40022 CMD2		user command register 2	
	CMD1	CMD2	Functions
	0x015E	0x3626	reset alarms and faults
	0x025E	0x3626	Inhibit Alarms
	0x035E	0x3626	Inhibit Alarms and Faults
	0x045E	0x3626	Inhibit All
	0x055E	0x3626	No Inhibit
	0x065E	0x3626	Energize relay1
	0x075E	0x3626	De-energize relay1
	0x085E	0x3626	Energize relay2
	0x095E	0x3626	De-energize relay2
	0x0A5E	0x3626	Energize relay3
0x0B5E	0x3626	De-energize relay3	
Others	Others	ignored	
40023 to 40030		reserved for future expansion	
40082 DSN1		Detector serial number in ASCII code format,	
40083 DSN2		maximum 14 characters (2 characters per each address)	
40084 DSN3			
40085 DSN4			
40086 DSN5			
40087 DSN6			
40088 DSN7			
40089 SSN1		Sensor serial number in ASCII code format,	
40090 SSN2		maximum 14 characters (2 characters per each address)	
40091 SSN3			
40082 SSN4			
40093 SSN5			
40094 SSN6			
40095 SSN7			
40096 UGN1		Use gas name in ASCII code format,	
40097 UGN2		maximum 10 characters (2 characters per each address)	
40098 UGN3			
40099 UGN4			
40100 UGN5			
40061		Time reported by the Midas clock in UNIX format (seconds since 1970)	
40062		Time reported by the Midas clock in UNIX format (seconds since 1970)	
40063		Transmitter Serial Number Prefix (\$12345678, tempSerial[] only indicates the number) Prefix = (tempSerial[0] x 1000) + (tempSerial[1] x 100) + (tempSerial[2] x 10) + (tempSerial[3])	
40064		Transmitter Serial Number Surfix (\$12345678, tempSerial[] only indicates the number) Surfix = (tempSerial[3] x 1000) + (tempSerial[4] x 100) + (tempSerial[5] x 10) + (tempSerial[6])	
40065		Zero Calibration Success Time reported by the Midas clock in UNIX format (seconds since 1970)	
40066		Zero Calibration Success Time reported by the Midas clock in UNIX format (seconds since 1970)	
40067		Span Calibration Success Time reported by the Midas clock in UNIX format (seconds since 1970)	
40068		Span Calibration Success Time reported by the Midas clock in UNIX format (seconds since 1970)	

Refer to the *Sensor Cartridge ID* and *Gas ID* columns (* marked) in Topic 6.6: Gas Table and Topic 6.3: Troubleshooting and Fault Diagnosis for Modbus registration. For further information, refer to the *3016M5001 MIDAS-M User Manual* or contact the Honeywell Service team.

6.9 Security

Midas S2 is shipped from the factory with security disabled. It is recommended to enable the security function for safe use of the device. If the security function is enabled, the web server can be accessed through HTTPS. And it is recommended to clear the browser cache to access the web server through HTTP after security is disabled.

6.9.1 Modbus TCP

The MODBUS protocol does not have any authentication and integrity checking function. So the bump-in-the wire solution is recommended using a network equipment with SSL VPN Firewall function to protect the Midas S2 from external attacks.

6.9.2 DOS attack

The web application may not work due to DoS attacks. The Midas device is even needed to restart for the web application to work properly. So the bump-in-the wire solution is recommended using a network firewall hardware solution that can detect and block DoS attacks.

6.9.3 Install web server certificate in Google Chrome

How to install a web sever certificate in a Chrome web browser, when the security function is enabled.

1. Open Chrome browser window and type `https://xxx.xxx.xxx.xxx` (device address) as the URL, and then press **ENTER** to connect to the device. A "Connection to this site is not secure" message is displayed.
2. Click **Certificate** to download the certificate and follow onscreen instructions.
3. On the Chrome main page, click the three dots (Advanced) button and select **Settings > Manage certificates** and then follow onscreen instructions as follows to set the certificate.
4. Close and re-open the Chrome Web browser, and then access to your device's address `https://xxx.xxx.xxx.xxx`. A "Connection is secure" message is displayed. The certificate should be reinstalled when the IP address is changed

6.9.4 Install web server certificate in MS Browsers

How to install a web sever certificate in Microsoft Edge, when the security function is enabled.

1. Open browser window and access `https://xxx.xxx.xxx.xxx` (device address) in your browser. Click "Certificate error" text. The Certificate Information window is displayed.
2. Click **Export to File** and then save the certificate in your PC or device.
3. On your computer locate and run Certificate Manager `certmgr.msc`
4. On the Certificate Manager window, expand **Trusted Root Certification Authorities** and right click on **Certificates**. Select **All tasks > Import...**
5. Follow the Certificate Import Wizard onscreen instructions.

NOTE: The certificate should be reinstalled when the IP address is changed

6.10 Warranty

All products are designed and manufactured to the latest internationally recognized standards by Honeywell under a Quality Management System that is certified to ISO 9001.

As such, the Midas S2 Transmitter (including the pump) is warranted under proper use, to the original end- user purchaser, against any defects in materials or workmanship related failures for a **period of 12 months** from the date of first turn-on or 18 months from delivery from Honeywell Analytics to the customer, whichever is less. Separate warranty conditions apply to the sensor cartridges limited as indicated below. During this period, Honeywell Analytics will repair or replace defective parts on an exchange basis, F.O.B. to approved service centers on a global basis.

This warranty does not cover damage caused by accident, abuse, abnormal operating conditions or extreme poisoning of the sensor cartridge.

Defective equipment must be returned to Honeywell Analytics for repair. Before returning materials for repair or replacement, the Customer must obtain a Service Event Number (SE#) by contacting Honeywell Service in advance; include a detailed report stating the nature of the defect and ship the equipment prepaid to Honeywell Analytics' factory. If no detail report is included, Honeywell Analytics reserves the right to charge an investigative fee (prices available upon request) before any repair or replacement is performed. Returned goods must detail the Service Event Number (SE#) clearly on the package.

Service in the field or at the customer's premises is not covered under these warranty terms. Time and travel expenses for on-site warranty services will be charged at Honeywell Analytics' normal billing rates.

Contact your Honeywell representative for information on available Service Contracts.

Honeywell shall not be liable for any loss or damage whatsoever or howsoever occasioned which may be a direct or indirect result of the use or operation of the Contract Goods by the Buyer or any Party.

This warranty covers the gas detector and parts sold to the Buyer only by authorized distributors, dealers and representatives as appointed by Honeywell. This warranty does not cover defects attributable to improper installation, repair by an unauthorized person or the use of unauthorized accessories/parts on the product. A warranty claim will only be accepted if a proof of purchase is submitted and all conditions obtained within this Warranty are met.

Honeywell reserves the right to validate any warranty claim prior to processing. Upon acceptance of a warranty claim, Honeywell Analytics will repair or replace the defective product free of charge. The initial warranty period is not extended by virtue of any works carried out there after.

Instruments which have been repaired or replaced during the warranty period are warranted for the remainder of the unexpired portion of the original warranty period.

Honeywell is released from all obligations under its warranty in the event repairs or modifications are made by persons other than its own authorized personnel, unless such work is authorized in writing by Honeywell. The initial warranty period is not extended by virtue of any works carried out there under.

Honeywell reserves the right to change this policy at any time. Contact Honeywell for the most current warranty information.

6.10.1 Sensor Cartridges Warranty

Midas S2 sensor cartridges carry a warranty specified for each gas sensor in the sensor cartridge datasheet. The user should activate (install) before the marked Date on the cartridge. The warranty period is from switch-on/installation or "activation by" date, whichever is faster.

All sensor cartridges are guaranteed to operate satisfactorily for the period described above and will be replaced at no charge within that period only if it will not provide a correct reading after calibration by Authorized Service personnel. Physical or chemical damage, resulting from exposure to improper elements, is not covered.

Especially for combustible (LEL) sensor cartridges, this guarantee is void if it has been contaminated by some unusual substance, including but not limited to, water or other liquids, oily compounds, corrosives, silicones, lead vapors, extremely high concentrations of combustible gases, and various particulates which may inhibit gas flow to the sensor cartridge element.

Note that the Midas S2 sensor cartridge stores an electronic history of each individual sensor cartridge's manufacture, warranty and calibration activity that is accessible by Authorized Service personnel.

NOTE: If the customer breaks down the sensor cartridge by disassembling, modifying, careless use (physical and chemical damage), or other unauthorized alteration, the quality is not guaranteed and is excluded from the free replacement.

6.11 Contact Us

6.11.1 Europe, Middle East, Africa

Life Safety Distribution GmbH
Javastrasse 2, 8604 Hegnau
Switzerland
Tel: +41 (0)44 943 4300
gasdetection@honeywell.com

Customer service:

Toll-free: 00800 333 222 44

Tel: +41 (0)44 943 4380

Middle East Tel: +971 4 450 5800 (Fixed Gas Detection)

Middle East Tel: +971 4 450 5852 (Portable Gas Detection)

6.11.2 Asia Pacific

Honeywell Co., Ltd.
5F SangAm IT Tower
434, World Cup buk-ro, Mapo-gu
Seoul 03922 , Republic of Korea
Tel : +82(0) 2 6909 0300
India Tel: +91 124 4752700
China Tel: +86 10 5885 8788 3000
analytics.ap@honeywell.com

6.11.3 Americas

Honeywell Analytics Distribution Inc. 405 Barclay Blvd. Lincolnshire, IL 60069. USA
Tel: +1 847 955 8200
Toll-free: +1 800 538 0363
detectgas@honeywell.com
RAE Systems by Honeywell
Phone: 408.952.8200
Toll-Free: 1.888.723.4800

6.11.4 Technical Support

EMEA: gastechsupportemea@honeywell.com
Americas: is.gas.techsupport@honeywell.com
AP: gas.techsupport.apaci@honeywell.com
LATAM: SoporteTecnico.HGAS@Honeywell.com
Brazil: SuporteTecnico.HGAS@Honeywell.com

Midas® S2
User Manual3023M5001
Language: English
RevisionA
@ 2023
8/31/2023



Manuals and other information about this product are available at : sps.honeywell.com