



# MARWIN VALVE

3170 Wasson Road • Cincinnati, OH 45209 USA  
Phone 513-533-5600 • Fax 513-871-0105  
marwin@richardsind.com • www.marwinvalve.com

## I & M 3T3100/3L3200 Series

*Installation & Maintenance Instructions for  
Marwin 3T3100/3L3200 Series Three Way Ball Valves*

**Warning:** Marwin Valve ball valves must only be used, installed and repaired in accordance with these Installation & Maintenance Instructions. Observe all applicable public and company codes and regulations. In the event of leakage or other malfunction, call a qualified service person; continued operation may cause system failure or a general hazard.

### Please read these instructions carefully!

Your Marwin Valve product will provide you with long, trouble-free service if it is correctly installed and maintained. Spending a few minutes now reading these instructions can save hours of trouble and downtime later. When making repairs, use only genuine Marwin Valve parts, available for immediate shipment from the factory.

### Scope

This manual is intended as a guide to assist customers in the storage, installation, and maintenance of Marwin 3T3100/3L3200 Series three way ball valves. Subsequent additions or special instructions will be provided for special ball valves, critical service or customer requirements.

### Applicability

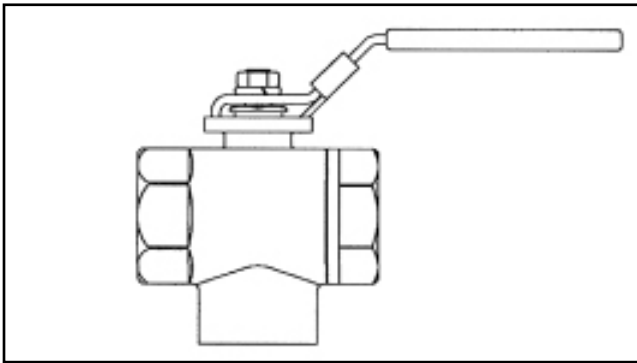

This manual is applicable to the 3T3100/3L3200 Series Marwin three way ball valves.

### Caution

1. Valve pressure ratings are based on many variables, including valve series and size, as well as body, seat and bolt material. Verify that application does not exceed the pressure or temperature rating on the nameplate.
2. Always depressurize the line with the valve in the OPEN position before disassembly. Cycle valve in

- depressurized line before removing valve.
3. Wear protective equipment and take appropriate precautions to safeguard against injury caused by the discharge of trapped fluids.
4. Use only Marwin recommended spare parts for maintenance.
5. To ensure safety and maintain warranty, never modify valve in any way without prior approval from Marwin.

### Storage

A petroleum-based oil (silicone free) is used as lubrication on all internal surfaces. This may be removed with a solvent if found objectionable. All valves are adequately packed in a strong cardboard case in such a way as to avoid any possible damage during transport and storage.

**Caution: if ball valves are not destined for immediate use, the following precautions should be taken:**

1. If possible, leave the ball valves in their packing cases during the period of storage.
2. Ball valves must remain in open position during this time.
3. In order to prevent damage, protective plastic covers on valve ends should not be removed until immediately prior to installation.
4. It is advisable to store the valves in waterproof conditions. Ball valves should be protected to safeguard against humidity, moisture, dust, dirt sand, mud, salt spray and seawater.
5. All valves complete with actuators are to be stored in dry conditions.
6. Valves to be stored for a long period of time should be checked by the quality control personnel every six months; every three months when valves are automated.

#### Maintenance During Storage Period

- Internal surface should be inspected to check for dust or other foreign objects.
- Rust or dust must be removed by cleaning with proper solvent.
- After cleaning, ball valves must be lubricated with an adequate lubricant.
- Ball valves should be operated for at least two complete cycles before installing or returning to storage.

---

## Installation

---

The ball valves may be installed in any position using standard pipe fitting practices.

Caution: Before installation of the valve:

1. Pipe must be free of tension both during and after installation.
2. Pipe must be flushed to clean dirt, welding residues, etc. which would damage ball or seats.
3. The valve should be kept in OPEN POSITION during installation and protective plastic covers must be removed only at the moment of installation.
4. Before shipment, the ball is lubricated with a pure Vaseline oil. This can be easily removed with an application compatible solvent if required.
5. If the valve was specified to be tested per ANSI 16.34, there may be some trapped water between the ball and the body cavity. This can be removed by partially opening the valve, thereby exposing the cavity to the through port of the ball.
6. Special care should always be taken when installing automated ball valves that the ball is in the proper position.

### ■ Installation of Threaded-Ends

1. Unless otherwise specified, pipe threads are American National Standard Taper Pipe Threads (NPT) per ANSI B1.20.1 and require that a pipe sealant be used.
2. Install valve using standard piping practices.
3. When tightening valve, apply wrench to the end cap nearest the pipe being worked on.

---

## Manual Operation

---

### ■ 3T3100 Series

The 3T3100 Series provides a “T” arrangement at the 0° and 180° position allowing flow in each direction. The 90° position provides a “T” arrangement, which allows flow from the bottom in both directions simultaneously. There is no stop at 90° position.



### ■ 3L3200 Series



The 3L3200 Series provides a “L” port arrangement at the 0° and 180° position allowing flow in each direction. Flow is shut off at the 90° position. There is no stop at the 90° position.

---

## Port Configuration

---

	A	B	C
BL1			
	0°	90°	180°

	A	B	C
BL3			
	0°	90°	180°

---

## Maintenance

---

Before starting maintenance, please read information contained in the *Caution Section* of the manual.

1. Operate the ball valve at least once to release the pressure completely from valve body.
2. Ball valves, if correctly used, normally do not need any internal lubrication and maintenance. However, when necessary, ball or seats can be replaced by qualified personnel following the instructions of this manual.

---

## Valve Disassembly

---

Note: The 3T3100/3L3200 Series ball valves are not designed for rebuilding, nor is it economical to do so. Should the valve leak, complete replacement is recommended.

---

## Troubleshooting

---

### A. Steam Leakage

You can eliminate leakage in the stem area by increasing the torque on the gland nut in one-quarter increments. If leakage persists, replace valve.

### B. Body Seal Leakage

Check the torque of the end cap. If leakage persists, replace valve.

### C. In Line or Seats Leakage

Check to be sure valve is in fully closed position. If leakage persists, the valve must be replaced.