

## PRESSURE, VACUUM, DIFFERENTIAL PRESSURE, TEMPERATURE



### FEATURES

- Epoxy Coated Type 4X Enclosure and Stainless Steel Component Parts
- Hermetically Sealed Snap Switch, SPDT or DPDT Output
- Terminal Block Wiring
- Tamper-Resistant Set Point "Lock"
- Adjustable Ranges:
  - "wc ranges: 300 "wc vacuum to 250 "wc pressure (-747 to 622 mbar)
  - Pressure: 30 "Hg Vac to 3500 psi (-1 to 241 bar)
  - Differential Pressure: 0.8 "wcd to 500 psid (2 mbar to 34.5 bar)
  - Temperature: -120 to 640°F (-85 to 338°C)



### OVERVIEW

Approved for Division 2 hazardous locations and corrosive atmospheres, the 117 Series can be used to measure vacuum, pressure, differential pressure or temperature in a variety of applications. Its compact, epoxy-coated enclosure and hermetically sealed snap switch provide superior corrosion resistance within the harshest environments. Popular sensors in a variety of materials are available, ranging from all welded stainless steel to elastomer diaphragms. Rugged, reliable and cost effective, the 117 Series is an ideal choice for the most demanding applications; typically wastewater treatment, pulp and paper mills, food and beverage plants, steel and aluminum mills, petrochemical, and pharmaceutical plants.

### FEATURES

- Approved for Division 2 hazardous locations
- Optional ATEX or GOST intrinsic safety compliance
- Hermetically sealed snap switch, SPDT or DPDT output
- Welded stainless steel diaphragms
- Optional sensor material for corrosive media
- Ultra-low pressure ranges
- Polished stainless steel flush mount sensors

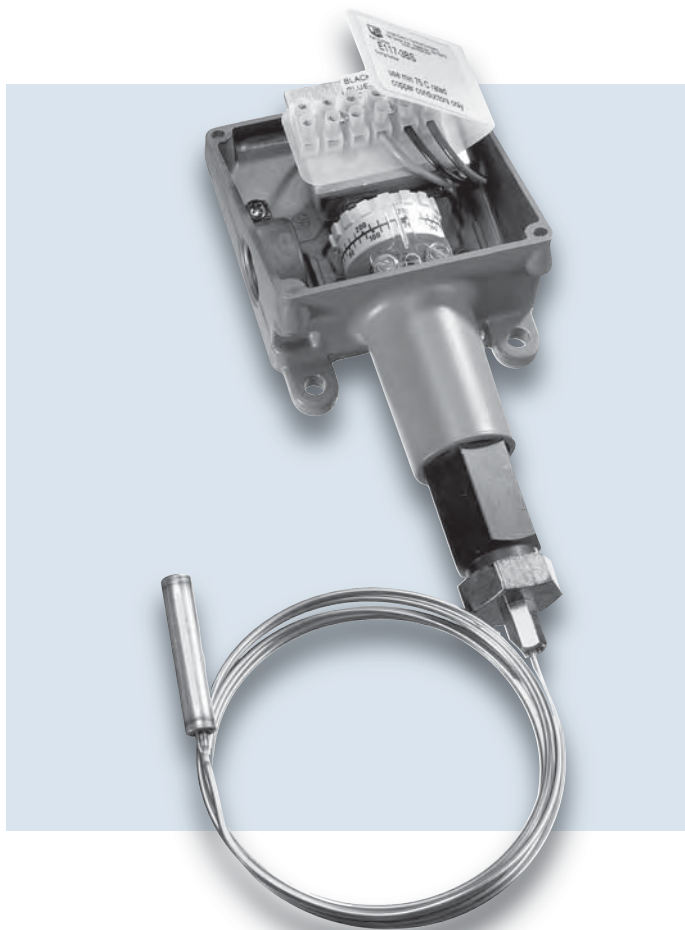

## SPECIFICATIONS

<b>STORAGE TEMPERATURE</b>	-65° to 160°F (-54 to 71 °C)
<b>AMBIENT TEMPERATURE LIMITS</b>	-40° to 160°F (-40° to 71 °C); except models 520-525, 540-548, 700-706: 0 to 160°F (-18 to 71 °C); set point typically shifts less than 1% of range for a 50°F (28°C) ambient temperature change
<b>SET POINT REPEATABILITY</b>	Temperature models: ± 1% of adjustable range Pressure models 171-174, 218, 358-376, 520-535, 540-543, 560-564 and 700-706: ± 1% of adjustable range; models 183-194, 544-548, 483-494, 565-567: ± 1.5% of adjustable range Internal set point lock on all pressure models
<b>SHOCK</b>	Set point repeats after 15 G, 10 millisecond duration
<b>VIBRATION</b>	Set point repeats after 2.5 G, 5-500 Hz
<b>ENCLOSURE</b>	Die cast aluminum, epoxy powder coated, gasketed; captive cover screws; stainless steel nameplate
<b>ENCLOSURE CLASSIFICATION</b>	Enclosure Type 4X
<b>SWITCH OUTPUT</b>	One SPDT hermetically sealed snap action switch; switch may be wired "normally open" or "normally closed"; DPDT (option 1190/1195)
<b>ELECTRICAL RATING</b>	11 A 125/250 VAC resistive; 5 A @ 28 VDC; 1 A @ 48 VDC; 1/2 A @ 125 VDC; switch contacts gold flashed
<b>WEIGHT</b>	1.5-6.5 lbs. Varies with model
<b>ELECTRICAL CONNECTION</b>	1/2" NPT (female); two 7/8" diameter knockouts
<b>PRESSURE CONNECTION</b>	Models 218, 358-376, 700-706: 1/4" NPT (female); models 171-194, 483-494, 520-535: 1/2" NPT (female); models 560-564: 2" sanitary connection; models 565-567: 1.5" sanitary connection, models 540-548: 1/8" NPT (female)
<b>TEMPERATURE ASSEMBLY</b>	Bulb and capillary: 6 feet; 304 stainless steel Immersion stem: nickel-plated brass (standard length only); optional 316L stainless steel
<b>FILL</b>	Non-toxic oil filled
<b>TEMPERATURE DEADBAND</b>	Typically 4% of range under laboratory conditions (70°F ambient circulating bath at rate of 1/2°F per minute change)
<b>REFERENCE SCALE</b>	Pressure: "Low-Medium-High" increment Temperature: Calibrated dial scale



# 117 Series

117 Series

## APPROVALS



### UNITED STATES AND CANADA

UL Listed, cUL Certified  
Class I, Division 2, Groups A, B, C & D  
Class II, Division 2, Groups F & G  
Class III



Enclosure Type 4X  
Pressure: UL 508 & 1604; CSA C22.2 No. 14  
& 213 - File # E40857



Temperature: UL 508 & 1604; CSA C22.2 No. 24  
& 213 - File # E43374

### EUROPEAN UNION

#### ATEX Directive 94/9/EC

II 1 G EEx ia IIC T6 (OPTIONAL - code M405)

Tamb = -50C to +60C  
UL International DEMKO A/S (N.B.# 0539)  
Certificate # DEMKO 03 ATEX 0335063  
EN 50014, 50020 & 50284

#### Pressure Equipment Directive (PED) 97/23/EC

Gage pressure models only  
Category IV, Module H1 (OPTIONAL - code M407)  
TÜV Industrie Service, TÜV SÜD AG (N.B.# 0036)  
Certificate # USA 02/04/38/001 thru USA  
02/07/38/033

### Low Voltage Directive (LVD) 73/23/EC & 93/68/EEC

Compliant to LVD  
Products rated lower than 50 VAC and 75 VDC are outside the scope of the LVD  
The Low Voltage Directive does not apply to products for use in hazardous locations



### RUSSIA

Gosgortekhnadzor Permit (OPTIONAL - code M406)

0ExialICT6  
Tamb = -50C to +60C  
NANIO CCVE Certification Center  
Certificate # RRS 04-8897  
GOST 12.2.007.0, GOST R 51330.0 & 51330.10

## PRESSURE MODEL CHART

Model	Adjustable Set Point Range		Deadband		*Over Range Pressure		**Proof Pressure	
	Low end of range on fall; High end of range on rise							
Type H117	"wc	mbar	"wc	mbar	psi	bar	psi	bar
Buna N diaphragm and O-ring with epoxy coated aluminum 1/2" NPT (female) pressure connection; large 0.72" orifice for clean-out purposes (Other wetted materials available - see page 9)								
520	300 Vac to 0	-746,7 to 0	0.8 to 32	2,0 to 79,6	200	13,8	400	27,6
521	10 Vac to 10	-24,9 to 24,9	0.4 to 2.4	1,0 to 6,0	200	13,8	400	27,6
522	50 Vac to 50	-124,5 to 124,5	0.4 to 12	1,0 to 29,9	200	13,8	400	27,6
523	0.5 to 5	1,2 to 12,4	0.4 to 1.2	1,0 to 3,0	200	13,8	400	27,6
524	2.5 to 50	6,2 to 124,5	0.4 to 3.2	1,0 to 8,0	200	13,8	400	27,6
525	10 to 250	24,9 to 622,3	0.4 to 24	1,0 to 59,7	200	13,8	400	27,6
Welded 316L stainless steel diaphragm and 1/2" NPT (female) pressure connection, large 0.72" orifice for clean-out purposes								
530	300 Vac to 0	-746,7 to 0	0.8 to 60	2,0 to 149,3	50	3,4	100	6,9
531	10 Vac to 10	-24,9 to 24,9	0.4 to 2.4	1,0 to 6,0	50	3,4	100	6,9
532	50 Vac to 50	-124,5 to 124,5	0.4 to 12	1,0 to 29,9	50	3,4	100	6,9
533	0.5 to 5	1,2 to 12,4	0.4 to 1.2	1,0 to 3,0	50	3,4	100	6,9
534	2.5 to 50	6,2 to 124,5	0.4 to 3.2	1,0 to 8,0	50	3,4	100	6,9
535	10 to 250	24,9 to 622,3	0.4 to 40	1,0 to 99,6	50	3,4	100	6,9

\*Over Range Pressure: The maximum pressure that may be applied continuously without causing damage and maintaining set point repeatability.

\*\* Proof Pressure: The maximum pressure to which a pressure sensor may be occasionally subjected, which causes no permanent damage. The unit may require calibration (e.g. start-up, testing).

Model	Adjustable Set Point Range		Deadband		*Over Range Pressure		**Proof Pressure	
	Low end of range on fall; High end of range on rise							
Type H117	psi	bar (unless noted)	psi	bar (unless noted)	psi	bar	psi	bar
2" sanitary welded 316L stainless steel diaphragm and pressure connection. Mates with Tri-Clamp® fitting systems (not UE supplied)								
560	1 to 15	68,9 mbar to 1 bar	0.3 to 3	20,7 mbar to 0,2	200	13,8	300	20,7
561	1 to 25	68,9 mbar to 1 bar	0.3 to 4.5	20,7 mbar to 0,3	200	13,8	300	20,7
562	2 to 50	0,1 to 3,4	0.3 to 7.5	20,7 mbar to 0,5	200	13,8	300	20,7
563	4 to 100	0,3 to 6,9	0.3 to 12	20,7 mbar to 0,8	200	13,8	300	20,7
564	8 to 200	0,6 to 13,8	0.3 to 15	20,7 mbar to 1	200	13,8	300	20,7
1.5" sanitary welded 316L stainless steel diaphragm and pressure connection. Mates with Tri-Clamp® fitting systems (not UE supplied)								
565	5 to 30	0,3 to 2,1	3 to 15	0,2 to 1,0	1000	68,9	1500	103,4
566	10 to 100	0,7 to 6,9	3 to 36	0,2 to 2,5	1000	68,9	1500	103,4
567	15 to 300	1,0 to 20,7	9 to 66	0,6 to 4,6	1000	68,9	1500	103,4
Welded 316L stainless steel diaphragm and 1/2" NPT (female) pressure connection, large 0.72" orifice for clean-out purposes; NACE MR-0175 compliant								
171	1 to 20	68,9 mbar to 1,4 bar	0.1 to 3	6,9 mbar to 0,2	500	34,5	1000	68,9
172	2 to 50	0,1 to 3,4	0.1 to 5	6,9 mbar to 0,3	500	34,5	1000	68,9
173	4 to 100	0,3 to 6,9	0.1 to 10	6,9 mbar to 0,7	500	34,5	1000	68,9
174	8 to 200	0,6 to 13,8	0.1 to 15	6,9 mbar to 1,0	500	34,5	1000	68,9
316L stainless steel diaphragm (optional Hastelloy® C or Monel®); Viton® GLT O-ring (optional Kalrez®, Silicone, Ethylene Propylene, or Aflas®); 316 stainless steel 1/2" NPT (female) pressure connection (optional Hastelloy® C, or Monel®), large 0.72" orifice for clean-out purposes. Models 188 and 189 have a 316L stainless steel 1/2" NPT (female) pressure connection; NACE MR-0175 compliant								
183	1 to 20	0,1 to 1,4	0.3 to 5	20,7 mbar to 0,3	500	34,5	1000	68,9
184	2 to 50	0,1 to 3,4	0.3 to 6	20,7 mbar to 0,4	500	34,5	1000	68,9
185	4 to 100	0,3 to 6,9	0.5 to 10	34,5 mbar to 0,7	500	34,5	1000	68,9
186	8 to 200	0,6 to 13,8	0.5 to 17	34,5 mbar to 1,2	500	34,5	1000	68,9
188	50 to 1000	3,4 to 68,9	30 to 300	2,1 to 20,7	2000	137,9	7000	482,6
189	250 to 3500	17,2 to 241,3	50 to 500	3,4 to 34,5	4000	275,8	7000	482,6
316L stainless steel diaphragm (optional Hastelloy® C, or Monel®); Viton® GLT O-ring (optional Kalrez®, Silicone, Ethylene Propylene or Aflas®); 316 stainless steel 1/2" NPT (female) pressure connection (optional Hastelloy® C, or Monel®), 0.06" orifice to dampen pulsations. Models 488 and 489 have a 316L stainless steel 1/2" NPT (female) pressure connection; NACE MR-0175 compliant								
483	1 to 20	0,1 to 1,4	0.3 to 5	20,7 mbar to 0,3	500	34,5	1000	68,9
484	2 to 50	0,1 to 3,4	0.3 to 6	20,7 mbar to 0,4	500	34,5	1000	68,9
485	4 to 100	0,3 to 6,9	0.5 to 10	34,5 mbar to 0,7	500	34,5	1000	68,9
486	8 to 200	0,6 to 13,8	0.5 to 17	34,5 mbar to 1,2	500	34,5	1000	68,9
488	50 to 1000	3,4 to 68,9	30 to 300	2,1 to 20,7	2000	137,9	7000	482,6
489	250 to 3500	17,2 to 241,3	50 to 500	3,4 to 34,5	4000	275,8	7000	482,6

**Application Note:** The use of metallic diaphragms where higher pressure shock or heavy cycling is expected should be avoided. Models 171-174 should not be used where system or start-up vacuum pressure might exceed 26" Hg Vac (-0,9 bar). Use of optional diaphragm materials for models 483-489 may increase deadband.

**Hastelloy®** is a registered trademark of Haynes International, Inc.

**Monel®** is a registered trademark of the INCO family of companies

**Aflas®** is a registered trademark of Asahi Glass

**Viton® and Kalrez®** are registered trademarks of DuPont Dow Elastomers

**Tri-Clamp®** is a registered trademark of Tri-Clover, Inc.



# 117 Series

## 117 Series

### PRESSURE MODEL CHART

Model	Adjustable Set Point Range		Deadband			*Over Range Pressure		**Proof Pressure	
	Low end of range on fall; High end of range on rise								
Type H117	psi (unless noted)	bar	psi (unless noted)		bar (unless noted)	psi	bar	psi	bar
Phosphor bronze bellows with nickel-plated brass 1/4" NPT (female) pressure connection; 303 stainless steel spring exposed to media									
218 2,1	30 "Hg Vac to 0	-1 to 0	2 to 5 "Hg		67,7 to 169,3 mbar	0		0	30
Welded 316L stainless steel bellows and 1/4" NPT (female) pressure connection									
358	15 to 200	1,0 to 13,8	6 to 20		0,4 to 1,4	200	13,8	800	55,2
361	20 to 300	1,4 to 20,7	8 to 22		0,6 to 1,5	300	20,7	800	55,2
376	25 to 500	1,7 to 34,5	10 to 28		0,7 to 1,9	500	34,5	800	55,2
			Lower 75% range span	Top 25% range span	Lower 75% range span				
			psi (unless noted)	psi	bar				
Welded 316 stainless steel diaphragm and 1/2" NPT (female) pressure connection, large 0.72" orifice for clean-out purposes; NACE MR-0175 compliant									
190	5 to 30	0,3 to 2,1	3 to 8	10 max	0,2 to 0,6	1500	103,4	2500	172,4
191	10 to 100	0,7 to 6,9	3 to 30	45 max	0,2 to 2,1	1500	103,4	2500	172,4
192	15 to 300	1,0 to 20,7	10 to 40	60 max	0,7 to 2,8	1500	103,4	2500	172,4
193	20 to 500	1,4 to 34,5	15 to 45	75 max	1,0 to 3,1	1500	103,4	2500	172,4
194	80 to 1700	5,5 to 117,2	5 to 120	200 max	0,3 to 8,3	2000	137,9	2500	172,4
Welded 316 stainless steel diaphragm and 1/2" NPT (female) pressure connection, 0.06" orifice to dampen pulsations									
490	5 to 30	0,3 to 2,1	3 to 8	10 max	0,2 to 0,6	1500	103,4	2500	172,4
491	10 to 100	0,7 to 6,9	3 to 30	45 max	0,2 to 2,1	1500	103,4	2500	172,4
492	15 to 300	1,0 to 20,7	10 to 40	60 max	0,7 to 2,8	1500	103,4	2500	172,4
493	20 to 500	1,4 to 34,5	15 to 45	75 max	1,0 to 3,1	1500	103,4	2500	172,4
494	80 to 1700	5,5 to 117,2	5 to 120	200 max	0,3 to 8,3	2000	137,9	2500	172,4

**Deadband Notes:** Models 190-194, 490-494 are expressed as the lower 75% and top 25% of the range span because of the operating characteristics of the welded stainless steel diaphragm sensor and hermetically sealed switch.

**\*Over Range Pressure:** The maximum pressure that may be applied continuously without causing damage and maintaining set point repeatability.

**\*\* Proof Pressure:** The maximum pressure to which a pressure sensor may be occasionally subjected, which causes no permanent damage. The unit may require calibration (e.g. start-up, testing).

**\*\*\*Working Pressure Range:** The pressure range within which two opposing sensors can be safely operated and still maintain set point adjustability provided the difference in pressure between them does not exceed the designated adjustable range.

Model	Adjustable Set Point Range		Deadband		*Over Range Pressure		**Proof Pressure	
	Low end of range on fall; High end of range on rise							
Type H117	psi	bar	psi	bar	psi	bar	psi	bar
Buna N diaphragm and O-ring with 303 stainless steel 1/4" NPT (female) pressure connection; option M540 Viton® diaphragm and O-ring available								
700	3 to 20	0,2 to 1,4	1,0 to 4	0,1 to 0,3	500	34,5	1000	68,9
702	3 to 100	0,2 to 6,9	2 to 12	0,1 to 0,8	500	34,5	1000	68,9
704	15 to 500	1,0 to 34,5	15 to 30	1,0 to 2,1	1500	103,4	2500	172,4
706	100 to 1700	6,9 to 117,2	20 to 110	1,4 to 7,6	2000	137,9	2500	172,4

**DIFFERENTIAL PRESSURE MODEL CHART**

Model	Adjustable Set Point Range		Deadband		***Working Pressure		**Proof Pressure	
	Low end of range on fall; High end of range on rise							
Type H117K	psi (unless noted)	bar (unless noted)	psi (unless noted)	bar (unless noted)	psi (unless noted)	bar	psi	bar

Kapton® diaphragm, Buna N sealing diaphragms and epoxy coated aluminum 1/8" NPT (female) pressure connections

540	0.8 to 7 "wcd	2,0 to 17,4 mbar	0.1 to 1.3 "wc	0,2 to 3,2 mbar	30 "Hg to 200	-1 to 13,8	400	27,6
541	2 to 20 "wcd	5,0 to 49,8 mbar	0.2 to 1.6 "wc	0.5 to 4,0 mbar	30 "Hg to 200	-1 to 13,8	400	27,6
542	5 to 50 "wcd	12,4 to 124,5 mbar	0.4 to 4.0 "wc	1,0 to 10,0 mbar	30 "Hg to 200	-1 to 13,8	400	27,6
543	10 to 200 "wcd	24,9 to 497,8 mbar	0.8 to 12 "wc	2,0 to 29,9 mbar	30 "Hg to 200	-1 to 13,8	400	27,6
544	2 to 20	0,1 to 1,4	0.2 to 2	13,8 mbar to 0,1	30 "Hg to 1200	-1 to 82,7	2500	172,4
545	5 to 50	0,3 to 3,4	0.4 to 3	27,6 mbar to 0,2	30 "Hg to 1200	-1 to 82,7	2500	172,4
546	10 to 125	0,7 to 8,6	0.7 to 7	48,3 mbar to 0,5	30 "Hg to 1200	-1 to 82,7	2500	172,4
547	50 to 250	3,4 to 17,2	1 to 15	0,1 to 1,0	30 "Hg to 1200	-1 to 82,7	2500	172,4
548	100 to 500	6,9 to 34,5	2 to 20	0,1 to 1,4	30 "Hg to 1200	-1 to 82,7	2500	172,4

**TEMPERATURE MODEL CHART**

Model	Adjustable Set Point Range		Max. Temp		Scale Division		†Stem/Bulb Size
	°F	°C	°F	°C	°F	°C	
Type B117	°F	°C	°F	°C	°F	°C	OD x Length
120	0 to 225	-17.8 to 107.2	275	135	10	5	9/16" x 1-7/8" below 1/2" NPT thread (nickel-plated brass)
121	200 to 425	93.3 to 218.3	475	246.1	10	5	9/16" x 1-7/8" below 1/2" NPT thread (nickel-plated brass)

**Type E117**

	Adjustable Set Point Range		Max. Temp		Scale Division		Bulb OD x length
	°F	°C	°F	°C	°F	°C	
2BSA	-120 to 100	-84.4 to 37.8	150	65.6	10	5	3/8 x 2-7/16"
5BS	-20 to 80	-28.9 to 26.7	130	54.4	5	2	3/8 x 5"
4BS	25 to 100	-3.9 to 37.8	150	65.6	2	1	3/8 x 6-3/4"
2BSB	30 to 250	-1.1 to 121.1	300	148.9	10	5	3/8 x 2-7/16"
3BS	100 to 400	37.8 to 204.4	450	232.2	10	5	3/8 x 2-1/8"
8BS	350 to 640	176.7 to 337.8	690	365.6	10	5	3/8 x 3-1/4"

Kapton® is a registered trademark of E.I. DuPont.  
†Optional immersion stem lengths and capillary lengths are available.



## HOW TO ORDER

### BUILDING A PART NUMBER

#### Select a **Type**

Refer to the "Type" section below.

Determine type number based on switch output, enclosure, adjustment and reference.

Fill in the type portion of your part number with the corresponding number.

#### Select a **Model**

Refer to the "Model Charts".

Determine model based on adjustable range, deadband and proof pressure.

Fill in the model portion of your part number with the corresponding number.

#### Select an **Option**

Refer to the "Options" section.

Determine option number based on switch output, optional materials or other product enhancements.

Fill in the option portion of your part number with the corresponding number.

Leave "option" portion blank if no options are needed. *FOR MULTIPLE OPTIONS:* Call United Electric Controls.

TYPE	DESCRIPTION
Pressure	Type H117 - One SPDT output; epoxy coated enclosure; internal adjustment with "High-Low" reference scale
Differential Pressure	Type H117K - One SPDT output; epoxy coated enclosure; internal adjustment with "High-Low" reference scale
Temperature	Type B117 - Immersion stem; One SPDT output; epoxy coated enclosure; internal adjustment with calibrated dial scale, Type E117 - Bulb and capillary; One SPDT output; epoxy coated enclosure; internal adjustment with calibrated dial scale

### SWITCH OPTIONS\*

1190	Hermetically sealed, DPDT, 11 A 125/250 VAC, products set on rising pressure or temperature only. Due to inherent separation of circuits on falling pressure or temperature, specify Option 1195 if setting on fall is required. Deadband and minimum set point will increase. NOT AVAILABLE MODELS 523, 533
1195	Hermetically sealed, DPDT, 11 A 125/250 VAC; products set on falling pressure or temperature only. Due to inherent separation of circuits on rising pressure or temperature, specify Option 1190 if setting on rise is required. Deadband and minimum set point will increase. NOT AVAILABLE MODELS 523, 533

### SENSOR AND OTHER OPTIONS

M201	Factory set one switch, specify increasing or decreasing pressure or temperature
M277	Range indicated on nameplate in kPa/MPa, factory selected. NOT AVAILABLE TEMPERATURE VERSIONS
M278	Range indicated on nameplate in Kg/cm <sup>2</sup> . NOT AVAILABLE TEMPERATURE VERSIONS
M405	Intrinsic safety compliance for European Union per ATEX standards
M406	Intrinsic safety compliance for Russia per Gosgortekhnadzor standards
M407	CE compliance to Pressure Equipment Directive (category IV). AVAILABLE ON MODELS 171-174, 183-189, 190-194, and 700-706 only
M444	Paper ID tag
M446	Stainless steel ID tag & wire attachment
M449	Mounting bracket kit. Required for models 520-535 when surface mounting. Use kit part number 6361-704 for other models
M504	316L stainless steel immersion stem. AVAILABLE TEMPERATURE MODELS 120, 121 ONLY
M540	Viton® construction (deadband and low end range may increase slightly); wetted parts include Viton® diaphragm and O-ring plus stainless steel pressure connection. AVAILABLE ON MODELS 700-704, AND 540-548 (sealing diaphragms only, main diaphragm remains Kapton®, pressure connections remain aluminum)
M550	Oxygen service cleaning; internal construction may change. NOT AVAILABLE PRESSURE MODEL 706 OR TEMPERATURE TYPE E117
SD6286-51	Watertight conduit fitting; converts 7/8" hole to 1/2" NPT (female) fitting
6361-704	Surface and Pipe Mounting Hardware (required for model 520-535, 540-548 when surface mounting)

\*Refer to Electrical Ratings under Specifications on page 3 for DC ratings.



**OPTIONAL SENSOR MATERIAL FOR "WC RANGES.** AVAILABLE MODELS 520-525

XC001	Aluminum pressure connection, Viton® diaphragm, Viton® O-ring
XC002	Aluminum pressure connection, Kapton® diaphragm, Buna N O-ring
XC003	Aluminum pressure connection, Kapton® diaphragm, Viton® O-ring
XC004	316L Stainless steel pressure connection, 316L stainless steel diaphragm, Viton® O-ring. (Over range pressure is limited to 100 psi)
XC005	316L Stainless steel pressure connection, Viton® diaphragm, Viton® O-ring
XC006	316L Stainless steel pressure connection, Kapton® diaphragm, Viton® O-ring
XC007	316L Stainless steel pressure connection, Teflon® diaphragm, Viton® O-ring

**OPTIONAL SENSOR MATERIALS FOR CORROSIVE MEDIA.** AVAILABLE MODELS 183-189, 483-489

XD002	Hastelloy® C diaphragm
XD003	Monel® diaphragm
XP112	Hastelloy® C pressure connection
XP113	Monel® pressure connection
XR211	Kalrez® O-ring
XR212	Silicone O-ring. NOT AVAILABLE MODELS 188-189, 488-489
XR213	Ethylene Propylene O-ring
XR214	Aflas® O-ring

**OPTIONAL FLUSH MOUNT FLANGES.** AVAILABLE MODELS 560-567

Other flanges (150# and 300#) available, please consult UE. Flanges conform to ANSI B16.5. Maximum pressure is limited by flange rating.

F196	Flush mounted flange, 150#, 1" lap joint, raised face. AVAILABLE MODELS 565-567 ONLY
F197	Flush mounted flange, 150#, 2" lap joint, raised face. AVAILABLE MODELS 560-564 ONLY
F198	Flush mounted flange, 300#, 1" lap joint, raised face. AVAILABLE MODELS 565-567 ONLY
F199	Flush mounted flange, 300#, 2" lap joint, raised face. AVAILABLE MODELS 560-564 ONLY

**OPTIONS FOR TEMPERATURE MODELS****UNION CONNECTORS** (Dimensional drawings may be found at [www.ueonline.com](http://www.ueonline.com))

Option	Replacement Number	Description
	<u>Brass</u>	
W027	SD6213-27	1/2" NPT w/ 3/4" bushing
W045	SD6213-45	3/4" NPT
W051	SD6213-51	1/2" NPT
	<u>304 Stainless Steel</u>	
W028	SD6213-28	1/2" NPT w/ 3/4" bushing
W046	SD6213-46	3/4" NPT
W050	SD6213-50	1/2" NPT

**THERMOWELLS** (Dimensional drawings may be found at [www.ueonline.com](http://www.ueonline.com))

*For all bulb & capillary switches*

	<u>Brass</u>	
W075	SD6225-75	1/2" NPT with 3/4" NPT adapter bushing, 4" BT
W191	SD6225-191	1/2" NPT, 4" BT
W118	SD6225-118	1/2" NPT with 3/4" NPT adapter bushing, 7" BT
W192	SD6225-192	1/2" NPT, 7" BT
	<u>316 Stainless Steel</u>	
W076	SD6225-76	3/4" NPT, 4.5" BT
W193	SD6225-193	1/2" NPT, 4.5" BT
W119	SD6225-119	3/4" NPT, 7.5" BT
W177	SD6225-177	1/2" NPT, 7.5" BT

*For all immersion stem switches*

W139	SD6225-139	3/4" NPT X 1-23/32" BT, BRASS
W140	SD6225-140	3/4" NPT X 1-23/32" BT, 316 ST/ST

## OPTIONS FOR TEMPERATURE MODELS

### W000 IMMERSION STEM AND THERMOWELLS

**Note:** Option W000 is a special Immersion Stem construction that has no external thread. This option fits inside a special thermowell and is secured with a set-screw.

Option	Description
W000	Immersion stem only, Brass
W097	Immersion stem and thermowell. Includes W000 stem and 1/2" NPT x 1-23/32" BT Brass thermowell
W099	Immersion stem and thermowell. Includes W000 stem and 1/2" NPT x 1-23/32" BT 316 st/st thermowell

### OPTIONAL LENGTHS:

Optional immersion stem lengths to 15" available in brass, with or without 316 st/st thermowell. Consult UE for additional information.

Optional capillary length to \*50' available in copper or 304 st/st. Armor or Teflon® capillary protection available to lengths less than or equal to capillary length. Consult UE for additional information.

\* Consult UE regarding repeatability and ambient effects on capillary lengths over 30'.

## DIMENSIONAL DRAWINGS

Dimensional drawings for all models may be found at [www.ueonline.com](http://www.ueonline.com)

Types H117, H117K, B117, E117

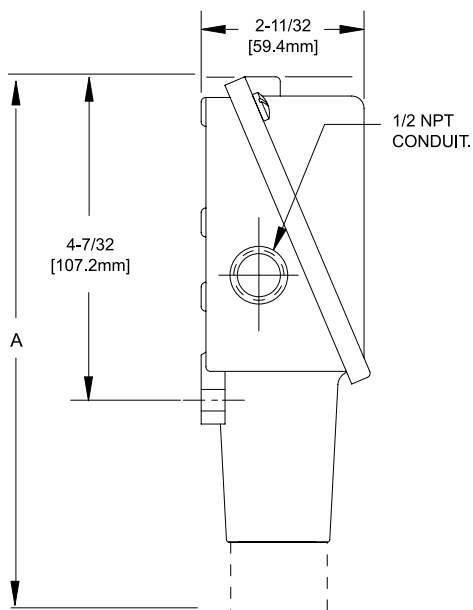

All dimensions stated in inches (millimeters)

Models	Dimension A		
	Inches	mm	NPT
<b>Pressure</b>			
171-174	7.63	193.7	1/2
183-186	7.56	192.1	1/2
188, 189	6.63	168.4	1/2
190-194	6.63	168.4	1/2
218	6.56	166.7	1/4
358-376	7.00	177.8	1/4
483-486	7.56	192.1	1/2
488, 489	6.63	168.4	1/2
490-494	6.63	168.4	1/2
520-525	8.44	214.4	1/2
530-535	8.00	203.2	1/2
560-564	6.63	168.4	2" Sanitary Fitting
565-567	6.63	168.4	1-1/2" Sanitary Fitting
700-706	6.63	168.4	1/4
<b>Differential Pressure</b>			
540-543	8.47	215.0	1/8
544-548	8.53	216.6	1/8
<b>Temperature</b>			
120,121	9.38	238.1	Immersion Stem
2BSA-8BS	8.69	220.6	Bulb & Capillary

**Types H117, H117K**

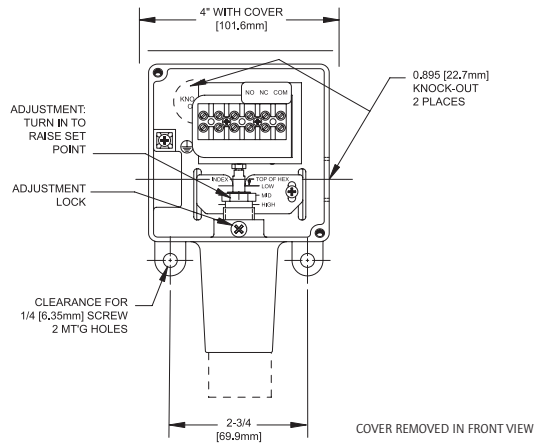

**Types B117, E117**

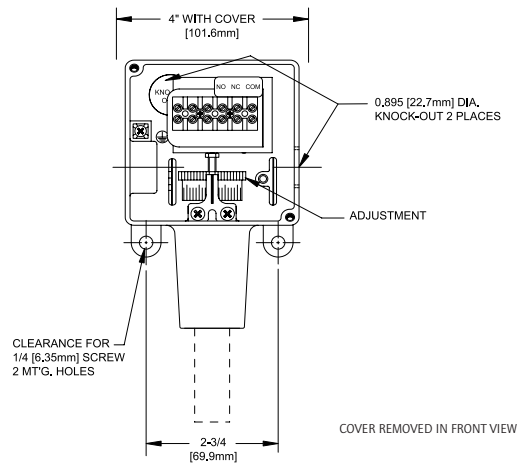

**PRESSURE SENSORS**

**Models 171-174**

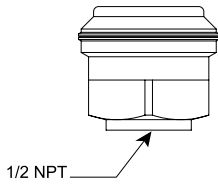

**Models 183-186, 483-486**

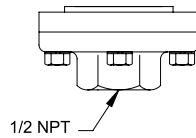

**Models 188-194, 488-494**

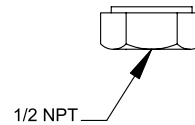

**Models 218-376, 700-706**

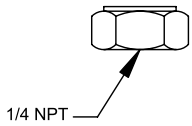

**Models 520-525**

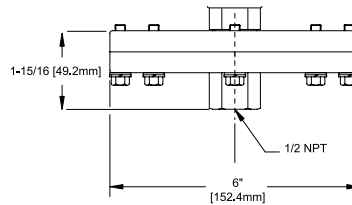

**Models 530-535**

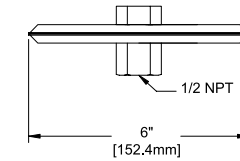

**Models 560-564**

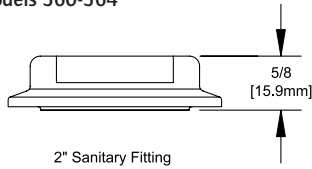

**Models 565-567**

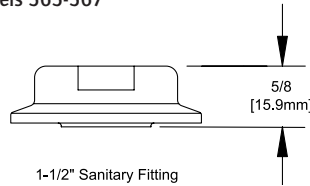

**DIFFERENTIAL PRESSURE SENSORS**

**Models 540-543**

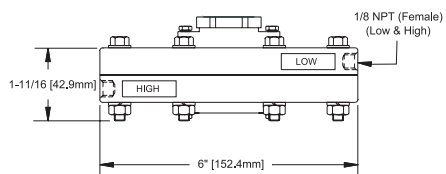

**Models 544-548**

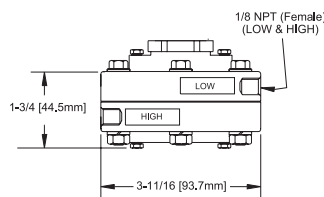

**TEMPERATURE SENSORS**

**Model 2BSA-8BS**

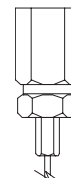

**Model 120-121**

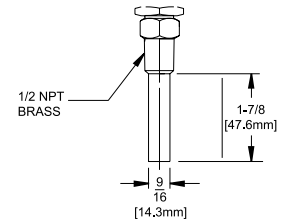

## RECOMMENDED PRACTICES AND WARNINGS

United Electric Controls Company recommends careful consideration of the following factors when specifying and installing UE pressure and temperature units. Before installing a unit, the Installation and Maintenance instructions provided with unit must be read and understood.

- To avoid damaging unit, proof pressure and maximum temperature limits stated in literature and on nameplates must never be exceeded, even by surges in the system. Operation of the unit up to maximum pressure or temperature is acceptable on a limited basis (e.g., start-up, testing) but continuous operation must be restricted to the designated adjustable range. Excessive cycling at maximum pressure or temperature limits could reduce sensor life.
- A back-up unit is necessary for applications where damage to a primary unit could endanger life, limb or property. A high or low limit switch is necessary for applications where a dangerous runaway condition could result.
- The adjustable range must be selected so that incorrect, inadvertent or malicious setting at any range point cannot result in an unsafe system condition.
- Install unit where shock, vibration and ambient temperature fluctuations will not damage unit or affect operation. Orient unit so that moisture does not enter the enclosure via the electrical connection. When appropriate, this entry point should be sealed to prevent moisture entry.
- Unit must not be altered or modified after shipment. Consult UE if modification is necessary.
- Monitor operation to observe warning signs of possible damage to unit, such as drift in set point or faulty display. Check unit immediately.
- Preventative maintenance and periodic testing is necessary for critical applications where damage could endanger property or personnel.
- For all applications, a factory set unit should be tested before use.
- Electrical ratings stated in literature and on nameplate must not be exceeded. Overload on a switch can cause damage, even on the first cycle. Wire unit according to local and national electrical codes, using wire size recommended in installation sheet.
- Do not mount unit in ambient temp. exceeding published limits.

## LIMITED WARRANTY

Seller warrants that the product hereby purchased is, upon delivery, free from defects in material and workmanship and that any such product which is found to be defective in such workmanship or material will be repaired or replaced by Seller (Ex-works, Factory, Watertown, Massachusetts. INCOTERMS); provided, however, that this warranty applies only to equipment found to be so defective within a period of 24 months from the date of manufacture by the Seller. Seller shall not be obligated under this warranty for alleged defects which examination discloses are due to tampering, misuse, neglect, improper storage, and in any case where products are disassembled by anyone other than authorized Seller's representatives. EXCEPT FOR THE LIMITED WARRANTY OF REPAIR AND REPLACEMENT STATED ABOVE, SELLER DISCLAIMS ALL WARRANTIES WHATSOEVER WITH RESPECT TO THE PRODUCT, INCLUDING ALL IMPLIED WARRANTIES OF MERCHANTABILITY OR FITNESS FOR ANY PARTICULAR PURPOSE.

## LIMITATION OF SELLER'S LIABILITY

Seller's liability to Buyer for any loss or claim, including liability incurred in connection with (i) breach of any warranty whatsoever, expressed or implied, (ii) a breach of contract, (iii) a negligent act or acts (or negligent failure to act) committed by Seller, or (iv) an act for which strict liability will be inputted to seller, is limited to the "limited warranty" of repair and/or replacement as so stated in our warranty of product. In no event shall the Seller be liable for any special, indirect, consequential or other damages of a like general nature, including, without limitation, loss of profits or production, or loss or expenses of any nature incurred by the buyer or any third party.

*UE specifications subject to change without notice.*

## U.S. SALES OFFICES

United Electric Controls  
31 Old Stage Road  
Hampton Falls, NH 03844  
Phone: 617-899-1132  
email: [northeastsales@ueonline.com](mailto:northeastsales@ueonline.com)

United Electric Controls  
28 N. Wise Ave.  
Freeport, IL 61032  
Phone: 815-341-2588  
email: [midwestsales@ueonline.com](mailto:midwestsales@ueonline.com)

United Electric Controls  
1022 Vineyard Drive  
Conyers, GA 30013  
Phone: 770-335-9802  
email: [southeastsales@ueonline.com](mailto:southeastsales@ueonline.com)

United Electric Controls  
5829 Grazing Court  
Mason, OH 45040  
Phone: 513-535-5486  
email: [midatlanticsales@ueonline.com](mailto:midatlanticsales@ueonline.com)

United Electric Controls  
102 Salazar Court  
Clayton, CA 94517  
Phone: 925-408-5997  
email: [westcoastsales@ueonline.com](mailto:westcoastsales@ueonline.com)

United Electric Controls  
27 Summit Terrace  
Sparta, NJ 07871  
Phone: 973-271-2550  
email: [easternsales@ueonline.com](mailto:easternsales@ueonline.com)

United Electric Controls  
4306 Whickham Drive  
Fulshear, TX 77441  
Phone: 832-457-6138  
email: [southwestsales@ueonline.com](mailto:southwestsales@ueonline.com)

United Electric Controls  
5201 Arbor Court  
Odessa, TX 79762  
Phone: 432-770-4164  
email: [westtexasales@ueonline.com](mailto:westtexasales@ueonline.com)

## CANADA

EASTERN  
68 Mosley Crescent  
Brampton, Ontario  
Canada L6Y 5C8  
Phone: 905-455-5131  
FAX: 905-455-5131

WESTERN  
148 Silver Ridge Close N.W.  
Calgary, Alberta  
Canada T3B 3T4  
Phone: 403-247-3724  
FAX: 403-247-3724



UNITED ELECTRIC  
CONTROLS

180 Dexter Avenue, P.O. Box 9143  
Watertown, MA 02471-9143 USA  
Telephone: 617 926-1000 Fax: 617 926-2568  
<http://www.ueonline.com>

## INTERNATIONAL OFFICES

CHINA  
United Electric Controls  
Room 1011, 10th Flr,  
Huai Hai Zhonghua Building  
No. 885, Renmin Road, Luwan District  
Shanghai 200010, P.R. China  
Phone: +8621-6255 8059  
email: [chinasales@ueonline.com](mailto:chinasales@ueonline.com)

EASTERN EUROPE & SCANDINAVIA  
United Electric Controls  
05-806 Komorow  
Kujawska 5, Poland  
Phone: +48 22 499 4804  
email: [easterneuropesales@ueonline.com](mailto:easterneuropesales@ueonline.com)

GERMANY  
United Electric Controls  
An Der Zentlinde 21  
D-64711 Erbach, Germany  
Phone: 496-062-7400  
email: [europesales@ueonline.com](mailto:europesales@ueonline.com)

INDIA  
United Electric Controls  
House no. 7, Kamalkunj Society  
Nizampura,  
Baraoda (Gujarat), India  
email: [indiasales@ueonline.com](mailto:indiasales@ueonline.com)

MALAYSIA  
United Electric Controls, Far East  
No. 1-2-2, 2nd Floor  
Jalan 4/101C  
Cheras Business Centre  
Batu 5, Jalan Cheras  
56100 Kuala Lumpur, Malaysia  
Phone: 603-9133-4122  
email: [fareastsales@ueonline.com](mailto:fareastsales@ueonline.com)

MEXICO  
United Electric Controls  
Andador Austria 102  
Fracc. Petroquimica CP 89365  
Tampico, Tamaulipas Mexico  
Phone: 833-132-3726  
email: [latinamericasales@ueonline.com](mailto:latinamericasales@ueonline.com)

RUSSIA  
United Electric Controls, Moscow  
Kuusinena str., 19A, Office 310  
Moscow, 125252, Russia  
Phone: +7 (095) 792-88-06  
email: [russiansales@ueonline.com](mailto:russiansales@ueonline.com)