

Q

uick Start

P

rogramming











G

uide



UE UNITED ELECTRIC CONTROLS

QUICK START INSTRUCTIONS

- I. Press the left and right buttons (both)   simultaneously.
- II. Press the left button .
- III. Press the right button  to select the switch mode, set point and/or deadband.
- IV. Press the left button  to make the desired changes to each.
- V. Press both buttons  , then the right , then the left , then both   to save changes.

UE UNITED ELECTRIC CONTROLS

180 Dexter Ave., P.O. Box 9143
Watertown, MA 02471-9143

Phone: 617.926.1000

Fax: 617.926.2568

PROGRAMMING FLOWCHART

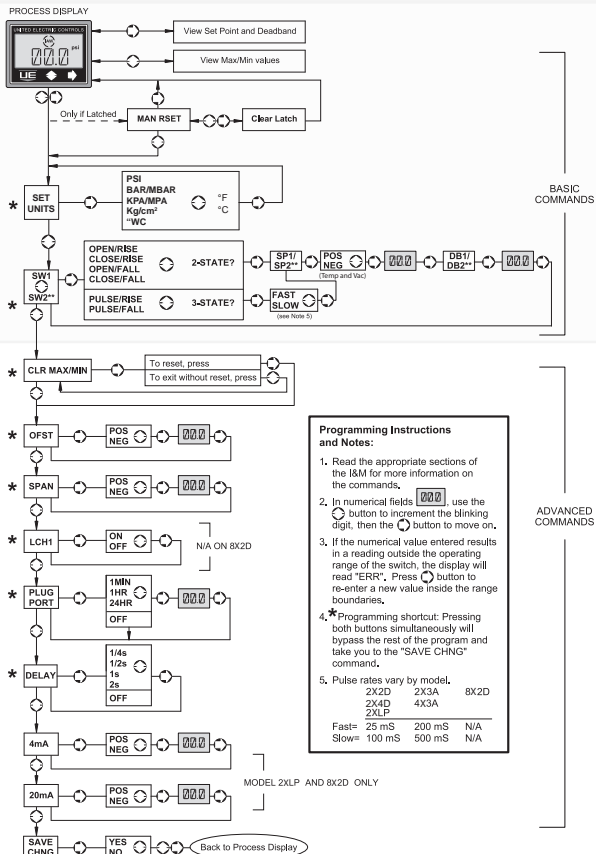

* PRESS BOTH BUTTONS TO SKIP TO "SAVE CHNG" COMMAND

**8X2D ONLY