

Level Measurement

Continuous level measurement - Radar transmitters

SITRANS LR200

Overview

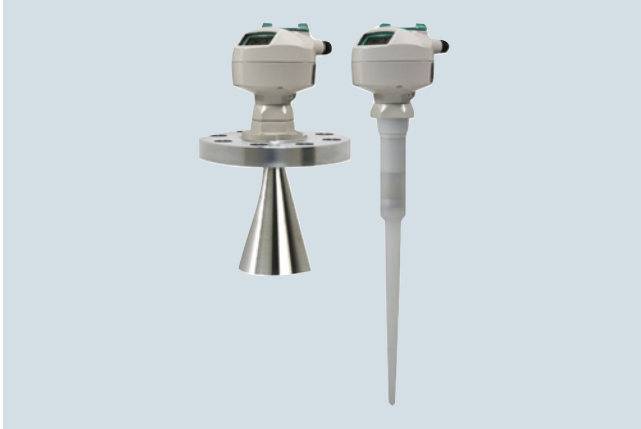

SITRANS LR200 is a 2-wire, 6 GHz pulse radar level transmitter for continuous monitoring of liquids and slurries in process vessels including high temperature, pressure, agitation, and turbulence to a range of 20 m (65 ft).

Benefits

- Graphical local user interface (LUI) makes operation simple with plug-and-play setup using the intuitive Quick Start Wizard
- LUI displays echo profiles for diagnostic support
- Communication using HART or PROFIBUS PA
- Process Intelligence signal processing for improved measurement reliability and Auto False-Echo Suppression of fixed obstructions
- Programming using infrared Intrinsically Safe handheld programmer or SIMATIC PDM

Application

SITRANS LR200's unique design allows safe and simple programming using the Intrinsically Safe handheld programmer without having to open the instrument's lid. It also features a built-in alphanumeric display in four languages.

The SITRANS LR200 has a standard Uni-Construction polypropylene rod antenna that offers excellent chemical resistance and is hermetically sealed. The Uni-Construction antenna features an internal, integrated shield that eliminates vessel nozzle interference.

Start-up is easy with as few as two parameters for basic operation. Installation is simplified as the electronics are mounted on a rotating head that swivels, allowing the instrument to line up with conduit or wiring connections or simply to adjust the position for easy viewing. SITRANS LR200 features Process Intelligence signal-processing technology for superior reliability.

- Key Applications: liquid process vessels with agitators, vaporous liquids, high temperatures, asphalt, digesters

Configuration

Installation

Min. 300 mm (1 ft) for every 3 m (10 ft) of vessel wall.

Note:

- Beam angle is the width of the cone where the energy density is half of the peak energy density.
- Beam angle for horn antenna dependent on horn size
- The peak energy density is directly in front of and in line with the rod antenna.
- There is a signal transmitted outside of the beam angle; therefore false targets may be detected.

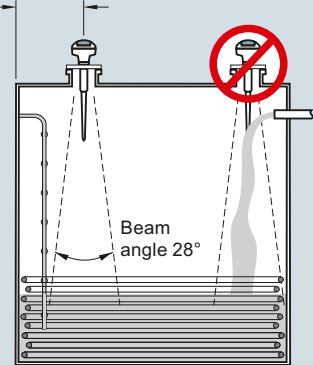

Mounting unit on vessel

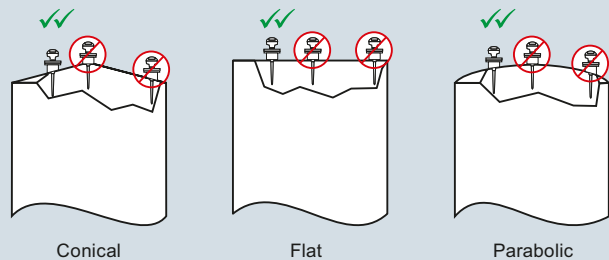

Mounting unit on stilling well

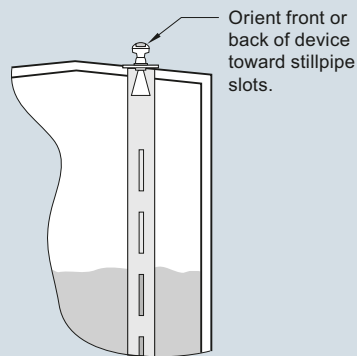

Mounting on a nozzle

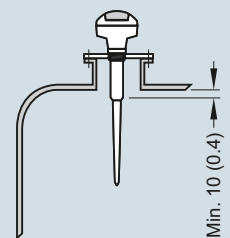

SITRANS LR200 installation, dimensions in mm (inch)

Technical specifications

Mode of operation		Power supply		
Measuring principle	Radar level measurement	4 ... 20 mA/HART	Nominal 24 V DC (max. 30 V DC) with max. 550 Ω Nominal 24 V DC (max. 30 V DC) with max. 250 Ω	
Frequency	5.8 GHz (North America 6.3 GHz)	<ul style="list-style-type: none"> General Purpose, Non-incendive, Intrinsically Safe Flame proof, Increased safety, Explosion proof 		
Measuring range	0.3 ... 20 m (1.0 ... 65 ft)	PROFIBUS PA	<ul style="list-style-type: none"> 10.5 mA Per IEC 61158-2 	
Output		Certificates and approvals		
Analog output	4 ... 20 mA	General	CSA _{US/IC} , CE, FM, RCM	
Accuracy	± 0.02 mA	Marine	<ul style="list-style-type: none"> Lloyd's Register of Shipping ABS Type Approval 	
Span	Proportional or inversely proportional	Radio	FCC, Industry Canada and European (R&TTE), RCM	
Communications	HART Optional: PROFIBUS PA (Profile 3.0, Class B)	Hazardous	INMETRO Ex ia IIC T4 Ga CSA/FM, Class I, Div. 1, Groups A, B, C, D; Class II, Div. 1, Groups E, F, G; Class III, T4 CSA/FM, Class I, Div. 1, Groups A, B, C, D; Class II, Div. 1, Groups E, F, G; Class III, T4 FM, Class I, Div. 2, Groups A, B, C, D, T5 NEPSI Ex d mb ia IIC T4/ Ex e mb ia IIC T4 ATEX II 1/2 G Ex d mb ia IIC T4 Ga/Gb ATEX II 1/2 G Ex e mb ia IIC T4 Ga/Gb ATEX II 1G Ex ia IIC T4 IECEX Ex ia IIC T4 GOST-R Ex ia	
Fail-safe	Programmable as high, low or hold (Loss of Echo)	<ul style="list-style-type: none"> Intrinsically Safe (Brazil) Explosion Proof (Canada/USA) 		
Performance (according to reference conditions IEC60770-1)		<ul style="list-style-type: none"> Intrinsically Safe (Canada/USA) 		
From end of antenna to 600 mm:	40 mm (1.57 inch)	<ul style="list-style-type: none"> Non-incendive (USA) 		
Remainder of range:	10 mm (0.4 inch) or 0.1 % of span (whichever is greater)	<ul style="list-style-type: none"> Flame Proof/Increased Safety (China) Flame Proof (Europe) 		
Rated operating conditions		<ul style="list-style-type: none"> Increased Safety (Europe) 		
Installation conditions	Indoor/outdoor	<ul style="list-style-type: none"> Intrinsically Safe (Europe) Intrinsically Safe (International) Intrinsically Safe (Russia) 		
<ul style="list-style-type: none"> Location 				
Ambient conditions (enclosure)	-40 ... +80 °C (-40 ... +176 °F) I 4	Programming		
<ul style="list-style-type: none"> Ambient temperature Installation category Pollution degree 		Intrinsically Safe Siemens handheld programmer	Infrared receiver	
Medium conditions		<ul style="list-style-type: none"> Approvals for handheld programmer 	IS model: ATEX II 1GD Ex ia IIC T4 Ga Ex iaD 20 T135 °C T _a = -20 ... +50 °C CSA/FM Class I, II, and III, Div. 1, Groups A, B, C, D, E, F, G, T6 T _a = +50 °C	
Dielectric constant ϵ_r		$\epsilon_r > 1.6$ (for $\epsilon_r < 3$, use stillpipe)	Handheld communicator	HART communicator 375
Vessel temperature and pressure	Varies with connection type; see Pressure/Temperature curves for more information	PC	<ul style="list-style-type: none"> SIMATIC PDM AMS 	
Design		Display (local)	Multi-segment alphanumeric liquid crystal with bar graph (representing level) available in four languages	
Enclosure	Aluminum, polyester powder coated 2 x M20x1.5 or 2 x 1/2" NPT with adapter			
<ul style="list-style-type: none"> Material Cable inlet 				
Degree of protection	Type 4X/NEMA 4X, Type 6/ NEMA 6, IP67, IP68			
Weight	< 2.82 kg (6.21 lb) (polypropylene rod antenna)			
Display (local)	Multi-segment alphanumeric liquid crystal with bar graph (representing level) available in four languages			
Antenna	Polypropylene rod, hermetically sealed construction, optional PTFE Standard 100 mm (4 inch) shield for maximum 100 mm (4 inch) nozzle, or optional 250 mm (10 inch) long shield Refer to SITRANS LR200 Antennas for optional rods and horns			
<ul style="list-style-type: none"> Material 				
<ul style="list-style-type: none"> Dimensions 				
<ul style="list-style-type: none"> Optional rods and horn 				
Process connections	1 1/2" NPT [(Taper), ANSI/ASME B1.20.1] R 1 1/2" [(BSPT), EN 10226], or G 1 1/2" [(BSPP), EN ISO 228-1] (polypropylene rod antenna) Refer to SITRANS LR200 Antennas for more connections			
<ul style="list-style-type: none"> Process connection 				
<ul style="list-style-type: none"> Flange connection 				

Level Measurement

Continuous level measurement - Radar transmitters

SITRANS LR200

Selection and Ordering data

SITRANS LR200, Uni-Construction polypropylene rod antenna version

2-wire, 6 GHz pulse radar level transmitter for continuous monitoring of liquids and slurries in process vessels including high temperature and pressure, to a range of 20 m (66 ft).

Max. 3 bar g (43.5 psi g) pressure and 80 °C (176 °F)

➤ Click on the Article No. for the online configuration in the PIA Life Cycle Portal.

Enclosure/Cable inlet

Aluminum, epoxy painted
2 x 1/2" NPT
2 x M20x1.5

Polypropylene antenna type - (Max. 3 Bar pressure and 80 °C)

1 1/2" NPT [(Taper), ANSI/ASME B1.20.1], c/w integral 100 mm shield
R 1 1/2" [(BSPT), EN 10226], c/w integral 100 mm shield
G 1 1/2" [(BSPP), EN ISO 228-1], c/w integral 100 mm shield

1 1/2" NPT [(Taper), ANSI/ASME B1.20.1], c/w integral 250 mm shield
R 1 1/2" [(BSPT), EN 10226], c/w integral 250 mm shield
G 1 1/2" [(BSPP), EN ISO 228-1], c/w integral 250 mm shield

Approvals

General Purpose, CE, R&TTE, RCM
General Purpose, CSA, FM, Industry Canada, FCC
Intrinsically Safe, CSA Class I, II, Div. 1, Groups A, B, C, D, E, F, G, Industry Canada

Intrinsically Safe, FM Class I, II, Div. 1, Groups A, B, C, D, E, F, G, FCC
Intrinsically Safe, IECEx/ATEX II 1G Ex ia IIC T4, INMETRO Ex ia IIC T4, CE, R&TTE, RCM; GOST-R Non incandive, FM Class I, Div. 2, Groups A, B, C, D, FCC¹⁾

Increased Safety, ATEX II 1/2G Ex e mb ia IIC T4 Ga/Gb, CE, R&TTE, RCM; GOST-R²⁾³⁾
Flame Proof, ATEX II 1/2G Ex d mb ia IIC T4 Ga/Gb, CE, R&TTE, RCM; GOST-R³⁾
Explosion Proof, CSA/FM Class I, II, III, Groups A, B, C, D, E, F, G, Industry Canada, FCC¹⁾³⁾

Communication/Output

PROFIBUS PA
4 ... 20 mA, HART, start-up at < 3.6 mA

¹⁾ Available with enclosure option 2 only

²⁾ Available with enclosure option 3 only

³⁾ Available with communication option 3 only

Article No.

7ML5422-

0

2

3

A

B

C

D

E

F

A

B

C

D

E

F

G

H

J

2

3

Selection and Ordering data

Further designs

Please add "-Z" to Article No. and specify Order code(s).

Stainless steel tag [69 x 50 mm (2.71 x 1.97 inch)]:
Measuring-point number/identification (max. 27 characters); specify in plain text

Manufacturer's test certificate: M to DIN 55350, Part 18 and to ISO 9000

Namur NE43 compliant, device preset to failsafe < 3.6 mA¹⁾

Operating Instructions for HART/mA device

English

German

Note: The Operating Instructions should be ordered as a separate line item on the order.

Multi-language Quick Start manual
This device is shipped with the Siemens Milltronics manual DVD containing the ATEX Quick Start and Operating Instructions library.

Operating Instructions for PROFIBUS PA device

English

German

Note: The Operating Instructions should be ordered as a separate line item on the order.

Multi-language Quick Start manual
This device is shipped with the Siemens Milltronics manual DVD containing the ATEX Quick Start and Operating Instructions library.

Accessories

Handheld programmer, Intrinsically safe, EEx ia
HART modem/USB
(for use with a PC and SIMATIC PDM)

One metallic cable gland M20x1.5, rated -40 ... +80 °C (-40 ... +176 °F), HART²⁾

One metallic cable gland M20x1.5, rated -40 ... +80 °C (-40 ... +176 °F), PROFIBUS PA²⁾

One general purpose polymeric cable gland M20x1.5, rated -20 ... +80 °C (-40 ... +176 °F)

SITRANS RD100, loop powered display - see Chapter 7

SITRANS RD200, universal input display with Modbus conversion - see Chapter 7

SITRANS RD300, dual line display with totalizer and linearization curve and Modbus conversion - see Chapter 7

SITRANS RD500 web, universal remote monitoring solution for instrumentation - see Chapter 7

For applicable back up point level switch - see point level measurement section

¹⁾ Available with communication option 3 only

²⁾ Product shipped with plastic cable gland, rated to -20 °C.
If -40 °C rating required, then metallic cable gland is recommended.

Order code

Y15

C11

N07

Article No.

A5E32337676

A5E34942758

A5E31993614

A5E32337680

A5E34942820

A5E32153438

7ML1930-1BK

7MF4997-1DB

7ML1930-1AP

7ML1930-1AQ

7ML1930-1AM

7ML5741-...

7ML5740-...

7ML5744-...

7ML5750-...

Level Measurement

Continuous level measurement - Radar transmitters

SITRANS LR200

Selection and Ordering data	Article No.	Selection and Ordering data	Article No.
SITRANS LR200, Flange Adapter/PTFE Rod Antenna Version 2-wire, 6 GHz pulse radar level transmitter for continuous monitoring of liquids and slurries in process vessels including high temperature and pressure, to a range of 20 m (66 ft). ↗ Click on the Article No. for the online configuration in the PIA Life Cycle Portal.	7ML5423-	SITRANS LR200, Flange Adapter/PTFE Rod Antenna Version 2-wire, 6 GHz pulse radar level transmitter for continuous monitoring of liquids and slurries in process vessels including high temperature and pressure, to a range of 20 m (66 ft).	7ML5423-
Antenna material (uses antenna adapter) PTFE, uses antenna adapter and additional process connection below	1	Enclosure/Cable inlet Aluminum, Epoxy painted 2 x 1/2" NPT 2 x M20x1.5	2 3
Process connection (refer to Pressure/Temperature curves, page 4/208) Flanges (316L stainless steel) DN 50 PN 16, Type A, flat faced DN 80 PN 16, Type A, flat faced DN 100 PN 16, Type A, flat faced DN 150 PN 16, Type A, flat faced 2" ASME 150 lb, flat faced 3" ASME 150 lb, flat faced 4" ASME 150 lb, flat faced 6" ASME 150 lb, flat faced DN 50 PN 40, flat faced DN 80 PN 40, flat faced DN 100 PN 40, flat faced DN 150 PN 40, flat faced 2" ASME 300 lb, flat faced, available with Pressure rating option 1 only due to flange hole spacing 3" ASME 300 lb, flat faced 4" ASME 300 lb, flat faced 6" ASME 300 lb, flat faced JIS DN 50 10K JIS DN 80 10K JIS DN 100 10K JIS DN 150 10K (Note: Flange bolting patterns and facings dimensionally correspond to the applicable ASME B16.5, or EN 1092-1, or JIS B 2220 standard.) Threaded connection (316L stainless steel) 1 1/2" NPT [(Taper), ANSI/ASME B1.20.1] 2" NPT [(Taper), ANSI/ASME B1.20.1] R 1 1/2" [(BSPT), EN 10226] R 2" [(BSPT), EN 10226] G 1 1/2" [(BSPP), EN ISO 228-1] G 2" [(BSPP), EN ISO 228-1]	AA BA CA DA FB GB HB JB AC BC CC DC FD GD HD JD AE BE CE DE	Communication/Output PROFIBUS PA 4 ... 20 mA, HART, start-up at < 3.6 mA	B C
Antenna extensions or Inactive shield length No antenna extension 50 mm (2 inch) extension, PTFE 100 mm (4 inch) extension, PTFE 100 mm (4 inch) extension, 316L stainless steel shield ¹⁾ 150 mm (6 inch) extension, 316L stainless steel shield ¹⁾ 200 mm (8 inch) extension, 316L stainless steel shield ¹⁾ 250 mm (10 inch) extension, 316L stainless steel shield ¹⁾	0 1 2 3 4 5 6	Approvals General Purpose, CE, R&TTE, RCM General Purpose, CSA FM, Industry Canada, FCC Intrinsically Safe, CSA Class I, II, Div. 1, Groups A, B, C, D, E, F, G, Industry Canada Intrinsically Safe, FM Class I, II, Div. 1, Groups A, B, C, D, E, F, G, FCC Intrinsically Safe, IECEx/ATEX II 1G Ex ia IIC T4, INMETRO Ex ia IIC T4, CE, R&TTE, RCM; GOST-R Non incensive, FM Class I, Div. 2, Groups A, B, C, D, FCC ²⁾ Increased Safety, ATEX II 1/2G Ex e mb ia IIC T4 Ga/Gb, CE, R&TTE, RCM; GOST-R ³⁾⁴⁾ Flame Proof, ATEX II 1/2G Ex d mb ia IIC T4 Ga/Gb, CE, R&TTE, RCM; GOST-R ⁴⁾ Explosion Proof, CSA/FM Class I, II, III, Groups A, B, C, D, E, F, G, Industry Canada, FCC ²⁾⁴⁾	A B C D E F G H J
Process seal/gasket Integral Gasket, for flat faced flange process connections only, not for Antenna extension options 3 ... 6 FKM O-ring, not available for combination of flat faced flanges with Antenna extension options 0, 1 or 2	0 1	Pressure rating Rating per Pressure/Temperature curves in manual 0.5 bar g (7.25 psi g) maximum	0 1

- 1) Available with process connection options BA, CA, DA, GB, HB, JB, BC, CC, DC, GD, HD, JD, BE, CE, DE, MA, MC, ME only
- 2) Available with enclosure option 2 only
- 3) Available with enclosure option 3 only
- 4) Available with communication option C only

Level Measurement

Continuous level measurement - Radar transmitters

SITRANS LR200

Selection and Ordering data	Order code
Further designs	
Please add "-Z" to Article No. and specify Order code(s).	
Stainless steel tag [69 x 50 mm (2.71 x 1.97 inch)]; Measuring-point number/identification (max. 27 characters); specify in plain text	Y15
Manufacturer's test certificate: M to DIN 55350, Part 18 and to ISO 9000	C11
Inspection Certificate Type 3.1 per EN 10204	C12
Namur NE43 compliant, device preset to failsafe < 3.6 mA ³⁾	N07
Operating Instructions for HART/mA device	
English	A5E32337676
German	A5E34942758
Note: The Operating Instructions should be ordered as a separate line item on the order.	
Multi-language Quick Start manual This device is shipped with the Siemens Milltronics manual DVD containing the ATEX Quick Start and Operating Instructions library.	A5E31993614
Operating Instructions for PROFIBUS PA device	
English	A5E32337680
German	A5E34942820
Note: The Operating Instructions should be ordered as a separate line item on the order.	
Multi-language Quick Start manual This device is shipped with the Siemens Milltronics manual DVD containing the ATEX Quick Start and Operating Instructions library.	A5E32153438
Accessories	
Handheld programmer, Intrinsically safe, EEx ia	7ML1930-1BK
Antenna, rod, PTFE	7ML1830-1HC
Antenna extension, 50 mm (2 inch), PTFE	7ML1830-1CH
Antenna extension, 100 mm (4 inch), PTFE	7ML1830-1CG
HART modem / USB (for use with PC and SIMATIC PDM)	7MF4997-1DB
Metallic cable gland M20 x 1.5, rated -40 °C (-40 °F) ... 80 °C (176 °F), HART (two are required)	7ML1930-1AP
Metallic cable gland M20 x 1.5, rated -40 °C (-40 °F) ... 80 °C (176 °F), PROFIBUS PA (two are required)	7ML1930-1AQ
One General Purpose polymeric cable gland M20 x 1.5, rating for -20 °C (-4°F) ...+ 80 °C (176 °F)	7ML1930-1AM
SITRANS RD100, loop powered display - see Chapter 7	7ML5741-...
SITRANS RD200, universal input display with Modbus conversion - see Chapter 7	7ML5740-...
SITRANS RD300, dual line display with totalizer and linearization curve and Modbus conversion - see Chapter 7	7ML5744-...
SITRANS RD500 web, universal remote monitoring solution for instrumentation - see Chapter 7	7ML5750-...
For applicable back up point level switch - see point level measurement section	

Selection and Ordering data	Article No.	Selection and Ordering data	Article No.
SITRANS LR200, Flange adapter/Horn Antenna version 2-wire, 6 GHz pulse radar level transmitter for continuous monitoring of liquids and slurries in process vessels including high temperature and pressure, to a range of 20 m (66 ft). ↗ Click on the Article No. for the online configuration in the PIA Life Cycle Portal.	7ML5425-	SITRANS LR200, Flange adapter/Horn Antenna version 2-wire, 6 GHz pulse radar level transmitter for continuous monitoring of liquids and slurries in process vessels including high temperature and pressure, to a range of 20 m (66 ft).	7ML5425-
Antenna material (uses antenna adapter) 316L stainless steel with PTFE cone emitter 316L stainless steel with PTFE cone emitter and purge connection with 1/8" NPT inlet ¹⁾ Sliding waveguide system with 1 000 mm (40 inch) waveguide ¹⁾²⁾	0 1 2	Process seal/gasket FKM (-40 ... +200 °C) Nitrile (-40 ... +60 °C), sliding waveguide systems only FFKM (-35 ... +200 °C)	0 1 2
Process connection (refer to Pressure/Temperature curves, page 4/209) Flanges (316L stainless steel) DN 50 PN 16 EN 1092-1 Type A flat faced ¹⁾ DN 80 PN 16 EN 1092-1 Type A flat faced DN 100 PN 16 EN 1092-1 Type A flat faced DN 150 PN 16 EN 1092-1 Type A flat faced DN 200 PN 16 EN 1092-1 Type A flat faced DN 80 PN 10/16 DIN EN 1092-1 Type B1 raised face ³⁾ DN 100 PN 10/16 DIN EN 1092-1 Type B1 raised face ³⁾ DN 150 PN 10/16 DIN EN 1092-1 Type B1 raised face ³⁾ DN 200 PN 16 DIN EN 1092-1 Type B1 raised face ³⁾ 2" ASME 150 lb, flat faced ¹⁾ 3" ASME 150 lb, flat faced 4" ASME 150 lb, flat faced 6" ASME 150 lb, flat faced 8" ASME 150 lb, flat faced DN 50 PN 40, flat faced ³⁾ DN 80 PN 40, flat faced ³⁾ DN 100 PN 40, flat faced ³⁾ DN 200 PN 40, flat faced ³⁾ DN 80 PN 25/40 DIN EN 1092-1 Type B1 raised face ³⁾ DN 100 PN 25/40 DIN EN 1092-1 Type B1 raised face ³⁾ DN 150 PN 25/40 DIN EN 1092-1 Type B1 raised face ³⁾ 2" ASME 300 lb, flat faced ¹⁾³⁾ 3" ASME 300 lb, flat faced ³⁾ 4" ASME 300 lb, flat faced ³⁾ JIS DN 50 10K ¹⁾ JIS DN 80 10K JIS DN 100 10K JIS DN 150 10K JIS DN 200 10K (Note: Flange bolting patterns and facings dimensionally correspond to the applicable ASME B16.5, or EN 1092-1, or JIS B 2220 standard.)	AA BA CA DA EA BF CF DF EF FB GB HB JB KB AC BC CC EC CG DG EG FD GD HD AE BE CE DE EE	Enclosure/Cable inlet Aluminum, Epoxy painted 2 x 1/2" NPT 2 x M20x1.5	2 3
Communication/Output PROFIBUS PA 4 ... 20 mA, HART, start-up at < 3.6 mA	1 2	Horn size/Waveguide options 80 mm (3 inch) horn ⁴⁾ 100 mm (4 inch) horn ⁴⁾ 150 mm (6 inch) horn 200 mm (8 inch) horn 100 mm (4 inch) horn with 100 mm (4 inch) waveguide extension ⁴⁾ 100 mm (4 inch) horn with 150 mm (6 inch) waveguide extension ⁴⁾ 100 mm (4 inch) horn with 200 mm (8 inch) waveguide extension ⁴⁾ 100 mm (4 inch) horn with 250 mm (10 inch) waveguide extension ⁴⁾ 150 mm (6 inch) horn with 100 mm (4 inch) waveguide extension 150 mm (6 inch) horn with 150 mm (6 inch) waveguide extension 150 mm (6 inch) horn with 200 mm (8 inch) waveguide extension 150 mm (6 inch) horn with 250 mm (10 inch) waveguide extension 200 mm (8 inch) horn with 100 mm (4 inch) waveguide extension 200 mm (8 inch) horn with 150 mm (6 inch) waveguide extension 200 mm (8 inch) horn with 200 mm (8 inch) waveguide extension 200 mm (8 inch) horn with 250 mm (10 inch) waveguide extension (Add Order code Y01 and plain text: "waveguide length ... mm")	B C D E F G H J K L M N P Q R S

Level Measurement

Continuous level measurement - Radar transmitters

SITRANS LR200

Selection and Ordering data

SITRANS LR200, Flange adapter/Horn Antenna version

2-wire, 6 GHz pulse radar level transmitter for continuous monitoring of liquids and slurries in process vessels including high temperature and pressure, to a range of 20 m (66 ft).

Approvals

General Purpose, CE, R&TTE, RCM
General Purpose, CSA, FM, Industry Canada, FCC
Intrinsically Safe, CSA Class I, II, Div. 1, Groups A, B, C, D, E, F, G, Industry Canada

Intrinsically Safe, FM Class I, II, Div. 1, Groups A, B, C, D, E, F, G, FCC

Intrinsically Safe, IECEx/ATEX II 1G Ex ia IIC T4, INMETRO Ex ia IIC T4, CE, R&TTE, RCM; GOST-R Non Incendive, FM Class I, Div. 2, Groups A, B, C, D, FCC⁵⁾

Increased Safety, ATEX II 1/2G Ex e mb ia IIC T4 Ga/Gb, CE, R&TTE, RCM; GOST-R⁶⁾⁷⁾

Flame Proof, ATEX II 1/2G Ex d mb ia IIC T4 Ga/Gb, CE, R&TTE, RCM; GOST-R⁷⁾

Explosion Proof, CSA/FM Class I, II, III, Groups A, B, C, D, E, F, G, Industry Canada, FCC⁵⁾⁷⁾

Pressure rating

Rating per Pressure/Temperature curves in manual 0.5 bar g (7.25 psi g) maximum

- 1) Available with pressure rating option 1 only
- 2) Maximum Process Temperature 60 °C (140 °F)
- 3) Available with Antenna Material option 0 and 1 only
- 4) For stillpipe applications only
- 5) Available with enclosure option 2 only
- 6) Available with enclosure option 3 only
- 7) Available with communication option 2 only

Article No.

7ML5425-



A

B

C

D

E

F

G

H

J

0

1

Selection and Ordering data

Further designs

Please add "-Z" to Article No. and specify Order code(s).

Stainless steel tag [69 x 50 mm (2.71 x 1.97 inch)]:
Measuring-point number/identification
(max. 27 characters); specify in plain text

Y15

Manufacturer's test certificate: M to DIN 55350,
Part 18 and to ISO 9000

C11

Inspection Certificate Type 3.1 per EN 10204

C12

Namur NE43 compliant, device preset to failsafe
< 3.6 mA¹⁾

N07

Operating Instructions for HART/mA device

English

Article No.

A5E32337676

German

A5E34942758

Note: The Operating Instructions should be
ordered as a separate line item on the order.

Multi-language Quick Start manual
This device is shipped with the Siemens Milltronics
manual DVD containing the ATEX Quick Start and
Operating Instructions library.

A5E31993614

Operating Instructions for PROFIBUS PA device

English

A5E32337680

German

A5E34942820

Note: The Operating Instructions should be
ordered as a separate line item on the order.

Multi-language Quick Start manual
This device is shipped with the Siemens Milltronics
manual DVD containing the ATEX Quick Start and
Operating Instructions library.

A5E32153438

Accessories

Handheld programmer, Intrinsically safe, EEx ia
HART modem/USB
(for use with a PC and SIMATIC PDM)

7ML1930-1BK

7MF4997-1DB

One metallic cable gland M20x1.5,
rated -40 ... +80 °C (-40 ... +176 °F), HART²⁾

7ML1930-1AP

One metallic cable gland M20x1.5,
rated -40 ... +80 °C (-40 ... +176 °F),
PROFIBUS PA³⁾

7ML1930-1AQ

One general purpose polymeric cable gland
M20x1.5, rated -40 ... +80 °C (-40 ... +176 °F)

7ML1930-1AM

SITRANS RD100, loop powered display -
see Chapter 7

7ML5741-...

SITRANS RD200, universal input display with
Modbus conversion - see Chapter 7

7ML5740-...

SITRANS RD300, dual line display with totalizer
and linearization curve and Modbus conversion -
see Chapter 7

7ML5744-...

SITRANS RD500 web, universal remote monitoring
solution for instrumentation - see Chapter 7

7ML5750-...

For applicable back up point level switch -
see point level measurement section

- 1) Available with communication option 2 only
- 2) Product shipped with plastic cable gland, rated to -20 °C.
If -40 °C rating required, then metallic cable gland is recommended.
- 3) Available with enclosure option 2 only

Dimensional drawings

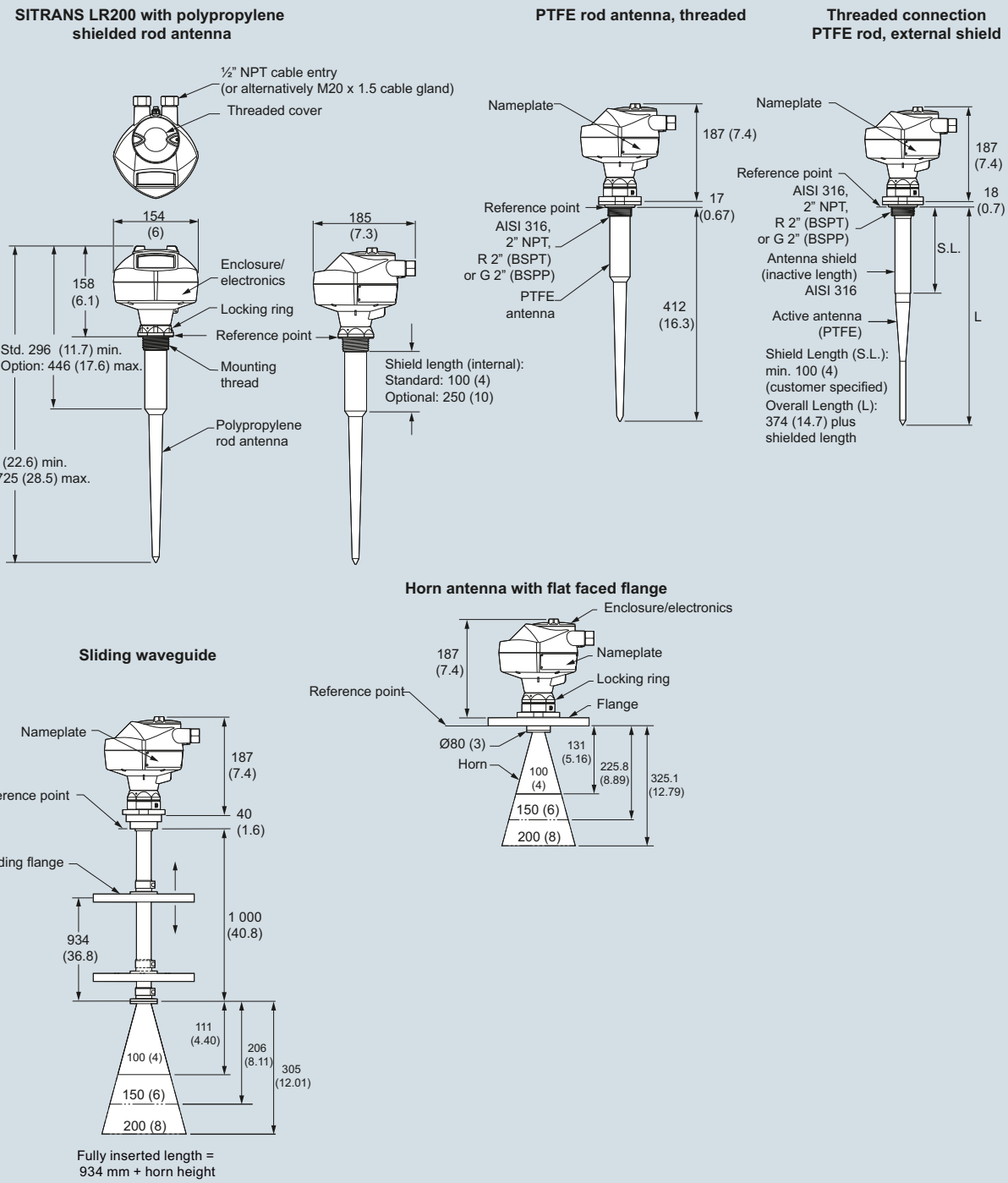

SITRANS LR200, dimensions in mm (inch)

Level Measurement

Continuous level measurement - Radar transmitters

SITRANS LR200

Schematics

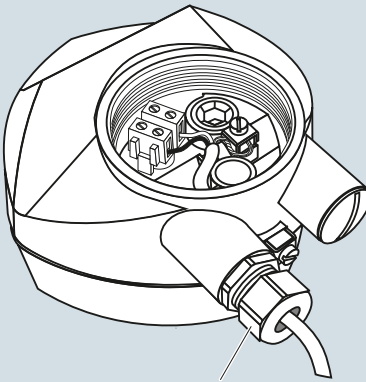

Gland

Connect the wires to the terminals as shown: the polarity is identified on the terminal block.

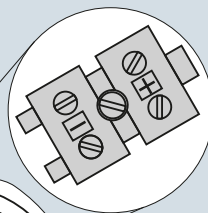
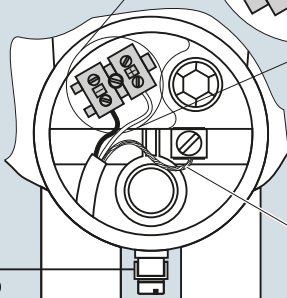
Shield for HART and PROFIBUS PA intrinsically safe versions only.

Hand programmer

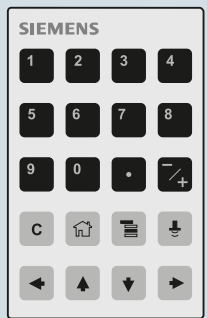

Part number:
7ML1930-1BK

Notes:

1. DC terminal shall be supplied from an SELV source in accordance with IEC 1010-1 Annex H.
2. All field wiring must have insulation suitable for rated input voltages.
3. Use shielded twisted pair cable (14 ... 22 AWG) for HART version.
4. Separate cables and conduit may be required to conform to standard instrumentation wiring practices or electrical codes.

SITRANS LR200 connections

Integration



Antenna configurations for SITRANS LR200

Technical specifications

Antenna Types	Flat Faced Flange with Rod	Shielded Rod	Horn (4", 6", 8" sizes available)
Connection type	Flat faced flange nominal pipe sizes 50, 80, 100, 150 mm (2, 3, 4, 6 inch)	Threaded 2" NPT, R 2" (BSPT), G 2" (BSPP) or flat faced flange nominal pipe sizes 80, 100 mm (3, 4 inch)	Flat faced flange nominal pipe sizes 50, 80, 100, 150 mm (2, 3, 4, 6 inch)
Wetted parts	PTFE	PTFE, 316L stainless steel, FKM o-ring	316L stainless steel, PTFE, FKM o-ring
Extensions	50 or 100 mm (2 or 4 inch) PTFE or UHMW-PE	100, 150, 200 or 250 mm (4, 6, 8 or 10 inch) standard shield length	Use waveguide for extensions to 6 m (20 ft) long
Dielectric constant	> 3	> 3	> 3
Insertion length (max.)	41 cm (16.3 inch)	Variable	Variable with extension
Purging option (liquid or gas)	No	No	Yes
Sliding waveguide option for digesters¹⁾	Yes	No	Yes
Weight²⁾	6.5 kg (14.3 lb)	5.0 kg (11 lb)	7.5 kg (16.5 lb)

¹⁾ Maximum pressure 0.5 bar g at 60 °C (7.25 psi g at 140 °F)

²⁾ Not including extensions, includes SITRANS LR200 and smallest process connection

Level Measurement

Continuous level measurement - Radar transmitters

SITRANS LR200 Antennas

Characteristic curves

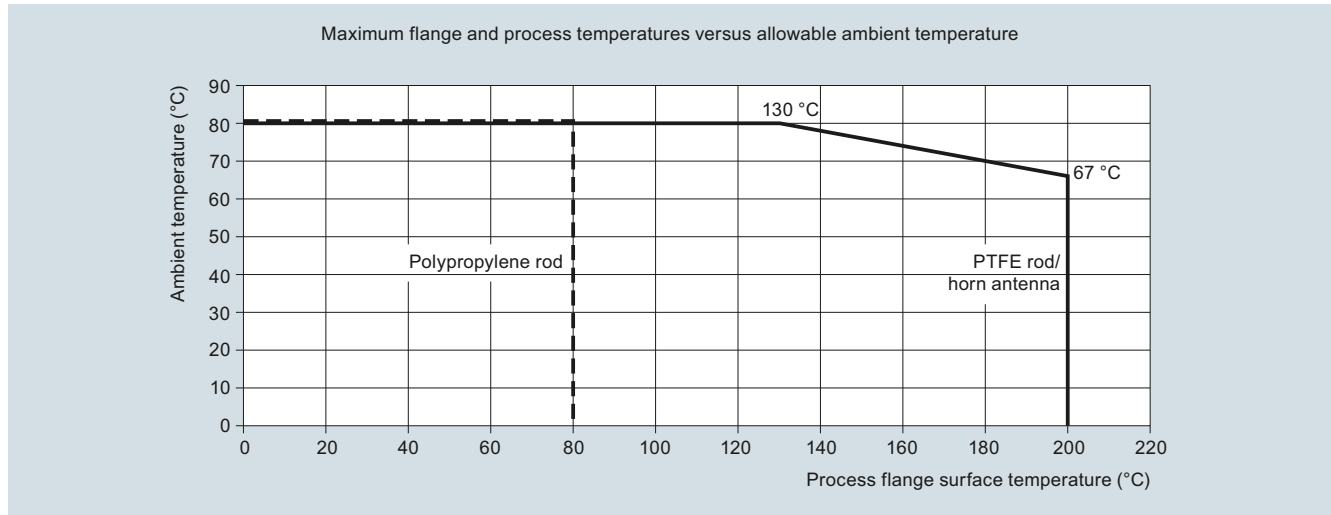

SITRANS LR200 Ambient/Process Flange Surface Temperature Curve

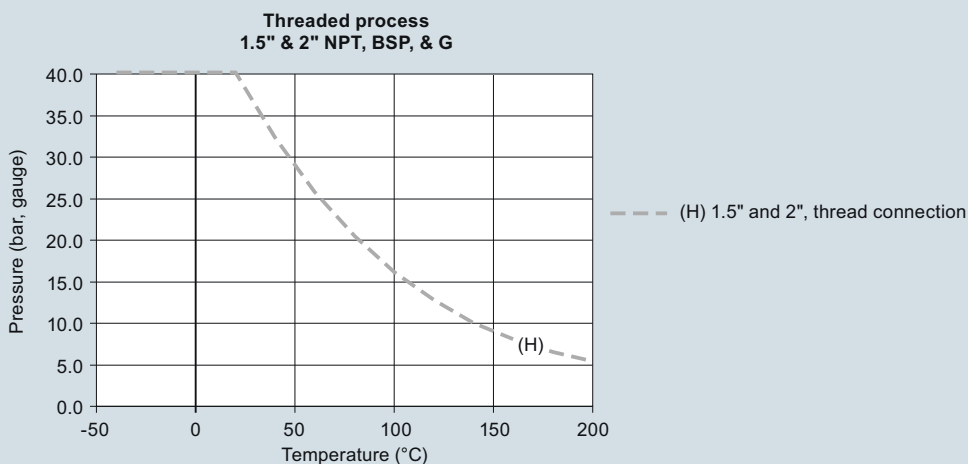
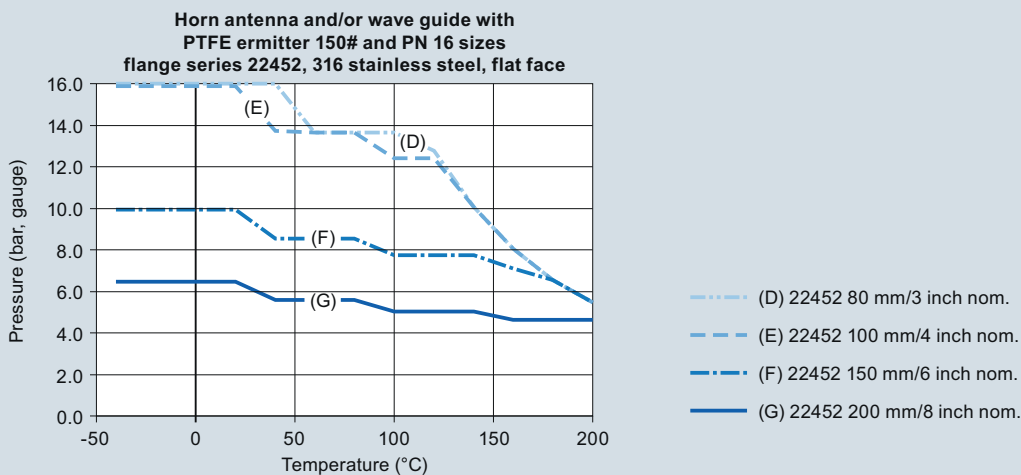
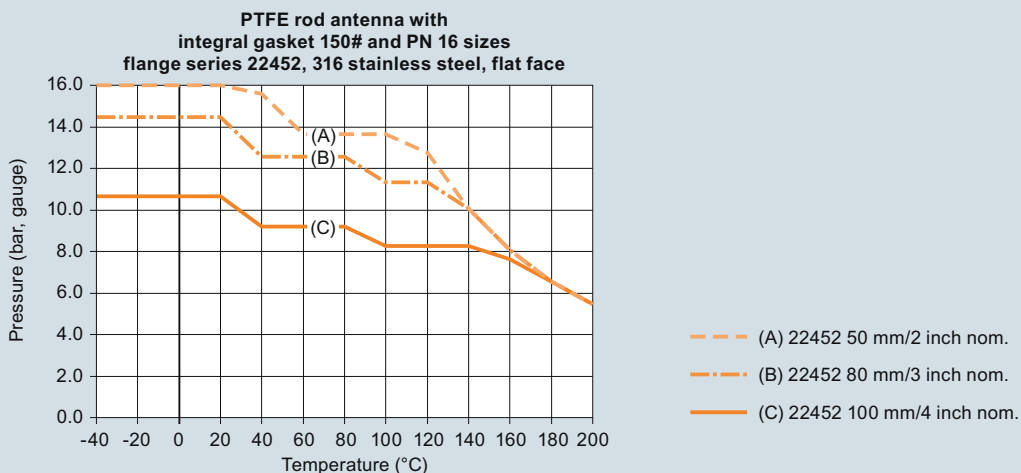

SITRANS LR200 Process Pressure/Temperature derating curves



Level Measurement

Continuous level measurement - Radar transmitters

SITRANS LR200 Specials

Selection and ordering data

SITRANS LR200 Specials

	Article No.
<p>SITRANS LR200 PROFIBUS PA Aluminum Enclosure Kit with electronics and covers (7ML5422, 7ML5423, 7ML5424, 7ML5425), calibrated for use with standard rod antenna</p> 	
SITRANS LR200 aluminum enclosure with board stack, LUI display, 5.8 GHz, M20 cable inlet, approval option E, with PROFIBUS PA communication, no process connection. ⁵⁾	A5E01483420
SITRANS LR200 aluminum enclosure with board stack, LUI display, 5.8 GHz, M20 cable inlet, approval option E, with PROFIBUS PA communication, no process connection. ⁵⁾	A5E01483440
SITRANS LR200 aluminum enclosure with board stack, LUI display, 6.3 GHz, M20 cable inlet, approval option C, with PROFIBUS PA communication, no process connection. ⁵⁾	A5E01483456
SITRANS LR200 aluminum enclosure with board stack, LUI display, 6.3 GHz, NPT cable inlet, approval option C, with PROFIBUS PA communication, no process connection. ⁵⁾	A5E01483547
SITRANS LR200 aluminum enclosure with board stack, LUI display, 5.8 GHz, NPT cable inlet, approval option E, with PROFIBUS PA communication, no process connection. ⁵⁾	A5E01483559
<p>SITRANS LR200 HART aluminum enclosure kit with electronics and covers (7ML5422, 7ML5423, 7ML5424, 7ML5425), calibrated for use with standard rod antenna</p> 	
SITRANS LR200 aluminum enclosure with board stack, LUI display, 5.8 GHz, M20 cable inlet, approval option A, with HART communication start-up at < 3.6 mA, no process connection. ⁵⁾	A5E02956419
SITRANS LR200 aluminum enclosure with board stack, LUI display, 5.8 GHz, M20 cable inlet, approval option E, with HART communication start-up at < 3.6 mA, no process connection. ⁵⁾	A5E02956420
SITRANS LR200 aluminum enclosure with board stack, LUI display, 5.8 GHz, M20 cable inlet, approval option G, with HART communication start-up at < 3.6 mA, no process connection. ⁵⁾	A5E02956421
SITRANS LR200 aluminum enclosure with board stack, LUI display, 5.8 GHz, M20 cable inlet, approval option H, with HART communication start-up at < 3.6 mA, no process connection. ⁵⁾	A5E02956422

SITRANS LR200 Specials

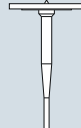
	Article No.
SITRANS LR200 aluminum enclosure with board stack, LUI display, 5.8 GHz, NPT cable inlet, approval option A, with HART communication start-up at < 3.6 mA, no process connection. ⁵⁾	A5E03617085
SITRANS LR200 aluminum enclosure with board stack, LUI display, 6.3 GHz, NPT cable inlet, approval option B, with HART communication start-up at < 3.6 mA, no process connection. ⁵⁾	A5E03617086
SITRANS LR200 aluminum enclosure with board stack, LUI display, 5.8 GHz, NPT cable inlet, approval option C, with HART communication start-up at < 3.6 mA, no process connection. ⁵⁾	A5E03617087
SITRANS LR200 aluminum enclosure with board stack, LUI display, 6.3 GHz, NPT cable inlet, approval option E, with HART communication start-up at < 3.6 mA, no process connection. ⁵⁾	A5E03617088
<p>SITRANS LR200 Horn Antenna Kits with mounting screws (no emitter supplied)</p> 	
80 mm (3 inch) horn antenna kit	PBD:25500K02A
100 mm (4 inch) horn antenna kit	PBD:25500K03A
150 mm (6 inch) horn antenna kit	PBD:25500K05A
200 mm (8 inch) horn antenna kit	PBD:25500K07A
<p>SITRANS LR200 Extension Kits for Horn Antenna with mounting screws</p>	
100 mm (4 inch) extension kit for horn antenna	PBD:25501K0100A
150 mm (6 inch) extension kit for horn antenna	PBD:25501K0150A
200 mm (8 inch) extension kit for horn antenna	PBD:25501K0200A
250 mm (10 inch) extension kit for horn antenna	PBD:25501K0250A
500 mm (20 inch) extension kit for horn antenna	PBD:25501K0500A
1 000 mm (40 inch) extension kit for horn antenna	PBD:25501K1000A
<p>SITRANS LR200 Flanged Rod Antenna Kit with 316L stainless steel flat faced flanges</p> 	
Flanged PTFE rod antenna kit, 2" ASME, 150 lb. See drawing 51003 on http://www.siemens.com/radar ¹⁴⁾	PBD: 51003K020AAAA
Flanged PTFE rod antenna kit, DN 50 PN 16. See drawing 51003 on http://www.siemens.com/radar ¹⁴⁾	PBD: 51003K050AJAA
Flanged PTFE rod antenna kit, JIS 10K DN 50. See drawing 51003 on http://www.siemens.com/radar ¹⁴⁾	PBD: 51003K050AOAA

Level Measurement

Continuous level measurement - Radar transmitters

SITRANS LR200 Specials

SITRANS LR200 Specials

Article No.

SITRANS LR200 PTFE Rod Antenna Kit with 316L stainless steel 1½" pipe thread process connection



PTFE rod antenna kit, 1½" NPT 316L stainless steel process connection, FKM O-ring; See drawing 51004 on <http://www.siemens.com/radar>⁴⁾

PBD:
51004K1AAA

PTFE rod antenna kit, R 1½" (BSPT), EN 10226 316L stainless steel process connection, FKM O-ring; see drawing 51004 on <http://www.siemens.com/radar>⁴⁾

PBD:
51004K2AAA

PTFE rod antenna kit, 1½" G 316L stainless steel process connection, FKM O-ring; see drawing 51004 on <http://www.siemens.com/radar>⁴⁾

PBD:
51004K3AAA

SITRANS LR200 PTFE Rod Antenna Kit with 316L stainless steel 2" pipe thread process connection



PTFE rod antenna kit, 2" NPT 316L stainless steel process connection, FKM O-ring; see drawing 51005 on <http://www.siemens.com/radar>⁴⁾

PBD:
51005K1AAA

PTFE rod antenna kit, R 2" (BSPT), EN 10226 316L stainless steel process connection, FKM O-ring; see drawing 51005 on <http://www.siemens.com/radar>⁴⁾

PBD:
51005K2AAA

PTFE rod antenna kit, 2" G 316L stainless steel process connection, FKM O-ring; see drawing 51005 on <http://www.siemens.com/radar>⁴⁾

PBD:
51005K3AAA

SITRANS LR200 Specials

Article No.

SITRANS LR200 PTFE Rod Antenna Kit (100 mm shield) with 316L stainless steel 2" pipe thread process connection



PTFE rod antenna shielded kit, 2" NPT 316L stainless steel process connection, FKM O-ring, 100 mm 316L stainless steel shield. See drawing 51002 on <http://www.siemens.com/radar>³⁾⁴⁾

PBD:
51002K0100AAA

PTFE rod antenna shielded kit, R 2" (BSPT), EN 10226 316L stainless steel process connection, FKM O-ring, 100 mm 316L stainless steel shield. See drawing 51002 on <http://www.siemens.com/radar>³⁾⁴⁾

PBD:
51002K0100BAA

PTFE rod antenna shielded kit, 2" G 316L stainless steel process connection, FKM O-ring, 100 mm 316L stainless steel shield. See drawing 51002 on <http://www.siemens.com/radar>³⁾⁴⁾

PBD:
51002K0100CAA

SITRANS LR200 Horn Antenna Kit with 316L stainless steel flat faced flange, with PTFE emitter (without waveguide)

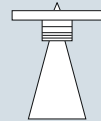

Horn antenna kit, 2" ASME 316L stainless steel flange 3" horn, PTFE emitter¹⁾⁴⁾

PBD:
51006K020AAAA

Horn antenna kit, 2" ASME 316L stainless steel flange 4" horn, PTFE emitter¹⁾²⁾

PBD:
51006K020AABA

Horn antenna kit, 2" ASME 316L stainless steel flange 6" horn, PTFE emitter¹⁾²⁾

PBD:
51006K020AACA

Horn antenna kit, 2" ASME 316L stainless steel flange 8" horn, PTFE emitter¹⁾²⁾

PBD:
51006K020AADA

Horn antenna kit, DN 50 PN 16 316L stainless steel flange 80 mm horn, PTFE emitter¹⁾²⁾

PBD:
51006K050AJAA

Horn antenna kit, DN 50 PN 16 316L stainless steel flange 100 mm horn, PTFE emitter¹⁾²⁾

PBD:
51006K050AJBA

Horn antenna kit, DN 50 PN 16 316L stainless steel flange 150 mm horn, PTFE emitter¹⁾²⁾

PBD:
51006K050AJCA

Horn antenna kit, DN 50 PN 16 316L stainless steel flange 200 mm horn, PTFE emitter¹⁾²⁾

PBD:
51006K050AJDA

Level Measurement

Continuous level measurement - Radar transmitters

SITRANS LR200 Specials

SITRANS LR200 Specials

Article No.

SITRANS LR200 PTFE flanged rod antenna kit with 316L stainless steel shield and 316L stainless steel flat faced flange



PTFE shielded rod antenna kit, flanged, 3" ASME 150 lb 316L stainless steel flange, 100 mm 316L stainless steel shield.¹⁾⁴⁾

PBD:
51014K0100AAA

PTFE shielded rod antenna kit, flanged, DN 80 PN 16 316L stainless steel flange, 100 mm 316L stainless steel shield.¹⁾⁴⁾

PBD:
51014K0100EJA

PTFE shielded rod antenna kit, flanged, 3" ASME 150 lb 316L stainless steel flange, 150 mm 316L stainless steel shield.¹⁾⁴⁾

PBD:
51014K0150AAA

PTFE shielded rod antenna kit, flanged, DN 80 PN 16 316L stainless steel flange, 150 mm 316L stainless steel shield.¹⁾⁴⁾

PBD:
51014K0150EJA

PTFE shielded rod antenna kit, flanged, 3" ASME 150 lb 316L stainless steel flange, 200 mm 316L stainless steel shield.¹⁾⁴⁾

PBD:
51014K0200AAA

PTFE shielded rod antenna kit, flanged, DN 80 PN 16 316L stainless steel flange, 200 mm 316L stainless steel shield.¹⁾⁴⁾

PBD:
51014K0200EJA

PTFE shielded rod antenna kit, flanged, 3" ASME 150 lb 316L stainless steel flange, 250 mm 316L stainless steel shield.¹⁾⁴⁾

PBD:
51014K0250AAA

PTFE shielded rod antenna kit, flanged, DN 80 PN 16 316L stainless steel flange, 250 mm 316L stainless steel shield.¹⁾⁴⁾

PBD:
51014K0250EJA

SITRANS LR200 Specials

Article No.

PTFE paste

Kit, PTFE paste, Tube, 250 mL

PBD:51036065

Cable gland

One polymeric cable gland M20x1.5, rated -20 ... +80 °C (-4 ... +176 °F) for General Purpose and ATEX EEx e

7ML1930-1AN

One metallic cable gland M20x1.5, rated -40 ... +80 °C (-40 ... +176 °F), HART

7ML1930-1AP

One metallic cable gland M20x1.5, rated -40 ... +80 °C (-40 ... +176 °F), PROFIBUS PA

7ML1930-1AQ

Please contact ceg.smpi@siemens.com for special requests.

- 1) Available in flange sizes including ASME, DIN and JIS: please contact ceg.smpi@siemens.com.
- 2) Available with no pressure rating
- 3) Available in other shield lengths: please contact ceg.smpi@siemens.com.
- 4) Available with Pressure rating; serial number of original unit required with completed Application Questionnaire found on page 4/193.