

Ultrasonic switch

Pointek ULS200

Quick Start Manual · 03/2013



Milltronics

SIEMENS

Pointek ULS200 Quick Start Manual

This manual outlines the essential features and functions of Pointek ULS200. We strongly advise you to acquire the detailed version of the manual so you can use your device to its fullest potential. The complete manual can be downloaded from the product page of our web site at: www.siemens.com/pointek. The printed manual is available from your local Siemens representative.

Copyright Siemens AG 2013. All Rights Reserved	Disclaimer of Liability
We encourage users to purchase authorized bound manuals, or to view electronic versions as designed and authored by Siemens Milltronics Process Instruments. Siemens Milltronics Process Instruments will not be responsible for the contents of partial or whole reproductions of either bound or electronic versions.	While we have verified the contents of this manual for agreement with the instrumentation described, variations remain possible. Thus we cannot guarantee full agreement. The contents of this manual are regularly reviewed and corrections are included in subsequent editions. We welcome all suggestions for improvement. Technical data subject to change.

MILLTRONICS is a registered trademark of Siemens Milltronics Process Instruments.

Contact SMPI Technical Publications at the following address:

Technical Publications
Siemens AG
Siemens Milltronics Process Instruments
1954 Technology Drive, P.O. Box 4225
Peterborough, Ontario, Canada, K9J 7B1
Email: techpubs.smpi@siemens.com.

European Authorized Representative

Siemens AG
Industry Sector
76181 Karlsruhe
Deutschland

Safety Guidelines

Warning notices must be observed to ensure personal safety as well as that of others, and to protect the product and the connected equipment. These warning notices are accompanied by a clarification of the level of caution to be observed.



WARNING: relates to a caution symbol on the product, and means that failure to observe the necessary precautions can result in death, serious injury, and/or considerable material damage.



WARNING¹: means that failure to observe the necessary precautions can result in death, serious injury, and/or considerable material damage.

Note: means important information about the product or that part of the operating manual.

¹ This warning symbol is used when there is no corresponding caution symbol on the product.

Pointek ULS200

! WARNING: Changes or modifications not expressly approved by Siemens Milltronics could void the user's authority to operate the equipment.

Notes:

- Pointek ULS200 is to be used only in the manner outlined in this manual, otherwise protection provided by the equipment may be impaired.
- This product is intended for use in industrial areas. Operation of this equipment in a residential area may cause interference to several frequency based communications.

Pointek ULS200 is an ultrasonic based process level switch providing high or low switch action on liquids or solids. The sensor is ETFE or PVDF allowing it to be used in a wide variety of industries. Pointek ULS200 is used to measure liquids, slurries, and fluid materials, as well as chemicals and plugged chute detection.

Pointek ULS200 contains an ultrasonic transducer and temperature sensing element. The transducer emits a series of ultrasonic pulses. Each pulse is reflected as an echo from the material and sensed by the transducer. Pointek ULS200 processes the echo using Siemens' proven Sonic Intelligence® techniques. Filtering is applied to help discriminate between the true echo from the material and the false echoes from acoustical and electrical noises and agitator blades in motion. The time for the pulse to travel to the material and back is temperature compensated and then converted into distance for display and relay actuation.

The Pointek ULS200 is an excellent primary detection device, but should not be used as a backup device. For backup devices use a contacting technology such as the Pointek CLS 200.

Specifications

AC Version

Power

- 100 to 230 V AC, + 15%, 50/60 Hz, 12 VA (5W) max.

Fuse

- Slow-Blow, 0.25 A, 250 V AC

Output

- repeatability: 0.25% of full range
- resolution: 3 mm (0.1")
- relay²: 2 Form C (SPDT) contacts, rated max. 5A @ 250 V AC / 30 V DC non-inductive; min. 10 mA @ 5 V DC

DC Version

Power

18 to 30 V DC, 3 W¹

Output

- repeatability: 0.25 % of full range
- resolution: 3 mm (0.1")
- relay²: 2 Form C (SPDT) contacts, rated max. 5 A @ 30 V DC non-inductive; min. 10 mA @ 5 V DC
- OR
- transistor: 2 transistor switches, rated 100 mA maximum at 48 V DC

1. See *Power* on page 8, for minimum supply voltage required with DC version.
2. See *Interface* on page 7, for operation up to 48 V DC.

Environmental

- location: indoor/outdoor
- altitude: 2000 m max
- ambient temperature: - 40 to 60 °C (- 40 to 140 °F)
- * - 20 °C (-5 °F) if metal mounting
- relative humidity: suitable for outdoor (Type 6/NEMA 6/IP67 enclosure)
- installation category: II
- pollution degree: 4

Process Pressure

- 0.5 bar (7.25 psi) max.

Switching Range

- liquids: 0.25 to 5 m (0.8 to 16.4 ft)
- solids: 0.25 to 3 m (0.8 to 9.8 ft)

Memory

- non-volatile EEPROM

Programming

- 2 keys

Temperature Compensation

- built-in to compensate over the operating range

Display

- LCD
- three 9 mm (0.35") digits for reading of distance between sensor face and material, multi-segment graphic for operation status

Electronics/Enclosure

- termination: terminal block, 2.5 mm² (14 AWG) solid 1.5 mm² (16 AWG) stranded, maximum
- material: plastic
OR
epoxy coated aluminum with gasket
- ingress protection: Type 6/NEMA 6/IP67¹
- cable inlet: 2 x ½" NPT or 2 x PG 13.5

Transducer

- material: ETFE or PVDF copolymer
- mounting: threaded: 2" NPT, 2" BSPT, or 2" G
optional flange adapter, to 3" ASME, DIN 65PN10, and JIS 10K3B

Approvals

See product nameplate.

Plastic enclosure:

- General CSA_{US/C}, FM, CE², C-TICK
- Hazardous
Non-incendive (Canada) CSA Class I, II, Div. 2, Gr. A, B, C, D, F, G
Class III

Epoxy coated aluminum enclosure:

- General CSA_{US/C}, FM, CE², C-TICK
- Hazardous
 - Explosion Proof (Canada) CSA Class I, Div. 1, Gr. A, B, C, D
Class II, Gr. E, F, G
Class III
 - Explosion Proof (USA) FM Class I, Div. 1, Gr. A, B, C, D T4
Class I, Zone 1, IIC T4
Class II, III, Div. 1, Gr. E, F, G T4
 - Flame Proof (Europe) ATEX II 2G EEx dmb IIC T5 Gb
 - Flame Proof (Australia) ANZEx Ex ds IIC T5 IP65/IP67 Class I, Zone 1
DIP A21 T5 IP65/IP67
 - Flame Proof (Brazil) INMETRO DNV 12.0074 X
Ex d mb IIC T5 Gb
IP65/IP67
-20 °C ≤ T_a ≤ +60 °C
DNV #OCP 0017
ABNT NBR IEC 60079-0:2008,
ABNT NBR IEC 60079-1:2009 e
ABNT NBR IEC 60079-18:2010

¹ Use only approved, suitable size hubs for watertight applications.

² EMC performance available upon request.

Installation

! WARNINGS:

- **Materials of construction are chosen based on their chemical compatibility (or inertness) for general purposes. For exposure to specific environments, check with chemical compatibility charts before installing.**
- **Explosion hazard. Substitution of components may impair suitability for Class I, Division 2 applications.**
- **This product can only function properly and safely if it is correctly transported, stored, installed, set up, operated, and maintained.**
- **The user is responsible for the selection of bolting and gasket materials which will fall within the limits of the flange and its intended use, and which are suitable for the service conditions.**

Note: Installation shall only be performed by qualified personnel and in accordance with local governing regulations.

Mounting Location

Recommendations:

- Ambient temperature within -40 to $+60$ °C (-40 to $+140$ °F), -20 °C (-4 °F) if metal mounting.
- Easy access for viewing the display and programming via two push buttons.
- An environment suitable to the housing rating and materials of construction.
- Keep the sound path perpendicular to the material surface.

Precautions:

- Avoid proximity to high voltage or current wiring, high voltage or current contacts, and to variable frequency motor speed controllers.
- Avoid interference to the sound path from obstructions or from the fill path.

The sound path should be:

- perpendicular to the monitored surface
- clear of rough walls, seams, rungs, or other obstructions
- clear of the fill path

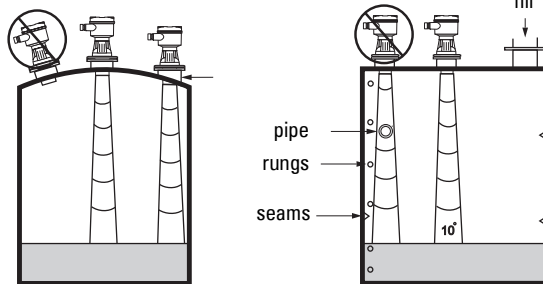

Mounting Instructions

Note: Ideally, mount Pointek ULS200 so that the face of the transducer is at least 250 mm (9.84") above the highest anticipated level.

Pointek ULS200 is available in three thread types: 2" NPT, 2" BSPT, or 2" G.

Before inserting Pointek ULS200 into its mounting connection, ensure that the threads are of the same type to avoid damaging them. Simply screw Pointek ULS200 into the process connection, and hand tighten.

Dimensions

Standard

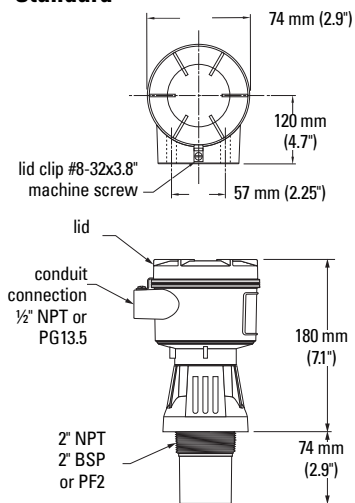

The Pointek ULS200 can be fitted with the optional 75 mm (3") flange adapter for mating to 3" ANSI, DIN 65 PN10 and JIS 10K 3B flanges.

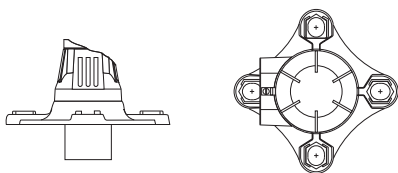

Sanitary

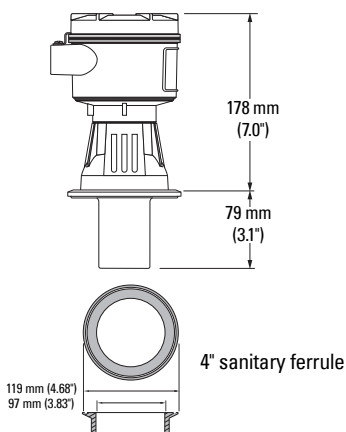

Mount the Pointek ULS200 onto the top of the tank's sanitary ferrule. Secure mating by surrounding the joining with the optional clamp. Hand tighten the adjusting nut. Do not use a wrench.

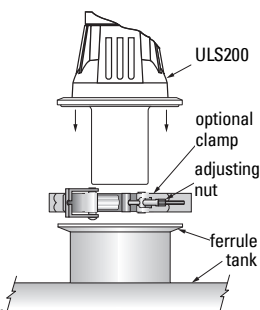

Notes:

- Dimensions are nominal and may vary with material types.
- Non-metallic enclosure does not provide grounding between connections.
- Use grounding type bushings and jumpers.
- For CSA/FM approved Hazardous Location Models, see Siemens drawing 0-9440026Z-DI-A.

Interface

AC

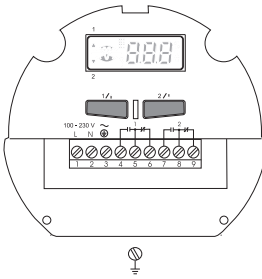

DC - relay output

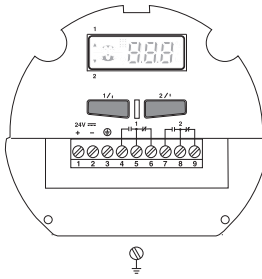

DC - transistor output

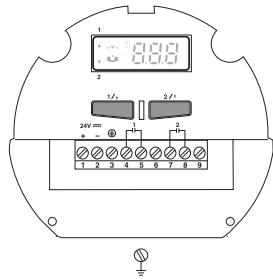

Relay output - DC contact voltage and current limits

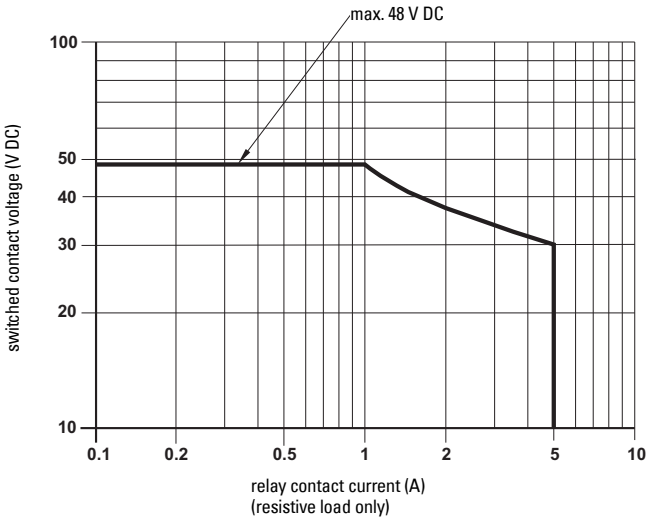

WARNINGS:



The DC input terminals shall be supplied from a source providing electrical isolation between the input and output, in order to meet the applicable safety requirements of IEC 61010-1



All field wiring must have insulation suitable for rated voltages.

Notes:

- A circuit breaker or switch in the building installation, marked as the disconnect switch, shall be in close proximity to the equipment and within easy reach of the operator.
- Relay contact terminals are for use with equipment having no accessible live parts and wiring having insulation suitable for at least 250 V.
- This product is susceptible to electrostatic shock. Follow proper grounding procedures.

Wiring

Relay output

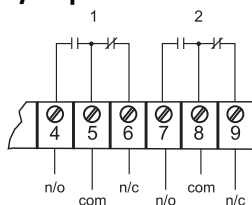

All relays shown are in their de-energized (unpowered state).

Optional transistor output - DC version only

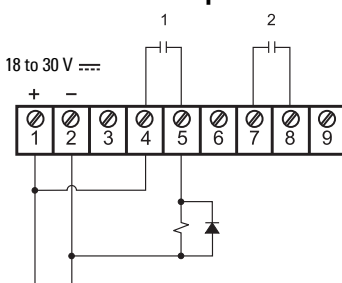

Power

AC version

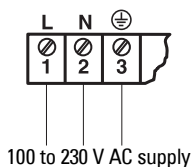

DC version

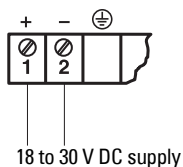

Minimum supply voltage - DC relay version

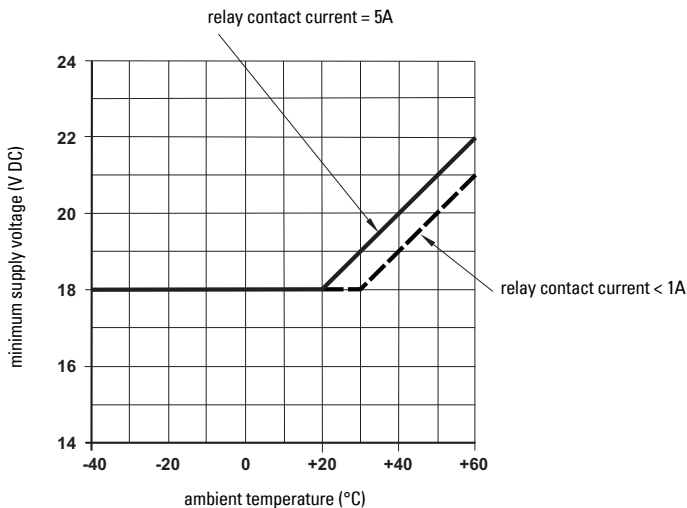

Operation

Start Up

With the ULS200 correctly installed (or aimed at a wall 0.25 to 5 m away), apply power and view the start up sequence. It will light all possible LED values, show product revision number, product model number, and will enter run mode. Then, the display shows the measurement of the distance from the transducer face to the material level in the units indicated.

Display / Operation Status

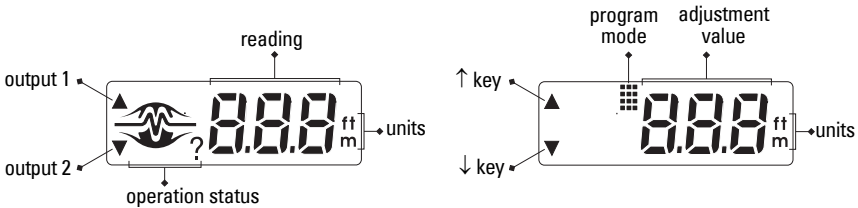

Operation Status - Run Mode



- echoes are valid and within range.



- echoes are lost due to poor conditions or out of range. This may be typical in applications where there are deep vessels and the material level is normally out of range. Refer to Troubleshooting.



- extended loss of echo period. Operation has gone into fail-safe. Refer to Troubleshooting.

Quick Start

To set a basic high/low application where you can easily adjust the measured distance, use the method below. The Pointek ULS200 relays are preset as: relay 1 = alarm 1, high alarm at 0.25 m; relay 2 = alarm 2, low alarm at 5.00 m.

To change the setpoints by reference method, set the material or target to the distance as displayed. Press the '1 / ↑' or '2 / ↓' key. The display shows the current setpoint function and value. Press the alarm key a second time so the ULS200 changes the setpoint to the value currently being measured. After viewing or changing the setpoint, the Pointek ULS200 reverts to the run mode.

relay 1

1. Position the unit so that it reads 0.75 m.
2. Press 1 / ↑

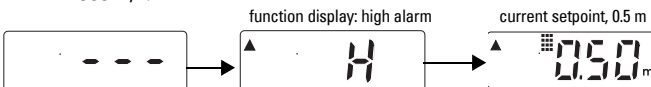

3. Press 1 / ↑

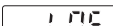

4. Once installed, the unit will register a high alarm at 0.75 m from the sensor face. If Loss of Echo  appears, complete steps 1 to 3 again.

relay 2

1. Position the unit so that it reads 3.50 m.
2. Press 2 / ↓

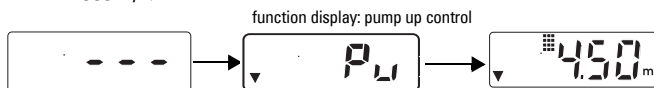

3. Press 2 / ↓



4. Once installed, the unit will register a low alarm at 3.50 m from the sensor face. If Loss of Echo **LOE** appears, complete steps 1 to 3 again.

Applications

Pointek ULS200 is designed for use as a process level switch. The local display is used only as an aid during start up. The instrumentation interface is comprised solely of the two relay outputs. Switching applications are based on the relay functions adjustment.

Notes:

- All level setpoints must be within the device's range (3 m for solids, 5 m for liquids).
- Range applies to the device's switching capability, not to the process range of the material.

The outputs can be set to function in the desired mode.

Application	Function	Relay 1	Relay 2
High / Low level switch	*1	High Alarm	Low Alarm
High level switch with two height alarms	2	High Alarm	High Alarm
Low level switch with two height alarms	3	Low Alarm	Low Alarm
High level switch with loss of echo alarm	4	High Alarm	LOE Alarm
Low level switch with loss of echo alarm	5	Low Alarm	LOE Alarm
Pump down control with low level alarm	6	Pump Down	Low Alarm
Pump down control with high level alarm	7	Pump Down	High Alarm
Pump up control with low level alarm	8	Pump Up	Low Alarm
Pump up control with high level alarm	9	Pump Up	High Alarm
Pump down control with loss of echo alarm	10	Pump Down	LOE Alarm
Pump up control with loss of echo alarm	11	Pump Up	LOE Alarm
Pump up control and Pump down control	12	Pump Down	Pump Up
Dual pump down control	13	Pump Down	Pump Down
Dual pump up control	14	Pump Up	Pump Up

* Factory setting

Alarm: the relay de-energizes to set the alarm 'ON'

Control or Pump: the relay energizes to set the device 'ON'

High Level Alarm Switch

Application: an alarm output, high and/or high-high alarm, when the process material rises to a high level.

Application Notes: It is common to apply the switch on vessels where the material is normally below the unit's range. Under such a condition the Pointek ULS200 loses echo, and if prolonged, defaults to fail-safe operation. As this would be a normal occurrence, it is not advisable to select the fail-safe high option. If the high level switch is being applied to a vessel within the 3 or 5 m range, a loss of echo and ensuing fail-safe condition would not be a common occurrence and the fail-safe default could be used if required.

fail-safe = 1, 2, or 3

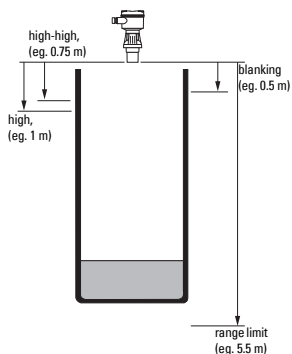

fail-safe = 2 or 3

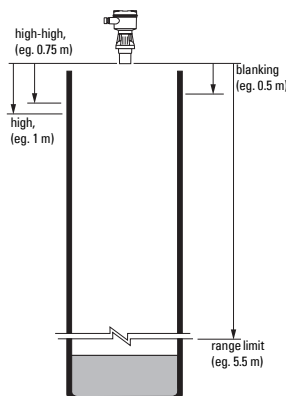

Application Adjustments

alarm	2 - high / high-high
function	alarm
alarm	4 - high / Loss of Echo (LOE)
setpoint	set the high and / or high-high alarms to the desired values
fail-safe mode	1 - high, except if the process range is beyond the ULS200 operating range (3/5 m) 2 - low 3 - hold

High / Low Level Alarm Switch

Application: high and low level alarms.

Application Notes: If the material can fall below the unit's range, the Pointek ULS200 loses the echo, and if prolonged, defaults to fail-safe operation. The fail-safe default should be set to suit the application.

fail-safe = 1, 2, or 3

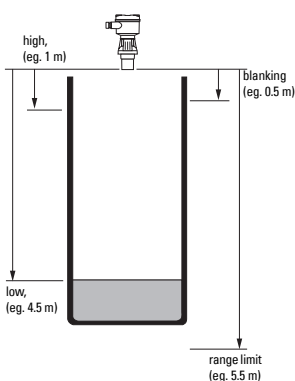

fail-safe = 2 or 3

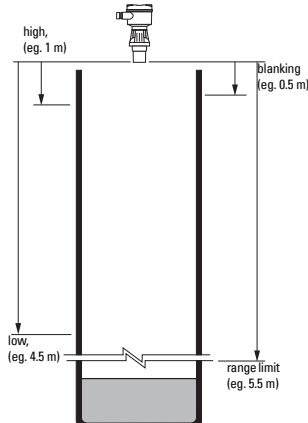

Application Adjustments

alarm	1 - high / low
function	alarm
alarm	set the high and/or low alarms to the desired values
setpoint	
fail-safe mode	1 - high 2 - low 3 - hold

Low Level Alarm Switch

This application uses the Pointek ULS200 to provide one or two low level alarms.

If the material can fall below the unit's range, the Pointek ULS200 loses the echo, and if prolonged, defaults to fail-safe operation. The fail-safe default should be set to suit the application.

fail-safe = 1, 2, or 3

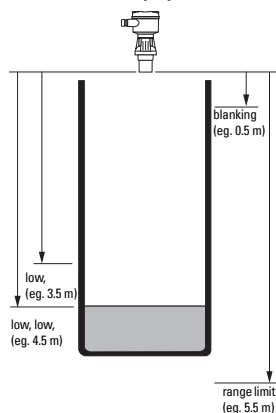

fail-safe = 2 or 3

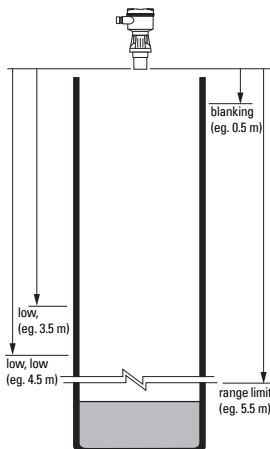

Application Adjustments

alarm function	3 - low / low-low alarm
alarm setpoint	5 - low / LOE alarm
fail-safe mode	1 - high 2 - low 3 - hold

Dual Pump Control

This application uses Pointek ULS200 to provide a control output when the process material rises to a high level.

Typically, wet wells are used to temporarily hold storm and/or waste water. When the water surface reaches a high level setpoint, the wet well is pumped down. The process material will be pumped down by the deadband value to another setpoint where the control will turn off.

Relay function 13: Dual Pump Down

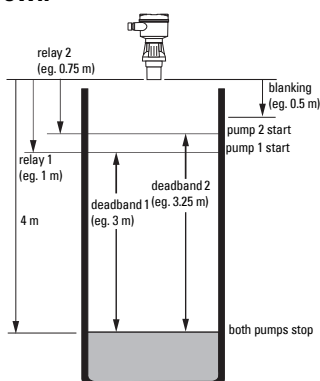

Application Adjustments

relay function	6 - high control / low alarm 7 - high control / high alarm 10 - high control / LOE alarm 13 - high control / high control
relay setpoints	set to desired values
deadband values	referenced from relay setpoints (distance from Pump Start setpoint to Pump Stop setpoint)

Pump Control with Level Alarm

This application uses the Pointek ULS200 to provide pump control and one level alarm.

If the material reaches a control setpoint, the well is pumped down or up respectively. If the material reaches an alarm setpoint, the alarm will sound until the material moves beyond the deadband value.

Relay Function 8: Pump Up Control with Low Alarm

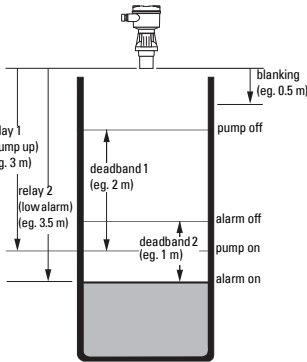

Application Adjustments

relay function	6 - high control / low alarm 7 - high control / high alarm 8 - low control / low alarm 9 - low control / high alarm 10 - high control / LOE alarm 11 - low control / LOE alarm
alarm setpoint	set the low alarm to the desired values

Operating Adjustments

To access the operating adjustments, simultaneously press both keys repeatedly until the desired adjustment is obtained. A viewing period of the adjustment value is initiated. During this time the value can be changed by pressing either the 'up' or 'down' key. After viewing or changing, operation automatically reverts to the run mode.

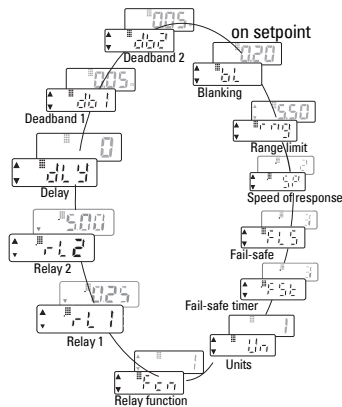

To adjust a value:

1. Press both operating buttons

select adjustment (eg. relay 1)

current value (eg. 0.5 m)

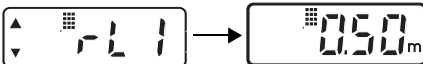

2. Press 1 / ↑

change value (eg. increase to 0.75 m)

new value (eg. new setpoint 0.75 m)

after 6 sec. delay, return to run mode



Output Function



The alarms can be set to function in the desired mode.

Function	Relay 1	Relay 2
1*	high alarm	low alarm
2	high alarm	high alarm
3	low alarm	low alarm
4	high alarm	LOE alarm
5	low alarm	LOE alarm
6	pump down	low alarm
7	pump down	high alarm
8	pump up	low alarm
9	pump up	high alarm
10	pump down	LOE alarm
11	pump up	LOE alarm
12	pump down	pump up
13	pump down	pump down
14	pump up	pump up

* Factory setting

Function display:

high alarm	H
high-high alarm	HH
low alarm	L
low-low alarm	LL
loss of echo alarm	LOE
pump up control	PU
pump down control	PD

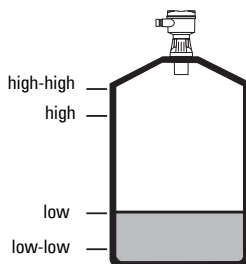

Setpoints



The setpoints can be set where reference levels, either from the material in the vessel or from a target, cannot be provided. This method can also be used to trim the output levels obtained by the Reference Method (Quick Start).

The setpoints are referenced from the face of the sensor. They should not be set at or above the blanking value, or at or below the range limit.

Factory Setting: Relay 1 = 0.5 m (1.64 ft)

Relay 2 = 4.50 m (14.76 ft)

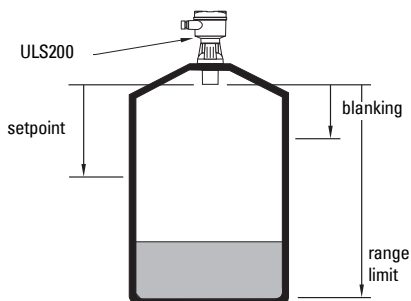

Relay Delay

Adjust the time delay, in seconds, from when the material reaches the relay level and the relay is actuated. If the material level withdraws from the setpoint level, the delay is reset to 0.

The set time delay applies to both relays and all functions except 'Loss Of Echo'.

Factory setting: 0 seconds.

Relay Deadband (Reset)

Deadband (hysteresis) prevents relay chatter due to material level fluctuations at the set point. These fluctuations are often waves or turbulence on a fluid's surface caused by agitators in the tank.

Once a relay is tripped, the detection level must move beyond the deadband value before it is reset. The direction in which the deadband is measured depends on the application of the relay. If the relay is for a high state then the deadband is measured below the set point. If the relay is for a low state then the deadband is measured above the set point. Refer to the diagram below.

Deadband 1 is used for Relay 1 and Deadband 2 is used for Relay 2. The deadband value is entered in the units selected, and applies to both relays and all alarm or control functions except 'Loss Of Echo'.

Factory setting: 0.05 m (0.16 ft)

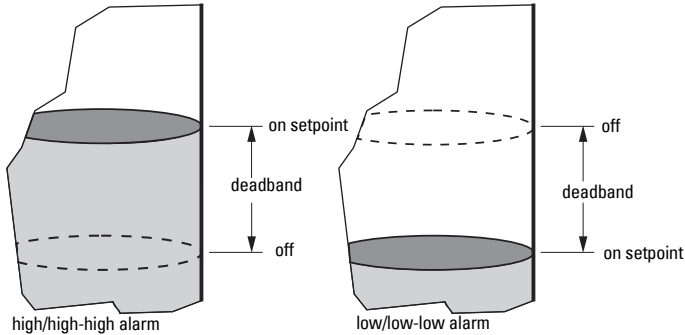

Blanking

Blanking is used to ignore the zone in front of the transducer where false echoes are at a level that interfere with the processing of the true echo. It is measured outward from the sensor face.

The minimum recommended blanking value is 0.25 m (0.82 ft) but can be increased in order to extend the blanking.

Factory setting: 0.20 m (0.66 ft)

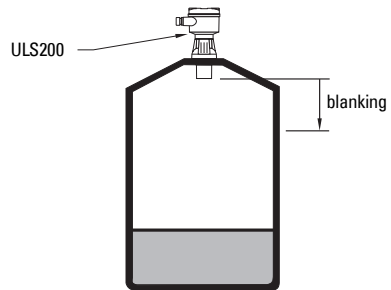

Range Limit



The range limit is the distance at which measurements are ignored. Generally this refers to the bottom of the container being measured. If a measurement is detected beyond the range limit it results in a Loss Of Echo (LOE) reading. The result of this reading is determined by the Fail-Safe Mode, see page 17 for more information.

Factory setting: 5.50 m (18.0 ft)

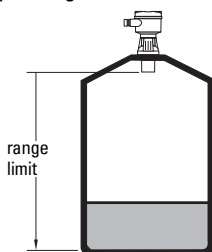

0 to 3 m vessels (solids)
0 to 5 m (liquids)

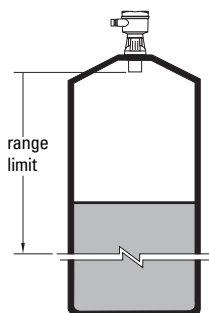

greater than 3 m vessels (solids)
greater than 5 m (liquids)

Speed of Response



The speed of response adjustment allows the user to collectively set a number of operating parameters.

measurement response: is the limit to which the Pointek ULS200 is able to keep up with rates of change.

If the Pointek ULS200 measurement cannot keep up with the rate of level change, set the adjustment from **1** to **2**.

If the Pointek ULS200 still cannot keep up with the rate of level change, set the adjustment option to **3**. Avoid choosing an option that is too fast for your application.

agitator discrimination: discriminates between agitator blades in motion and the material (target) surface.

filter: discriminates between false echoes from acoustical and electrical noise and the material (target) surface.

fail-safe timer: establishes the 'Waiting' period from the time a loss of echo or operating fault condition starts until the fail-safe default is effected.

SP	measurement response	agitator discrimination	filter	FLS timer
1	0.3 m / min (0.1 ft / min)	on	on	10 min
2*	1 m / min (3.3. ft / min)	on	on	10 min
3	5 m / min (16.4 ft / min)	on	on	3 min
4	immediate	off	off	3 min

* Factory setting

Fail-Safe Mode

In the event that a loss of echo condition exceeds the fail-safe timer (speed of response variable), ? appears in the display; and if a relay is assigned to **LOE** (alarm function option), it is engaged. This function must be used with the Output Function on page 14.

fail-safe	mode	function		reading
		high and high-high	low and low-low	
1	high	on	off	hold
2	low	off	on	hold
3*	hold	hold	hold	hold

* Factory setting

Fail-Safe Timer

The fail-safe timer allows the user to vary the waiting period from the time of a loss of echo or operating fault condition begins, until the fail-safe default is effected. The waiting period is adjustable from 1 to 15 minutes, in 1 minute increments.

Units

The units of the measurement reading can be selected as follows:

- 1 = metres, m (Factory setting)
- 2 = feet, ft

The selected units are also applicable to the **Blanking** and **Relay** adjustments.

Troubleshooting



The echo is not reliable and Pointek ULS200 is waiting for a valid echo before updating the measurement.

Probable causes are:	Remedy
material or object in contact with sensor face	lower material level or raise Pointek ULS200
Pointek ULS200 is not perpendicular to the material surface	check Pointek ULS200 mounting if angle of repose is too steep, angle Pointek ULS200 mounting
change in level too fast	adjust speed of response
material out of range	acceptable on some high level switch applications
foam on liquid surface	mount Pointek ULS200 via stilling well or pipe
too much dust or interference from material filling	relocate Pointek ULS200
high level of vibration in the mounting structure	relocate Pointek ULS200 or limit vibration
material inside blanking zone or below range limit	adjust blanking or range limit
?	Fail-safe default after prolonged Loss Of Echo. Investigate the probable causes listed above.

Maintenance

Pointek ULS200 requires no maintenance or cleaning.

Unit Repair and Excluded Liability

For detailed information, please see the inside back cover.

Instructions specific to hazardous area installations (Reference European ATEX Directive 94/9/EC, Annex II, 1/0/6)

The following instructions apply to equipment covered by certificate number SIRA 00ATEX1205:

1. The equipment may be used with flammable gases and vapours with apparatus group IIC and temperature class T5.
2. The equipment is certified for use in an ambient temperature range of -20 to +60 °C (-4 to +140 °F).
3. The equipment has not been assessed as a safety related device (as referred to by Directive 94/9/EC Annex II, clause 1.5).
4. Installation and inspection of this equipment shall be carried out by suitably trained personnel in accordance with the applicable code of practice (EN 60079-14 and EN 60079-17 in Europe).
5. Repair of this equipment shall be carried out by suitably trained personnel in accordance with the applicable code of practice (e.g. EN 60079-19 within Europe).
6. Components to be incorporated into or used as replacements in the equipment shall be fitted by suitably trained personnel in accordance with the manufacturer's documentation.
7. The certification of this equipment relies upon the following materials used in its construction:

Aluminum alloy T356 T6 (main enclosure) and A356 T6 (lid)

GE Lexan 943A polycarbonate

Two-part epoxy encapsulant

Silicon based coating

Santoprene 111-55 gasket

Master Bond Polysulphide EP21LPT or Dow Corning 3-4207 encapsulant (transducer)

ETFE (transducer)

Epoxy syntactic foam (transducer)

If the equipment is likely to come in contact with aggressive substances, then it is the responsibility of the user to take suitable precautions that prevent it from being adversely affected, thus ensuring that the type of protection is not compromised.

Aggressive substances: e.g. acidic liquids or gases that may attack metals, or solvents that may affect polymeric materials

Suitable precautions: e.g. regular checks as part of routine inspections or establishing from the material's data sheet that it is resistant to specific chemicals.

8. Equipment Marking:

The equipment marking contains at least the information on the product nameplate, shown on the inside front cover of this manual.

9. Special Condition for Safe Use: The apparatus must only be supplied from a circuit containing a suitable rate fuse having a breaking capacity of at least 4000 A.