

DR Graphic Recorder GR Series Advanced Graphic Recorders Specifications

43-TV-03-19, June 2015



Crystal Clear Display

- 12.1" High Resolution Digital Colour LCD (TFT)
- XGA Resolution (1024 x 768 pixels)
- Clear and intuitive operation
- Industrial rugged Touch Screen with rapid navigation
- Custom Screens

Comprehensive Connectivity

- 10/100 Ethernet (DHCP), Web, Email
- FTP, TCP/IP and RS485 Modbus Protocol
- Modbus Master and Slave (option)
- USB ports for keyboard and mouse



Data Storage

- On-board non-volatile internal memory - up to 4GB
- Removable Secure Digital (SD) card and USB storage
- No moving parts - all solid state Flash memory

Security Stringent - Total Data integrity

- Password Protection - 21CFR Part 11
- ESS - Extended Security System
- Password Network Synchronisation

Plus..

- Health Watch for preventative maintenance
- Remote Access - Advanced Software Data Analysis at your PC and Remote Viewing
- Independent Chart and Logging speeds
- Global Language Support
- Rapid review and replay of data at recorder
- Approvals - CE, cCSAus, cULus, NEMA Type 4X / IP66 option
- Up to 50Hz (20 msec) Logging
- Up to 16 Analogue Inputs
- Reports - System generated
- Concurrent Batch mode
- AMS2750 Process Capabilities

Recorder Function

- Honeywell's DR Graphic recorder provides flexible electronic data acquisition and recording in a high functionality shallow format designed to fit in shallow cabinets or surface mount applications.
- Up to 16 Analogue inputs with at least 1GB standard of available on-board memory plus additional removable storage media.
- The DR Graphic recorder uses a digital colour TFT LCD screen to provide easy to read displays with wide viewing angles for the best all around data viewing.
- The touch screen operator interface provides fast, easy access to the recorder menus making set up and data analysis quick and efficient. Navigation through the menus and text entry are direct and intuitive.

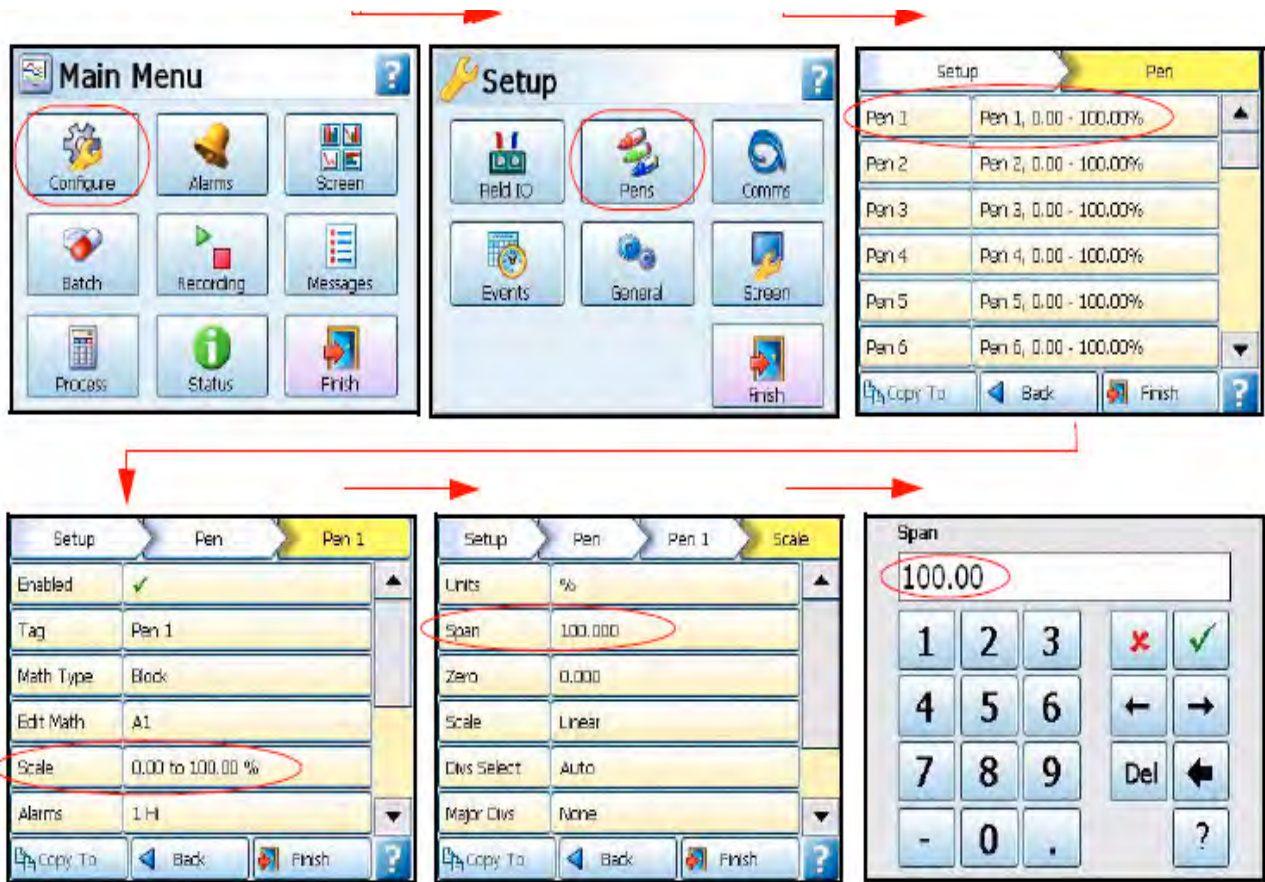

Example of a recorder menu path from the Main Menu to Pen Scale configuration with clear rapid navigation

Features

Display

- **12.1” High Resolution Colour Active TFT** - with more than 256,000 colours makes it easy to interpret process data and take action with the intuitive bar charts, digital values, trends or customised displays. A screen saver function can be set from 1 to 720 minutes to extend the life of the backlight.
- **Touch Screen** - the heavy duty durable touch screen provides easy data entry and rapid navigation through the menus.

Internal memory / Logging rate =1 sec			
Pens	1GB	2GB	4GB
4	1000d	2000d	4000d
8	500d	1000d	2000d
16	250d	500d	1000d

- **Help Files** - A complete contextual help system can be accessed and visualised on the screen of the recorder.

Communications

- **Ethernet Connectivity** - the Ethernet (DHCP standard) connection, with support for various protocols, provides unlimited connectivity to local area networks (LANs). The standard Ethernet interface makes networking of the recorder to a LAN or the world wide web fast and convenient. Dynamic Host Configuration Protocol (DHCP) automatically acquires the settings (IP address) for network communications from a DHCP server.
- **RS485 Modbus** - the RS485 connection allows process data to be transferred to other devices, or to record data received in MODBUS RTU protocol (slave mode only).
- **Simple Network Time Protocol (SNTP)** - The recorder can be synchronized over the Ethernet network via a SNTP client or synchronise other recorders via a Server.
- **Web Server** - with the recorder connected to a LAN, all process variables, alarm and messages can be viewed from an internet browser; values are automatically refreshed.

Data Storage

Internal Data Storage – 1GB to 4GB of expandable internal non-volatile flash memory is available for data storage and chart history.

Data Export - Removable SD Card and USB flash storage device provides multiple data storage alternatives. Data is stored in a secure binary encrypted format, with the recorder's configurations, providing added security of the data files.

Removable SD Card and USB flash storage devices



External USB Devices

The recorder has two USB host ports, for attaching external USB devices such as a keyboard, mouse or a USB datastorage key. The keyboard and mouse can be used to navigate the recorder's screen along with text entry.

Security

- **Total Data Integrity** - data is stored in secure encrypted files making it easy to retrieve the data dependent on process information. Data is automatically recognised without having to remember file names.
- **Password Protection** - Up to 4 levels of password protection with up to 50 different users are available. Multiple levels of password protection and an audit trail of actions enhance the security of the data.
- **Extended Security System (option) - ESS** provides extended features including entry of unique User ID's and associated passwords, time-out of password entry, password expiration, and traceability of user actions. ESS is compatible with the requirements of 21CFR part 11.
- **Password Network Synchronisation** – Password can be synchronized over the network, a recorder can be designated as a master of a password group and other recorders can be added to that group as slaves, the master will ensure all passwords are synchronized with all recorders in its group.

Modbus Master/Slave

The recorder can communicate with up to 32 slave devices on both RS485 and/or Ethernet at a maximum poll rate of 1 second (slowest 1 hour), with each slave up to 8 “transactions” can be performed where a transaction can be retrieving 1 or more registers from a slave or sending one or more Pens to a slave.

Remote Viewer

Extends the user interface of the recorder onto the desktop PC. Providing remote viewing of the unit launched from a web browser. Full remote control is available as an option. Compatible with Microsoft™ Internet Explorer 6, 7, 8, and 9. For Internet Explorer 10 or higher use Remote Display Tool for viewing and taking control of recorder screen.

Reports

Reports can be generated manually or on a periodical basis using event system to show daily/weekly/monthly totals, max mins, averages etc., the reports can be printed direct from the recorder, e-mailed as attachments or exported to external media. The reports will be in RTF format for use in MS Word or other compatible word processors.

Events/Counters

Certain conditions or operations can be set up and logged according to the time and date of the occurrence. Subsequently events can be reviewed in a list or represented on a graph. Up to 16 User Counters are available and can be used as a part of the Events system. User Counters can be set up as a Cause or an Effect of an Event. Preset Markers can be configured and used when applying a Mark to the chart through the event system, the alert system or manually.

Concurrent Batch Mode (option)

Batch enhances the management of data collected in non-continuous process, known as batch processing, used in thermal treatment, sterilization, and food processing and chemical reactions. In concurrent batch mode each batch is associated with a group of pens, so all pens within Group 1 will belong to the batch that is controlled by Group 1. Batch features include Pause chart when batch stopped, Batch Logging control, List driven data fields, Automated batch counters, Event driven batch control, Updated control and feedback, Batch mode State and Count in scripts/embedded variables.

AMS2750 Process Mode (option)

Provides on-line monitoring in the process recorder to alert the user to potential AMS2750 non-compliance issues. Monitors and alerts the user concerning - days until next SAT, days until next TUS, days until next control T/C change out and days until the recorder requires calibration. The recorder also provides an overview of T/C usage for all survey T/C's providing a colour coded early warning screen (5 day expiration).

AMS2750 TUS Mode (option)

The Multitrend GR recorder monitors a temperature uniformity survey and generates a data file that can be used to create a TUS report. It tracks a number of parameters during a TUS which includes the ramp time, the time between the first T/C entering dwell zone and the last T/C entering dwell zone, the point where all T/C's are stable and lie within the setpoint tolerance limits for the defined furnace class, the dwell time (minimum of 30 min.) for the survey, the maximum temperature value during the dwell period and the minimum temperature value during the dwell period. The on line TUS tracking screen shows the current status of a survey for up to 6 set points, furnace details, status, Min & Max TC readings, Max differences, MaxOvershoot, durations and the Class of furnace the survey met.

Standard features

- **CE Mark** - Conformity with 2006/95/EC, Low Voltage Directive and 2004/108/EC EMC Directive.
- **Common Relay Output** - A separate relay alarm output near the mains plug inside the unit can be set up as an alarm output.
- **Communications** - the recorder supports FTP, Modbus TCP/IP (slave mode), Web and Email over Ethernet (DHCP standard) communications port and Modbus RTU (slave mode) via an RS485 port. USB ports allow the use of an ASCII barcode reader. Email sent to your network connected PC triggered by an Alarm or an Event.
- **Language Support** - standard language prompts for English UK & US, French, German, Italian, Spanish, Brazilian, Polish, Hungarian, Slovakian, Czech, Turkish, Romanian, Russian, Portuguese, Greek, Chinese, Japanese, Korean and Bulgarian.
- **Logarithmic Scales** - all displayed scales can be set as linear or logarithmic.
- **Enclosure rating** - standard NEMA Type 3 / IP55 type front face protection. NEMA Type 4X / IP66 available as an option.
- **Pulse Inputs** -The 8 Digital I/O option card has 4 channels that can be set as pulse inputs (first 4 channels). The operating frequency for pulse inputs on the Digital I/O card is 1kHz max.
- **Fuzzy Logging** - this standard feature provides a unique method to increase the storage capacity of the recorder. The data is monitored to determine changes in process data; if no changes are observed data is logged periodically. If data is changing rapidly, it is recorded normally at the programmed rate. By not logging data that is static, data compression of up to 100:1 or more can be achieved saving valuable memory.
- **Rate up and rate down alarms** - Users can configure a rate of change in engineering units to be checked over a time period in seconds from 1 to 3600 (1 hour).
- **Security tag** - "wire seal provision" that provides added security by sealing the front door and internal wiring to prevent undetected entry to these areas of the recorder.
- **Independent Display Chart Speeds and Logging rates** - logging rates can be programmed completely separate from the chart display speed, allowing the data to be displayed and stored at the rates that best suits the application.
- **Soft Alarms** - 6 "software" alarms per pen are easily set up to display and record selected out-of-limit conditions. These can be tied to the relay or digital outputs to activate the user's external equipment.
- **USB Ports** - Two USB host ports for data and setup transfers or remote screen through these ports. Use these ports to attach external devices (keyboard or mouse) for direct interfacing with the recorder.
- **Replay with Zoom** -Select replay mode and zoom -in on a specific area on the screen. The data can easily be replayed at the recorder with the ability to "zoom". The touch screen makes it fast to review and analyze historical data. A "Jump" function allows you to go from any message list directly to the trend showing the occurrence of the alarm.
- **Dual Cursors in Replay** - Displays the time and date between two independently positioned cursors on a replay screen. Also provides digital readings and shows the max/min between the cursors.
- **Alert System** - Error messages can be displayed for serious errors such as connectivity problems or can be used as an early warning message system to notify the user on potential memory storage space availability.
- **Sound Effects** - Sound effects, used as an event effect the user can pick from a list of 20 different sounds these can be configured to play a single time or repeat continuously until a corresponding "stop" event is triggered for that sound. The sounds themselves can be replaced on the recorder with custom sounds loaded by the user.
- **User Variables** - Provides the user with the ability to set values for up to 32 variables that can be used in the maths and scripts. Values can be altered to effect calculations without having to change the configuration. User variables are non-volatile.

Options – Hardware

- **Alarm Card** - 4 or 8 outputs relay contacts SPCO 240V, 8 Digital I/O or 16 Digital I/O - SPNO 24VDC. Programmable alarm set points can be configured to activate up to 16 outputs.
- **Analogue Output** - 2 or 4 outputs available per card. Output type: 0-20mA or 4-20mA.
- **Nema 4X / IP66** – Nema Type 4X / IP66 protection available as an option.
- **Digital Input** - Two digital input options are available: 2 inputs on 8 channel Alarm card, 8 inputs on 8 Digital I/O card and 16 inputs on a 16 Digital I/O card. The digital inputs allow users to initiate, from a remote location via a dry contact closure, selected recorder functions.

- **Pulse Counting** - Up to four counting inputs per board, are available to count signals up to 25 kHz (max. 2 cards).
- **Approvals** – cCSAus, cULus approvals.
- **24VAC/DC Power Supply** - 20 to 55VDC / 20 to 30VAC
- **24VDC Transmitter Power Supply** - can supply up to 200mA to external transmitters.
- **Print Support** - Network printing from status, message and replay screens. Plus screen capture facility of process screens instantly using a basic USB standard PCL printer.

DR Graphic Standard Screens

Up to 20 screens displaying multiple combinations of Charts, Bars and Digitals can be configured, 4 examples of process screens and 2 non-process screens.

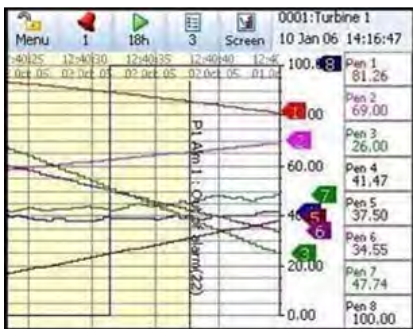
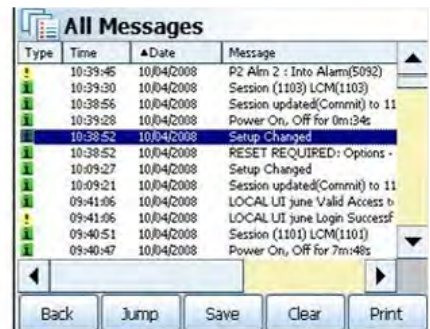

Chart and Digitals



8 Digitals



Messages screen (non-process)



Vertical chart, 4 horizontal bars, 4 digitals

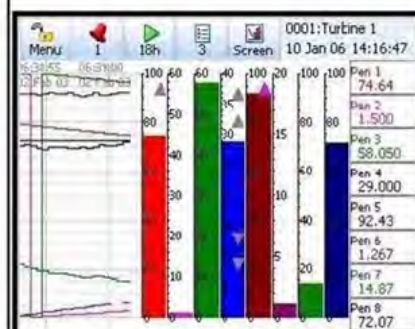

Horizontal chart, 8 vertical bars, 8 digitals



Circular format screen

Firmware Credit System

The credits system is a flexible way of adding to the recorder features without having to upgrade the firmware. Simply purchase a number of credits to cover your current and possible future requirements and the recorder will be delivered with the credits loaded.

Credits can be applied as desired to the Firmware functions until the total number of credits purchased has been used up. Additional credits can be purchased later if new features are to be activated and not enough credits are available to support these additional functions.

Firmware options are selected using the Model Selection Guide. Details of each firmware option are listed here.

Firmware option	Credit value	Description		
Full Maths	4	Full (Block) Math - this can handle math expressions that can consist of expressions up to 100-characters in length. (Note 1)		
Full Maths with Scripting	6	A powerful multi-line scripting ability available to solve complex state based applications. Eg.: "If .. X happens, then Y will happen, else.. Z will occur. (Note 1)		
Fast Scanning mode	5	For fast processes, the scan rate and recording of the data can be set for up to 50 times per second (20ms) for up to 8 inputs.		
Totalisers/ Sterilisation calculation	4	Each pen can be associated with a totaliser. Using extra pens, the totalised values can be displayed and recorded; multiple totals can be calculated out of the same variable (weekly, monthly, etc.). The totaliser function can handle Fo and Po sterilisation calculation. (Note 1&4)		
Custom Screens	4	Import custom built screens that have been created in GR Series Screen Designer. (Note 2)		
Reports	3	Generate reports manually or using the event system to show daily/weekly/monthly Totals, Max/ Mins, Averages, Current Value. Messages, Message Lists - Alarm, System, Diagnostic, Security & User, Counters, Digital Inputs, and Digital Outputs. Reports can be printed, e-mailed as an attachment or exported to external media in RTF format. Also batch report format to support batch operation.		
Events	6	<p>Events are certain conditions or operations that can be set up and logged according to the time and date of an occurrence. Subsequently events can be reviewed or displayed on a graph.</p> <table border="0"> <tr> <td style="vertical-align: top;"> <p>The Event Causes include:</p> <p>Alarms - Into/Out of and Alarm Ack Totals - Start/Stop/Reset/Reset and Start Digital Input - ON/OFF/State Change T/C Burnout Scheduled - Once/Interval/Specific Days/ Month End User Counters</p> <p>Max/Mins - Reset</p> <p>System - Power ON/Setup Change/ Internal Memory Low/Export Memory Low/ FTP Memory Low</p> <p>User Action - Mark Chart,</p> <p>Batch - Start/Stop/Pause.</p> <p>TUS - Start/Stop</p> <p>AMS2750 Timer -TC Timers/Process Timers</p> <p>TC Health Monitor</p> </td> <td style="vertical-align: top;"> <p>The Event Effects include:</p> <p>Mark Chart –User Defined/Preset Logging – Start/Stop</p> <p>Totaliser – Start/Stop/Reset/Reset & Start,</p> <p>Digital Output – ON/OFF</p> <p>Alarm Acknowledge Emails, Screen Change, Print Screen, Counters – Reset/Increment</p> <p>Max/Min (Reset)</p> <p>Chart Control - Pause/Stop/Resume/ Clear/Prefill</p> <p>Clear All Messages, Delayed Event Script Timers – Start/Stop/Reset/Reset & Start Play Sound – Start/Stop</p> <p>Display Alert, Reports</p> <p>Batch – Start/Stop/Pause</p> <p>Update Tabular Readings</p> </td> </tr> </table> <p>Each event marker can be recorded for analysis using the Trend Manager Pro Software Suite. (Note 2)</p>	<p>The Event Causes include:</p> <p>Alarms - Into/Out of and Alarm Ack Totals - Start/Stop/Reset/Reset and Start Digital Input - ON/OFF/State Change T/C Burnout Scheduled - Once/Interval/Specific Days/ Month End User Counters</p> <p>Max/Mins - Reset</p> <p>System - Power ON/Setup Change/ Internal Memory Low/Export Memory Low/ FTP Memory Low</p> <p>User Action - Mark Chart,</p> <p>Batch - Start/Stop/Pause.</p> <p>TUS - Start/Stop</p> <p>AMS2750 Timer -TC Timers/Process Timers</p> <p>TC Health Monitor</p>	<p>The Event Effects include:</p> <p>Mark Chart –User Defined/Preset Logging – Start/Stop</p> <p>Totaliser – Start/Stop/Reset/Reset & Start,</p> <p>Digital Output – ON/OFF</p> <p>Alarm Acknowledge Emails, Screen Change, Print Screen, Counters – Reset/Increment</p> <p>Max/Min (Reset)</p> <p>Chart Control - Pause/Stop/Resume/ Clear/Prefill</p> <p>Clear All Messages, Delayed Event Script Timers – Start/Stop/Reset/Reset & Start Play Sound – Start/Stop</p> <p>Display Alert, Reports</p> <p>Batch – Start/Stop/Pause</p> <p>Update Tabular Readings</p>
<p>The Event Causes include:</p> <p>Alarms - Into/Out of and Alarm Ack Totals - Start/Stop/Reset/Reset and Start Digital Input - ON/OFF/State Change T/C Burnout Scheduled - Once/Interval/Specific Days/ Month End User Counters</p> <p>Max/Mins - Reset</p> <p>System - Power ON/Setup Change/ Internal Memory Low/Export Memory Low/ FTP Memory Low</p> <p>User Action - Mark Chart,</p> <p>Batch - Start/Stop/Pause.</p> <p>TUS - Start/Stop</p> <p>AMS2750 Timer -TC Timers/Process Timers</p> <p>TC Health Monitor</p>	<p>The Event Effects include:</p> <p>Mark Chart –User Defined/Preset Logging – Start/Stop</p> <p>Totaliser – Start/Stop/Reset/Reset & Start,</p> <p>Digital Output – ON/OFF</p> <p>Alarm Acknowledge Emails, Screen Change, Print Screen, Counters – Reset/Increment</p> <p>Max/Min (Reset)</p> <p>Chart Control - Pause/Stop/Resume/ Clear/Prefill</p> <p>Clear All Messages, Delayed Event Script Timers – Start/Stop/Reset/Reset & Start Play Sound – Start/Stop</p> <p>Display Alert, Reports</p> <p>Batch – Start/Stop/Pause</p> <p>Update Tabular Readings</p>			
Health Watch/ Maintenance	2	The recorder keeps track of important "life actions" for improved diagnostics and preventative maintenance notification. Including Powered On, Last powered On, Time On since power up, Total On time, Total Off time, Longest Off time, Lithium cell life, Backlight life left at 100% brightness, Compact Flash insertions, Hi/Lo CJC value (Hi & Lo temps), Analogue In last factory/user cal, Relay operations.		

Firmware option	Credit value	Description
Batch/Groups	5	The Batch function allows the user to segment portions of data for further analysis. The Batch function manages sections of data. Concurrent batches are now associated with a group of pens. The pens with in each group will belong to the batch that is controlled by that group. Batches can be controlled through the event system and batch markers are setup by the user and are used to identify and analyse batches of data. Supports up to 6 concurrent batches.
Counters	3	User Counters can be set up and used as a part of the Events system to count an occurrence. Other counters are available depending on hardware availability. Eg. Alarm, Event, Digital Input, Relay Output and Pulse counters.
Modbus Master	10	Modbus master enables the recorder to communicate with up to 32 Slave devices on both Ethernet and RS485. The recorder itself can also act as a slave device while also being a master. Modbus master can also be used in conjunction with OPC to enable the recorder to act as a communication bridge.
Remote Viewer	3	Extends the user interface of the recorder onto the desktop PC. Providing full remote control of the unit launched from a web browser.
Email	3	Setup email accounts to send the following: When an Alarm is triggered or an Email can be sent as a part of an Event occurring, such as: Alarms - In/Out/Ack , Totaliser – Start, Stop or Reset, Digital Inputs – On, Off or State change, TC Burnout – on a specific Analogue Input channel, Scheduled Events – Once, Interval, Specific days, Month End.
Pwd Net Sync	5	Password Network Synchronisation. Password can be synchronised over the network, a recorder can be designated as a master of a password group and other recorders can be added to that group as slaves, the master will ensure all passwords are synchronised with all recorders in its group. Maximum number of password slaves in one group is 31.
AMS2750 Process	5	AMS2750 Process activates the Process Mode screen and the AMS2750 process configuration menus for furnaces and sensors in accordance with AMS2750 specification, including Thermocouple tracking.
AMS2750 TUS	10	AMS2750 TUS activates the TUS screen and the AMS2750 TUS configuration menus for furnaces and sensors in accordance with AMS2750 specification, including Thermocouple tracking. All of the survey information can be exported to a Report Generating tool.
Secure Comms	3	Secure Comms (WSD) is a web service that can run on devices and conforms to the Devices Profile for Web Services (DPWS). Recorder device will host web service and have server certificate installed on it. Desktop clients will have root authority certificate of server in trusted root certificates. Whenever client connects to WSD service SSL handshake will take place and on successful handshaking secure communication channel will be established and data flowing between these two end points will be encrypted.
Hardware Lock	2	Uses the password permission areas to lock access to the hardware configuration functionality leaving some areas view only.
Extra Pens	2	4 extra pens to store and display totalised values, results of calculations, etc. Maximum is up to 16 extra pens for the GR recorder.

Notes

1. Additional pens ("Extra Pens") can be used to display and store the results of calculations, totalisers, variables imported via communications, or to store values.
2. Custom Screens must be built using GR Series Screen Designer (.lay).
3. Event markers are required to automatically reset the totalisers, for example on a periodic basis or on an external condition. (Not necessary if the totalisers are reset manually).
4. Specification table for Sterilisation: The definition of Fo/Po is the sterilisation/pasteurisation time in minutes required to destroy a stated number of organisms with a known z at temperature T. For example, "F18/250" represents the time in minutes required to destroy a stated number of organisms at a temperature of 250°F (121.11 °C) with a z = 18 degrees F. F values are used to compare the sterilizing values of different processes, however, F values cannot be compared unless the z values are the same. When temperature is not specified (for example, F = 8.6) it is understood that the temperature is 250°F (121.11 °C); the subscript O (as in the term Fo = 7.4) is used to indicate that the z = 18 degrees F and the temperature is 250°F (121.11 °C).

The TrendManager Pro Software Suite

The TrendManager Pro Software Suite complements the capabilities of the “GR Series” recorders by providing the benefits of viewing, configuration, network communications, database management, data analysis and report generation using a personal computer. It ties the process together, providing for real-time communications with the recorders through a Local Area Network (LAN).

TrendViewer

TrendViewer - is the standard software provided with the recorder that displays and prints data imported from the storage media used by the recorder.

TrendManager Pro

TMP is an advanced data analysis/archiving software package, providing full configuration of the recorders. TrendManager Pro is a stand-alone package that delivers to the user total recorder configuration, allowing the user to archive, graph, print and export data. TrendManager Pro also allows files to be exported using comma separated variables (CSV) format that can be imported in most computer software.

TrendServer Pro

TSP is a fully network aware software package for real-time viewing and archiving of data with communications to the recorder. It supports all the capabilities of TrendManager Pro plus real-time data acquisition, FTP (File Transfer Protocol) and web browser access. TrendServer Pro provides secure multi-level, multi-user access to the recorder data by various departments with security. Standard features of TrendServer Pro include data archive tools, graphing, print import and export data facilities.

TrendServer Pro with OPC Server - provides the same functions as the TrendServer Pro but includes the added function of an integrated OPC Server to allow easy interfacing to third party HMI software packages that support an OPC Client. This provides a real-time interface between servers and clients. **Modbus Profile Configuration Tool** - this is a tool that comes as part of the TrendServer Pro software that allows the user to set up Modbus Device Profiles for use by the Communications Server. It allows the user to set up other Modbus devices other than the **GR Series** recorders to get real time data into TrendServer Pro.

Enhancements

Communications Server

This is supplied with **TrendServer Pro**. It manages real-time communications, distributed access to the stored data. It is also available with a 2.0 DA compliant OPC Server to make it easier to interface third party HMI software packages that support an OPC Client. The Communication Server provides security for the transmission and storage of process data.

Database Management Tool

This software application works with TrendManger Pro and TrendServer Pro to provide safe administration of data with tools to archive, sort, move, copy and delete the data stored in local and remote databases. The Database Management Tool software is supplied with TrendServer Pro.

IQOQ Protocol Document (TrendServer Pro only.)

Custom built IQOQ reports can be generated based on the configuration of the recorder. The configuration can be validated as a process of confirming that a piece of equipment or process meets the stated requirements to produce a regulated product.

Report Generation Tool - AMS2750

PC software that uses a TUS data file generated by the Multitrend GR recorder to generate a temperature uniformity survey report. It produces a report that documents the uniformity performance of a furnace based on the AMS2750 specification. AMS2750 is the specification that covers pyrometric requirements for thermal processing equipment used for heat treatment.

GR Series Screen Designer

This is a separate software package that enables the user to design unique display layouts for transfer to the recorder's screen. Screen layouts can be created using any combination of indicators such as Trending Charts, Digital Panel Meters (DPM) and Bar graphs. Flexibility allows each type of indicator to have elements of its appearance changed to create an individual presentation. The GR Series Screen Designer software package is compatible with Minitrend GR, Multitrend GR and DR Graphic recorders. Layouts can be transferred on to single or multiple recorders of the same type, which contributes to continuity and standardization of process data.

Minimum System requirements for TrendViewer:-	Minimum System requirements for TrendServer Pro, TrendManager Pro and GR Series Screen Designer:
Supports: Microsoft Windows™ Windows 7 (32 bit – Professional and Ultimate Edition - 64 bit), Windows 8, Windows 2008 Server, Windows 2012 Server	Supports: Microsoft Windows™ Windows 7 (32 bit – Professional and Ultimate Edition - 64 bit), Windows 8, Windows 2008 Server, Windows 2012 Server
1 GHz Pentium processor or higher with a mouse, CD-ROM drive	1 GHz Pentium processor or higher with a mouse, CD-ROM drive
Monitor screen resolution 1024 x 768 recommended minimum, high colour	Monitor screen resolution 1024 x 768 recommended minimum, high colour
512 Mbyte of RAM	4GB RAM for generating IQOQ report
16 bit colour graphics, 24 bit recommended (Screen Designer only)	16 bit colour graphics, 24 bit recommended (Screen Designer only)
50 Mbyte free hard disk space	2 Gbyte Hard-drive free disk space
Flash card reader or USB port for X Series recorders SD card reader for GR Recorders	Flash card reader or USB port for X Series recorders SD card reader for GR Recorders
3.5" floppy disk drive or PCMCIA for V5 recorders	3.5" floppy disk drive or PCMCIA for V5 recorders
	TCP/IP Installed
	Graphics Card & Direct-X control installed (Screen Designer)

Specification	Environmental and Operating Conditions			
	Reference	Rated	Extreme	Transport & Storage
Ambient Temperature	67 °F to 77 °F 19 °C to 25 °C	32 °F to 122 °F 0 °C to 50 °C	32 °F to 122 °F 0 °C to 50 °C	14 °F to 140 °F -10 °C to 60 °C
Relative Humidity (%RH)	50 to 65*	10 to 90*	5 to 90*	5 to 95*
Vibration: Frequency (Hz)	0	0 to 70	0 to 100	0 to 100
Acceleration (g)	0	0.1	0.2	0.5
Mechanical Shock				
Acceleration (g)	0	1	5	20
Duration (ms)	0	30	30	30
Mounting Position (Vertical)				
Tilted Forward	5°	40°	40°	Any
Tilted Backward	5°	65°	65°	Any
Tilted to Side (+/-)	5°	65°	65°	Any
Power Requirements				
Mains Voltage (Vrms)	120/240	100 to 240	90 to 264	N/A
Low Voltage AC (Vrms)	18 +/- 2	20 to 30	20 to 30	N/A
DC Voltages	24 +/- 2	20 to 55	20 to 55	N/A
Frequency (Hz)	50/60	47 to 63	47 to 63	N/A
Power Consumption	AC: <50VA (max), DC: <40W (max). Typical 25W			
Warm Up	30 minutes minimum			

* The maximum rating only applies up to 104 °F (40 °C). For higher temperatures, the RH spec is de-rated to maintain constant moisture content.

Specification	Design Attributes
Digital indicators and Display	<p><i>Display size and Type:</i> 12.1" diagonal, Digital Colour LCD (TFT) with Touch Screen Industrial grade with brightness adjustment and wide viewing angle</p> <p><i>Resolution:</i> XGA (1024 x 768 pixels).</p> <p><i>Screen Saver:</i> Set in minutes from 1 to 720, can be set to dim the screen or to switch off.</p> <p><i>Brightness adjustment:</i> Adjustable between 10 and 100%, default set to 80% brightness.</p> <p><i>Backlight life time:</i> 43,000 hours to half brightness when used at 100%, (67,000hr if used at 80%). Maximum luminosity 400 cd/m²</p> <p><i>Touch Screen life:</i> 1,000,000 touches</p>
Display Update Rate	Display values updated every second
Status Display	A status bar, at the top of the recorder's screen, displays the real-time icons of the recorder status, such as Recording Time left and alarm active.
Communications	Ethernet 10/100 base - T with RJ45 connector supporting Modbus/TCP, FTP, Internet, DHCP or fixed IP address. RS485 Modbus RTU (up to 115200 Baud Rate).
Mathematics	Basic Maths include Add, Subtract, Multiply, Divide, Modulo and power. Full Maths and Scripting (option) support up to 100 character free form math expression for each pen. For example SINE, COS, TAN, Log, Parenthesis (eg. A1 + A2), comm variables, free memory, and access to any data item variable (A1, P1, D1 etc.).
Internal USB Ports	Two internal USB host ports for data and setup transfers through these ports. External devices keyboard or mouse, Barcode reader, or external mass storage device. (USB 2.0 compliant)
Standard Screens and Custom Screens	Fully programmable display values in engineering units. Time & date stamp on every division. Sets of Standard screens are available to display data on a chart, digital reading, bargraphs or numerous combinations thereof. Screen properties can be modified on the recorder and customized to suit. Custom screens created in the Screen Designer software can be imported into the recorder for specialist applications. Custom Screen firmware option is required. Digital values displayed include alarms on bars, engineering units, pen name, tag, time and date, 20 character description and totalized values.
Power Requirements	<p><i>Voltage (VRMS):</i> 100VAC to 240VAC (auto select).</p> <p><i>Frequency:</i> 50/60Hz</p> <p><i>Optional instrument power voltage:</i> 20 to 55VDC/20 to 30VAC</p> <p><i>Typical VA:</i> <30VA</p> <p><i>Typical Consumption:</i> <25W</p>
Battery	Battery backed up for clock, Lithium battery Type CR 2032, 3.0V – 10 years life (Recorder powered), 1 year life, typical (Recorder unpowered).
Temperature Units	°C, °F, °K
Data Storage	<p><i>Removable Media:</i> SD Card, supports up to 32GB.</p> <p><i>Local Mass Storage Options (Removable Media):</i> USB memory key - no size restrictions but must be formatted (FAT, FAT16, TFAT, FAT32). USB hard drive - up to 120GB,</p> <p><i>Internal Data Buffer:</i> Non-volatile. 740MB (160 million acquisition values) upwards to 3.7GB (up to 800 million points)</p> <p><i>Setup and screens:</i> Stored internally on non-volatile memory</p> <p><i>Manual Saving:</i> Data saving by inserting compact flash card or USB memory stick</p> <p><i>Data Saving Period:</i> Related to log rate, number of pens, totals and alarms. Each pen is capable of its own independent storage rate. (20 ms to 60 h).</p> <p><i>Data Format:</i> Honeywell binary encoded format</p> <p><i>Recycling Mode:</i> Internal memory has FIFO (First In First Out) capability where the newest data over-writes the oldest data.</p>

Specification	Design Attributes
Common Relay Output (SPNC)	NC common alarm relay: Two contacts, normally open when the recorder is powered (no active alarms). Rating 24V, 1 Amp.
Password Protection	Multiple Administrator control of password setup and management with four levels of password protection for – Engineer, Supervisor, Technician, and Operator. Up to 50 different users are available. Password protection restricts user entry to the recorder set up and specific screens. Engineer – Highest access to all levels, Supervisor, Technician and Operator. Supervisor – 2nd highest level including Technician and Operator access Technician – 3rd level including Operator access Operator – 4th and lowest level of access.
Languages	English UK & US, French, German, Italian, Spanish, Brazilian, Polish, Hungarian, Slovakian, Czech, Turkish, Romanian, Russian, Portuguese, Greek, Chinese, Japanese, Korean and Bulgarian.
Recorder Identification	Status bar: Alternately displays Recorder ID and Recorder Screen Name. Displays Time and Date.
Clock	Accuracy: ± 20 ppm (± 1 minute/month) @ 25°C. Summer/Winter manual or automatic time adjustment or via communications. SNTP Client and/or Server included for synchronizing over Ethernet.
Alarm Set Points	6 per pen integral “soft” alarm set points easily set by user to announce selected out of limit conditions; user can select if an alarm triggers a change in the screen background colour. Alarm triggers can be set for Hi, Lo, Deviation (latched or unlatched) for alarm acknowledgement. Alarm Damping – 1 sec to 24 Hours; Hysteresis - +/- 100% of pen scale Common relay output: 1A 24V, can be activated on any alarm.
Data Replay Mode	Data replay facility on chart displays at normal, fast or slow speeds with zoom and cursor.
Display Chart Speeds	Chart rates: 1 mm/hour, 5 mm/hour, 10 mm/hour, 20 mm/hour, 30 mm/hour, 60 mm/hour, 120 mm/hour, 600 mm/hour, 1200 mm/hour, 6000 mm/hour. Combinations of rates can be mixed and chart speeds can be set independently for each chart. Display speeds are independent of logging rate
Messages Screen	The message screen displays system information and records any setup activity that has been changed. It also provides warning and error message updates, lists alarm activity and will display user defined marks on a chart.
CE Conformity (CE Mark) Immunity Product Classification Enclosure Rating Installation Requirements EMC Standards Safety	Complies with EN 61010-1:2010 Class I: Cord Connected, Panel Mounted Industrial Control Equipment with protective earthing (grounding). (EN 61010-1:2010) Front panel designed to NEMA Type 3 / IP55 (Optional NEMA Type 4X / IP66) Category II: Overvoltage (EN 61010-1: 2010) Pollution Degree 2 Cooling type: Natural air convection Indoor use only EMC Directive 2004/108/EC <ul style="list-style-type: none"> • Emissions: Class A – EN55011/CISPR11 • Immunity: Industrial Levels – IEC/EN 61326-1:2013 Complies with <ul style="list-style-type: none"> • CE LVD: 2006/95/EC - IEC/EN 61010-1 :2010 (3rd Edition) • CSA C22.2 No. 61010-1 (3rd Edition) • UL 61010-1 (3rd Edition) Panel Mounted Equipment, Terminals must be enclosed within the panel.

Specification	Design Attributes
Number of Inputs	4, 6, 8, 12 or 16 input channels
Input Types	mV, V, mA with external shunt (provided as standard), Thermocouple, RTD and ohms
Minimum Input Span	Range is fully configurable with span limitation of the operating range selected with 4% under range to 4% over-range capability (50V Range 2%)
Burnout (T/C)	Active (High or Low), Passive, and Health watch/Maintenance (option).
Cold Junction Compensation	Internal compensation with the ability to manually adjust values, External Input for compensation, External CJC value specified
Input Resolution	0.0015% (16 Bit ADC)
Input Impedance	Current loop resistance: 10 ohms, use $\pm 0.1\%$ external resistor. Volts $> 1M\Omega$, all other $10M\Omega$
Source Impedance	T/C and RTD: 100 ohms per lead maximum. (A single point cal on Slot A will improve accuracy for a lead resistance above 10 ohms).
Square Root Extraction	Available as standard on every input type
Sensor Compensation	Single point and Dual point
Recorder slots	Two slots available for a mix of analogue inputs, digital inputs, digital outputs, analogue outputs
Input Sampling Rate	The input sampling rate is dependent on actuation type. All Inputs: 100mS (10Hz), 200mS (5Hz), 500mS (2Hz) Fast Sampling: 20mS (50Hz) - mA, mV, Volts and Ohms only
Scales, Linear & Logarithmic	Normal and Scientific notation Decimal Point automatic or programmable Engineering units, user definable (10 characters) Logarithmic Decade limits: -38 min, to +38 max, (recommend up to 20 decades on one screen to ensure clarity)
Input Isolation	300VAC channel-to-channel, channel-to-ground
Noise Rejection (at 50/60Hz) +/-2%	Common mode: 2Hz = -120dB, 5Hz = -120dB, 10Hz = -120dB Normal Mode: 2Hz = -85dB, 5Hz = -80dB, 10Hz = -48dB

Specification	Logging
Logging Method	Sample, Average, Min/Max - can be set independently per pen
Logging Types	Continuous, Fuzzy
Logging Rate	From 20 msec. to 60 hours per pen
Fuzzy Logging	A secure data storage technique which delivers data compression ratio of 100:1 or more; self teaching, storing the data at a variable rate to match the process

Specifications	Physical Parameters
Enclosure/Bezel	High impact resistant engineering plastic bezel and case; Chromate finished Aluminum Chassis and scratch resistant touch panel. NEMA Type 3 / IP55 protection rating standard. Optional NEMA Type 4X / IP66 (Front face only)
Mounting Panel	Unlimited mounting angle. For the best view of the display the viewing angle should not exceed 55° from the left or right, 40° looking down and 50° looking up at the recorder display. Mounting adjustable for panel thickness of 2mm to 20mm. Adapter kits available for covering existing panel cutouts.
Dimensions	W: 380mm (14.97"), H: 387mm (15.23"), D: 130mm (5.14"). Depth behind panel – 76.2mm (3.0"). Cutout 323 x 323mm (12.7 x 12.7")
Weight	8 kg (17.5lb) max.
Colour	Bezel: Grey

Wiring Connections	IEC Power Plug. Removable terminal strip for input and alarm connections
---------------------------	--

Input Range Performance and Accuracy

Input Actuation (Linear)	Range		Accuracy		##Temp. Stability % F.S. +/-	Input Impedance	
Millivolts DC	-5 to 5, -10 to 10, -25 to 25, -50 to 50, -100 to 100, -250 to 250, -500 to 500, -1000 to 1000		+/- 0.2% F.S. +/- 0.1% F.S. +/- 0.1% F.S. +/- 0.1% F.S.		0.01%/ °C 0.01%/ °C 0.01%/ °C 0.01%/ °C	>10M ohms >10M ohms >10M ohms >10M ohms	
Volts DC	-0.3 to 0.3, -0.6 to 0.6, -1.5 to 1.5, -3 to 3, -6 to 6, -12 to 12, -25 to 25, -50 to 50		+/- 0.1% F.S. +/- 0.1% F.S. +/- 0.1% F.S.		0.01%/ °C 0.01%/ °C 0.01%/ °C	>1M ohms >1M ohms >1M ohms	
Milliamps **	4 to 20, 0 to 20		+/- 0.2% F.S.		0.01%/ °C		
Ohms, 200	0 to 200		+/- 0.1% F.S.		0.01%/ °C		
Ohms, 500	0 to 500		+/- 0.1% F.S.		0.01%/ °C		
Ohms, 1000	0 to 1000		+/- 0.1% F.S.		0.01%/ °C		
Ohms, 4000	0 to 4000		+/- 0.1% F.S.		0.01%/ °C		
Input Actuation (T/Cs)	Range		Ref. Accuracy		##Temp. Stability % F.S. +/-	#Field Cal Deg °F	#Field Cal Deg °C
	°F	°C	+/- °F	+/- °C			
B*	500 to 1000	260 to 538	8.1	4.5	0.01%/ °C	8.1	4.5
	1000 to 3300	538 to 1816	4.0	2.2			
E*	-454 to -328	-270 to -200	21.6	12	0.01%/ °C	21.6 3.1	12.00
	-328 to -94	-200 to -70	3.1	1.7			
	-94 to 1832	-70 to 1000	1.3	0.7			
J*	-346 to 32	-210 to 0	3.1	1.7	0.01%/ °C	0.8 0.63	0.44
	32 to 2192	0 to 1200	1.2	0.7			
K*	-454 to -94	-270 to -70	36 1.8	20	0.01%/ °C	36	20.00
	-94 to 2502	-70 to 1372		1			
R*	-58 to 500	-50 to 260	6.7	3.7	0.01%/ °C	6.7	3.7
	500 to 1202	260 to 650	2.7	1.5			
	1202 to 3214	650 to 1768	2.0	1.1			
S*	-58 to 500	-50 to 260	5.9	3.3	0.01%/ °C	5.9	3.3
	500 to 1832	260 to 1000	2.7	1.5			
	1832 to 3110	1000 to 1710	2.0	1.1			
	3110 to 3214	1710 to 1768	2.5	1.4			
T*	-454 to -346	-270 to -210	9.7	5.4	0.01%/ °C	9.7	5.4
	-346 to 752	-210 to 400	1.8	1			
L*	-328 to 32	-200 to 0	2.2	1.2	0.01%/ °C	1.0	0.56
	32 to 1652	0 to 900	1.3	0.7			
G* (W_W26)	32 to 212	0 to 100	45	25	0.01%/ °C	45 11.6	25
	212 to 600	100 to 316	11.2	6.2			
	600 to 1526	316 to 830	5.0	2.8			
	1526 to 2759	830 to 1515	3.1	1.7			
	2759 to 4199	1515 to 2315	5.0	2.8			

Input Actuation (T/Cs)	Range		Ref. Accuracy		##Temp. Stability % F.S.+/-	#Field Cal Deg °F	#Field Cal Deg °C		
	°F	°C	+/- °F	+/- °C					
C* (W5, W26)	32 to 356	0 to 180	4.5	2.5	0.01%/ °C	4.5	2.5		
	356 to 2228	180 to 1220	3.6	2				1.8 6.66	1.0
	2228 to 4199	1220 to 2315	6.7	3.7					
M* (NiMo-NiCo) (NNM90)	-58 to 698	-50 to 370	2.0	1.1	0.01%/ °C	1.0 0.72	0.56		
	698 to 2570	370 to 1410	1.4	0.8					
N* (Nicrosil Nisil)	-328 to 212	-200 to 100	5.8	3.2	0.01%/ °C	5.8	3.2		
	212 to 2372	100 to 1300	2.0	1.1				1.0	0.56
Chromel/Copel*	-58 to 1112	-50 to 600	1.1	0.6	0.01%/ °C	0.54	0.3		
P* (Platinel)	32 to 2534	0 to 1390	2.5	1.4	0.01%/ °C	1.4	0.78		
D*	32 to 356	0 to 180	6.3	3.5	0.01%/ °C	6.3	3.5		
	356 to 3344	180 to 1840	4	2.2				4	2.2
	3344 to 4515	1840 to 2490	11.7	6.5					

Input Actuation (Linear)	Range		Accuracy		##Temp. Stability % F.S. +/-	
PT100 $\alpha = 0.00385$	-328 to 1562	-200 to 850	1.1	0.6	0.01%/ °C	
PT200 $\alpha = 0.00385$	-328 to 1562	-200 to 850	1.1	0.6	0.01%/ °C	
PT500 $\alpha = 0.00385$	-328 to 1562	-200 to 850	1.1	0.6	0.01%/ °C	
PT1000 $\alpha = 0.00385$	-328 to 1562	-200 to 850	1.1	0.6	0.01%/ °C	
100 ohm Nickel	-76 to 356	-60 to 180	0.9	0.5	0.01%/ °C	
120 ohm Nickel	-112 to 500	-80 to 260	0.5	0.3	0.01%/ °C	
Cu10	-328 to 500	-200 to 260	5.5** *	3***	0.01%/ °C	
Cu53	32 to 302	0 to 150	0.5	0.3	0.01%/ °C	

Reference Temperature: 22°C

Reference Sample Rate: 2Hz (500msec)

Reference Humidity: 65% RH +/-15% Long term stability: 0.2%/year

* Does not includes reference junction calibration of ± 1.0 °C using the standard "ice bath" method of calibration. Factory accuracy can be improved by performing a field calibration. Also does not include any error on the sensor.

** Tolerance for these input types includes that of the external shunt resistors (0.1% tolerance)

*** Reference Accuracy can be improved to +/- 0.4°C/0.7°F using the single point compensation calibration

Not available on the eZtrend GR. Including all Field Cal values

Temperature Stability - Interpreted as % of Full Span per deg C change in ambient from Reference condition

Specification	Options
Pulse Input (optional)	4 isolated inputs per board, frequency – 1Hz to 25kHz, updated once per sec. Input: Low < 1V, High >4V to <50V or Volt free input: Low = short circuit, High = open circuit.
Alarm Outputs (optional)	Programmable alarm set points (6 per pen) can be configured to activate up to 16 outputs. Update rate: 200 ms for all alarms. Number/Type: <ul style="list-style-type: none"> • 4 or 8 relay contacts SPDT, 3A 240VAC, 3A 24VAC/DC, 0.2A 240VDC (non-inductive, internally suppressed) • 8 I/O or 16 I/O - SPNO 1A 24VDC (non-inductive, internally suppressed) Activation: Fully programmable internal alarm levels. Assignable to any relay output.
Digital Input/Output	8 I/O or 16 I/O: all channels may be selected freely as either digital inputs or outputs. The Digital I/O card also has 4 channels that can be set as pulse inputs (channels 1 to 4). The operating frequency for pulse inputs on the Digital I/O card is 1kHz max. 4 relay outputs: all four channels are relay outputs only. 8 relays/ 2 DI card: two outputs can be configured for use as digital inputs: A digital input is provided by a volt free contact between the normally open (NO), and the common (C), terminals of an output relay. If the 2 Digital inputs are used only 6 relay outputs are available. Closed <500 ohms, Open >300 kohms.
Analogue Outputs (Re-transmission Outputs) (optional)	2 or 4 re-transmission outputs available; a pen drives each output. Analogue inputs, totalised values or any mathematical result can be re-transmitted. Update Rate: 250 msec all channels Accuracy: $\pm 0.1\%$ 0-500 Ω load, $\pm 0.25\%$ 500 Ω 1K Ω load Type: 0 to 20 / 4 to 20 mA Maximum Load Resistance: 1000 Ohms Resolution: 0.002% Isolation: 300VAC
Transmitter Power (optional)	200mA @ 24VDC \pm 3VDC.
Miscellaneous	Optional customer ID Tagging (3 lines of up to 22 characters each line).
Firmware credit options	Maths (Basic, Full, Scripting), Events, Fast Scan, Totals, Custom Screens, Reports, Health Watch/Main-tenance, Printing, Batch, Counters, Modbus Master, Remote View, Email, Password Net Sync, AMS2750 Process, Secure Comms, Hardware Lock & Extra Pens. See Firmware Credit System on page 8.

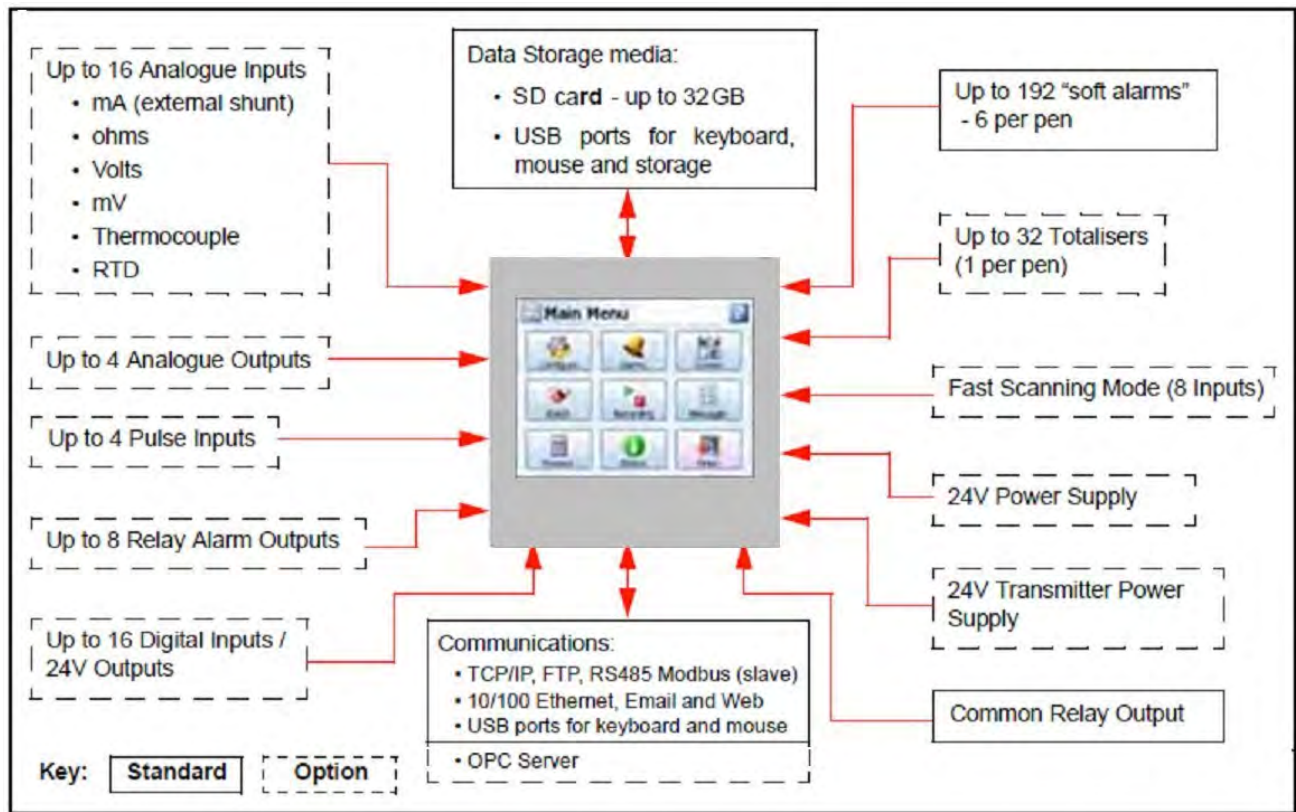

Connections

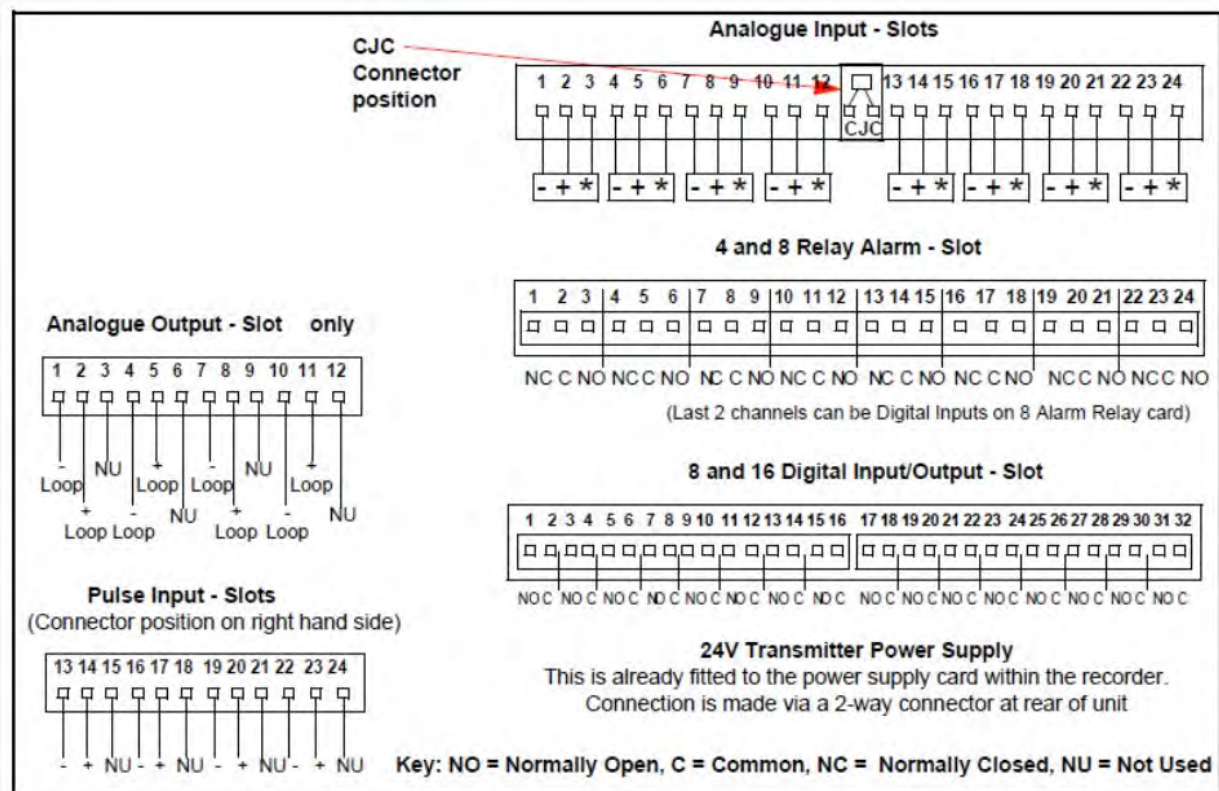

Installation

Reference Dimensions: $\frac{\text{millimeters}}{\text{inches}}$

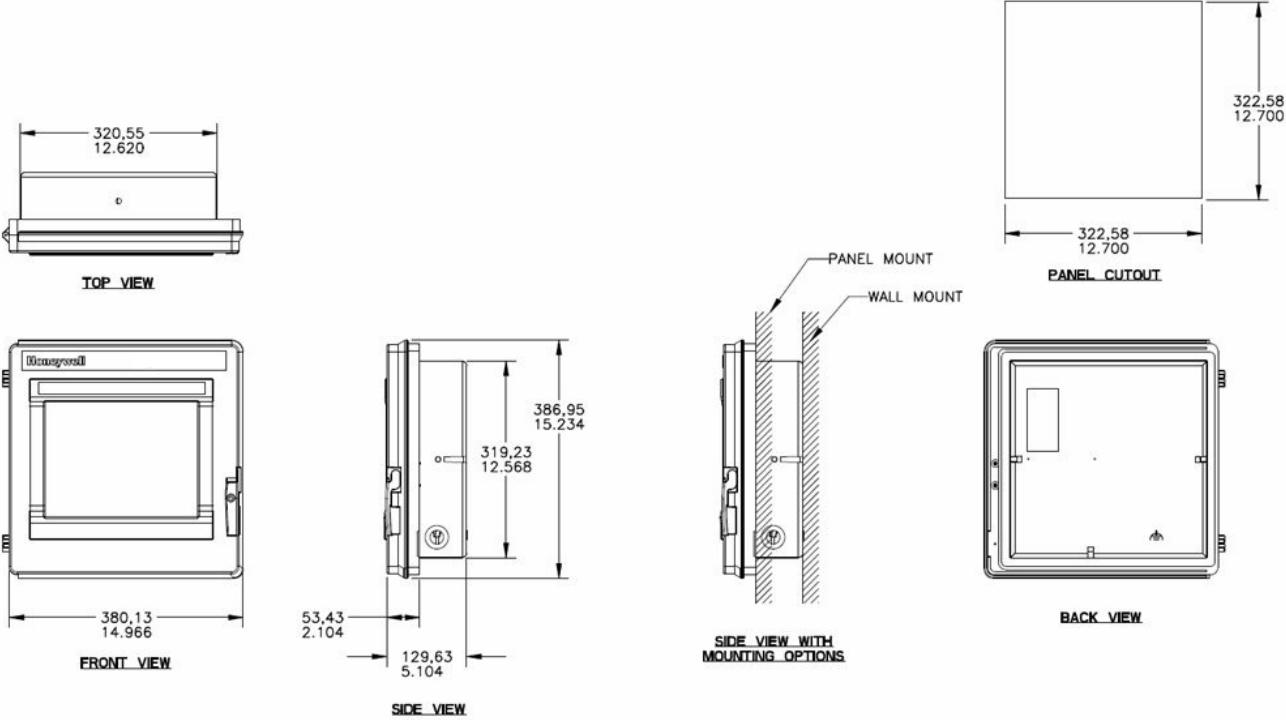

Dimensions are approximate.

Model Selection Guides are subject to change and are inserted into the specifications as guidance only. Prior to specifying or ordering a model check for the latest revision Model Selection Guides which are published at: www.honeywellprocess.com/paperless-recorders

Trendview DR Graphic Recorder

Model Selection Guide
43-TV-16-23 Issue 3



The DR Graphic recorder represents the latest in data acquisition and recording. Standard features include Ethernet communications, USB port, touch screen interface for easy configuration and navigation with a wide selection of optional features to handle most data acquisition applications.

Instructions

Make the desired selections from the Option Tables using the column below the proper arrow. A dot (•) denotes unrestricted availability. Restrictions follow Table VI.

Key Number I II III IV V VI
 [] - [] - [] - [] - [] - []

KEY NUMBER	Selection	Availability
DR Advanced Graphic Recorder with 12.1" Display	TVDRG2	↓

TABLE I - INPUTS/OUTPUTS (Notes 2 & 3)

Slot	Configuration	Note	Selection	Availability
Slot 1 (A0)	No Analog Inputs	(Note 1)	0 _ _	•
Slot 2 (A)	None		_ 0 _	•
	Four Analog Inputs	(Note 1)	_ 4 _	•
	Six Analog Inputs	(Note 1)	_ 6 _	•
	Eight Analog Inputs	(Note 1)	_ 8 _	•
	Four Pulse Inputs		_ P _	•
Slot 3 (B)	None		_ _ 0	•
	Six Additional Analog Inputs	(Note 1)	_ _ 6	f
	Eight Additional Analog Inputs	(Note 1)	_ _ 8	f
	Four Pulse Inputs		_ _ P	f
	8 Relay/2 Digital Inputs-6 Fixed Outputs/2 Configurable DI or Relay		_ _ 2	•
	8 Configurable Digital Inputs/Discrete 24V Relay Outputs		_ _ 3	•
	16 Configurable Digital Inputs/Discrete 24V Relay Outputs		_ _ 4	•
	Two Analog Outputs		_ _ A	•
Four Analog Outputs		_ _ B	•	

TABLE II - POWER

		Selection	Availability
Power	90 - 240 VAC Instrument Power	1 _	•
	90 - 240 VAC Instrument Power/ 24Vdc Transmitter Power	3 _	•
	24V DC Instrument Power	5 _	•
Input Frequency	50 Hz	_ 1	•
	60 Hz	_ 2	•

TABLE III - INTERNAL MEMORY FOR DISPLAY/DATA STORAGE

			Availability
Memory Card Expansion	1 Gb Internal Memory	0	•
	2Gb Internal Memory	1	•
	4Gb Internal Memory	2	•
	1 Gb Internal Memory + 8GB SD Card	3	•
	2Gb Internal Memory + 8GB SD Card	4	•
	4Gb Internal Memory + 8GB SD Card	5	•

TABLE IV - FIRMWARE CREDITS/OPTIONS

			Availability
Security / Firmware Credits	None	0 __	•
	ESS (Permanent Password Capability)	S __	•
	None	_ 0 _	•
	Five Credits	_ F _	•
	Ten Credits	_ 1 _	•
	Twenty Credits	_ 2 _	•
	Thirty Credits	_ 3 _	•
	Forty Credits	_ 4 _	•
	Fifty Credits	_ 5 _	•
	Sixty Credits	_ 6 _	•
Seventy Five Credits	_ 7 _	•	
Ninety-Nine Credits	_ 9 _	•	
Future	None	__ 0	•

CREDITS - Decide what functions are needed and select that many total "Credits" when ordering firmware options. For Example: If Math, Events and Totals are needed for the application, sum the values for each function listed below to determine the number of credits to purchase. Additional credits are available if needed using the Upgrade Procedure Credits can be selected/deselected and used interchangeably as long as the total credits purchased are not exceeded. Maximum number of credits available is 99 credits.

VALUE / FUNCTION	
2	Health/Maintenance
2	Print Function (USB) (Note 12)
2	Extra Pens (Note 6)
2	Config Lock Out
3	Remote Viewing
3	Reports
3	e-Mail

VALUE / FUNCTION	
3	Secure Comm (https)
3	Counters
4	Totals
4	Full Maths
4	Custom Screens (Note 13)
5	Fast Scan (Note 5)
5	Batch

VALUE / FUNCTION		
5	AMS2750 Process Mode	(Note 16)
5	Password Net Sync	
6	Events	(Note 11)
6	FF Math & Scripts	
10	Modbus Master	(Note 15)
10	AMS2750 TUS Mode	(Note 17)

TABLE V - OPTIONS

			Selection	Availability
Case/Mounting	Standard Panel Mounting	0 _____		•
Documentation Manuals (Note 14)	Product Information on CD with TrendViewer	_ 0 _____		•
	English Manual & Language Prompts with TrendViewer	_ U _____		•
	French Language Prompts Manual with TrendViewer	_ F _____		•
	German Language Prompts Manual with TrendViewer	_ G _____		•
Tagging	None	__ 0 ____		•
	Stainless Steel Tag (Note 7)	__ S ____		•
	1 Year Extended Warranty and GTS Support	__ 1 ____		•
	2 Year Extended Warranty and GTS Support	__ 2 ____		•
	1 Year Extended Warranty and GTS Support and SS Tag (Note 7)	__ T ____		•
2 Year Extended Warranty and GTS Support and SS Tag (Note 7)	__ U ____		•	
Standards	CE Mark/IP55/NEMA 3	___ 0 ___		•
	CE Mark/IP66/NEMA 4X	___ 1 ___		•
	CE Mark, UL Listed & CSA Approval/IP55/NEMA 3	___ 2 ___		•
	CE Mark, UL Listed & CSA Approval/IP66/NEMA 4X	___ 3 ___		•
Certificates	None	____ 0 _		•
	Certificate of conformance (F3391)	____ B _		•
	Custom Calibration test Report (F3399) (Note 8)	____ C _		•
	Certificate of Conformance & Calibration Test Report (Note 8)	____ E _		•
Software (Note 9)	None	____ 0		•
	Trend Manager Pro (Single User License)	____ P		•
	Trend Server Pro (Single User License)	____ S		•
	Trend Server Pro with OPC capability (Single User License)	____ T		•
	Screen Designer with Trendviewer	____ E		•
	Screen Designer with Trend Manager Pro (Single User License)	____ F		•
	Screen Designer with Trend Server Pro (Single User License)	____ G		•

TABLE VI

Factory Use Only	Standard Honeywell Version (Grey Bezel)	000	<input type="checkbox"/>	<input type="checkbox"/>
------------------	---	-----	--------------------------	--------------------------

RESTRICTIONS

Restriction Letter	Available Only With		Not Available With	
	Table	Selection	Table	Selection
f			I	_ 0 _

Notes:

1. Standard inputs include T/C, mV, V, Ma, Ohms and RTD actuations.
2. Relay Outputs are high level outputs (240VAC/3 Amp non-inductive loads).
3. Discrete Outputs are low level outputs (24VDC/1 Amp non-inductive loads).
Any channel on the 8 or 16 Discrete I/O Card can be used as a Digital Input if not used as an Alarm Output.
4. For 24V Instrument Power, the Input Filter Frequency Noise Rejection can be set for either 50 or 60 Hz
5. Fast Scanning only applies when an input is configured as linear (mV, V, Ma) inputs.
6. Extra Pens can be used to write analog values to the recorder using the Ethernet Modbus protocol without needing the full complement of analog inputs. Using all the virtual pens with many complicated maths and other functions can affect the overall performance of the recorder. Maximum available extra pens are 48.
7. Customer must supply tagging information, Up to 3 lines of 22 characters each are allowed
8. Calibration Test Reports/Certificates require specific Range and Input Actuation data from the customer. Form F3399 Supplemental Data must be completed. This can be downloaded from www.Honeywellprocess.com
9. Software Packages can be ordered separately (see Accessories price page)
10. The 50/60 Hz setting can be changed in the recorder setup to match the local power conditions. It can be ordered set for either 50Hz or 60Hz. This setting should match the local powerline frequency to provide the best noise rejection.
11. The events currently include: Into, Out of and Alarm Ack, Start, Stop, Reset, Reset & Start Totals, Digital Input ON/OFF/State Change, T/C Burnout, Mark Chart, Start/Stop Logging, Digital Output ON/OFF, Scheduled - Once/Interval/Specific Days/Month End, User Counters, Reset Max/Mins, Emails, Screen Change, Print Screen, Counters - Reset/Increment, Chart Control-Pause/Stop/Resume/Clear/Prefill, Clear All Messages. System - Power ON, Setup Change, Internal Memory Low, Export Memory Low, FTP Memory Low, User Action - Mark Chart, Batch - Start/Stop/Pause, Delayed Event, Script Timers - Start/Stop/Reset/Reset & Start, Play Sound - Start/Stop, Display Alert, Reports, TUS - Start/Stop, AMS2750 Timer - TC Timers/Process Timers, Update Tabular Readings.
12. The Printer function can print screens from the Recorder to a PCL 3 type printer.
13. Custom Screen credits provide the ability to load custom screens into the recorder. Screen Designer Software is required for designing these custom screens at the PC. Circular chart format is a standard recorder screen not requiring Screen Designer.
14. The recorder supports local language prompts for the following languages: English, French, German, Italian, Spanish, Brazilian, Polish, Hungarian, Slovakian, Czech, Turkish, Romanian, Russian, Portuguese, Greek, Bulgarian Chinese, Japanese And Korean.
15. To write Modbus Slave values to the pens using Modbus Master requires Full Math or MathScripts to assign these values to a pen.
16. AMS2750 Process Mode credits allow the user to monitor T/C Usages, SAT Cal Due Date, TUS Due Date, Instrument Cal Due Date and Control T/C Due Date.
17. AMS2750 TUS Mode credits allow the recorder to do a temperature uniformity survey and create a data file that is used by the AMS2750 Report Generation Tool to generate a temperature uniformity survey report.

Sales and Service

For application assistance, current specifications, pricing, or name of the nearest Authorized Distributor, contact one of the offices below.

ASIA PACIFIC

Honeywell Process Solutions,
(TAC) hfs-tac-support@honeywell.com

Australia

Honeywell Limited
Phone: +(61) 7-3846 1255
FAX: +(61) 7-3840 6481
Toll Free 1300-36-39-36
Toll Free Fax:
1300-36-04-70

China – PRC - Shanghai

Honeywell China Inc.
Phone: (86-21) 5257-4568
Fax: (86-21) 6237-2826

Singapore

Honeywell Pte Ltd.
Phone: +(65) 6580 3278
Fax: +(65) 6445-3033

South Korea

Honeywell Korea Co Ltd
Phone: +(822) 799 6114
Fax: +(822) 792 9015

EMEA

Honeywell Process Solutions,
Phone: + 80012026455 or
+44 (0)1344 656000

Email: (Sales)

FP-Sales-Apps@Honeywell.com

or

(TAC)

hfs-tac-support@honeywell.com

AMERICA'S

Honeywell Process Solutions,
Phone: (TAC) 1-800-423-9883 or
215/641-3610
(Sales) 1-800-343-0228

Email: (Sales)

FP-Sales-Apps@Honeywell.com

or

(TAC)

hfs-tac-support@honeywell.com

Specifications are subject to change without notice.

TrendView is a registered trademark of Honeywell International Inc.

For more information

To learn more about TrendView Paperless
Recorders, visit www.honeywellprocess.com
Or contact your Honeywell Account Manager

Process Solutions Honeywell

1250 W Sam Houston Pkwy S
Houston, TX 77042

Honeywell Control Systems Ltd
Honeywell House, Skimped Hill Lane
Bracknell, England, RG12 1EB

Shanghai City Centre, 100 Jungi Road
Shanghai, China 20061

www.honeywellprocess.com



43-TV-03-19
June 2015

©2015 Honeywell International Inc.