

**DR4500A Truline Series  
HTST, STLR and  
Pasteurization Flow  
Circular Chart Flow  
Recorders**

**Model DR45AH – HTST (High Temperature Short Time)**

**Model DR45AS – STLR (Safety Thermal Limit Recorder)**

**Model DR45AP – Pasteurization (Flow)**

**Addendum**

**(to Product Manual  
44-45-25-30)**

**44-45-99-08  
10/05**



# Table of Contents

<b>SECTION 1 – INTRODUCTION.....</b>	<b>1</b>
1.1 Overview.....	1
1.2 Modifications.....	2
1.3 Pasteurization Functions.....	3
<b>SECTION 2– MODEL DR45AH - HTST (HIGH TEMPERATURE SHORT TIME).....</b>	<b>7</b>
2.1 Overview.....	7
2.2 Field Wiring.....	8
2.3 Connection to System.....	9
2.4 .ii.Configuration.....	14
2.5 .ii.HTST Operation.....	18
<b>SECTION 3– MODEL DR45AS - STLR (SAFETY THERMAL LIMIT RECORDER) .....</b>	<b>23</b>
3.1 Overview.....	23
3.2 Field Wiring.....	24
3.3 Connection to System.....	25
3.4 .ii.Configuration.....	30
3.5 .ii.HTST Operation.....	34
<b>SECTION 4– .II.MODEL DR45AP - PASTEURIZATION (FLOW).....</b>	<b>39</b>
4.1 Overview.....	39
4.2 Field Wiring.....	40
4.3 Connection to System.....	42
4.4 .ii.Configuration.....	44
4.5 .ii.FLOW Operation.....	50
<b>SECTION 5 – .II.PARAMETER CONFIGURATION TABLES .....</b>	<b>55</b>
5.1 Parameter Selections.....	55
<b>SECTION 6 – TESTING PROCEDURES FOR .....</b>	<b>73</b>
6.1 Overview.....	73
6.2 Configuration Check or Reconfiguration.....	74
6.3 Calibration Test.....	80
6.4 Indicating Thermometers Temperature Accuracy – Test 1, PMO 2003.....	85
6.5 Recording Thermometers Temperature Accuracy – Test 2, PMO 2003.....	86
6.6 Recording Thermometers Time Accuracy – Test 3, PMO 2003.....	88
6.7 Recording Thermometers Check Against Indicating Thermometers – Test 4, PMO 2003.....	89
6.8 Milk Flow Controls Milk Temperatures at Cut-in and Cut-out – Test 10, PMO 2003.....	90
6.9 Indicating Thermometers Thermometric Response – Test 7, PMO 2003.....	92
6.10 Recorder/Controller Thermometric Response – Test 8, PMO 2003.....	94
6.11 Locking and Sealing the Recorder.....	96
<b>SECTION 7 – .II.TESTS AND PROCEDURES FOR MODEL DR45AP -     PASTEURIZATION (FLOW).....</b>	<b>102</b>
7.1 Overview.....	102
7.2 Configuration Check or Reconfiguration.....	103
7.3 Magnetic Flowmeter Systems, Continuous Flow, Holding Time Test – Test 11, PMO 2003.....	108
7.4 Continuous Flow Holders – Flow Alarm Test – Test 11-2B, PMO 2003.....	112
7.5 Continuous Flow Holders – Loss-of-Signal Alarm Test – Test 11-2C, PMO 2003.....	114
7.6 Cut-in and Cut-out Flow Points Test – Test 11-2D, PMO 2003.....	116

7.7	Time Delay Relay Test – Test 11-2E, PMO 2003 .....	118
7.8	Differential Pressure Test – Test 9.4, PMO 2003.....	120
7.9	Locking and Sealing the Recorder.....	122
<b>SECTION 8 – HTST PARTS .....</b>		<b>128</b>

# Tables

---

Table 1-1	.ii.Pasteurization Selections .....	3
Table 1-2	Pasteurization Function Selection Procedure .....	6
Table 2-1	Setting Two Diversion Setpoints .....	11
Table 2-2	.ii.Input Versus Pen Assignments for Model DR45AH .....	15
Table 2-3	Configuration Procedure .....	16
Table 2-4	Future Changes.....	17
Table 3-1	Setting Two Diversion Setpoints .....	27
Table 3-2	.ii.Input Versus Pen Assignments for Model DR45AS .....	31
Table 3-3	Configuration Procedure .....	32
Table 3-4	Future Changes.....	33
Table 4-1	.ii.Input versus Pen Assignment Model DR45AP .....	45
Table 4-2	.iiDR45AP.Configuration Procedure.....	46
Table 4-3	Future Changes.....	49
Table 5-1	Configuration Prompts.....	55
<b>Tuning 1</b>	Group Function Prompts.....	55
<b>Tuning 2</b>	Group Function Prompts.....	56
<b>Chart</b>	Group Function Prompts.....	57
<b>Pen 1</b>	Group Function Prompts .....	58
<b>Pen 2</b>	Group Function Prompts .....	59
<b>Pen 3</b>	Group Function Prompts .....	60
<b>Pen 4</b>	Group Function Prompts .....	61
<b>Input 1</b>	Group Function Prompts .....	62
<b>Input 2</b>	Group Function Prompts .....	63
<b>Input 3</b>	Group Function Prompts .....	64
<b>Input 4</b>	Group Function Prompts .....	65
<b>Control 1</b>	Group Function Prompts .....	66
<b>Control 2</b>	Group Function Prompts .....	68
<b>Options</b>	Group Function Prompts .....	70
<b>Adjust Printing</b>	Group Function Prompts .....	71
Table 6-1	Automatic HTST or STLR Configuration .....	75
Table 6-2	Reconfiguration .....	76
Table 6-3	Calibration Test .....	81
Table 6-4	Calibration Test .....	83
Table 6-5	Temperature Accuracy Test for Indicating Thermometers.....	85
Table 6-6	Temperature Accuracy Test for Recording Thermometers .....	86
Table 6-7	Time Accuracy Test for Recording Thermometers .....	88
Table 6-8	Recording Thermometer Reading vs. Indicating Thermometer Reading Test .....	89
Table 6-9	Milk Temperatures at Cut-in and Cut-out Test.....	90
Table 6-10	Adjusting the Milk Diversion Setpoint Setting.....	91
Table 6-11	Thermometric Response Test for Indicating Thermometers .....	92
Table 6-12	Thermometric Response Test.....	95
Table 6-13	Setting the Lockout Switch .....	96
Table 6-14	Chart Configuration .....	98
Table 6-15	Pen Configuration.....	100
Table 6-16	Diversion Temperature Setpoints Check .....	101
Table 7-1	Automatic Flow Configuration .....	104
Table 7-2	Reconfiguration .....	105
Table 7-3	Continuous Flow, Holding Time Test .....	109
Table 7-4	Continuous Flow Holders, Flow Alarm Test.....	113
Table 7-5	Continuous Flow Holders, Loss-of-Signal Alarm Test .....	115
Table 7-6	Cut-in and Cut-out Flow Points Test .....	117
Table 7-7	Time Delay Relay Test.....	119
Table 7-8	Differential Pressure Test.....	121
Table 7-9	Setting the Lockout Switch .....	122
Table 7-10	Chart Configuration .....	124

Table 7-11 Pen Configuration ..... 125  
Table 7-12 Flow Diversion Setpoints Check..... 126

# Figures

---

Figure 1-1	DR45AH/DR45AP/DR45AS Recorders with Pasteurization Control .....	2
Figure 2-1	DR45AH Output Connections .....	8
Figure 2-2	Pasteurizer Control Box Connection Diagram .....	13
Figure 2-3	S1 Lockout Switch Location .....	14
Figure 2-4	Diagram of .ii.Milk Pasteurization Process.....	18
Figure 2-5	Simulated HTST Printed Chart.....	20
Figure 3-1	DR45AS Output Connections.....	24
Figure 3-2	Pasteurizer Control Box Connection Diagram .....	29
Figure 3-3	S1 Lockout Switch Location .....	30
Figure 3-4	Diagram of .ii.Milk Pasteurization Process.....	34
Figure 3-5	Simulated STLR Printed Chart.....	36
Figure 4-1	Output Connections.....	41
Figure 4-2	Pasteurizer Control Box Connection Diagram - Model DR45AP .....	43
Figure 4-3	S1 Lockout Switch Location .....	44
Figure 4-4	Diagram of Flow Milk Pasteurization Process.....	51
Figure 4-5	Simulated Flow Printed Chart.....	53
Figure 6-1	Communications Card Location .....	79
Figure 6-2	DR45AH/DR45AS Recorder with Pasteurization Control .....	97
Figure 7-1	Communications Card Location .....	107
Figure 7-2	DR45AH/DR45AP/DR45AS Recorder with Pasteurization Control.....	123





# Section 1 – Introduction

## 1.1 Overview

---

### Features

The DR45AH - HTST, DR45AP - FLOW, and DR45AS - STLR recorder/controllers combine the broad capabilities of the Truline recorders with the special features needed to serve the milk pasteurization requirements of the dairy industry.

These features address the need for sanitary protection as well as:

- accurate temperature measurement
  - precise control (temperature or flow)
  - comprehensive recording.
- 

### Milk Ordinance compliance

DR45AH - HTST, DR45AP - FLOW, and DR45AS - STLR recorder/controllers fully comply with the strict regulations of the “Grade A Pasteurized Milk Ordinance”.

Compliance features include:

- **Configuration Lockout switch**

This internal security switch limits access to configuration parameters. In the switch “off” position, you can configure all the recorder/controller parameters to the desired value.

The “on” position locks the majority of the configurable parameters, including hot milk diversion setpoint, so that they may not be changed.

The only functions remaining in the “on” (locked) position are:

*Chart* - start the chart or place it in hold.

*Man/Auto (HTST and FLOW only)*- You can place the hot water temperature controller (which controls the Milk temperature indirectly) in Manual or Automatic mode as defined below:

MAN - The output signal to the hot water valve is manually controlled.

AUTO - The setpoint for the hot water controller is adjustable.

*Lowr/Disp* - Lets you scroll through the process variable inputs, outputs, setpoints and deviation from setpoint.

*Configuration* - allows changes to Control 1 and Control 2(HTST and FLOW only) parameters plus adjustments to Time/Date/Day/Year.

- **Diversion Valve Position Indication**

Red and Green lights, visible through the door, indicate flow diversion valve position -

Red indicates flow diversion.

Green indicates forward flow.

- **Electronics Access Control**

Chart Plate sealing provisions, using a wire and lead seal, prevent undetected access to the electronics and configuration switch.

---

## 1.2 Modifications

### Component modification

Various modifications have been made to the DR4500A recorder for Pasteurization operation:

- Two clear, low profile indicator light lenses on the door
- Indicator light assembly - one red, one green light
- Captive screw and bracket
- Configuration Switch (Internal to unit on the Main processor board)
- Additional software supplied to accommodate pasteurization features

Figure 1-1 shows the location of the various hardware components.

Figure 1-1 DR45AH/DR45AP/DR45AS Recorders with Pasteurization Control

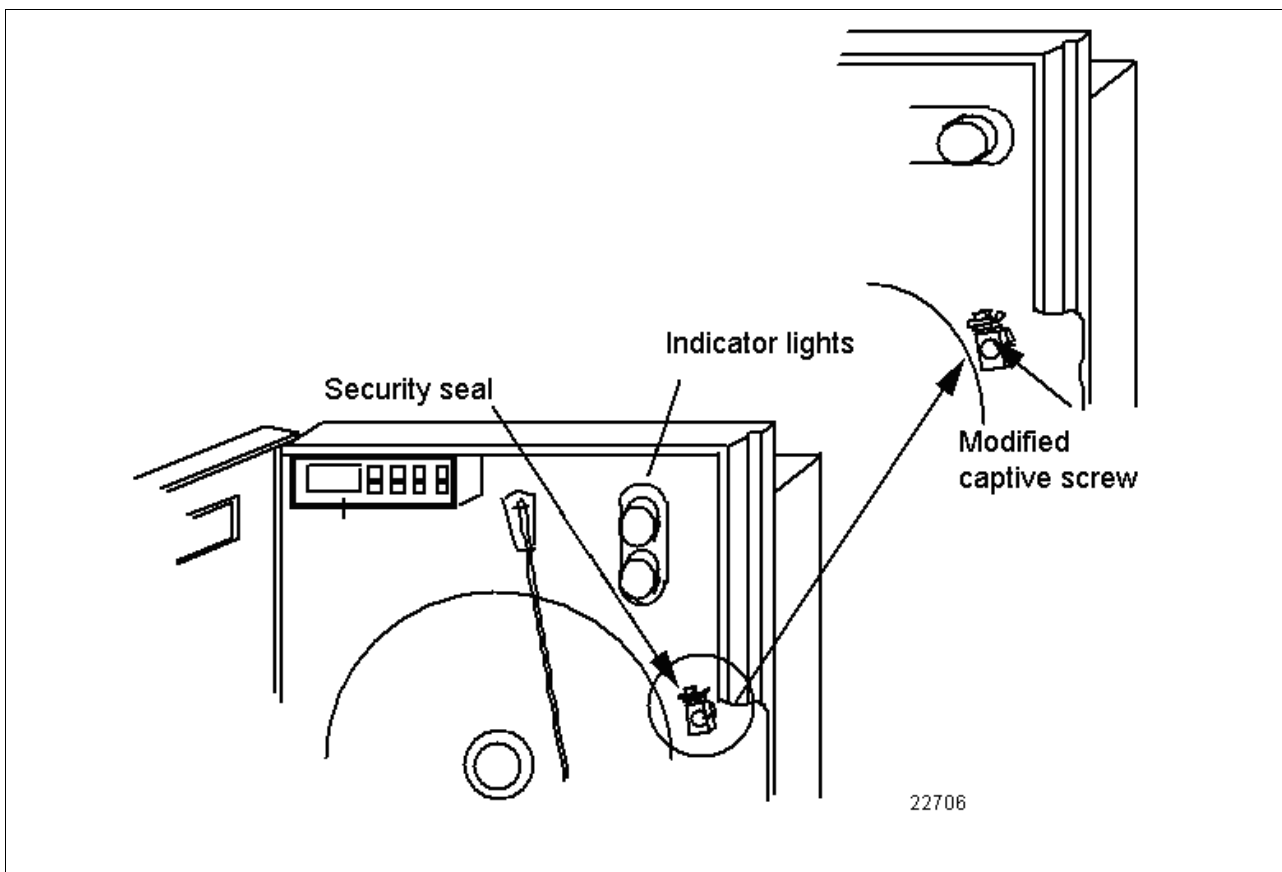

## 1.3 Pasteurization Functions

**PASTEUR selections** Under the “OPTIONS” Set Up group, there is a prompt labeled “PASTEUR”. The selections for this prompt are “NONE”, “HTST”, “STLR“, or FLOW”.

Table 1-1 gives a brief explanation of each selection.

Follow the procedure in Table 1-2 to select one of the pasteurization functions.

Table 1-1 Pasteurization Selections

Selection	How it works
<b>NONE</b>	The DR4500A behaves like a standard Truline except that the lockout switch is still functional in the same way it is on the HTST, STLR and FLOW selections (all configuration changes are locked out except for Control 1 and Control 2 tuning constants and time).
<b>HTST</b>	<ul style="list-style-type: none"> <li>• PID adjustments and Time/Date/Day/Year adjustments are allowed when the recorder is in the lockout mode.</li> <li>• A Digital Reference Thermometer can be enabled. In this mode, Input #1 is the Digital Reference and optional Input #3 (if enabled) will be used for PV1, the Hot Water Temperature. When the digital reference is disabled, Input #1 becomes PV1. The measured value of the reference (Input #1) will be the lower display default, while the upper display default will be the Hot Milk Temperature (Input 2). When the <b>lockout switch is closed</b>, the measured value of the reference (Input #1) will be the <i>only</i> value displayed in the lower display. The upper display default will be the Hot Milk temperature (Input #2). Pressing the <b>LOWR/DISP</b> key in this situation will show Input 1,2,3,4,SP1,SP2 successively in the upper display. The upper display default (Hot Milk) will return 30 seconds after the last press of the <b>LOWR/DISP</b> key.  When the <b>lockout switch is open</b>, the <b>LOWR/DISP</b> key functions normally and there are no default display timeouts. A digital Reference Alarm is available and adjustable from 0.5 to 5 deg.</li> <li>• When a divert condition occurs, and a reference thermometer is enabled, the value of the reference at the instant of diversion will be printed on the chart at the point where pen 3 shifts to indicate the diversion. When the forward condition is restored, the reference temperature at that point will also be printed on the chart where pen 3 shifts to indicate forward flow.</li> </ul>

*Table continued on next page*

## 1.3 Pasteurization Functions, Continued

### PASTEUR selections, continued

Table 1-1 Pasteurization Selections, continued

Selection	How it works
STLR	<ul style="list-style-type: none"> <li>• PID adjustments and Time/Date/Day/Year adjustments are allowed when the recorder is in the lockout mode.</li> <li>• A Digital Reference Thermometer can be enabled. In this mode, Input #2 is the Digital Reference            The measured value of the reference (Input #2) will be the lower display default, while the upper display default will be the Hot Milk Temperature (Input 1).            When the <b>lockout switch is closed</b>, the measured value of the reference (Input #2) will be the <i>only</i> value displayed in the lower display.            The upper display default will be the Hot Milk temperature (Input #1). Pressing the <span style="border: 1px solid black; padding: 0 2px;">LOWR/DISP</span> key in this situation will show Input 1,2,3,4,SP1,SP2 successively in the upper display. The upper display default (Hot Milk) will return 30 seconds after the last press of the <span style="border: 1px solid black; padding: 0 2px;">LOWR/DISP</span> key.             When the <b>lockout switch is open</b>, the <span style="border: 1px solid black; padding: 0 2px;">LOWR/DISP</span> key functions normally and there are no default display timeouts.</li> <li>• When a divert condition occurs, and a reference thermometer is enabled, the value of the reference at the instant of diversion will be printed on the chart at the point where pen 3 shifts to indicate the diversion.            When the forward condition is restored, the reference temperature at that point will also be printed on the chart where pen 3 shifts to indicate forward flow.</li> </ul>

*Continued on next page*

## 1.3 Pasteurization Functions, Continued

PASTEUR selections,  
continued

Table 1-1 Pasteurization Selections, continued









Selection	How it works
<b>FLOW</b>	<ul style="list-style-type: none"> <li>• The FLOW option allows a Hi and Lo flow setpoint to trigger a divert condition. Diversion occurs when the flow rate is below the Lo limit or above the High limit. The function prompts are HI FLOW and LO FLOW and appear after the “PASTEUR” prompt.</li> <li>• The FORWARD DELAY function sets a time period of from 0 to 60 seconds delay between when the flow value has reached a forward condition and when the relay actually switches to forward flow.</li> <li>• The HI and LO limits can be viewed in the bottom display and are indicated by “Flo” and “Fhi”.</li> <li>• The DIFFERENTIAL PRESSURE FUNCTION can be enabled if Input 2, Input 3, and Control 2 are enabled. It measures and displays the system high (pasteurized milk) and low (raw milk) pressures. Loop 2 setpoint will control to the differential (PV = IN2-IN3). The HI PRESSURE LIMIT function is used to deactivate Control #2, Relay #2 when the value of Input 2 (the high pressure side) exceeds the high limit. When the DP function is enabled, it is the default bottom display in the format DP XX - YY Where XX = HI Pressure (IN2) YY = LO Pressure (IN3) Pressing the <b>DISP</b> key successively yields: DIFF XX.X (Value of DP) DLim XX (DP Lo Limit) HLim XX (Hi Pressure Limit) Control #2, Relay 1 is deactivated if the differential pressure (DP) falls below the LO limit.</li> <li>• The DIFFERENTIAL PRESSURE LO LIMIT function is used for entering the value of the DP Lo limit.</li> <li>• The HP LIMIT function is used for entering the high pressure limit value.</li> <li>• The DP DELAY function is used for entering a value of from 0 to 60 seconds time delay between when the differential has reached a value greater than the limit and the relay activating.</li> </ul>

*Continued on next page*

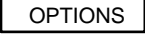
## 1.3 Pasteurization Functions, Continued

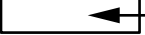
**Selection procedure** Follow the procedure in Table 1-2 to select a pasteurization function.

Table 1-2 Pasteurization Function Selection Procedure

Step	Operation	Press	Action/Result
1	Enter OPTIONS set up group		Until the displays read: Upper Display  Lower Display 
2	select PASTEUR prompt		Until the displays read: Upper Display  NONE Lower Display  HTST STLR FLOW
3	Select the desired type	 or 	<b>If you select:</b> <b>HTST</b> - Refer to Section 2 <b>STLR</b> - Refer to section 3 <b>FLOW</b> - Refer to Section 4

# Section 2– Model DR45AH - HTST (High Temperature Short Time)

## 2.1 Overview

### Introduction

In the HTST process, milk flows from the raw milk supply tank through the plate-type heat exchanger, where it is heated to pasteurization temperature prior to entering the holding tube.

The tube size ensures that the milk remains at the pasteurization temperature for the required time.

Hot milk temperature is measured as it leaves the holding tube. If this temperature is above the pasteurization temperature, the DR45AH HTST allows milk flow to proceed to packaging or storage. If the milk is below pasteurization temperature, the DR45AH HTST diverts it to the raw milk tank for reprocessing.

On the DR45AH recorder, the divert valve temperature is printed on the chart when Input 1 is programmed as a Digital Reference Temperature Indicator.

When a diversion occurs, the DR45AH recorder/controller will automatically print on the chart the temperature measured at the divert valve by the Digital Reference Thermometer and then, when forward flow is started again after the diversion, it will print the temperature again.

In addition, there are red and green indicator lights on the front of the recorder that provide a visual indication of forward flow (green) or flow diversion (red).

### What's in this section

This section contains the following information:

	Topic	See Page
2.1	Overview	7
2.2	Field Wiring	8
2.3	Connection to System	9
2.4	Configuration	14
2.5	Operation	18

### ATTENTION

After configuring the recorder, run the tests and perform the procedures listed in *Section 6- Tests and Procedures for Model DR45AH - HTST (High Temperature Short Time)*.

## 2.2 Field Wiring

**Simplified field wiring** Mount the recorder and wire the power and inputs as described in Product Manual 44-45-25-30.

Refer to Figures 2-1 and 2-2 for all other field wiring.

Note that additional software was added to change Loop 2-On/Off relay algorithm to use Loop 1 Control Board, thus eliminating the need for a second control board.

As shown in Figure 2-1, relay #1 on control board #1 (Plug J5) serves as the ON/OFF relay for the diverter valve.

Connect the leads from the SPST switch mounted on the flow diversion valve assembly to the Digital Input #1 (Plug J3 - Figure 2-1) through a latching relay (see Figure 2-2). Power is supplied to the contact from the recorder. The alarm relays, which have been connected to the indicator light assembly (Plug J4 - Figure 2-1), are then activated by the software depending on the state of this digital input.

**Output connections** Figure 2-1 is a diagram of the Output connections for the DR45AH Model.

Figure 2-1 DR45AH Output Connections

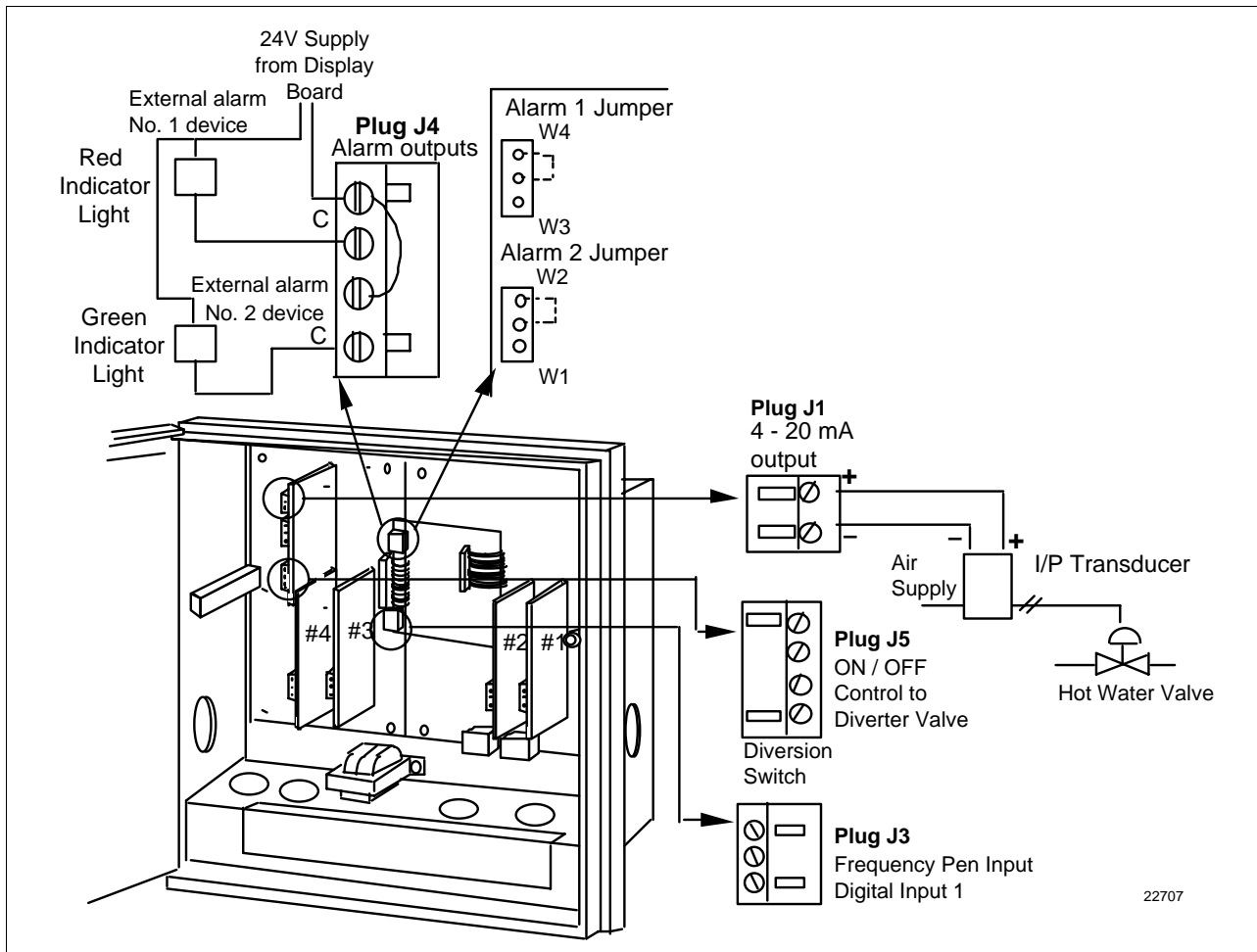



## 2.3 Connection to System

---

### Introduction

Two relays are required to interconnect the DR45AH recorder/controller to the HTST control system.

- Divert Relay Valve
- Diversion Switch Relay

Figure 2-2 shows this wiring.

The terminals in Figure 2-2 that are designated by a box □ are terminal numbers in the Pasteurizer Control Box. The designations are:

- 2 AC NEUTRAL
  - 3 AC HOT
  - 4 DIVERT
  - 5 LOW TEMPERATURE
  - 6 LEGAL
  - 7 FLOW FORWARD
- 

### Divert relay valve

The 115 Volt signal on the flow diversion valve switch is not acceptable as a digital input to the HTST unit. The digital input circuit in the HTST recorder/controller has its own power supply. Therefore, a latching relay, actuated by a switch on the flow diversion valve, will actuate the LR-IN coil providing a contact closure to the digital input and energizing the Green forward light and the frequency pen.

The latch-relay “out coil” is energized when the flow diversion valve and the leak detector valve both physically reach the diversion point. This opens the circuit to the digital input and actuates the Red diversion light and de-energizes the frequency pen.

---

### Diversion switch relay

The second loop ON/OFF control relay is used to actuate a DPDT relay to provide circuit interlocks to the timing pump and the solenoid valves to actuate the divert and leak detector valve. In the forward position, when the milk temperature is above pasteurization (control loop #2 setpoint), the two solenoid valves are actuated and the milk flows forward. When the milk temperature is sub-legal (below control loop #2 setpoint) the CR-1 relay is de-energized, the solenoid valves are de-energized, and the milk is diverted to the raw milk tank.

---

*Continued on next page*

## 2.3 Connection to System Continued

---

### Suitable relays

The model numbers for relays suitable for this application are given below. Other equivalent relays can be used.

#### **Divert Valve Latch Relay and Socket**

Struthers-Dunn B255BXPB and corresponding socket\*

120Vac, 2 coil latching relay: 2NO, 2NC contacts rated at 10 Amp

120Vac contacts remain in position on power failure until reset

Order screw terminal socket 27390 separately.

Base size 2-3/16" x 2-5/8"

*\* Use of a different manufacturer's relay socket can cause premature failure of the relay.*

#### **Diversion Switch Relay**

Potter Brumfield, DPDT

120Vac, 10 Amp, KRPA 11 AN120 - Coil - 2,250 ohms.

Octal Plug Termination Relay

Indicator light in parallel with coil

Order screw terminal socket #27E891

and hold down spring 20C176 separately

Base is 2.36" X 1.57"

**ATTENTION** The two relays must be mounted in an enclosure which has provisions for a Sanitarian's seal. This can be the existing wiring enclosure used for HTST.

---

*Continued on next page*

## 2.3 Connection to System, Continued

### Two diversion setpoints

Since the pasteurization process may include different products, two different setpoints can be assigned to control Loop 2 (pasteurization). A two deck switch is installed on the panel by the user. One set of contacts is wired to the second digital input of the HTST recorder/controller (see Figure 2-2). The second set of contacts is used to change the speed settings on the timing pump. Note that the Control 1 remote switch feature is not available because it is used as the diverter valve position indicator.

Configure the second setpoint as shown in Table 2-1.

Table 2-1 Setting Two Diversion Setpoints















Step	Operation	Press	Action/Result
1	Enter "Control 2" set up group		until the displays read: Upper Display  Lower Display 
2	Select Setpoint Source prompt		until the displays read: Upper Display  1 LOCAL Lower Display  REMOTE 2LOCAL COM SP
3	Select 2LOCAL	 or 	To select "2 LOCAL" which indicates two local setpoints.
4	Select Remote Switch Indication		until the displays read: Upper Display  NONE Lower Display  TO MAN TO LSP TO 2SP TO DIR RN/HLD
5	Select TO 2SP	 or 	To select "TO 2SP" which indicates the Remote Switch Diversion Setpoint will be switched to the local setpoint when the remote switch contact is closed.

Table continued on next page

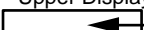
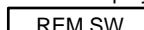
## 2.3 Connection to System, Continued

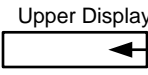
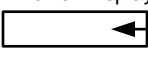
### Two diversion setpoints, continued

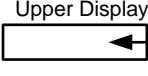
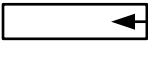
Table 2-1 Setting Two Diversion Setpoints, continued

Step	Operation	Press	Action/Result
6	Enter #1 Setpoint for Diversion	<b>LOWR DISP</b>	until you see: Upper Display  ← The PV value Lower Display  ← SP and the local setpoint value
		 or 	Enter #1 setpoint (for example:166°F)
7	Enter #2 Setpoint for Diversion	<b>LOWR DISP</b>	until you see: Upper Display  ← The PV value Lower Display  ← 2SP and the local setpoint value
		 or 	Enter #2 setpoint (for example:176°F)
8			Connect the remote switch to digital input plug J3 as shown in Figure 2-2.

*Continued on next page*

## 2.3 Connection to System, Continued

**Connection diagram** Figure 2-2 is the Pasteurizer Control Box connection diagram for Model DR45AH.

Figure 2-2 Pasteurizer Control Box Connection Diagram - Model DR45AH

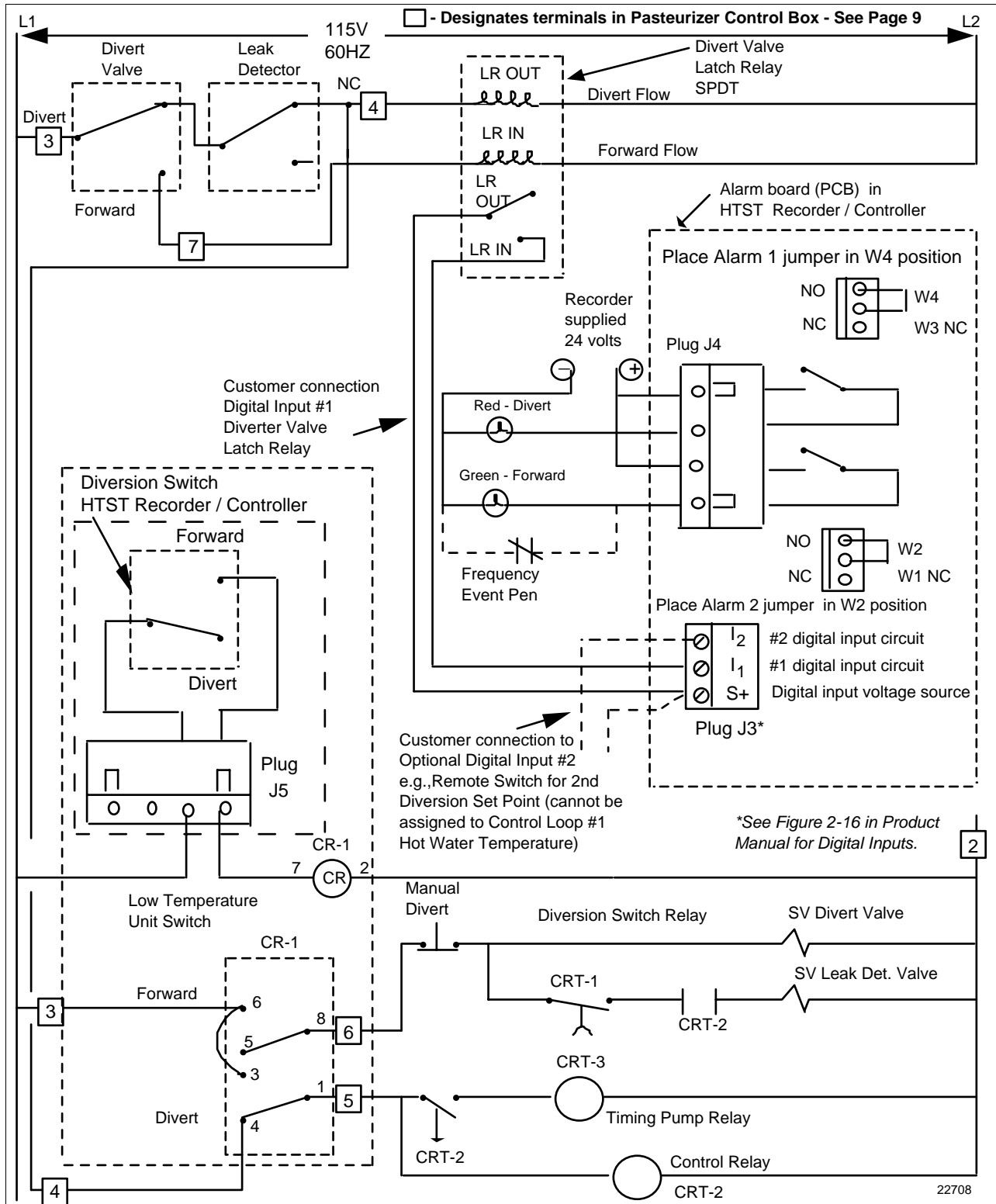

## 2.4 Configuration

### Restrictions based on Lockout switch position

Figure 2-3 shows the location of the S1 Lockout Switch on the Main Printed Circuit board.

When the Lockout switch is OFF (**Down** - Configure):

- You can view and change all applicable operating parameters as described in Section 4 of this Addendum.

When the Lockout switch is ON (**Up** - Locked):

- Most parameters for HTST Controller are locked and the parameters may not be changed except for Control 1 and Control 2 tuning parameters and adjustments to time/date/day/year.

Figure 2-3 S1 Lockout Switch Location

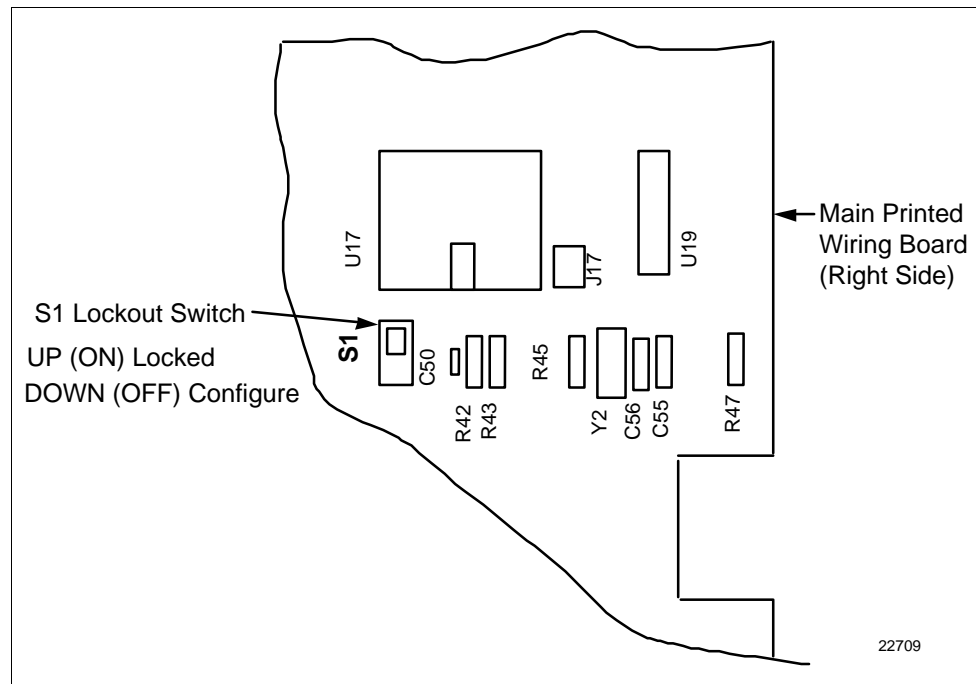

*Continued on next page*

## 2.4 Configuration, Continued

### Pens vs Inputs

The DR45AH Recorder/Controller can have up to 4 Analog Inputs and one Digital Input.

There are four pens to which these five inputs can be assigned. Some are required while others are optional. See Table 2-2.

Table 2-2 Input Versus Pen Assignments for Model DR45AH

INPUT	ASSIGNMENT	PEN
Analog Input #1	Hot Water or Digital Reference	Pen #1 (optional)
Analog Input #2	Hot Milk	Pen #2
Analog Input #3 (Optional)	Hot Water (when digital reference is selected for Input 1 and input 3 is enabled)	Pen #1 (optional)
	Cold Milk	Pen #4
Analog Input #4 (Optional)	Cold Milk or other temperature	Pen #4
Digital Input	Divert Valve Position	Pen #3

\* *The Digital Reference Temperature is displayed in the Lower Display.*

*Continued on next page*

## 2.4 Configuration, Continued

### Configuration procedure

Place the Lockout switch (S1) in the OFF (configure) position and follow the procedure in Table 2-3 to configure the DR45AH recorder/controller.

**ATTENTION** The prompting scrolls at a rate of 2/3 seconds when the **SET UP** or **FUNC** key is held in. Also, ▲ or ▼ keys will move group prompts forward or backward at a rate twice as fast.

Table 2-3 Configuration Procedure

Step	Operation	Press	Result
1	Set "LOCKOUT"	<b>SET UP</b>	until you see: Upper Display <b>SET UP</b> Lower Display <b>LOCKOUT</b>
2	Select "NONE" or "CALIB"	<b>FUNC</b>	until you see: Upper Display [ ] ← NONE CALIB Lower Display <b>LOCKOUT</b> +CONF +VIEW MAX Press the ▲ or ▼ keys to select None or Calib.
3	Select "OPTIONS" Set Up mode	<b>SET UP</b>	until you see: Upper Display <b>SET UP</b> Lower Display <b>OPTIONS</b>
4	Select HTST	<b>FUNC</b>	until you see: Upper Display [ ] ← NONE HTST Lower Display <b>PASTEUR</b> STLR FLOW Press the ▲ or ▼ keys to select HTST. <b>(Default HTST configuration is loaded when the <b>FUNC</b> key is pressed. Refer to Section 5)</b>
5	Select Reference Temperature Input (Optional)	<b>FUNC</b>	until you see: Upper Display [ ] ← DISABL ENABLE Lower Display <b>REF TEMP</b> Press the ▲ or ▼ keys to select ENABLE.
6	Set Digital Reference Alarm Value (only appears if reference temperature is enabled)	<b>FUNC</b>	until you see: Upper Display [ ] ← Value Range Lower Display <b>REF ALRM</b> 0.5 to 5 Press the ▲ or ▼ keys to set value.



## 2.4 Configuration, Continued

### Setting the lockout switch to LOCK

---

After all the parameters are configured, refer to **Section 5 - Tests and Procedures for Model DR45AH - HTST (High Temperature Short Time) or Model DR45AS - STLR (Safety Thermal Limit Recorder)**.

---

### Future changes in configuration parameters

After the Lockout Switch is placed in the ON (locked) position, the configuration parameters for Milk Diversion Valve control are “locked” (see “Restrictions”). If the Lockout switch is then sealed in the ON position, the configuration parameters may not be changed without first breaking the seal and then switching the Lockout switch to the OFF position.

To make configuration changes at some future time, follow the procedure in Table 2-4.

Table 2-4 Future Changes

Step	Action
1	Remove the security seal from the chart plate captive screw.
2	Open the chart plate and place the switch (S1) on the Main processor board in the OFF position.
3	Reconfigure the system and refer to <i>Section 6- Tests and Procedures for Model DR45AH - HTST (High Temperature Short Time) or Model DR45AS - STLR (Safety Thermal Limit Recorder)</i>
4	Place the switch (S1) on the Main processor board in the ON position, close the chart plate and add a security seal through the chart plate captive screw.

---

## 2.5 Operation

**HTST**  
(high temperature short time)

Figure 2-4 is a flow diagram of the milk pasteurization process. In the HTST process, milk flows from the raw milk supply tank through the plate-type heat exchanger, where it is heated to pasteurization temperature prior to entering the holding tube.

The tube size ensures that the milk remains at the pasteurization temperature for the required time.

Hot milk temperature is measured as it leaves the holding tube. If this temperature is above the pasteurization temperature, the DR45AH HTST allows milk flow to proceed to packaging or storage. If the milk is below pasteurization temperature, the DR45AH HTST diverts it to the raw milk tank for reprocessing.

For this application, DR45AH HTST uses two analog inputs, one digital input, one 3-mode controller and one on-off controller to control:

- Hot water flow to the plate heat exchanger
- Flow diversion valve position.

Figure 2-4 Diagram of Milk Pasteurization Process

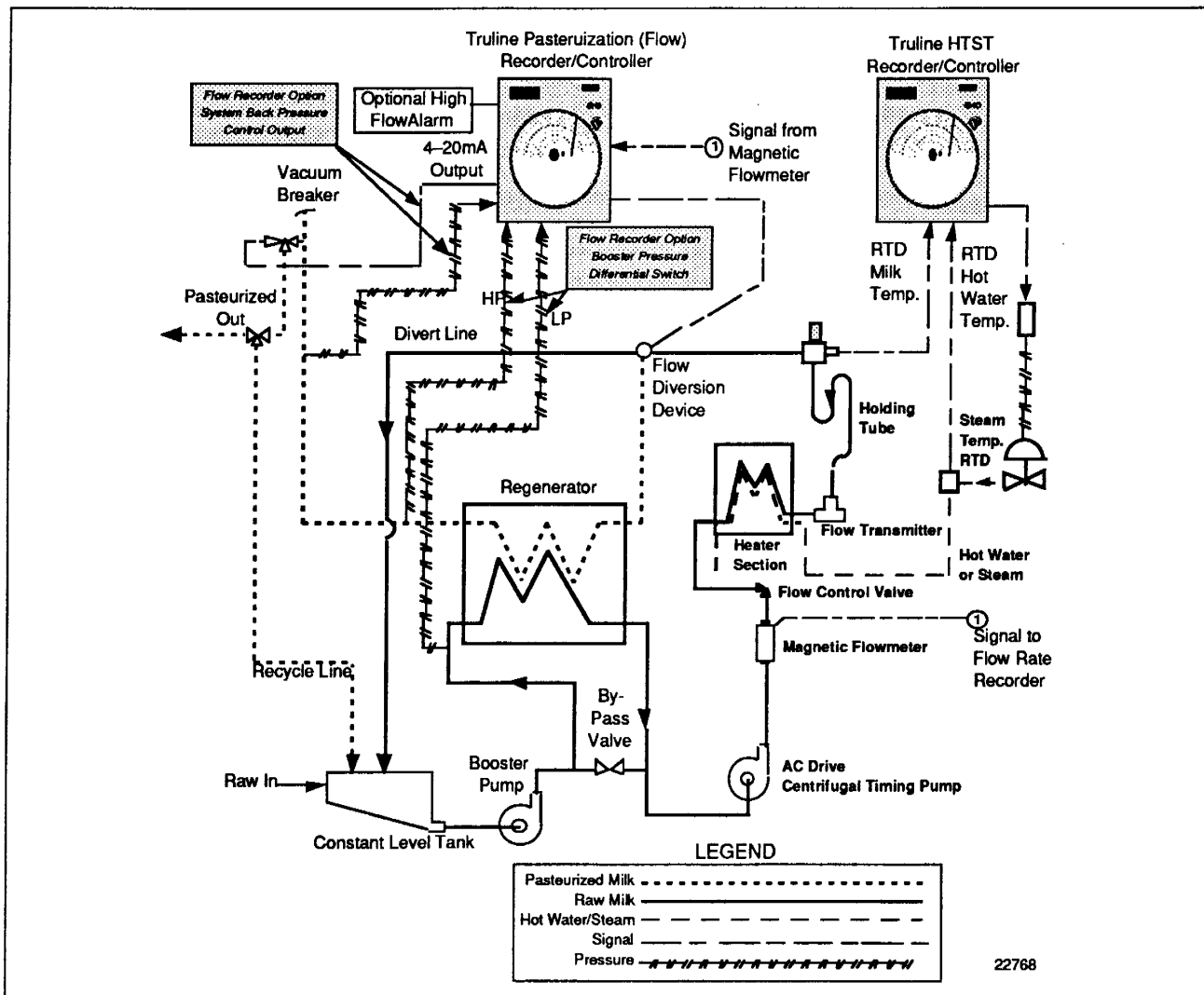

*Continued on next page*

## 2.5 Operation, Continued

### HTST (high temperature short time), continued

---

Pasteurization control consists of recording the information shown on the circular chart (Figure 2-5) and implementing the following strategies:

1. The first analog input is hot water temperature which indirectly controls milk temperature in the plate heat exchanger unless the Digital Reference Temperature is selected and then Input 1 is the digital reference and optional Input 3 (if enabled) becomes the Hot Water temperature input. This temperature is set as a default value to be recorded, but is not a requirement.
2. The hot milk temperature is the second analog input (default display on power up) This temperature is recorded. The high-precision, fast response RTD sensor provides this temperature measurement. DR45AH HTST uses 100-ohm ( $\alpha = 0.00385$ ) platinum bulb actuation to provide hot milk temperature measurement accuracy of  $\pm 0.3^{\circ}\text{F}$ .
3. A switch on the flow diversion valve provides the digital input to activate the frequency pen that records the valve position on the outer portion of the chart. The user supplies and installs the two relays that connect the recorder/controller to the pasteurizer system wiring.
4. When using inputs programmed as a digital reference measurement, the required RTD is a Fast Temperature response, Duplex RTD element, such as Model #21345(SP)-6-E-T11/2-2), available from RdF Corporation.

You can also record the flow diversion temperature setpoint without an additional analog input.

---

*Continued on next page*

## 2.5 Operation Continued

HTST (high temperature short time), continued

Figure 2-5 Simulated HTST Printed Chart

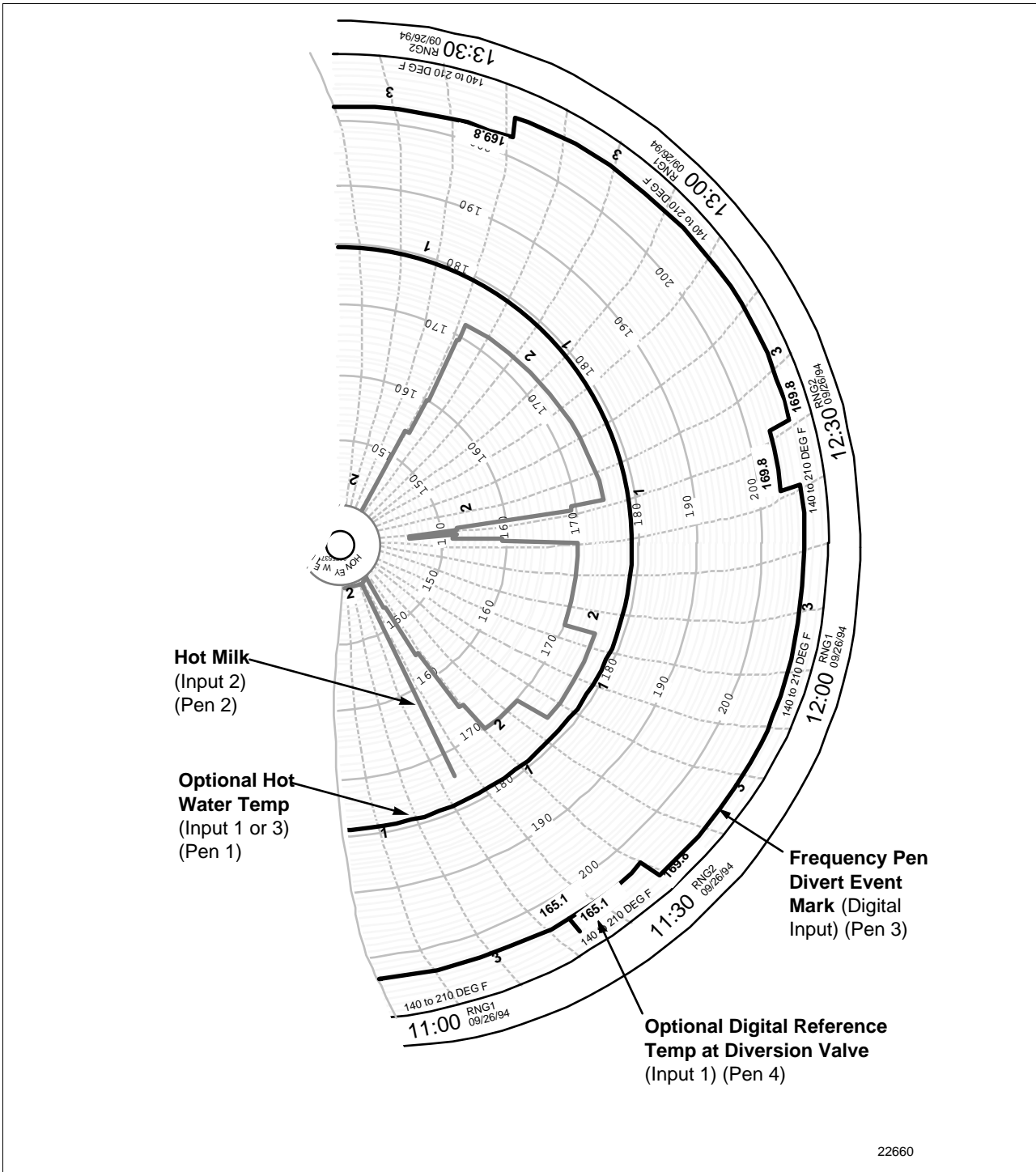

Continued on next page

## 2.5 Operation, Continued

---

### Flow diversion indication

On the DR45AH recorder, there is Flow Diversion Indication when Input 1 is programmed as a Digital Reference Temperature Indicator.

When a diversion occurs, the DR45AH recorder/controller will automatically print on the chart, the temperature measured at the divert valve and then, when forward flow is resumed after the diversion, it will print the temperature again.

In addition, there are red and green indicator lights on the front of the recorder/controller that provide a visual indication of forward flow or flow diversion.

---

### Digital reference temperature display

The Digital Reference Temperature is displayed in the lower display on the recorder. It cannot be changed as long as the lockout switch is on. Pressing the lower display key will display other parameters in the upper display (IN1, IN2, IN3, IN4, SP1, SP2). The default hot milk temperature will return to the upper display 30 seconds after the last key press.

The Digital Reference Temperature will go blank if the recorder detects an input fault.

Because the hot milk input and the digital reference input each have an accuracy of  $\pm 0.3^{\circ}\text{F}$ , it is possible to have a difference of up to  $0.6^{\circ}\text{F}$  between the two. This difference can be eliminated by using the Input Compensation function in the Input 1/Input 2 (1 = Digital Reference Temperature, 2 = Hot Milk) Set up Groups.

The “INPTCOMP” function prompt under Set up groups “INPUT 1” and “INPUT 2” adds/subtracts a Bias from the input value to compensate for small inaccuracies in the input. By using this feature, both inputs can be made equal. This compensation, if necessary, should be done before the sanitarian’s seal is applied.

*(Refer to Subsection 3.11 in the Product Manual for bias adjustment information.)*

---

### Digital reference alarm

A Digital Reference Alarm can be set to become active if the absolute difference between the value of the digital reference and the hot milk temperature exceeds the configured limit.

The limit is adjustable from 0.5 to 5 degrees. Refer to subsection 5.1 - Set up group “Options”, function prompt “REF ALRM”.

---

*Continued on next page*

## 2.5 Operation, Continued

---

### Speed of response test

The digital display for the Hot Milk temperature (default display on power up) must be used when doing the speed of response test as specified by the Grade A Pasteurized Milk Ordinance, U.S. Department of Health and Human Services.

If the Digital Reference Thermometer is enabled, the Hot Milk temperature is the default value in the upper display and the temperature of the Digital Reference Thermometer at the divert valve is in the lower display; otherwise, press the **LOWR DISP** key until "IN2 XXX" appears in the lower display to show the Hot Milk Temperature.

The Truline recorder uses a dot fill technique from a microprocessor algorithm to produce a continuous analog trace of a process variable. Every six seconds the recorder arm makes a pass across the chart paper and prints the record.

However, the digital display and the inputs to the recorder are updated three times per second with two inputs or  $2/3$  seconds with more than two inputs.

In addition, the milk temperature input, used for operating the diversion valve, is updated three times per second or three times every two seconds if more than 2 inputs are enabled.

Therefore, the response time for diversion on low temperature is not dependent on the record on the chart.

Also, if input filtering is used, it may affect the results of the speed of response test.

---

# Section 3– Model DR45AS - STLR (Safety Thermal Limit Recorder)

## 3.1 Overview

### Introduction

In the Pasteurization process, milk flows from the raw milk supply tank through the plate-type heat exchanger, where it is heated to pasteurization temperature prior to entering the holding tube.

The tube size ensures that the milk remains at the pasteurization temperature for the required time.

Hot milk temperature is measured as it leaves the holding tube. If this temperature is above the pasteurization temperature, the DR45AS STLR allows milk flow to proceed to packaging or storage. If the milk is below pasteurization temperature, the DR45AS STLR diverts it to the raw milk tank for reprocessing.

On the recorder, the divert valve temperature is printed on the chart when Input 2 is programmed as a Digital Reference Temperature Indicator.

When a diversion occurs, the DR45AS recorder will automatically print on the chart the temperature measured at the divert valve by the Digital Reference Thermometer and then, when forward flow is started again after the diversion, it will print the temperature again.

In addition, there are red and green indicator lights on the front of the recorder that provide a visual indication of forward flow (green) or flow diversion (red).

### What's in this section

This section contains the following information:

	Topic	See Page
3.1	Overview	23
3.2	Field Wiring	24
3.3	Connection to System	25
3.4	Configuration	30
3.5	Operation	34

### ATTENTION

After configuring the recorder, run the tests and perform the procedures listed in *Section 6- Tests and Procedures for Model DR45AH - HTST (High Temperature Short Time) or Model DR45AS - STLR (Safety Thermal Limit Recorder)*





## 3.3 Connection to System

---

### Introduction

Two relays are required to interconnect the DR45AS recorder to the STLR system.

- Divert Relay Valve
- Diversion Switch Relay

Figure 3-2 shows this wiring.

The terminals in Figure 3-2 that are designated by a box □ are terminal numbers in the Pasteurizer Control Box. The designations are:

- 2 AC NEUTRAL
  - 3 AC HOT
  - 4 DIVERT
  - 5 LOW TEMPERATURE
  - 6 LEGAL
  - 7 FLOW FORWARD
- 

### Divert relay valve

The 115 Volt signal on the flow diversion valve switch is not acceptable as a digital input to the STLR unit. The digital input circuit in the STLR recorder has its own power supply. Therefore, a latching relay, actuated by a switch on the flow diversion valve, will actuate the LR-IN coil providing a contact closure to the digital input and energizing the Green forward light and the frequency pen.

The latch-relay “out coil” is energized when the flow diversion valve and the leak detector valve both physically reach the diversion point. This opens the circuit to the digital input and actuates the Red diversion light and de-energizes the frequency pen.

---

### Diversion switch relay

The first loop ON/OFF control relay is used to actuate a DPDT relay to provide circuit interlocks to the timing pump and the solenoid valves to actuate the divert and leak detector valve. In the forward position, when the milk temperature is above pasteurization setpoint, the two solenoid valves are actuated and the milk flows forward. When the milk temperature is sub-legal (below setpoint) the CR-1 relay is de-energized, the solenoid valves are de-energized, and the milk is diverted to the raw milk tank.

---

*Continued on next page*

### 3.3 Connection to System Continued

---

#### Suitable relays

The model numbers for relays suitable for this application are given below. Other equivalent relays can be used.

#### **Divert Valve Latch Relay and Socket**

Struthers-Dunn B255BXP and corresponding socket\*

120Vac, 2 coil latching relay: 2NO, 2NC contacts rated at 10 Amp

120Vac contacts remain in position on power failure until reset

Order screw terminal socket 27390 separately.

Base size 2-3/16" x 2-5/8

*\* Use of a different manufacturer's relay socket can cause premature failure of the relay.*

#### **Diversion Switch Relay**

Potter Brumfield, DPDT

120Vac, 10 Amp, KRPA 11 AN120 - Coil - 2,250 ohms.

Octal Plug Termination Relay

Indicator light in parallel with coil

Order screw terminal socket #27E891

and hold down spring 20C176 separately

Base is 2.36" X 1.57"

**ATTENTION** The two relays must be mounted in an enclosure which has provisions for a Sanitarian's seal. This can be the existing wiring enclosure used for STLR.

---

*Continued on next page*

### 3.3 Connection to System, Continued

#### Two diversion setpoints

Since the pasteurization process may include different products, two different setpoints can be assigned to control Loop 1 (pasteurization). A two deck switch is installed on the panel by the user. One set of contacts is wired to the first digital input of the STLR recorder (see Figure 3-2). The second set of contacts is used to change the speed settings on the timing pump. Note that the Control 2 remote switch feature is not available because it is used as the diverter valve position indicator. Configure the second setpoint as shown in Table 3-1.

Table 3-1 Setting Two Diversion Setpoints













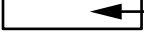

Step	Operation	Press	Action/Result
1	Enter "Control 1" set up group		until the displays read: Upper Display  Lower Display 
2	Select Setpoint Source prompt		until the displays read: Upper Display  1 LOCAL Lower Display  REMOTE 2LOCAL COM SP
3	Select 2LOCAL	 or 	To select "2 LOCAL" which indicates two local setpoints.
4	Select Remote Switch Indication		until the displays read: Upper Display  NONE Lower Display  TO MAN TO LSP TO 2SP TO DIR RN/HLD
5	Select TO 2SP	 or 	To select "TO 2SP" which indicates the Remote Switch Diversion Setpoint will be switched to the local setpoint when the remote switch contact is closed.

Table continued on next page

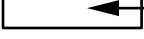
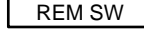
### 3.3 Connection to System, Continued

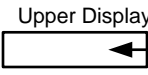
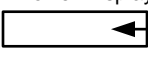
#### Two diversion setpoints, continued

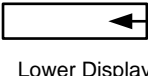
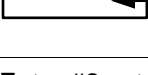
Table 3-1 Setting Two Diversion Setpoints, continued

Step	Operation	Press	Action/Result
6	Enter #1 Setpoint for Diversion	<b>LOWR DISP</b>	until you see: Upper Display  ← The PV value Lower Display  ← SP and the local setpoint value
		 or 	Enter #1 setpoint (for example:166°F)
7	Enter #2 Setpoint for Diversion	<b>LOWR DISP</b>	until you see: Upper Display  ← The PV value Lower Display  ← 2SP and the local setpoint value
		 or 	Enter #2 setpoint (for example:176°F)
8			Connect the remote switch to digital input plug J3 as shown in Figure 3-2.

*Continued on next page*

### 3.3 Connection to System, Continued

**Connection diagram** Figure 3-2 is the Pasteurizer Control Box connection diagram for Model DR45AS.

Figure 3-2 Pasteurizer Control Box Connection Diagram - Model DR45AS

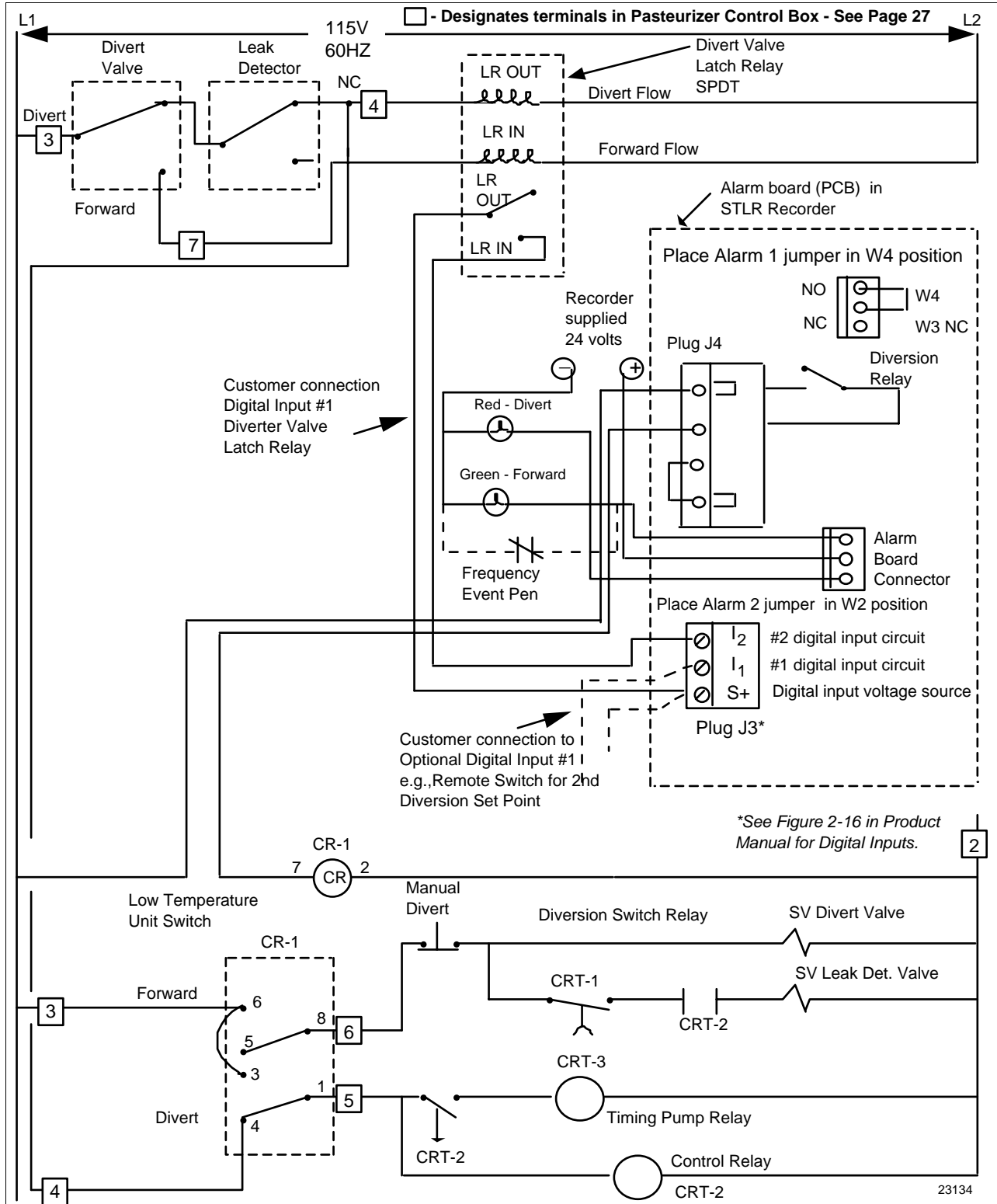

## 3.4 Configuration

### Restrictions based on Lockout switch position

Figure 3-3 shows the location of the S1 Lockout Switch on the Main Printed Circuit board.

When the Lockout switch is OFF (**Down** - Configure):

- You can view and change all applicable operating parameters as described in Section 5 of this Addendum.

When the Lockout switch is ON (**Up** - Locked):

- Most parameters for the STLR are locked and the parameters may not be changed except for adjustments to time/date/day/year.

Figure 3-3 S1 Lockout Switch Location

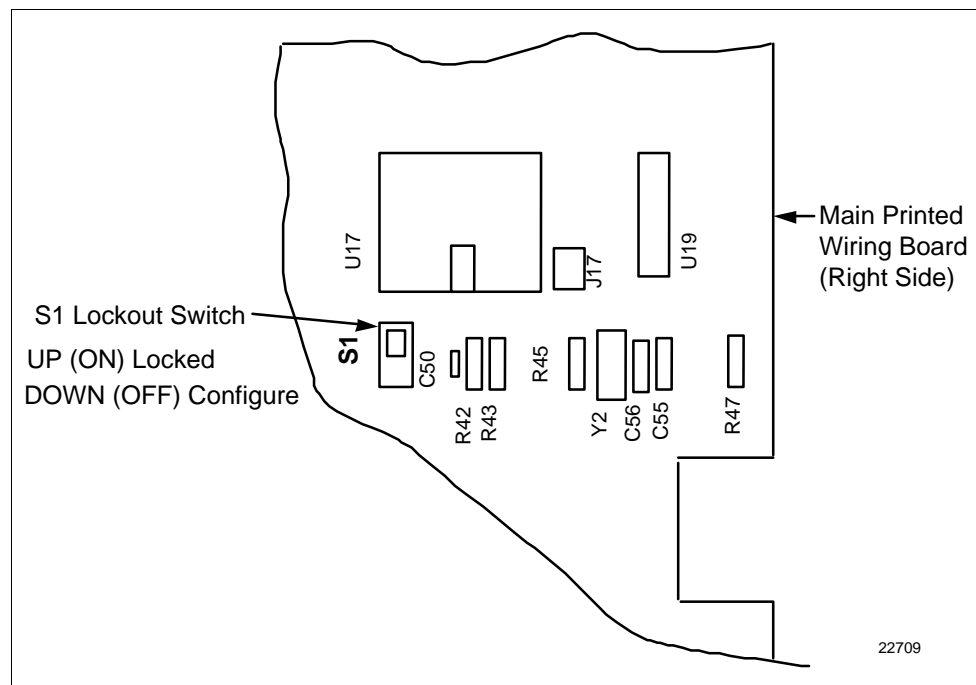

*Continued on next page*

### 3.4 Configuration, Continued

#### Pens vs Inputs

The DR45AS Recorder can have up to 4 Analog Inputs and one Digital Input.

There are four pens to which these five inputs can be assigned. Some are required while others are optional. See Table 3-2.

Table 3-2 Input Versus Pen Assignments for Model DR45AS

INPUT	ASSIGNMENT	PEN
Analog Input #1	Hot Milk	Pen #1
Analog Input #2 (optional)	Digital Reference	Pen #2
Analog Input #3 (Optional)	Cold Milk	Pen #4
Analog Input #4 (Optional)	Cold Milk or other temperature	Pen #4
Digital Input	Divert Valve Position	Pen #3

\* *The Digital Reference Temperature is displayed in the Lower Display.*

*Continued on next page*

### 3.4 Configuration, Continued

**Configuration procedure**

Place the Lockout switch (S1) in the OFF (configure) position and follow the procedure in Table 3-3 to configure the DR45AS recorder.

**ATTENTION** The prompting scrolls at a rate of 2/3 seconds when the **SET UP** or **FUNC** key is held in. Also, ▲ or ▼ keys will move group prompts forward or backward at a rate twice as fast.

Table 3-3 Configuration Procedure

Step	Operation	Press	Result
1	Set "LOCKOUT"	<b>SET UP</b>	until you see: Upper Display <b>SET UP</b> Lower Display <b>LOCKOUT</b>
2	Select "NONE" or "CALIB"	<b>FUNC</b>	until you see: Upper Display [ ] ← NONE CALIB Lower Display <b>LOCKOUT</b> +CONF +VIEW MAX Press the ▲ or ▼ keys to select None or Calib.
3	Select "OPTIONS" Set Up mode	<b>SET UP</b>	until you see: Upper Display <b>SET UP</b> Lower Display <b>OPTIONS</b>
4	Select STLR	<b>FUNC</b>	until you see: Upper Display [ ] ← NONE HTST Lower Display <b>PASTEUR</b> STLR FLOW Press the ▲ or ▼ keys to select STLR. (Default STLR configuration is loaded when the <b>FUNC</b> key is pressed. Refer to Section 5)
5	Select Reference Temperature Input (Optional)	<b>FUNC</b>	until you see: Upper Display [ ] ← DISABL ENABLE Lower Display <b>REF TEMP</b> Press the ▲ or ▼ keys to select ENABLE.

*Continued on next page*



### 3.4 Configuration, Continued

**Setting the lockout switch to LOCK**

After all the parameters are configured, refer to **Section 6 - Tests and Procedures for Model DR45AH - HTST (High Temperature Short Time) or Model DR45AS - STLR (Safety Thermal Limit Recorder)**.

**Future changes in configuration parameters**

After the Lockout Switch is placed in the ON (locked) position, the configuration parameters for Milk Diversion Valve control are “locked” (see “Restrictions”). If the Lockout switch is then sealed in the ON position, the configuration parameters may not be changed without first breaking the seal and then switching the Lockout switch to the OFF position.

To make configuration changes at some future time, follow the procedure in Table 3-4.

Table 3-4 Future Changes

Step	Action
1	Remove the security seal from the chart plate captive screw.
2	Open the chart plate and place the switch (S1) on the Main processor board in the OFF position.
3	Reconfigure the system and refer to <i>Section 6 - Tests and Procedures for Model DR45AH - HTST (High Temperature Short Time) or Model DR45AS - STLR (Safety Thermal Limit Recorder)</i> .
4	Place the switch (S1) on the Main processor board in the ON position, close the chart plate and add a security seal through the chart plate captive screw.

## 3.5 Operation

**STLR**  
(safety thermal limit recorder)

Figure 3-4 is a flow diagram of the milk pasteurization process. In the STLR process, milk flows from the raw milk supply tank through the plate-type heat exchanger, where it is heated to pasteurization temperature prior to entering the holding tube.

The tube size ensures that the milk remains at the pasteurization temperature for the required time.

Hot milk temperature is measured as it leaves the holding tube. If this temperature is above the pasteurization temperature, the DR45AS STLR allows milk flow to proceed to packaging or storage. If the milk is below pasteurization temperature, the DR45AS STLR diverts it to the raw milk tank for reprocessing.

For this application, DR45AS STLR uses one analog input, one digital input, and one on-off alarm to control the Flow diversion valve position.

Figure 3-4 Diagram of Milk Pasteurization Process

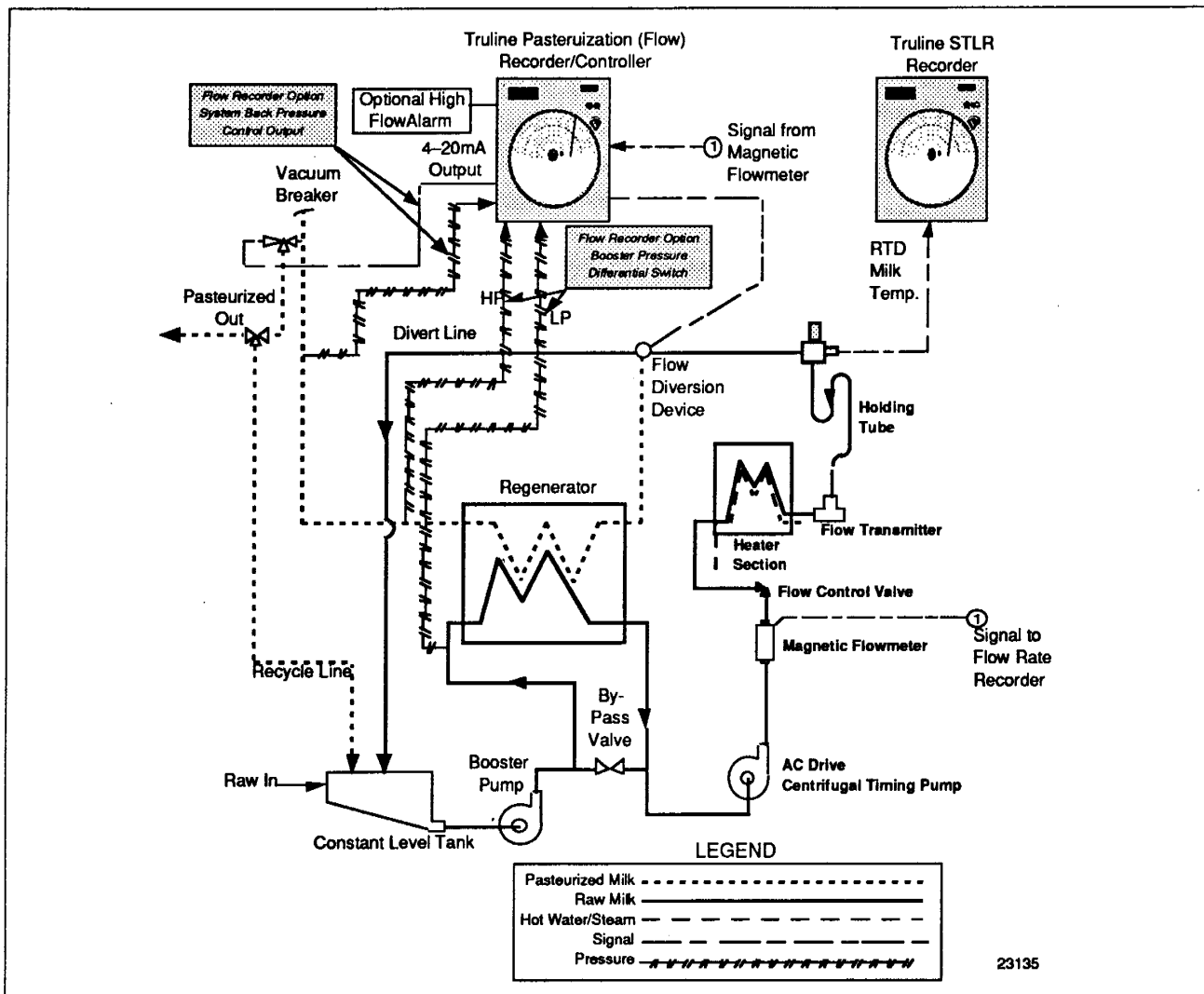

Continued on next page

## 3.5 Operation, Continued

**STLR (safety thermal limit recorder),**  
continued

---

Pasteurization control consists of recording the information shown on the circular chart (Figure 3-5) and implementing the following strategies:

1. The hot milk temperature is the first analog input (default display on power up) This temperature is recorded. The high-precision, fast response RTD sensor provides this temperature measurement. DR45AS STLR uses 100-ohm ( $\alpha = 0.00385$ ) platinum bulb actuation to provide hot milk temperature measurement accuracy of  $\pm 0.3^{\circ}\text{F}$ .
3. A switch on the flow diversion valve provides the digital input to activate the frequency pen that records the valve position on the outer portion of the chart. The user supplies and installs the two relays that connect the recorder to the pasteurizer system wiring.
4. When using inputs programmed as a digital reference measurement, the required RTD is a Fast Temperature response, Duplex RTD element, such as Model #21345(SP)-6-E-T11/2-2), available from RdF Corporation.

You can also record the flow diversion temperature setpoint without an additional analog input.

---

*Continued on next page*

### 3.5 Operation Continued

STLR (safety thermal limit recorder),  
continued

Figure 3-5 Simulated STLR Printed Chart

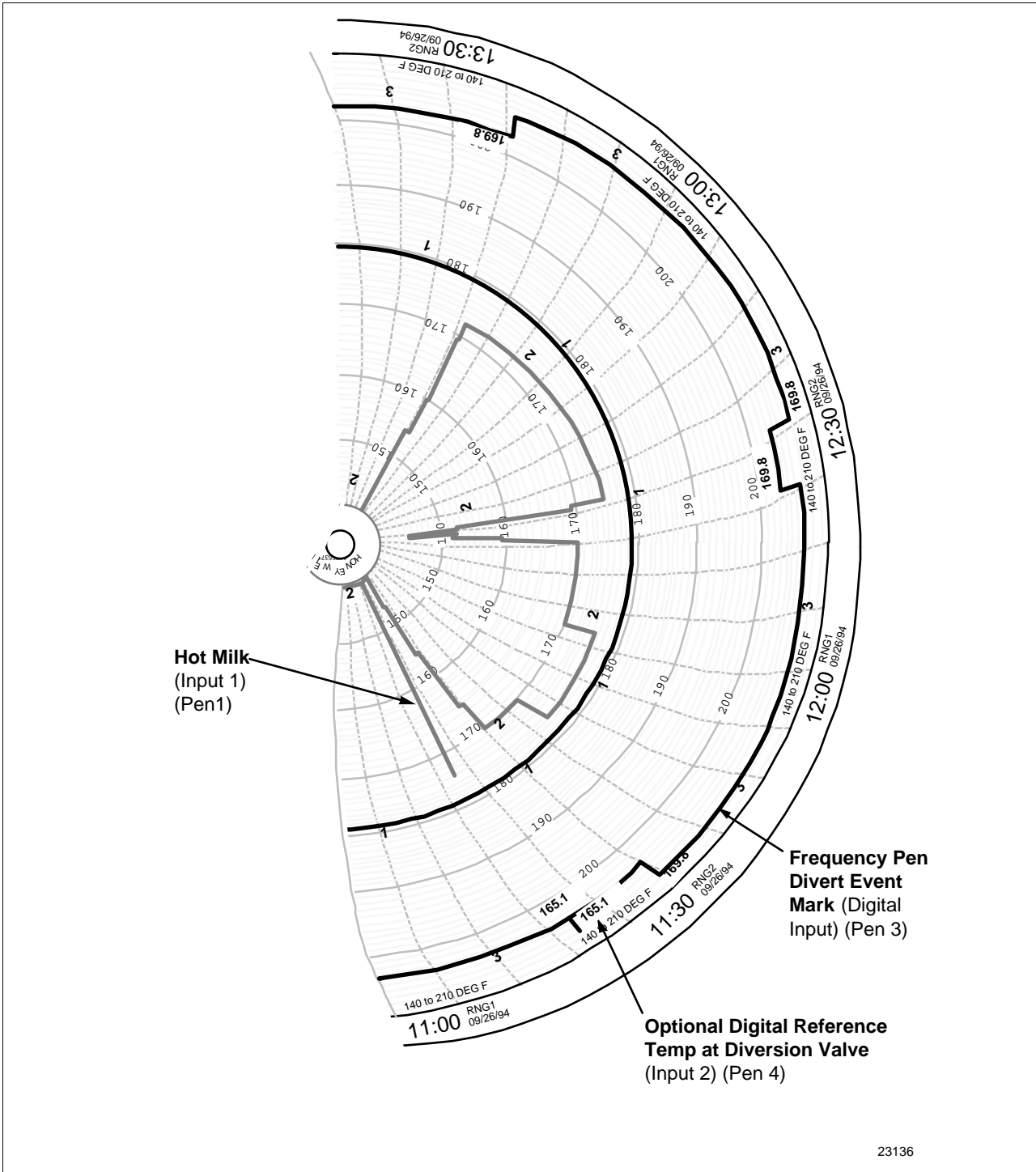

Continued on next page

## 3.5 Operation, Continued

---

### Flow diversion indication

On the DR45AS recorder, there is Flow Diversion Indication when Input 2 is programmed as a Digital Reference Temperature Indicator.

When a diversion occurs, the DR45AS recorder will automatically print on the chart, the temperature measured at the divert valve and then, when forward flow is resumed after the diversion, it will print the temperature again.

In addition, there are red and green indicator lights on the front of the recorder/controller that provide a visual indication of forward flow or flow diversion.

---

### Digital reference temperature display

The Digital Reference Temperature is displayed in the lower display on the recorder. It cannot be changed as long as the lockout switch is on. Pressing the lower display key will display other parameters in the upper display (IN1, IN2, IN3, IN4, SP1). The default hot milk temperature will return to the upper display 30 seconds after the last key press.

The Digital Reference Temperature will go blank if the recorder detects an input fault.

Because the hot milk input and the digital reference input each have an accuracy of  $\pm 0.3^{\circ}\text{F}$ , it is possible to have a difference of up to  $0.6^{\circ}\text{F}$  between the two. This difference can be eliminated by using the Input Compensation function in the Input 1/Input 2 (2 = Digital Reference Temperature, 1 = Hot Milk) Set up Groups.

The “INPTCOMP” function prompt under Set up groups “INPUT 1” and “INPUT 2” adds/subtracts a Bias from the input value to compensate for small inaccuracies in the input. By using this feature, both inputs can be made equal. This compensation, if necessary, should be done before the sanitarian’s seal is applied.

*(Refer to Subsection 3-11 in the Product Manual for bias adjustment information.)*

---

*Continued on next page*

## 3.5 Operation, Continued

---

### Speed of response test

The digital display for the Hot Milk temperature (default display on power up) must be used when doing the speed of response test as specified by the Grade A Pasteurized Milk Ordinance, U.S. Department of Health and Human Services.

If the Digital Reference Thermometer is enabled, the Hot Milk temperature is the default value in the upper display and the temperature of the Digital Reference Thermometer at the divert valve is in the lower display.

The Truline recorder uses a dot fill technique from a microprocessor algorithm to produce a continuous analog trace of a process variable. Every six seconds the recorder arm makes a pass across the chart paper and prints the record.

However, the digital display and the inputs to the recorder are updated three times per second with two inputs or  $2/3$  seconds with more than two inputs.

In addition, the milk temperature input, used for operating the diversion valve, is updated three times per second or three times every two seconds if more than 2 inputs are enabled.

Therefore, the response time for diversion on low temperature is not dependent on the record on the chart.

Also, if input filtering is used, it may affect the results of the speed of response test.

---

## Section 4– Model DR45AP - Pasteurization (Flow)

### 4.1 Overview

#### Introduction

The DR45AP Pasteurization Flow recorder/controller can be set up to control the flow rate in a pasteurization process.

In addition to the normal divert valve control provided, by high and low flow limit setpoints, optional inputs can be set up to display and record the Raw and Pasteurized pressures in the system.

The recorder/controller will display, in the lower display, the system high (pasteurized milk) and low (raw milk) pressures from independent pressure transmitters and control the system back pressure using the second control output from the recorder/controller.

In addition, a high pressure limit output value and a differential pressure low limit value can be set.

Optional red and green lights are available on the front of the recorder that provide a visual indication of forward flow (green) or flow diversion (red).

#### What's in this section

This section contains the following information:

	Topic	See Page
4.1	Overview	39
4.2	Field Wiring	40
4.3	Connection to System	42
4.4	Configuration	44
4.5	Operation	50

#### ATTENTION

After configuring the recorder, run the tests and perform the procedures listed in *Section 7 - Tests and Procedures for Model DR45AP - Pasteurization (Flow)*.

## 4.2 Field Wiring

---

**Simplified field wiring** Mount the recorder and wire the power and inputs as described in Product Manual 44-45-25-30.

Refer to Figures 4-1 and 4-2 for all other field wiring.

As shown in Figure 4-1, Control board #1 output is 4-20mA to the Timing Pump (Plug J1).

Relay #1 on control board #1 (Plug J5) serves as the ON/OFF control for the diverter valve.

Optional control board #2 output (4–20mA) is Booster Pump Control for Differential Pressure (System Back Pressure Control).

Relay #1 on control board #2 (Plug J5) is for the Booster pump control.

Relay #2 on control board #2 (Plug J5) is for high pressure limit alarm output.

Connect the leads from the SPST switch mounted on the flow diversion valve assembly to the Digital Input #1 (Plug J3 - Figure 4-1) through a latching relay (see Figure 4-2). Power is supplied to the contact from the recorder. The alarm relays, which have been connected to the optional indicator light assembly (Plug J4 - Figure 4-1), are then activated by the software depending on the state of this digital input.

---

*Continued on next page*



## 4.2 Field Wiring, Continued

**Output connection** Figure 4-1 is a diagram of output connections for the DR45AP Model (Flow Pasteurization).

Figure 4-1 Output Connections

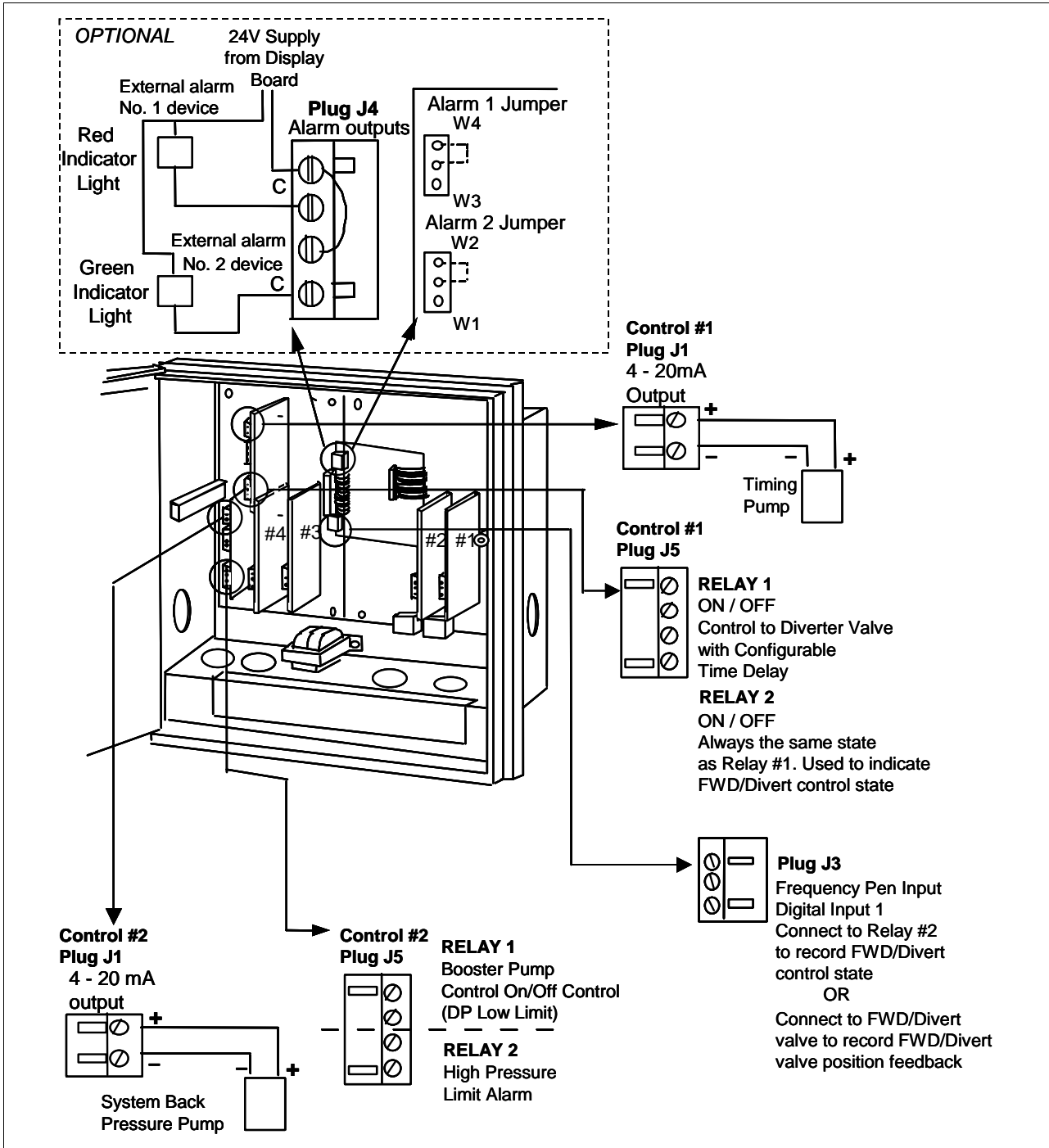

## 4.3 Connection to System

---

### Introduction

Two relays are required to interconnect the DR45AP recorder/controller to the HTST control system.

- Divert Relay Valve
- Diversion Switch relay

Figure 4-2 shows this wiring.

The terminals in Figure 4-2 that are designated by a box  are terminal numbers in the Pasteurizer Control Box. The designations are:

- 2 AC NEUTRAL
  - 3 AC HOT
  - 4 DIVERT
  - 5 LOW TEMPERATURE
  - 6 LEGAL
  - 7 FLOW FORWARD
- 

*Continued on next page*

### 4.3 Connection to System, Continued

**Connection diagram** Figure 4-2 is the Pasteurizer Control Box connection diagram for Model DR45AP.

Figure 4-2 Pasteurizer Control Box Connection Diagram - Model DR45AP

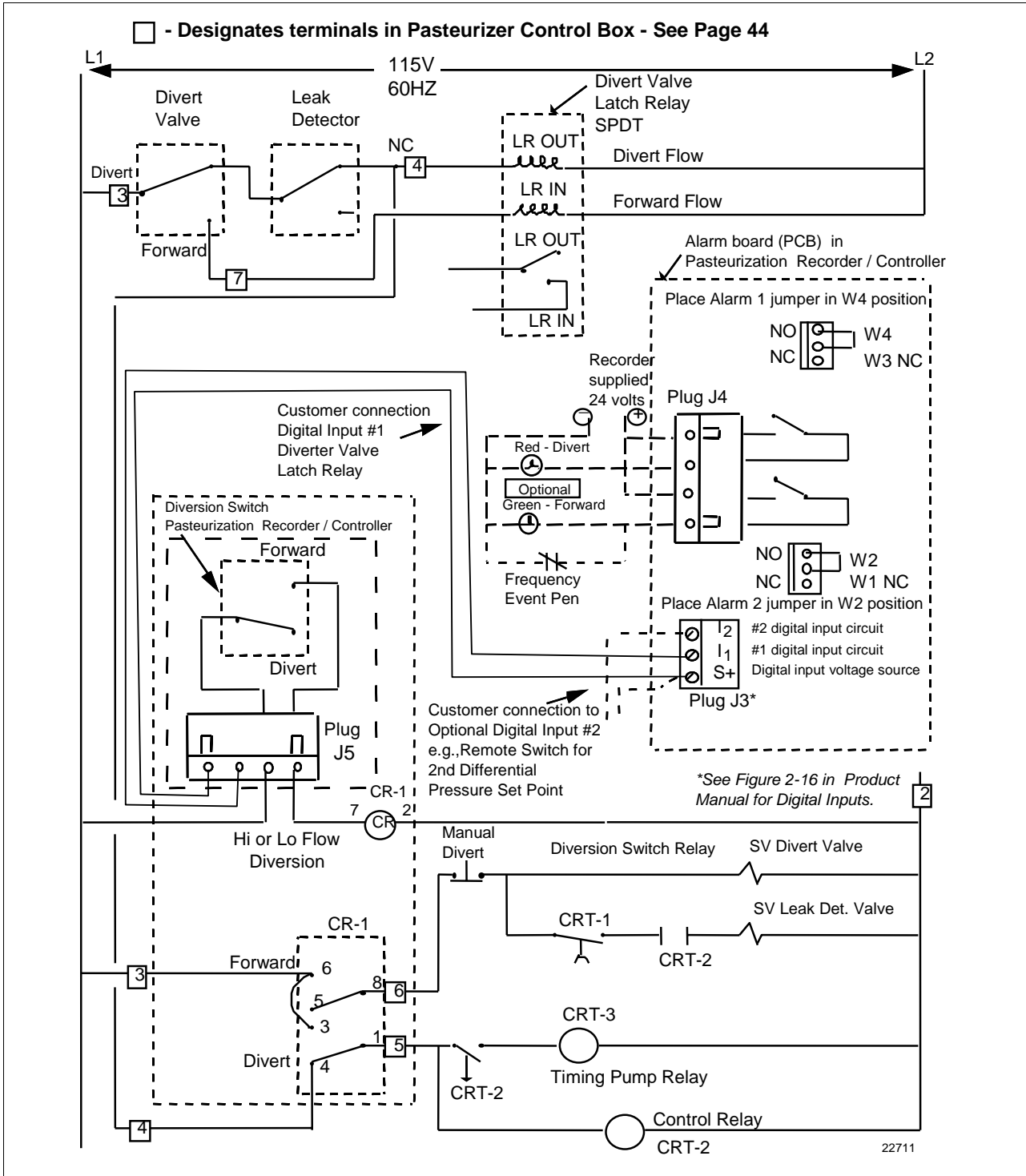

## 4.4 Configuration

### Restrictions based on lockout switch position

Figure 4-3 shows the location of the S1 Lockout Switch on the Main Printed Circuit board.

When the Lockout switch is OFF (**Down** - Configure):

- You can view and change all applicable operating parameters as described in Section 4 of this Addendum.

When the Lockout switch is ON (**Up** - Locked):

- Most parameters for Flow Controller are locked and the parameters may not be changed except for Control 1 and Control 2 tuning parameters and adjustments to time/date/day/year.

Figure 4-3 S1 Lockout Switch Location

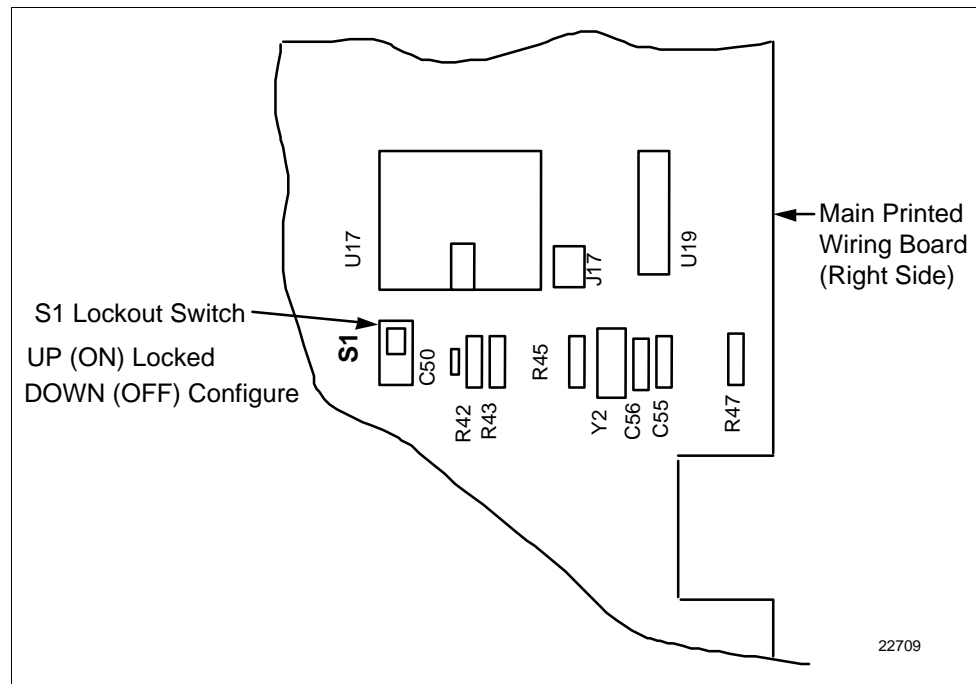

*Continued on next page*

## 4.4 Configuration, Continued

### Pens vs Inputs

The DR45AP Recorder/Controller can have up to 4 Analog Inputs and one Digital Input.

There are four pens to which these five inputs can be assigned. Some are required while others are optional. See Table 4-1.

Table 4-1 Input versus Pen Assignment Model DR45AP

INPUT	ASSIGNMENT	PEN
Analog Input #1	Flow	Any pen except #3
Analog Input #2	High Pressure* (pasteurized milk)	Any pen except #3
Analog Input #3	Low Pressure* (raw milk)	Any pen except #3
Analog Input #4	Any Indication	Any pen except #3
Digital Input	Divert Valve Position	Pen #3

\* The Pressure for the Hi and Lo system pressure is displayed in the Lower Display if DP is enabled.

*Continued on next page*

## 4.4 Configuration, Continued



### Configuration procedure



Follow the procedure in Table 4-2 to configure the DR45AP Flow recorder/controller.

**ATTENTION** The prompting scrolls at a rate of 2/3 seconds when the **SET UP** or **FUNC** key is held in. Also, **▲** or **▼** keys will move group prompts forward or backward at a rate twice as fast.

Table 4-2 Configuration Procedure

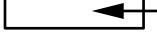
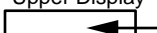
Step	Operation	Press	Result
1	Set "LOCKOUT"	<b>SET UP</b>	until you see: Upper Display <b>SET UP</b> Lower Display <b>LOCKOUT</b>
2	Select "NONE"	<b>FUNC</b>	until you see: Upper Display <b>NONE</b> <b>CALIB</b> Lower Display <b>LOCKOUT</b> <b>+CONF</b> <b>+VIEW</b> <b>MAX</b> Press the <b>▲</b> or <b>▼</b> keys to select NONE
3	Enable Input 2	<b>SET UP</b>	until you see: Upper Display <b>ENABL</b> <b>DISABL</b> Lower Display <b>INPUT 2</b> Press the <b>▲</b> or <b>▼</b> keys to select ENABLE <i>Both Input 2 and Input 3 required (enabled) for Differential Pressure Option (DIFF PRS) along with control 2 enabled.</i>
4	Enable Input 3	<b>SET UP</b>	until you see: Upper Display <b>ENABL</b> <b>DISABL</b> Lower Display <b>INPUT 3</b> Press the <b>▲</b> or <b>▼</b> keys to select ENABLE <i>Both Input 2 and Input 3 required (enabled) for Differential Pressure Option (DIFF PRS) along with control 2 enabled.</i>
5	Enable Control 2	<b>SET UP</b>	until you see: Upper Display <b>ENABL</b> <b>DISABLE</b> Lower Display <b>CONTROL 2</b> Press the <b>▲</b> or <b>▼</b> keys to select ENABLE.

Step	Operation	Press	Result
6	Select "OPTIONS" Set Up mode	<b>SET UP</b>	until you see: Upper Display <b>SET UP</b> Lower Display <b>OPTIONS</b>
7	Select FLOW	<b>FUNC</b>	until you see: Upper Display  NONE Lower Display <b>PASTEUR</b> HTST STLR FLOW Press the ▲ or ▼ keys to select FLOW. <b>(Default Flow configuration is loaded when the <b>FUNC</b> key is pressed. Refer to Section 5.)</b>
8	Select High Flow Limit Value	<b>FUNC</b>	until you see: Upper Display  High Flow Lower Display <b>HI FLOW</b> Limit Value Press the ▲ or ▼ keys to select the High Flow Limit value. The high flow limit can be viewed in the bottom display ( <b>fhi</b> ). Use <b>LOWR DISP</b> key.
9	Select Low Flow Limit Value	<b>FUNC</b>	until you see: Upper Display  Low Flow Lower Display <b>LO FLOW</b> Limit Value Press the ▲ or ▼ keys to select the Low Flow Limit value The low flow limit can be viewed in the bottom display ( <b>flo</b> ). Use <b>LOWR DISP</b> key.
10	Select Forward Delay Time Period	<b>FUNC</b>	until you see: Upper Display  Range: 0 to 60 seconds Lower Display <b>FWD DLAY</b> Press the ▲ or ▼ keys to select a value. The forward delay function sets a time period of from 0 to 60 seconds between when the flow value has reached a forward condition and when the relay actually switches to forward.

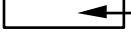
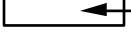
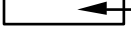
Step	Operation	Press	Result
11	Select Forward Hysteresis	<b>FUNC</b>	<p>until you see:</p> <p>Upper Display   Range: 0 to 5 %</p> <p>Lower Display  <b>FWD HYST</b></p> <p>Press the ▲ or ▼ keys to select a value.  <b>Forward Flo</b> will not begin until Limit + Hysteresis is satisfied.</p>
12	Enable Differential Pressure Function	<b>FUNC</b>	<p>until you see:</p> <p>Upper Display   ENABLE* *Input 2, Input 3,  and Control 2  Lower Display  DISABLE  <b>DIFF PRS</b></p> <p>Press the ▲ or ▼ keys to select ENABLE.  The differential pressure function measures and displays the differential (Input 2 – Input 3) and compares this value to the configured Lo DP Limit.  Control #2, Relay #1 is deactivated if the differential (DP) falls below the lo DP limit.  The value configured for “RLY HYST” applies here for reactivation of the relay.</p>
13	Select Differential Pressure Low Limit Value	<b>FUNC</b>	<p>until you see:</p> <p>Upper Display   Range: 0–100</p> <p>Lower Display  <b>DP LOLIM</b></p> <p><b>NOTE:DIFF PRS must be enabled</b></p> <p>Press the ▲ or ▼ keys to select a Differential Pressure Low Limit value.</p>
14	Select High Pressure Limit Value	<b>FUNC</b>	<p>until you see:</p> <p>Upper Display   Range: 0–100</p> <p>Lower Display  <b>HP LIMIT</b></p> <p><b>NOTE:DIFF PRS must be enabled</b></p> <p>Press the ▲ or ▼ keys to select a High Pressure Limit value.</p>
15	Select DP Time Delay	<b>FUNC</b>	<p>until you see:</p> <p>Upper Display   Range: 0–60</p> <p>Lower Display  <b>DP DELAY</b></p> <p>Press the ▲ or ▼ keys to select a Differential Pressure Time Delay value.</p>
16	Enter Values	<b>LOWR DISP</b>	All values are entered.



## 4.4 Configuration, Continued

---

**Tests and Procedures** After all the parameters are configured, refer to **Section 7 - Tests and Procedures for Model DR45AP - Pasteurization (Flow)**.

---

**Future changes in configuration parameters**

After the Lockout Switch is placed in the ON (locked) position, the configuration parameters for Milk Diversion Valve control are “locked” (see “Restrictions”). If the Lockout switch is then sealed in the ON position, the configuration parameters may not be changed without first breaking the seal and then switching the Lockout switch to the OFF position.

To make configuration changes at some future time, follow the procedure in Table 4-3.

Table 4-3 Future Changes

Step	Action
1	Remove the security seal from the chart plate captive screw.
2	Open the chart plate and place the switch (S1) on the Main processor board in the OFF position. (See Figure 4-3.)
3	Reconfigure the system and refer to <i>Section 7 - Tests and Procedures for Model DR45AP - Pasteurization (Flow)</i> .
4	Place the switch (S1) on the Main processor board in the ON position, close the chart plate and add a security seal through the chart plate captive screw.

---

## 4.5 Operation

---

### Flow

The DR45AP controls the flow rate in a pasteurization process (Figure 4-4).

The flow is controlled from the flow input from a pressure transmitter or a magnetic flowmeter in the constant flow line.

The recorder/controller uses Control Output #1 (PID control and a 4–20mA output) to control a variable speed pump which adjusts the flow rate in the system.

Diverts are based on High Flow or Low Flow setpoints configured in the recorder/controller. Diversion occurs when the flow rate is below the Low Flow setpoint or above the High Flow setpoint.

Control output #1, Relay #1 is the On/Off control to the diverter valve and has a configurable time delay that will occur before forward flow will begin after a diversion.

The Differential Pressure function uses pressure inputs from optional Inputs 2 and 3 to measure and display the high (pasteurized milk) and low (raw milk) system pressures (Input 2 – Input 3), and uses this value and Control output #2 (PID control and a 4–20mA output) to control the system back pressure pump. If the pressure differential drops below a pre-programmed level, Control output #2, Relay #1 is deactivated to turn on a pressure booster pump. There is a configurable time delay of up to 60 seconds that can be set before Control output #2, Relay #1 activates the pressure booster pump.

Control output #2, Relay #2 is the high pressure limit output and will deactivate when the pressure exceeds the high limit value set.

---

*Continued on next page*

# 4.5 Operation, Continued

## Flow, continued

Figure 4-4 Diagram of Flow Milk Pasteurization Process

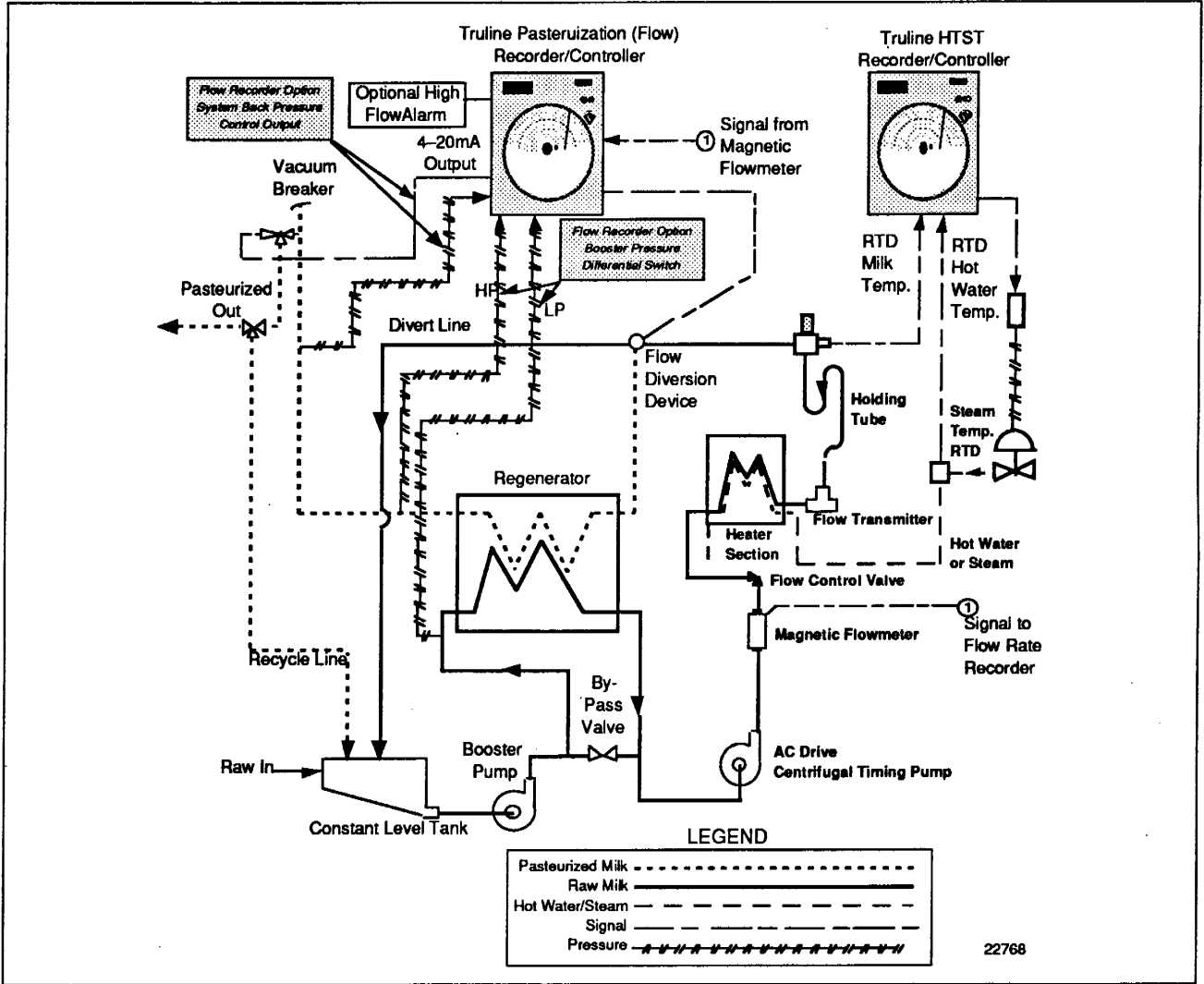

Continued on next page

## 4.5 Operation, Continued

---

### Flow, continued

For Pasteurization Flow, DR45AP uses one analog input for flow, one digital input, one 3-mode controller and one on-off controller to control:

- Process flow rate
- Flow diversion valve position

If controlling system back pressure, two additional analog inputs (Inputs 2 and 3) and one 3-mode, 4–20mA controller with two additional relay outputs is required.

Pasteurization flow control consists of recording the information shown on the circular chart (Figure 4-5) for input #1 flow and implementing the following strategies:

1. The first analog input is Process flow.
2. The second and third inputs and the second control output can be used to measure and record the system high and low pressure and to control the pressure differential ( $PV2 = IN2 - IN3$ ). SP2 is used to set to the desired pressure differential value.
3. The output signal from the Truline 4500AP to the FDV is recorded by the frequency pen and indicated by the indicator (divert) lights. The user supplies and installs the two relays that connect the recorder/controller to the pasteurizer system wiring.

You can also record the flow diversion temperature setpoint without an additional analog input.

In addition, optional red and green indicator lights are available on the front of the recorder/controller that provide a visual indication of forward flow or flow diversion.

---

*Continued on next page*





# Section 5 – Parameter Configuration Tables

## 5.1 Parameter Selections

### Introduction

The tables below list the pre-configured values that appear in the Recorder/Controller when you select “HTST”, “STLR”, or “FLOW” under configuration prompt “PASTEUR”.

If you want to change any of these values, refer to *Sections 6 and 7* in this addendum.

If you need an explanation or definition of any of these parameters, refer to *Section 4 - Parameter Definitions* in the Product Manual.

Those Set Up groups that are not applicable to Pasteurization are not shown.

Configuration procedures are listed in Sections 2, 3 and 4 in this addendum and in Section 3 of the Truline recorder product manual.

### Pre-configured values

#### Tuning 1 Group Function Prompts

Function Prompt <small>Lower Display</small>	Function Name	Selections or Range of Setting <small>Upper Display</small>	HTST Setting	STLR Setting	FLOW Setting
<b>GAIN</b>	Gain	0.1 to 1000	1.0	N/A	1.0
<b>RATE MIN</b>	Rate in minutes	0.08 to 10.00 minutes	0.00	N/A	0.00
<b>RSET MIN</b>	Reset in minutes/repeat	0.02 to 50.00	0.1	N/A	0.1
<b>MAN RSET</b>	Manual Reset	–100 to 100% output	N/A	N/A	N/A
<b>CYC SEC</b>	Cycle Time (Heat) Electromechanical Relays	1 to 120 seconds	N/A	N/A	N/A
<b>PROP BD2</b> or <b>GAIN 2</b>	Proportional Band 2, or Gain 2	0.1 to 1000%  0.1 to 1000	N/A	N/A	N/A
<b>RATE2MIN</b>	Rate 2 in minutes	0.08 to 10.00 minutes	N/A	N/A	N/A
<b>RSET2MIN</b>	Reset 2 in minutes/repeat	0.02 to 50.00	N/A	N/A	N/A
<b>RSET2RPM</b>	Reset 2 in repeats/minute	0.02 to 50.00			
<b>CYC2 SEC</b>	Cycle Time 2 (Cool) Electromechanical Relays	1 to 120 seconds	N/A	N/A	N/A

*Continued on next page*

## 5.1 Parameter Selections, Continued

### Tuning 2 Group Function Prompts

<b>Function Prompt</b> <small>Lower Display</small>	<b>Function Name</b>	<b>Selections or Range of Setting</b> <small>Upper Display</small>	<b>HTST Setting</b>	<b>STLR Setting</b>	<b>FLOW Setting</b>
<b>GAIN</b>	Gain	0.1 to 1000	N/A	N/A	1.0
<b>RATE MIN</b>	Rate in minutes	0.08 to 10.00 minutes	N/A	N/A	0.00
<b>RSET MIN</b>	Reset in minutes/repeat	0.02 to 50.00	N/A	N/A	0.1
<b>MAN RSET</b>	Manual Reset	-100 to 100% output	N/A	N/A	N/A
<b>CYC SEC</b>	Cycle Time (Heat) Electromechanical Relays	1 to 120 seconds	N/A	N/A	N/A
<b>PROP BD2</b> or <b>GAIN 2</b>	Proportional Band 2, or Gain 2	0.1 to 1000% 0.1 to 1000	N/A	N/A	N/A
<b>RATE2MIN</b>	Rate 2 in minutes	0.08 to 10.00 minutes	N/A	N/A	N/A
<b>RSET2MIN</b>	Reset 2 in minutes/repeat	0.02 to 50.00	N/A	N/A	N/A
<b>RSET2RPM</b>	Reset 2 in repeats/minute	0.02 to 50.00			
<b>CYC2 SEC</b>	Cycle Time 2 (Cool) Electromechanical Relays	1 to 120 seconds	N/A	N/A	N/A

*Continued on next page*



## 5.1 Parameter Selections, Continued

### Chart Group Function Prompts

Function Prompt Lower Display	Function Name	Selections or Range of Setting Upper Display	HTST Setting	STLR Setting	FLOW Setting
<b>CHRTSPD</b>	Chart Speed Selection	8HR 12HR 24HR 7DAYS XHR (See prompt "HOUR/REV")	XHR	XHR	XHR
<b>HOUR/REV</b>	Hours per Revolution (appears only if "XHR" is selected above)	6 to 744 (12 hrs for abrasion resistant pen) <b>ATTENTION</b> Below 8 hrs chart speed (24 hrs chart speed with abrasion resistant pen), printing may be degraded.	12HR	12HR	12HR
<b>TIME DIV</b>	Time Division	8 to 24 time periods	12	12	12
<b>CONTINUE</b>	Continue Chart Rotation	YES NO	NO	NO	NO
<b>CHARTNAM</b>	Chart Name	0 to 9 A to Z + - / (blank)	TRULIN	TRULIN	TRULIN
<b>HEADER</b>	Header for Chart	YES NO	NO	NO	NO
<b>REM CHRT</b>	Remote Chart Activation	NONE EXT SW1 EXT SW2 ALARM 1 ALARM 2 TIME (See "WAKE MIN", "WAKE HOUR", "WAKE DAY", & "WAKE MON".) SHED	NONE	NONE	NONE
<b>WAKE MIN</b>	Wake Minutes	0 to 59	N/A	N/A	N/A
<b>WAKE HOUR</b>	Wake Hour	0 to 23	N/A	N/A	N/A
<b>WAKE DAY</b>	Wake Day	0 to 31	N/A	N/A	N/A
<b>WAKE MON</b>	Wake Month	1 to 12	N/A	N/A	N/A

Continued on next page

## 5.1 Parameter Selections, Continued

### Pen 1 Group Function Prompts

Function Prompt Lower Display	Function Name	Selections or Range of Setting Upper Display	HTST Setting	STLR Setting	FLOW Setting
<b>PEN 1</b>	Pen Record	ENABLE DISABL	ENABLE	ENABLE	ENABLE
<b>PEN1IN</b>	Pen Input	INPUT 1, 2, 3, or 4 (if enabled)  RH OUTPT1 OUTPT2 SETPT1 SETPT2 DGTL1 DGTL2 PV1	INPUT 1	INPUT 1	INPUT 1
<b>CHART1HI</b>	Chart High Range Value	-999.0 to 999	210.0	210.0	100.0
<b>CHART1LO</b>	Chart Low Range Value	-999.0 to 999	140.0	140.0	0.0
<b>PEN1ON</b>	Pen Chart Position for ON Event	0 to 100%	N/A	N/A	N/A
<b>PEN1OFF</b>	Pen Chart Position for OFF Event	0 to 100%	N/A	N/A	N/A
<b>MAJORDIV</b>	Major Chart Divisions	2 to 10	7	7	10
<b>MINORDIV</b>	Minor Chart Division	2 to 10	10	10	10
<b>RNG1TAG</b>	Range 1 Tag Name	0 to 9 A to Z + - / (blank)	RNG 1	RNG 1	RNG 1

*Continued on next page*

## 5.1 Parameter Selections, Continued

### Pen 2 Group Function Prompts

Function Prompt Lower Display	Function Name	Selections or Range of Setting Upper Display	HTST Setting	STLR Setting	FLOW Setting
<b>PEN 2</b>	Pen Record	ENABLE DISABL	ENABLE	ENABLE	ENABLE
<b>PEN2IN</b>	Pen Input	INPUT 1, 2, 3, or 4 (if enabled)  RH OUTPT1 OUTPT2 SETPT1 SETPT2 DGTL1 DGTL2 PV1	INPUT 2	INPUT 2	INPUT 2
<b>CHART2HI</b>	Chart High Range Value	-999.0 to 999	210.0	210.0	50.0
<b>CHART2LO</b>	Chart Low Range Value	-999.0 to 999	140.0	140.0	0.0
<b>PEN2ON</b>	Pen Chart Position for ON Event	0 to 100%	N/A	N/A	N/A
<b>PEN2OFF</b>	Pen Chart Position for OFF Event	0 to 100%	N/A	N/A	N/A
<b>MAJORDIV</b>	Major Chart Divisions	2 to 10	7	7	10
<b>MINORDIV</b>	Minor Chart Division	2 to 10	10	10	10
<b>RNG2TAG</b>	Range 2 Tag Name	0 to 9 A to Z + - / (blank)	RNG 2	RNG 2	RNG 2

*Continued on next page*

## 5.1 Parameter Selections, Continued

### Pen 3 Group Function Prompts

Function Prompt Lower Display	Function Name	Selections or Range of Setting Upper Display	HTST Setting	STLR Setting	FLOW Setting
<b>PEN 3</b>	Pen Record	ENABLE DISABL	ENABLE	ENABLE	ENABLE
<b>PEN3IN</b>	Pen Input	INPUT3 RH OUTPT1 OUTPT2 SETPT1 SETPT2 DGTL1 DGTL2 PV1	DGTL1	DGTL2	DGTL1
<b>CHART3HI</b>	Chart High Range Value	-999.0 to 999	N/A	N/A	N/A
<b>CHART3LO</b>	Chart Low Range Value	-999.0 to 999	N/A	N/A	N/A
<b>PEN3ON</b>	Pen Chart Position for ON Event	0 to 100%	94.2	94.2	94.2
<b>PEN3OFF</b>	Pen Chart Position for OFF Event	0 to 100%	90.0	90.0	90.0
<b>MAJORDIV</b>	Major Chart Divisions	2 to 10	10	10	10
<b>MINORDIV</b>	Minor Chart Division	2 to 10	10	10	10
<b>RNG3TAG</b>	Range 3 Tag Name	0 to 9 A to Z + - / (blank)	RNG 3	RNG 3	RNG 3

*Continued on next page*

## 5.1 Parameter Selections Continued

Pen 4 can be used to record the diversion setpoint if desired, without the addition of another input card, by configuration. If another Process Variable is to be recorded, such as cold milk, another input card and sensor is required. The following values are arbitrary for Pen 4. They must be changed to be consistent with your application.

### Pen 4 Group Function Prompts

<b>Function Prompt</b> <small>Lower Display</small>	<b>Function Name</b>	<b>Selections or Range of Setting</b> <small>Upper Display</small>	<b>HTST Setting</b>	<b>STLR Setting</b>	<b>FLOW Setting</b>
<b>PEN 4</b>	Pen Record	ENABLE DISABL	DISABL	DISABL	DISABL
<b>PEN4IN</b>	Pen Input	INPUT 1, 2, 3, or 4 (if enabled)  RH OUTPT1 OUTPT2 SETPT1 SETPT2 DGTL1 DGTL2 PV1	INPUT 1	INPUT 1	INPUT 1
<b>CHART4HI</b>	Chart High Range Value	-999.0 to 999	775.0	775.0	50.0
<b>CHART4LO</b>	Chart Low Range Value	-999.0 to 999	765.0	765.0	0.0
<b>PEN4ON</b>	Pen Chart Position for ON Event	0 to 100%	N/A	N/A	N/A
<b>PEN4OFF</b>	Pen Chart Position for OFF Event	0 to 100%	N/A	N/A	N/A
<b>MAJORDIV</b>	Major Chart Divisions	2 to 10	7	7	10
<b>MINORDIV</b>	Minor Chart Division	2 to 10	10	10	10
<b>RNG4TAG</b>	Range 4 Tag Name	0 to 9 A to Z + - / (blank)	RNG 4	RNG 4	RNG 4

*Continued on next page*

## 5.1 Parameter Selections, Continued

### Input 1 Group Function Prompts

Function Prompt Lower Display	Function Name	Selections or Range of Setting Upper Display	HTST Setting	STLR Setting	FLOW Setting
<b>DECIMAL</b>	Decimal Point Location	XXXX None XXX.X One XX.XX Two	XXX.X	XXX.X	XXX.X
<b>UNITS</b>	Temperature Units	DEG F DEG C XXXXX (make selection at prompt "ENGUNITS")	DEG F	DEG F	XXXXX
<b>ENGUNITS</b>	Engineering Units		N/A	N/A	GPM
<b>IN1 TYPE</b>	Input 1 Actuation Type	B TC      W TC H E TC H    W TC L E TC L    100 PT J TC H    200 HI J TC L    200 LO K TC H    500 PT K TC L    100 RH NNM TC   4-20mA NIC TC    0-10mV R TC      10-50m S TC      0-5 V T TC H    0-10V T TC L    RADIAM	100 RH  (This is selected to achieve a higher accuracy over the 100PT actuation)	100 RH  (This is selected to achieve a higher accuracy over the 100PT actuation)	4-20mA
<b>XMITTER</b>	Transmitter Characterization		N/A	N/A	LINEAR
<b>IN1 HI</b>	Input 1 High Range Value	-999.0 to 9999. in engineering units	392	392	100.0
<b>IN1 LO</b>	Input 1 Low Range Value (linear inputs only)	-999.0 to 9999. in engineering units	-130	-130	0.0
<b>INPTCOMP</b>	Input Compensation	-999.9 to 9999.	0.0	0.0	0.0
<b>FILTER 1</b>	Input 1 Filter	0 to 120 seconds*	0.0	0.0	0.0
<b>BURNOUT</b>	Burnout Protection	NONE UP DOWN	UP	UP	UP

\*NOTE: To insure recorder meets speed of response testing, filter value should be set to 1 second or less.

*Continued on next page*

## 5.1 Parameter Selections, Continued

### Input 2 Group Function Prompts

Function Prompt Lower Display	Function Name	Selections or Range of Setting Upper Display	HTST Setting	STLR Setting	FLOW Setting
<b>DECIMAL</b>	Decimal Point Location	XXXX None XXX.X One XX.XX Two	XXX.X	XXX.X	XXX.X
<b>UNITS</b>	Temperature Units	DEG F DEG C XXXXX (make selection at prompt "ENGUNITS")	DEG F	DEG F	XXXXX
<b>ENGUNITS</b>	Engineering Units		N/A	N/A	PSIG
<b>IN2 TYPE</b>	Input 2 Actuation Type	B TC      W TC H E TC H    W TC L E TC L    100 PT J TC H    200 HI J TC L    200 LO K TC H    500 PT K TC L    100 RH NNM TC   4-20mA NIC TC   0-10mV R TC      10-50m S TC      0-5 V T TC H    0-10V T TC L    RADIAM	100 RH	100 RH	4-20mA
<b>XMITTER</b>	Transmitter Characterization		N/A	N/A	LINEAR
<b>IN2 HI</b>	Input 2 High Range Value	-999.0 to 9999. in engineering units	392	392	100.0
<b>IN2 LO</b>	Input 2 Low Range Value (linear inputs only)	-999.0 to 9999. in engineering units	-130	-130	0.0
<b>INPTCOMP</b>	Input Compensation	-999.9 to 9999.	0.0	0.0	0.0
<b>FILTER 2</b>	Input 2 Filter	0 to 120 seconds*	0.0	0.0	0.0
<b>BURNOUT</b>	Burnout Protection	NONE UP DOWN  NOTE: When in HTST mode, the burnout for input 2 (Hot Milk) is set to DOWN and cannot be changed.	DOWN	DOWN	UP

\*NOTE: To insure recorder meets speed of response testing, filter value should be set to 1 second or less.

*Continued on next page*

## 5.1 Parameter Selections, Continued

### Input 3 Group Function Prompts

Function Prompt Lower Display	Function Name	Selections or Range of Setting Upper Display	HTST Setting	STLR Setting	FLOW Setting
<b>DECIMAL</b>	Decimal Point Location	XXXX None XXX.X One XX.XX Two	XXX.X	XXX.X	XXX.X
<b>UNITS</b>	Temperature Units	DEG F DEG C XXXXX (make selection at prompt "ENGUNITS")	DEG F	DEG F	XXXXX
<b>ENGUNITS</b>	Engineering Units		N/A	N/A	PSIG
<b>IN3TYPE</b>	Input 3 Actuation Type	B TC      W TC H E TC H    W TC L E TC L    100 PT J TC H    200 HI J TC L    200 LO K TC H    500 PT K TC L    100 RH NNM TC   4-20mA NIC TC    0-10mV R TC      10-50m S TC      0-5 V T TC H    0-10V T TC L    RADIAM	100 RH	100 RH	4-20mA
<b>XMITTER</b>	Transmitter Characterization		N/A	N/A	LINEAR
<b>IN3 HI</b>	Input 3 High Range Value	-999.0 to 9999. in engineering units	392	392	100.0
<b>IN3 LO</b>	Input 3 Low Range Value (linear inputs only)	-999.0 to 9999. in engineering units	-130	-130	0.0
<b>INPTCOMP</b>	Input Compensation	-999.9 to 9999.	0.0	0.0	0.0
<b>FILTER 3</b>	Input 3 Filter	0 to 120 seconds*	0.0	0.0	0.0
<b>BURNOUT</b>	Burnout Protection	NONE UP DOWN	UP	UP	UP

\*NOTE: To insure recorder meets speed of response testing, filter value should be set to 1 second or less.

*Continued on next page*



## 5.1 Parameter Selections, Continued

### Input 4 Group Function Prompts

Function Prompt Lower Display	Function Name	Selections or Range of Setting Upper Display	HTST Setting	STLR Setting	FLOW Setting
<b>DECIMAL</b>	Decimal Point Location	XXXX None XXX.X One XX.XX Two	XXX.X	XXX.X	XXX.X
<b>UNITS</b>	Temperature Units	DEG F DEG C XXXXX (make selection at prompt "ENGUNITS")	DEG F	DEG F	DEG F
<b>ENGUNITS</b>	Engineering Units		N/A	N/A	N/A
<b>IN4TYPE</b>	Input 4 Actuation Type	B TC      W TC H E TC H    W TC L E TC L    100 PT J TC H    200 HI J TC L    200 LO K TC H    500 PT K TC L    100 RH NNM TC   4-20mA NIC TC    0-10mV R TC      10-50m S TC      0-5 V T TC H    0-10V T TC L    RADIAM	100 RH	100 RH	100 RH
<b>XMITTER</b>	Transmitter Characterization		N/A	N/A	N/A
<b>IN4 HI</b>	Input 4 High Range Value	-999.0 to 9999. in engineering units	392	392	392
<b>IN4 LO</b>	Input 4 Low Range Value (linear inputs only)	-999.0 to 9999. in engineering units	-130	-130	-130
<b>INPTCOMP</b>	Input Compensation	-999.9 to 9999.	0.0	0.0	0.0
<b>FILTER 4</b>	Input 4 Filter	0 to 120 seconds*	0.0	0.0	0.0
<b>BURNOUT</b>	Burnout Protection	NONE UP DOWN	UP	UP	UP

\*NOTE: To insure recorder meets speed of response testing, filter value should be set to 1 second or less.

*Continued on next page*

## 5.1 Parameter Selections, Continued

### Control 1 Group Function Prompts

Function Prompt Lower Display	Function Name	Selections or Range of Setting Upper Display	HTST Setting	STLR Setting	FLOW Setting
<b>PID SETS</b>	Tuning Parameter Sets	1 ONLY 2KEYBD 2PV SW 2SP SW	1 ONLY	1 ONLY	1 ONLY
<b>SW VALUE</b>	Automatic Switchover Value	-999.0 to 9999	N/A	N/A	N/A
<b>SP SOURC</b>	Setpoint Source	1 LOCAL REMOTE 2 LOCAL COMSP	1 LOCAL	1 LOCAL	1 LOCAL
<b>RATIO</b>	Ratio for Remote Setpoint	-20.00 to 20.00	N/A	N/A	N/A
<b>BIAS</b>	Bias for Remote Setpoint	-999.0 to 9999 in engineering units	N/A	N/A	N/A
<b>SP TRACK</b>	Setpoint Tracking	NONE RSP	N/A	N/A	N/A
<b>POWER UP</b>	Power Up Controller Mode Recall	MANUAL A LSP A RSP AMSP AMLSP	A LSP	A LSP	A LSP
<b>SP HILIM</b>	High Setpoint Limit	-999.0 to 9999.	190.0	175.0	100.0
<b>SP LOLIM</b>	Low Setpoint Limit	-999.0 to 9999.	150.0	157.0	0.0
<b>ACTION</b>	Control Output Direction	DIRECT REVRSE	REVERS E	DIRECT	REVERS E
<b>OUTHILIM</b>	High Output Limit	-5.0 to 105.0% of output	100.0	100.0	100.0
<b>OUTLOLIM</b>	Low Output Limit	-5.0 to 105.0% of output	0	0	0
<b>DROPOFF</b>	Controller Dropoff Value	-5.0 to 105.0% of output	0.0	0.0	0.0

*Continued on next page*

## 5.1 Parameter Selections, Continued

### Control 1 Group Function Prompts, continued

Function Prompt Lower Display	Function Name	Selections or Range of Setting Upper Display	HTST Setting	STLR Setting	FLOW Setting
<b>DEADBAND</b>	Output Relay Deadband	<ul style="list-style-type: none"> <li>• <i>Time Proportional Duplex:</i> –5.0 to 25.0%</li> <li>• <i>On-Off Duplex:</i> 0.0 to 25.0%</li> <li>• <i>Position Proportional</i> 0.5 to 5.0%</li> </ul>	N/A	N/A	N/A
<b>OUT HYST</b>	Output Relay Hysteresis	0.0 to 5.0% of PV Span	0.0	0.5	0.0
<b>FAILSAFE</b>	Failsafe Output Value	0 to 100%	0.0	0.0	0.0
<b>REM SW</b>	Remote Switching (Digital Input)	NONE TO MAN TO LSP TO 2SP TO DIR RN/HLD	NONE	NONE	NONE
<b>MAN KEY</b>	Manual Mode Key Selection	ENABLE DISABL	ENABLE	ENABLE	ENABLE
<b>PBorGAIN</b>	Proportional Band or Gain Units	PB PCT GAIN	GAIN	GAIN	GAIN
<b>MINorRPM</b>	Reset Units	R P M (repeats per minute) M I N (minutes per repeat)	MIN	MIN	MIN
<b>CONT1 ALG</b>	Control Algorithm	ON-OFF PID-A PID-B PD+MR	PID-A	ON-OFF	PID-A
<b>OUT1 ALG</b>	Output Algorithm	TIME CURRNT POSITN TIME D CUR TI TI CUR	CURREN T	TIME	CURREN T
<b>4–20RNG</b>	Current/Time Duplex Range (CUR D)	100PCT (FULL) 50 PCT (SPLIT)	N/A	N/A	N/A
<b>SHEDMODE</b>	Shed Controller Mode and Output Level	LAST TO MAN FSAFE	N/A	N/A	N/A
<b>SHED SP</b>	Shed Setpoint Recall	TO LSP TO CSP	N/A	N/A	N/A

Continued on next page

## 5.1 Parameter Selections, Continued

### Control 2 Group Function Prompts

Function Prompt Lower Display	Function Name	Selections or Range of Setting Upper Display	HTST Setting	STLR Setting	FLOW Setting
<b>PID SETS</b>	Tuning Parameter Sets	1 ONLY 2KEYBD 2PV SW 2SP SW	N/A	N/A	1 ONLY
<b>SW VALUE</b>	Automatic Switchover Value	-999.0 to 9999	N/A	N/A	N/A
<b>SP SOURC</b>	Setpoint Source	1 LOCAL REMOTE 2 LOCAL COMSP	1 LOCAL	1 LOCAL	1 LOCAL
<b>RATIO</b>	Ratio for Remote Setpoint	-20.00 to 20.00	N/A	N/A	N/A
<b>BIAS</b>	Bias for Remote Setpoint	-999.0 to 9999 in engineering units	N/A	N/A	N/A
<b>SP TRACK</b>	Setpoint Tracking	NONE RSP	N/A	N/A	N/A
<b>POWER UP</b>	Power Up Controller Mode Recall	MANUAL A LSP A RSP AM SP AMLSP	A LSP	A LSP	A LSP
<b>SP HILIM*</b>	High Setpoint Limit(Loop2)	-999.0 to 9999.	175	175	50
<b>SP LOLIM*</b>	Low Setpoint Limit(Loop2)	-999.0 to 9999.	157	157	0
<b>ACTION</b>	Control Output Direction	DIRECT REVRSE	DIRECT	DIRECT	REVERSE
<b>OUTHILIM</b>	High Output Limit	-5.0 to 105.0% of output	100.0	100.0	100.0
<b>OUTLOLIM</b>	Low Output Limit	-5.0 to 105.0% of output	0	0	0
<b>DROPOFF</b>	Controller Dropoff Value	-5.0 to 105.0% of output	0.0	0.0	0.0
<b>DEADBAND</b>	Output Relay Deadband	<ul style="list-style-type: none"> <li>• <i>Time Proportional Duplex:</i> -5.0 to 25.0%</li> <li>• <i>On-Off Duplex:</i> 0.0 to 25.0%</li> <li>• <i>Position Proportional</i> 0.5 to 5.0%</li> </ul>	N/A	N/A	N/A

\* The 2nd loop setpoint is adjustable. Setpoint limits are set at these prompts.

*Continued on next page*

## 5.1 Parameter Selections, Continued

### Control 2 Group Function Prompts, continued

Function Prompt Lower Display	Function Name	Selections or Range of Setting Upper Display	HTST Setting	STLR Setting	FLOW Setting
<b>OUT HYST</b>	Output Relay Hysteresis	0.0 to 5.0 in Engineering Units	0.0	0.0	0.0
<b>FAILSAFE</b>	Failsafe Output Value	0 to 100%	0.0	0.0	0.0
<b>REM SW</b>	Remote Switching (Digital Input)	NONE TO MAN TO LSP TO 2SP TO DIR RN/HLD	NONE	NONE	NONE
<b>MAN KEY</b>	Manual Mode Key Selection	ENABLE DISABL	ENABLE	ENABLE	ENABLE
<b>PBorGAIN</b>	Proportional Band or Gain Units	PB PCT GAIN	GAIN	GAIN	GAIN
<b>MINorRPM</b>	Reset Units	R P M (repeats per minute) M I N (minutes per repeat)	MIN	MIN	MIN
<b>CONT2 ALG</b>	Control Algorithm	ON-OFF PID-A PID-B PD+MR	ON-OFF	ON-OFF	PID-A
<b>OUT2 ALG</b>	Output Algorithm	TIME CURRNT POSITN TIME D CUR TI TI CUR	TIME	TIME	CURREN T
<b>4-20RNG</b>	Current/Time Duplex Range (CUR D)	100PCT (FULL) 50 PCT (SPLIT)	N/A	N/A	N/A
<b>SHEDMODE</b>	Shed Controller Mode and Output Level	LAST TO MAN FSAFE	N/A	N/A	N/A
<b>SHED SP</b>	Shed Setpoint Recall	TO LSP TO CSP	N/A	N/A	N/A

*Continued on next page*

## 5.1 Parameter Selections, Continued

### Options Group Function Prompts

Function Prompt Lower Display	Function Name	Selections or Range of Setting Upper Display	HTST Setting	STLR Setting	FLOW Setting
<b>INPUT 1</b>	Input 1 Actuation	DISABL ENABLE	ENABLE	ENABLE	ENABLE
<b>INPUT 2</b>	Input 2 Actuation	DISABL ENABLE	ENABLE	Depends on Model	Depends on Model
<b>INPUT 3</b>	Input 3 Actuation	DISABL ENABLE	Depends on Model	Depends on Model	Depends on Model
<b>INPUT 4</b>	Input 4 Actuation	DISABL ENABLE	Depends on Model	Depends on Model	Depends on Model
<b>CONTROL 1</b>	Control 1 Loop	DISABL ENABLE	ENABLE	ENABLE	ENABLE
<b>CONTROL 2</b>	Control 2 Loop	DISABL ENABLE	ENABLE	DISABL	Depends on Model
<b>REJ FREQ</b>	Rejection Frequency	50HZ 60HZ	60HZ	60HZ	60HZ
<b>AUX OUT</b>	Auxiliary Output Representation	DISABL IN 1 IN 2 PV 1 DEV 1 OUT 1 SP 1 PV 2 DEV 2 OUT 2 SP 2 IN 3 IN 4	DISABL	DISABL	DISABL
<b>4 mA VAL</b>	Low Scaling Factor	value to represent 4 mA	0	0	0
<b>20mA VAL</b>	High Scaling Factor	value to represent 20 mA	100	100	100
<b>HF REJ</b>	High Frequency Rejection	ENABLE DISABL	DISABL	DISABL	DISABL
<b>PASTEUR</b>	Pasteurization Function	NONE HTST STLR FLOW	NONE	NONE	NONE
<b>REF TEMP</b> <sup>1</sup>	Reference Temperature	DISABL ENABLE	DISABL	DISABL	N/A
<b>REF ALRM</b> <sup>1</sup>	Digital Reference Alarm	0.5 to 5	0.5	N/A	N/A
<b>HI FLOW</b> <sup>2</sup>	High Limit Value		N/A	N/A	90.0
<b>LO FLOW</b> <sup>2</sup>	Low Limit Value		N/A	N/A	95.0
<b>FWD DLAY</b> <sup>2</sup>	Forward Delay	0 to 60	N/A	N/A	15
<b>DIFF PRS</b> <sup>3</sup>	DiffPress Function	ENABLE or DISABLE	N/A	N/A	DISABL
<b>HP LIMIT</b> <sup>3</sup>	High Pressure Limit	0 to 100	N/A	N/A	40
<b>DP LOLIM</b> <sup>3</sup>	Diff. Press. Low Limit	0 to 100	N/A	N/A	5
<b>DP DELAY</b>	DP Low Limit Relay Delay	0 to 60	N/A	N/A	15

<sup>1</sup> Appears only if PASTEUR selection = **HTST**

<sup>2</sup> Appears only if PASTEUR selection = **FLOW**

Note : The balance of the prompts in this group are not applicable

<sup>3</sup>Appears if PASTEUR = Flow

INPUT 2 = Enable

INPUT 3 = Enable

CONTROL 2 = Enable

*Continued on next page*

## 5.1 Parameter Selections, Continued

### Adjust Printing Group Function Prompts

<b>Function Prompt</b> <small>Lower Display</small>	<b>Function Name</b>	<b>Selections or Range of Setting</b> <small>Upper Display</small>	<b>HTST Setting</b>	<b>STLR Setting</b>	<b>FLOW Setting</b>
<b>TRACE LN</b>	Trace Line Contrast	DARK MEDIUM LIGHT	MEDIUM	MEDIUM	MEDIUM
<b>GRID LN</b>	Grid Line Contrast	DARK MEDIUM LIGHT	MEDIUM	MEDIUM	MEDIUM
<b>PEN TYPE</b>	Stylus Selection	NORMAL JEWEL	NORMA L	NORMA L	NORMA L





# Section 6 – Testing Procedures for Model DR45AH - HTST (High Temperature Short Time) or Model DR45AS - STLR (Safety Thermal Limit Recorder)

## 6.1 Overview

### Introduction

This section contains procedures which should be done:

- prior to putting the HTST Recorder/Controller or STLR Recorder into service
- any time a process value is changed
- at regular intervals (every three months is recommended).

The tests and procedures should be done in the order listed below:

- Configuration check or reconfiguration
- Calibration test
- Indicating Thermometers - Temperature accuracy
- Recording Thermometers - Temperature accuracy
- Recording Thermometers - Time accuracy
- Recording Thermometers - Check against Indicating Thermometers
- Indicating Thermometers - Thermometric response
- Recorder/Controller - Thermometric response
- Milk Flow Controls Milk Temperature at Cut-in and Cut-out
- Locking and Sealing Instrument and Sensor

### What's in this section

This section contains the following information:

	Topic	See Page
6.1	Overview	73
6.2	Configuration Check or Reconfiguration	74
6.3	Calibration Test	79
6.4	Indicating Thermometers Temperature Accuracy – Test 1, PMO 2003	84
6.5	Recording Thermometers Temperature Accuracy – Test 2, PMO 2003	85
6.6	Recording Thermometers Time Accuracy – Test 3, PMO 2003	87
6.7	Recording Thermometers Check Against Indicating Thermometers – Test 4 – PMO 2003	88
6.8	Milk Flow Controls Milk Temperature at Cut-in and Cut-out – Test 10, PMO 2003	89
6.9	Indicating Thermometers Thermometric Response – Test 7, PMO 2003	91
6.10	Recorder/Controller Thermometric Response – Test 8, PMO 2003	93
6.11	Locking and Sealing Instrument and Sensor	95

## 6.2 Configuration Check or Reconfiguration

---

<b>Application</b>	Applies to all Truline Recorder/Controllers used on continuous flow pasteurizers.
<b>Frequency</b>	Upon installation and whenever a configured value is changed.
<b>Criteria</b>	A set of configured values will be automatically entered in the Recorder/Controller when step #5 in Table 6-1 is performed. In some cases, these values may have to be changed to meet the requirements of the application.
<b>Apparatus</b>	None
<b>Method</b>	<p>The regulating official shall scan through the configuration prompts and the associated values after performing the steps under the Automatic HTST or STLR Configuration procedure (Table 6-1) and reset any value required (Table 6-2). The default values are found in Section 5 of this addendum (HTST or STLR Setting).</p> <p>The procedure for reconfiguring the values is listed in Subsection 3.5 of the Product Manual, 44-45-25-30, supplied with each Recorder/Controller.</p>
<b>Start Up</b>	<p>When power is applied to the recorder, it will run through a self-test program which will take approximately 10 seconds. During this test period, there are no control signals from the recorder/controller to the process.</p> <p>The flow diversion valve will remain in the divert position.</p> <p>At the end of this test, the digital display in the upper left corner of the case will indicate “TEST DONE”.</p> <p>The display will then start reading the No. 1 input value in the upper display and the setpoint value in the lower display:</p>

---

Upper Display  
CHN 1 XX.X

Lower Display  
SP XX.X

*Continued on next page*













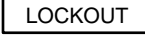

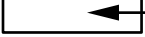

## 6.2 Configuration Check or Reconfiguration, Continued

### HTST or STLR automatic configuration

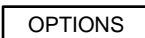
Follow the procedure in Table 6-1 to allow the HTST or STLR configuration values to be automatically entered into memory.

Open the door of the recorder, open the chart plate and place the switch (S1) on the Main processor board in the OFF position.

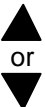
Table 6-1 Automatic HTST or STLR Configuration

Step	Operation	Press	Result
1	Set "LOCKOUT"		until you see: Upper Display  Lower Display 
2	Select "NONE"		until you see: Upper Display  NONE Lower Display  CALIB +CONF +VIEW MAX  Press the  or  keys to select NONE
3	Select "OPTIONS" Set Up mode		until you see:   
5	Select HTST or STLR		until you see: Upper Display  NONE Lower Display  HTST STLR FLOW
		 or 	to select <b>HTST</b> or <b>STLR</b>
6	Automatic entry		and the <b>HTST or STLR</b> configuration values are entered as listed in <i>Section 5 (HTST or STLR Setting)</i> in this addendum.

Continued on next page

## 6.2 Configuration Check or Reconfiguration, Continued

### HTST or STLR automatic configuration, continued

The other configuration values on the recorder will have automatically been entered when the HTST or STLR option was selected. They should be reviewed to determine that they are correct for each application. This can be done by pressing the **SET UP** key to get to a group function as indicated in the lower display and then use the **FUNC** key to check each value setting within that group.

After selecting the HTST or STLR option, any of the configuration values may be changed. Refer to Table 6-2 for the procedure.

### Reconfiguration

If any of the configuration values that were entered when HTST or STLR option was selected need to be changed, follow the procedure in Table 6-2.

Open the door of the recorder, open the chart plate and place the switch (S1) on the Main processor board in the OFF position.

Table 6-2 Reconfiguration









Step	Operation	Press	Result
1	Set "LOCKOUT"	<b>SET UP</b>	until you see: Upper Display <b>SET UP</b> Lower Display <b>LOCKOUT</b>
2	Select "NONE"	<b>FUNC</b>	until you see: Upper Display <b>NONE</b> Lower Display <b>LOCKOUT</b> NONE CALIB +CONF +VIEW MAX Press the ▲ or ▼ keys to select NONE
3	Select Set Up mode	<b>SET UP</b>	until you see: Upper Display <b>SET UP</b> Lower Display <b>TUNING 1</b> Lets you know you are in the configuration mode and a Set Up group title is being displayed in the lower display. This is the first Set Up group title.

Table continued on next page

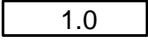
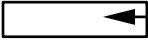
## 6.2 Configuration Check or Reconfiguration, Continued

### Reconfiguration, continued

Table 6-2 Reconfiguration, continued

Step	Operation	Press	Result
4	Select any Set Up group		<ul style="list-style-type: none"> <li>• Successive presses of the <b>SET UP</b> key will sequentially display the other Set Up group titles.</li> <li>• You can also use the ▲ or ▼ keys to scan the Set Up groups in both directions.</li> <li>• Stop at the Set Up group title which describes the group of parameters you want to reconfigure. Then proceed to the next step.</li> </ul>
5	Select a Function Parameter		<p>Upper Display   Shows the current value or selection for the first function prompt of the particular Set Up group that you have selected.</p> <p>Lower Display   ← PROP BAND or GAIN            Depending on what is selected in Set Up group "Control." Shows the first function prompt within that Set Up group.</p> <p>Example displays show Set Up group "Tuning", function prompt "Prop Band or Gain" and the value selected.</p>
6	Select other Function Parameters		<ul style="list-style-type: none"> <li>• Successive presses of the <b>FUNC</b> key will sequentially display the other function prompts of the Set Up group you have selected.</li> <li>• Stop at the function prompt that you want to change, then proceed to the next step.</li> </ul>
7	Change the value or selection	 or 	<ul style="list-style-type: none"> <li>• These keys increment or decrement the value or selection that appears for the function prompt you have selected.</li> <li>• Change the value or selection to meet your needs.</li> <li>• If the display flashes, you are trying to make an unacceptable entry.</li> </ul>
8	Enter the value or selection	 or 	<ul style="list-style-type: none"> <li>• This key selects another function prompt.</li> <li>• This key selects another Set Up group.</li> </ul> <p>The value or selection you have made will be entered into memory after another key is pressed.</p>
9	Exit Configuration		<p>This exits configuration mode and returns the recorder to the same state it was in immediately preceding entry into the Set Up mode. It stores any changes you have made.</p>

*Continued on next page*

## 6.2 Configuration Check or Reconfiguration, Continued

### No communications option

The Communications Option will not be offered in this model. Confirm that Communications is not in the recorder.

- Open the door, unscrew the hold down screw for the chart plate and open it.
- Check that the communications card is not in the recorder. See Figure 6-1 for card location.

Figure 6-1 Communications Card Location

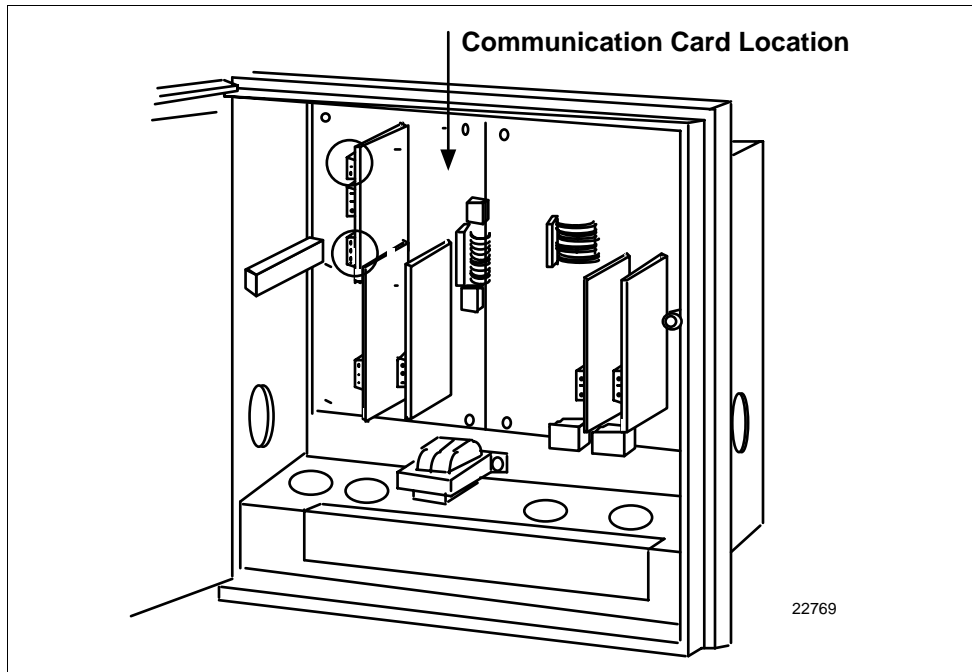

### Auto/Manual keys

The functions of the Auto/Manual keys are limited to the hot water temperature controller. These keys will not affect the diversion temperature setpoint, the frequency event marking, or the hot milk temperature recording.

They cannot operate the flow diversion valve.

### Technical assistance

If the configuration values cannot be set or changed as described in this subsection or for other problems, contact the Honeywell Technical Assistance Center:

**1-800-423-9883**

## 6.3 Calibration Test

---

<b>Application</b>	Applies to all Truline Recorder/Controllers used in connection with continuous flow pasteurizers.
<b>Frequency</b>	Upon installation and every three months thereafter.
<b>Criteria</b>	The recorder/controller must not read higher than the corresponding indicating thermometer. This test must be conducted prior to cut-in and cut-out temperature testing.
<b>Apparatus</b>	An indicating thermometer that has been calibrated with a thermometer traceable to or certified by the National Institute of Science and Technology, and an oil or water bath with a control system capable of maintaining a mean bath temperature of $\pm 0.5^{\circ}\text{F}$ ( $\pm 0.3^{\circ}\text{C}$ ).
<b>Method</b>	The calibrated thermometer and the sensing element for the recorder/controller milk temperature are immersed in the continuously agitated oil or water bath. The temperature of the indicating thermometer is compared to the recorder/controller temperature reading. If the two readings differ, the recorder/controller is adjusted to read the same as the standard indicating thermometer.

---

*Continued on next page*



## 6.3 Calibration Test, Continued

### Procedure

Table 6-3 lists the steps to perform the calibration test for HTST Models. Table 6-4 lists the steps to perform the calibration test for STLR Models.

Table 6-3 Calibration Test for HTST Models

Step	Action
1	Adjust the water or oil bath to a temperature approximately 2°F (1°C) above the diversion temperature. Make sure there is sufficient agitation in the bath to maintain a uniform temperature.
2	<p>Press the <b>LOWR DISP</b> key until you see:</p> <div style="text-align: center;">  </div> <p>Immerse both the indicating thermometer and the milk temperature sensor in the bath. Allow three to four minutes for the temperature to stabilize.</p>
3	Record both temperatures and determine the difference, if any, between the two readings. If there is a difference, go to Step 4.
4	<p>Adjust the recorder/controller temperature to read the same as the standard indicating thermometer.</p> <p>Press the <b>SET UP</b> key until you see:</p> <div style="text-align: center;">  </div> <p>Press the <b>FUNC</b> key until you see:</p> <div style="text-align: center;">  </div> <p>Press the ▲ or ▼ keys to enter the compensation in temperature units (°F) to make the recorder read the same value as the standard thermometer. The entered compensation value is applied to the incoming temperature signal. All functions within the recorder will use this compensated value.</p> <p><b>If you are using Input 1 as a Digital Reference Temperature, go to step 6.</b></p>

Table continued next page

## 6.3 Calibration Test, Continued

Procedure, continued

Table 6-3 Calibration Test for HTST Models, continued

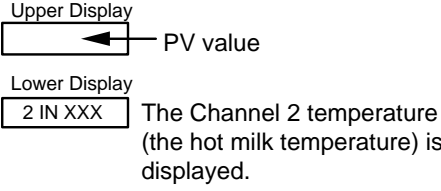
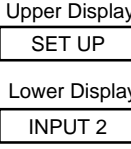
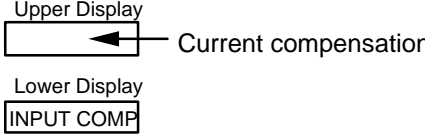
Step	Action
5	Record the compensation adjustment value for the office record.
6	<p>Check the Digital Reference Temperature (Input 1) to make sure it reads the same as Input 2 (Hot Milk Temperature) and the standard indicating thermometer.</p> <p><b>The Digital Reference Temperature is the default display in the lower display of the recorder if the lockout switch is ON. otherwise, press the <b>LOWR DISP</b> key until “IN2 XXX” appears in the lower display to show the Hot Milk Temperature.</b></p> <p>If this temperature is different from Input 2 and the standard indicating thermometer, go to Step 7.</p>
7	<p>Adjust Input 1 temperature to read the same as the Input 2 and standard indicating thermometer.</p> <p>Press the <b>SET UP</b> key until you see:</p> <div style="text-align: center;"> <p>Upper Display</p> <div style="border: 1px solid black; padding: 2px; display: inline-block;">SET UP</div> </div> <div style="text-align: center; margin-top: 10px;"> <p>Lower Display</p> <div style="border: 1px solid black; padding: 2px; display: inline-block;">INPUT 1</div> </div> <p>Press the <b>FUNC</b> key until you see:</p> <div style="text-align: center;"> <p>Upper Display</p> <div style="border: 1px solid black; padding: 2px; display: inline-block;"> <span style="font-size: 2em;">←</span> </div> <span style="margin-left: 10px;">Current compensation</span> </div> <div style="text-align: center; margin-top: 10px;"> <p>Lower Display</p> <div style="border: 1px solid black; padding: 2px; display: inline-block;">INPUT COMP</div> </div> <p>Press the ▲ or ▼ keys to enter the compensation in temperature units (°F) to make the recorder read the same value as Input 2. The entered compensation value is applied to the incoming temperature signal.</p>

*Continued on next page*

## 6.3 Calibration Test, Continued

**Procedure, continued** Table 6-4 lists the steps to perform the calibration test for STLR Models.

Table 6-4 Calibration Test for STLR Models

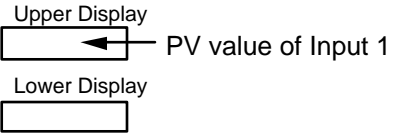
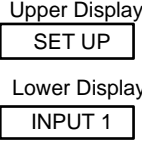
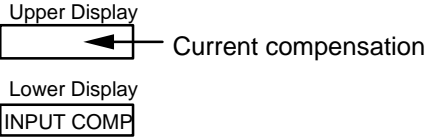
Step	Action
1	Adjust the water or oil bath to a temperature approximately 2°F (1°C) above the diversion temperature. Make sure there is sufficient agitation in the bath to maintain a uniform temperature.
2	<p>Press the <b>LOWR DISP</b> key until you see:</p> <div style="text-align: center;">  <p>Upper Display  <span style="border: 1px solid black; padding: 2px;">PV value of Input 1</span>            Lower Display  <span style="border: 1px solid black; padding: 2px;"> </span></p> </div> <p>Immerse both the indicating thermometer and the milk temperature sensor in the bath. Allow three to four minutes for the temperature to stabilize.</p>
3	Record both temperatures and determine the difference, if any, between the two readings. If there is a difference, go to Step 4.
4	<p>Adjust the recorder/controller temperature to read the same as the standard indicating thermometer.</p> <p>Press the <b>SET UP</b> key until you see:</p> <div style="text-align: center;">  <p>Upper Display  <span style="border: 1px solid black; padding: 2px;">SET UP</span>            Lower Display  <span style="border: 1px solid black; padding: 2px;">INPUT 1</span></p> </div> <p>Press the <b>FUNC</b> key until you see:</p> <div style="text-align: center;">  <p>Upper Display  <span style="border: 1px solid black; padding: 2px;">Current compensation</span>            Lower Display  <span style="border: 1px solid black; padding: 2px;">INPUT COMP</span></p> </div> <p>Press the ▲ or ▼ keys to enter the compensation in temperature units (°F) to make the recorder read the same value as the standard thermometer. The entered compensation value is applied to the incoming temperature signal. All functions within the recorder will use this compensated value.</p> <p><b><i>If you are using Input 2 as a Digital Reference Temperature, go to step 6.</i></b></p>

*Table continued next page*

## 6.3 Calibration Test, Continued

Procedure, continued

Table 6-4 Calibration Test for STLR Models, continued

Step	Action
5	Record the compensation adjustment value for the office record.
6	<p>Check the Digital Reference Temperature (Input 2) to make sure it reads the same as Input 1 (Hot Milk Temperature) and the standard indicating thermometer.</p> <p><b>The Digital Reference Temperature is the default display in the lower display of the recorder if the lockout switch is ON. otherwise, press the <b>LOWR DISP</b> key until “IN1XXX” appears in the lower display to show the Hot Milk Temperature.</b></p> <p>If this temperature is different from Input 1 and the standard indicating thermometer, go to Step 7.</p>
7	<p>Adjust Input 2 temperature to read the same as the Input 1 and standard indicating thermometer.</p> <p>Press the <b>SET UP</b> key until you see:</p> <div style="text-align: center;"> <p>Upper Display</p> <div style="border: 1px solid black; padding: 2px; display: inline-block;">SET UP</div> </div> <div style="text-align: center; margin-top: 10px;"> <p>Lower Display</p> <div style="border: 1px solid black; padding: 2px; display: inline-block;">INPUT 2</div> </div> <p>Press the <b>FUNC</b> key until you see:</p> <div style="text-align: center;"> <p>Upper Display</p> <div style="border: 1px solid black; padding: 2px; display: inline-block;"> <span style="font-size: 2em;">←</span> </div> <span style="margin-left: 10px;">Current compensation</span> </div> <div style="text-align: center; margin-top: 10px;"> <p>Lower Display</p> <div style="border: 1px solid black; padding: 2px; display: inline-block;">INPUT COMP</div> </div> <p>Press the ▲ or ▼ keys to enter the compensation in temperature units (°F) to make the recorder read the same value as Input 1. The entered compensation value is applied to the incoming temperature signal.</p>

## 6.4 Indicating Thermometers Temperature Accuracy – Test 1, PMO 2003

<b>Application</b>	Applies to all indicating thermometers used for measurement of milk temperature during pasteurization.
<b>Frequency</b>	Upon installation and at least once every three months.
<b>Criteria</b>	Within $\pm 0.5^{\circ}\text{F}$ ( $\pm 0.25^{\circ}\text{C}$ ), in specified scale range.
<b>Apparatus</b>	Test thermometer meeting specifications under Appendix I, Part 1 of the <i>Pasteurized Milk Ordinance 2003</i> ; water or oil bath and agitator; suitable means of heating water or oil bath.
<b>Method</b>	Both thermometers are exposed to a water or oil medium of uniform temperature. Indicating thermometer reading is compared to the reading of the test thermometer.
<b>Procedure</b>	Table 6-5 lists the steps for testing the temperature accuracy of an indicating thermometer.

Table 6-5 Temperature Accuracy Test for Indicating Thermometers

Step	Action
1	Heat 10 gallons (38 liters) of water in a milk can, or a quantity of oil in an oil bath, to within a range of $3^{\circ}\text{F}$ ( $2^{\circ}\text{C}$ ) of the appropriate pasteurization temperature.
2	Remove heat source and agitate water or oil bath rapidly.
3	Continue agitation. Insert indicating test thermometer to indicated immersion point during the test.
4	Compare both thermometer readings at the temperature reading within the test range.
5	Repeat comparison of readings.
6	Record thermometer readings and thermometer identification or location.

<b>Corrective action</b>	When the indicating thermometer differs from the test thermometer by more than $0.5^{\circ}\text{F}$ ( $0.25^{\circ}\text{C}$ ), the indicating thermometer should be recalibrated, per the procedure in Section 7 of the Product Manual, to agree with the test thermometer. Retest the thermometer after adjustment. If the indicating thermometer still does not agree, then the indicating thermometer should be repaired.
--------------------------	--

## 6.5 Recording Thermometers Temperature Accuracy – Test 2, PMO 2003

<b>Application</b>	Applies to all recording and recorder/controller thermometers used to record milk temperatures during pasteurization.
<b>Frequency</b>	Upon installation, at least once every three months, and whenever recording pen-arm setting requires frequency adjustment.
<b>Criteria</b>	Within $\pm 1^{\circ}\text{F}$ ( $\pm 0.5^{\circ}\text{C}$ ), in specified scale range.
<b>Apparatus</b>	Pasteurizer indicating thermometer previously tested against a known accurate thermometer; three 38 liters (10-gallon) milk cans, or suitable vats or containers; agitator; suitable means of heating water baths; and ice.
<b>Method</b>	The testing of a recording thermometer for temperature accuracy involves the determination of whether or not the temperature pen-arm will return to within $1^{\circ}\text{F}$ ( $0.5^{\circ}\text{C}$ ) of its previous setting after exposure to boiling water and melting ice.
<b>Procedure</b>	Table 6-6 lists the steps for testing the temperature accuracy of a recording thermometer.

Table 6-6 Temperature Accuracy Test for Recording Thermometers

Step	Action
1	Adjust the recording pen to read exactly as the previously tested indicating thermometer, after a stabilization period of five minutes at a constant temperature within the temperature range for the pasteurization process being used. The water bath must be rapidly agitated throughout the stabilization period.  To adjust the recorder, refer to <i>Section 6.3 Calibration Test</i> .
2	Heat one water bath to the boiling point; maintain temperature. Place melting ice in a second container.  Place both water baths within working distance of the recorder sensing element.
3	Immerse the sensing element of the recorder in the boiling water for at least five minutes.
4	Adjust a can of water to a temperature within the testing range for the pasteurization process being used.

*Table continued on next page*

## 6.5 Recording Thermometers Temperature Accuracy – Test 2, PMO 2003, Continued

Procedure, continued

Table 6-6 Temperature Accuracy Test for Recording Thermometers, continued

Step	Action
5	Remove the sensing element from the boiling water and immerse in the can of water whose temperature was adjusted in the previous step. Allow a five minute stabilization period for both indicating and recording thermometers.  Compare the readings. The pen arm should return to within 1°F (0.5°C) of the indicating thermometer reading.
6	Remove the sensing element from the bath that is set at operating temperatures, and immerse it in the melting ice for a minimum of five minutes.
7	Remove the sensing element from the ice water and immerse it again in the bath set at operating temperatures. Allow a five minute stabilization period for both indicating and recording thermometers.  Compare the readings. The pen arm should return to within 1°F (0.5°C) of the indicating thermometer reading.
8	Record the results.

### Corrective action

If the pen does not return to  $\pm 1^\circ\text{F}$  ( $\pm 0.5^\circ\text{C}$ ) of the indicating thermometer reading, the recording thermometer should be repaired.

**ATTENTION** When this test is performed on recorder/controllers used with HTST or STLR pasteurization systems, an oil bath must be substituted for the boiling water in Step 3 of Table 6-6. The temperature of the oil bath should cause the temperature sensing element of the recorder/controller system to be raised to a temperature above that which the recorder/controller is capable of sensing.

## 6.6 Recording Thermometers Time Accuracy – Test 3, PMO 2003

<b>Application</b>	Applies to all recording and recorder/controller thermometers used to record time of pasteurization.
<b>Frequency</b>	Upon installation, and at least once every three months thereafter.
<b>Criteria</b>	The recorded time of pasteurization will not exceed the true elapsed time.
<b>Apparatus</b>	A watch graduated at intervals not to exceed one minute, and accurate to within five minutes in 24 hours; and a pair of dividers, or any other suitable device for measuring short distances.
<b>Method</b>	Comparison of the recorded time over a period of not less than 30 minutes with a watch of known accuracy. For recorders utilizing electric clocks, check cycle on faceplate of clock with known cycle; observe that clock is in operating condition.
<b>Procedure</b>	Table 6-7 lists the steps for testing the time accuracy of a recording thermometer.

Table 6-7 Time Accuracy Test for Recording Thermometers

Step	Action
1	Make sure you have the appropriate chart for the recorder.
2	At the start of the holding period, inscribe a reference mark at the pen point on the recorder chart and record the time.
3	At the end of 30 minutes by the watch, inscribe a second reference mark on the chart at the pen point position.
4	Determine the distance between the two reference marks and compare the distance with the time scale divisions on the record chart at the same temperature.
5	<i>For electric clocks</i> , remove the faceplate and compare the cycle specification on the faceplate with the current cycle utilized.
6	Enter the finding on the chart and initial. Record results.

<b>Corrective action</b>	If the recorded time is incorrect, the clock should be adjusted or repaired.
--------------------------	--



## 6.7 Recording Thermometers Check Against Indicating Thermometers – Test 4, PMO 2003

**Application** Applies to all recording and recorder/controller thermometers used to record milk temperatures during pasteurization.

**Frequency** At least once every three months by regulatory agency, daily by plant operator.

**Criteria** Recording thermometers will not read higher than corresponding indicating thermometer.

**Apparatus** None

**Method** This test requires only that the reading of the recording thermometer be compared with that of the indicating thermometer at a time when both are exposed to milk at a stabilized pasteurization temperature.

**Procedure** Table 6-8 lists the steps for comparing the readings of the recording thermometer and the indicating thermometer.

Table 6-8 Recording Thermometer Reading vs. Indicating Thermometer Reading Test

Step	Action
1	While milk is at a stabilized pasteurization temperature, read the indicating thermometer.
2	Immediately inscribe, on the recording thermometer chart, a line intersecting the recorded temperature arc at the pen location; record the indicating thermometer temperature on the chart, initial.
3	Record the results.

**Corrective action** If the recording thermometer reads higher than the indicating thermometer, the pen should be adjusted by the operator. To adjust the recorder, refer to *Section 6.3 Calibration Test*.

## 6.8 Milk Flow Controls Milk Temperatures at Cut-in and Cut-out – Test 10, PMO 2003

<b>Application</b>	Applies to all recorder/controllers used in connection with HTST pasteurizers except those in which the flow diversion device is located at the end of the cooler section.
<b>Frequency</b>	Upon installation and quarterly by the regulatory agency; daily by the plant operator.
<b>Criteria</b>	No forward flow until pasteurization temperature has been reached. Flow diverted before temperature drops below minimum pasteurization temperature.
<b>Apparatus</b>	None
<b>Method</b>	By observing the actual temperature of the indicating thermometer at the instant forward flow starts (cut-in) and stops (cut-out).  With digital reference the unit does this for you. You only need to observe that the digital reference and hot milk agree and that divert pen indication happens.
<b>Procedure</b>	Table 6-9 lists the steps for observing the actual milk temperatures at cut-in and cut-out.

Table 6-9 Milk Temperatures at Cut-in and Cut-out Test

Step	Action
1	<p>Observe and record the cut-in temperature.</p> <p>While milk or water is completely flooding the sensing element of the recorder/controller and the indicating thermometer, increase the heat gradually so as to raise the temperature of the water or milk at a rate not exceeding 1°F (0.5°C) every 30 seconds.</p> <p>Observe the indicating thermometer reading at the moment the forward flow starts (i.e., flow diversion device moves). Observe that the frequency pen reading is synchronized with the recording pen on the same reference arc. (If you are using digital reference, you only need to observe that the digital reference temperature and the hot milk agree, and that divert pen indication happens.)</p> <p>Record the indicating thermometer reading on the recorder chart; inscribe initials. The regulatory agency will record test findings.</p>
2	<p>Observe and record the cut-out temperature.</p> <p>After the cut-in temperature has been determined and while the milk or water is above the cut-in temperature, allow the water to cool slowly at a rate not exceeding 1°F (0.5°C) per 30 seconds.</p> <p>Observe the indicating thermometer reading at the instant forward flow stops. (If you are using digital reference, you only need to observe that the digital reference temperature and the hot milk agree, and that divert pen indication happens.)</p> <p>Record the indicating thermometer reading on the recorder chart.</p>

*Continued on next page*



## 6.8 Milk Flow Controls Milk Temperatures at Cut-in and Cut-out – Test 10, PMO 2003, Continued

### Corrective action

If the reading is below the minimum pasteurization temperature, the cut-in and cut-out mechanism and/or the differential temperature mechanism should be adjusted to obtain proper cut-in and cut-out temperatures by repeated tests.

Adjust the cut-in/cut-out milk diversion setpoint using the procedure in Table 6-10.

Table 6-10 Adjusting the Milk Diversion Setpoint Setting

Step	Action
1	<p>Press the <b>LOWR DISP</b> key until you see:</p> <p style="text-align: center;">Upper Display  <div style="border: 1px solid black; padding: 2px; display: inline-block;">CH2 XXXX</div></p> <p style="text-align: center;">Lower Display  <div style="border: 1px solid black; padding: 2px; display: inline-block;">SP2 XXXX</div></p> <p style="text-align: right;">Denotes the setpoint for controller 2 which is the milk diversion setpoint.</p>
2	Press  or  key to adjust the diversion setpoint.
3	Press the <b>LOWR DISP</b> key to enter the new setpoint value. The digital display will return to indicate process conditions.

## 6.9 Indicating Thermometers Thermometric Response – Test 7, PMO 2003

<b>Application</b>	Applies to all indicating thermometers located on pipelines and used for determination of milk temperatures during pasteurization.
<b>Frequency</b>	Upon installation and at least once every three months.
<b>Criteria</b>	Four seconds under specified conditions.
<b>Apparatus</b>	Test thermometer, stopwatch, water bath 10-gallon (38-liter) can, agitator, heat supply, and indicating thermometer from pasteurizer.
<b>Method</b>	<p>By measuring the time required for the reading of the thermometer being tested to increase 12°F (7°C) through a specified temperature range. (<i>Temperature range must include pasteurization temperature.</i>)</p> <p>The temperature used in the water or oil bath will depend upon the scale range of the thermometer to be tested.</p>
<b>Procedure</b>	Table 6-11 lists the steps for testing the thermometric response of indicating thermometers.

**ATTENTION** To ensure that the hot water bath does not cool significantly, no more than 15 seconds should elapse between the end of Step 1 and the beginning of Step 3.

Table 6-11 Thermometric Response Test for Indicating Thermometers

Step	Action
1	Immerse indicating thermometer in water or oil bath heated to a temperature at least 19°F (11°C) higher than minimum scale reading on the indicating thermometer. Bath temperature should be higher than maximum pasteurization temperature for which thermometer is used.
2	Immerse indicating thermometer sensor in bucket of cold water for several seconds to cool it.
<b>ATTENTION</b> Continuous agitation of water baths during the performance of Steps 3, 4, and 5 is required.	
3	<p>Insert indicating thermometer sensor in hot water or oil bath to proper bulb immersion depth.</p> <p>With the Digital Reference feature of the Truline Recorder, the lower display will indicate the temperature for the indicating thermometer.</p>

*Continued on next page*

## 6.9 Indicating Thermometers Thermometric Response – Test 7, PMO 2003, Continued

Procedure, continued

Table 6-11 Thermometric Response Test for Indicating Thermometers, continued

Step	Action
4	Start stopwatch when indicating thermometer reads 19°F (11°C) below bath temperature.
5	Stop stopwatch when indicating thermometer reads 7°F (4°C) below bath temperature.
6	<p>Record thermometric response time for office record.</p> <div style="border: 1px solid black; padding: 10px; margin: 10px 0;"> <p style="text-align: center;">EXAMPLE:</p> <p>For a thermometer used at pasteurization temperature setpoints of 161°F (71.7°C) and 166°F (74.4°C), a water bath at a temperature of 173°F (78.3°C) could be used.</p> <ul style="list-style-type: none"> <li>• A temperature 19°F (10.6°C) lower than a 173°F (78.3°C) water bath would be <b>154°F (67.8°C)</b>.</li> <li>• A temperature 7°F (3.9°C) lower than a 173°F (78.3°C) water bath would be <b>166°F (74.4°C)</b>.</li> </ul> <p>Therefore, after immersing the thermometer, which has been previously cooled, in the 173°F (78.3°C) bath, start the stopwatch when the thermometer reads 154°F (67.8°C) and stop it when it reads 166°F (74.3°C).</p> </div>

**ATTENTION** The test included the pasteurization temperature setpoints of 161°F (71.7°C) and 166°F (74.4°C). If the pasteurization temperature setpoints had been 161°F (71.7°C) and 175°F (79.4°C), it would not have been possible to include both setpoints within a 12°F (6.7°C) span. With these setpoints the test would have to be done separately for each setpoint.

### Corrective action

If the response time exceeds four seconds, replace or repair the thermometer sensor and repeat the test. If the indicating thermometer still exceeds the response time, the recorder/controller should be repaired.

## 6.10 Recorder/Controller Thermometric Response – Test 8, PMO 2003

---

<b>Application</b>	Applies to all recorder/controllers used in connection with continuous flow pasteurizers except those in which the flow diversion device is located at the end of the cooler section.
<b>Frequency</b>	Upon installation and at least once every three months thereafter.
<b>Criteria</b>	Five seconds, under specified conditions.
<b>Apparatus</b>	Previously tested indicating thermometer (on pasteurizers), stopwatch, water or oil bath (39 liters or 10 gallon milk can), agitator, and heat supply.
<b>Method</b>	Measure the time interval between the instant when the recording thermometer reads 12°F (7°C) below the cut-in temperature and the moment of cut-in by the controller. This measurement is made when the sensing element is immersed in rapidly agitated water or oil bath maintained at exactly 7°F (4°C) above the cut-in temperature.

---

*Continued on next page*

## 6.10 Recorder/Controller Thermometric Response – Test 8, PMO 2003, Continued

### Procedure

Table 6-12 lists the steps for testing the thermometric response of the recorder/controller.

Table 6-12 Thermometric Response Test

Step	Action
1	<p>Check and, if necessary, adjust the pen-arm setting of the recording thermometer in the proper reference to agree with the indicating thermometer reading at pasteurization temperature.</p> <p>To adjust the recorder, refer to the procedure in <i>Section 6.3 Calibration Test</i>.</p>
2	Use the cut-in temperature of the controller as determined in Step 1 of Table 6-9.
3	Remove the sensing element and allow to cool to room temperature.
4	While vigorously agitating bath to insure uniform temperature, heat water or oil bath to exactly 7°F (4°C) above the cut-in temperature.
5	<p>For the Truline Recorder, use the digital reading of the milk temperature for the thermometric response test.</p> <p>To call up the digital display for the milk temperature (Input 2), press the <b>LOWR DISP</b> key until you see:</p> <div style="display: flex; justify-content: space-around; align-items: center;"> <div style="text-align: center;"> <p><b>HTST</b></p> <p>Upper Display</p> <div style="border: 1px solid black; width: 60px; height: 15px; margin: 0 auto;"></div> <p style="margin: 0 10px;">← PV value</p> <p>Lower Display</p> <div style="border: 1px solid black; width: 60px; height: 15px; margin: 0 auto; text-align: center;">2 IN XXX.X</div> </div> <div style="text-align: center;"> <p><b>STLR</b></p> <p>Upper Display</p> <div style="border: 1px solid black; width: 60px; height: 15px; margin: 0 auto;"></div> <p style="margin: 0 10px;">← PV value of Input 1</p> <p>Lower Display</p> <div style="border: 1px solid black; width: 60px; height: 15px; margin: 0 auto;"></div> </div> </div> <p>If you are using digital reference, use both displays. The upper display will be the milk temperature and the lower display will be the digital reference temperature.</p>
6	Immerse the recorder/controller bulb in the bath. Continue agitation during steps 7 and 8 below.
7	Start stopwatch when the recording thermometer reaches a temperature of 12°F (7°C) below the cut-in temperature.
8	Stop stopwatch when the controller cuts in.
9	Record thermometric response time for office record.

### Corrective action

If the response exceeds five seconds, the recorder/controller should be repaired.

## 6.11 Locking and Sealing the Recorder

<b>Application</b>	Applies to all Truline Recorder/Controllers used in connection with continuous flow pasteurizers.
<b>Frequency</b>	Upon installation, every three months thereafter, and whenever a process value is changed.
<b>Criteria</b>	The process values are configured, locked with the values determined by tests in subsections 6.3 through 6.10 inclusive, and finally the locking mechanism is sealed by the regulatory official.
<b>Method</b>	<p>The regulatory official shall lock the process values programmed into the Recorder/Controllers by moving the configuration switch to the "ON" position, and sealing the chart plate via wire seal. A hole is provided in the mounting bracket and hold down bolt for the chart plate which permits sealing the plate.</p> <p>The regulatory official shall confirm that the process values cannot be changed by plant personnel without breaking the seal(s). Provisions are provided for sealing the milk flow transmitter and the flow alarms.</p>
<b>Procedure</b>	After all the parameters are configured, follow the procedure in Table 6-13 to set and secure the switch (S1).

Table 6-13 Setting the Lockout Switch

Step	Action
1	Open the chart plate and place the Lockout switch (S1) in the ON (locked) position. (See Figure 2-3.)
2	Close the chart plate and secure the captive screw and bracket on the chart plate with a wire and lead seal. (See Figure 6-2.)

*Continued on next page*



# 6.11 Locking and Sealing the Recorder, Continued

Procedure, continued

Figure 6-2 DR45AH/DR45AS Recorder with Pasteurization Control

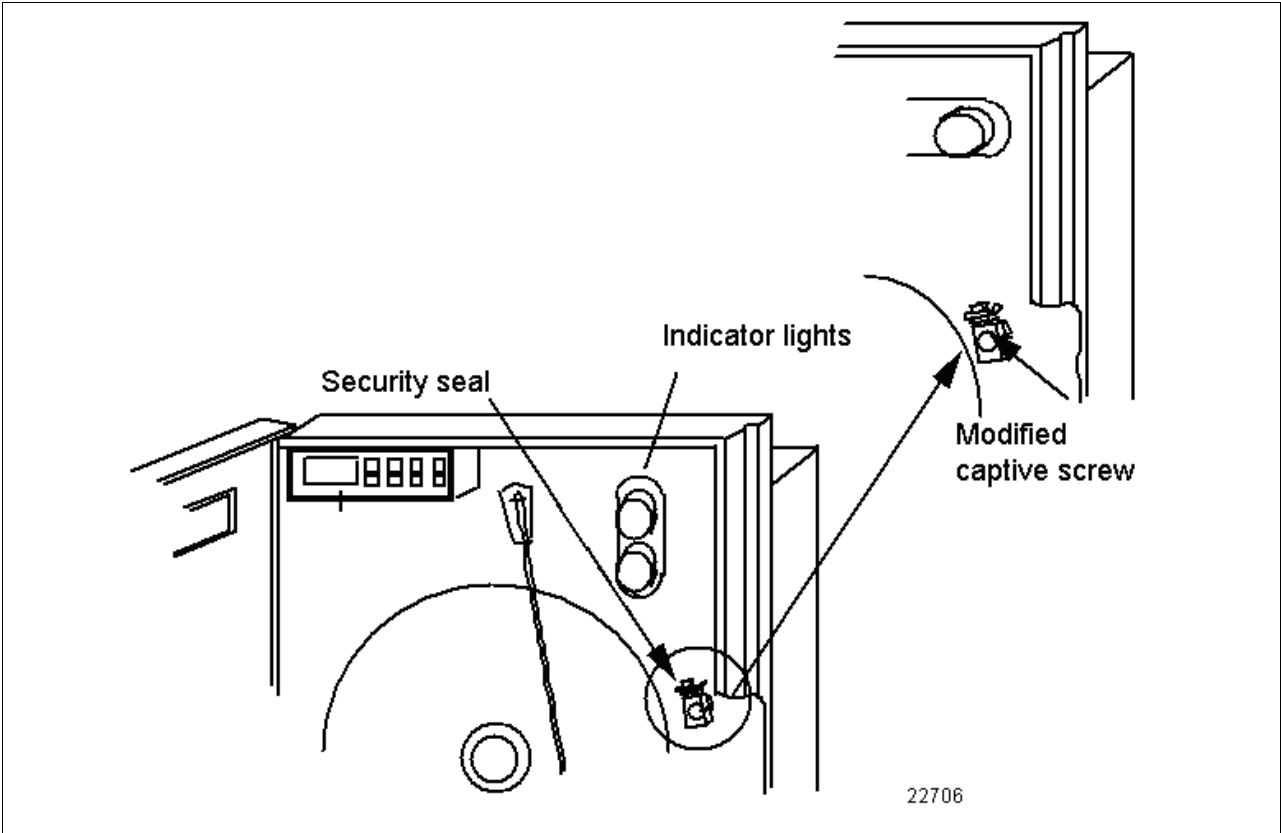

*Continued on next page*

## 6.11 Locking and Sealing the Recorder, Continued

**Process value check** After all tests are satisfactorily completed and the seals placed in position as indicated on the previous page, the following process values shall be checked and attempts made to change them with the raise or lower keys.

Check the following configuration:

Chart configuration - Table 6-14

Pen Configuration - Table 6-15

Diversion Temperature Setpoint - Table 6-16

**Chart configuration** Follow the procedure in Table 6-14 to check the chart configuration.

Table 6-14 Chart Configuration

Step	Operation	Press	Result
1	Select "Chart" Set up group	<b>SET UP</b>	until you see: Upper Display <b>SET UP</b> Lower Display <b>CHART</b>
2	Check chart speed	<b>FUNC</b>	until you see: Upper Display <b>XHR</b> Lower Display <b>CHRTSPD</b> The upper display should read "XHR".
3	Check hours per revolution	<b>FUNC</b>	until you see: Upper Display <b>12HR</b> Lower Display <b>HOUR/REV</b> The upper display should read "12HR".
4	Check the time division	<b>FUNC</b>	until you see: Upper Display <b>12</b> Lower Display <b>TIME DIV</b> The upper display should read "12".

*Table continued on next page*

## 6.11 Locking and Sealing the Recorder, Continued

### Chart configuration check, continued

Table 6-14 Chart Configuration, continued

Step	Operation	Press	Result
5	Check continue chart rotation	<b>FUNC</b>	<p>until you see:</p> <p>Upper Display NO</p> <p>Lower Display CONTINUE</p> <p>The upper display should read "NO".</p>
6	Check Optional Chart Name	<b>FUNC</b>	<p>until you see:</p> <p>Upper Display (chart name)</p> <p>Lower Display CHARTNAM</p> <p>You can ignore this, since no header is to be used.</p>
7	Check Chart Header	<b>FUNC</b>	<p>until you see:</p> <p>Upper Display NO</p> <p>Lower Display HEADER</p> <p>The upper display should read "NO".</p>
8	Check Remote Chart Activation	<b>FUNC</b>	<p>until you see:</p> <p>Upper Display NONE</p> <p>Lower Display REM CHRT</p> <p>The upper display should read "NONE".</p>

*Continued on next page*

## 6.11 Locking and Sealing the Recorder, Continued

### Pen configuration check

Follow the procedure in Table 6-15 to check the pen configuration.

Table 6-15 Pen Configuration

Step	Operation	Press	Result
1	Select "PEN" Set up group	<b>SET UP</b>	until you see: Upper Display <b>SET UP</b> Lower Display <b>PEN</b>
2	Check that "PEN 2" is enabled	<b>FUNC</b>	until you see: Upper Display <b>ENABLE</b> Lower Display <b>PEN 2</b> The upper display should read "ENABLE".
3	Check input for pen 2	<b>FUNC</b>	until you see: Upper Display <b>INPUT 2</b> Lower Display <b>PEN 2IN</b> The upper display should read "INPUT 2".
4	Check chart high value	<b>FUNC</b>	until you see: Upper Display <b>210</b> Lower Display <b>CHART2 HI</b> The upper display should read "210".
5	Check chart low value	<b>FUNC</b>	until you see: Upper Display <b>140</b> Lower Display <b>CHART2 LO</b> The upper display should read "140".

*Continued on next page*

## 6.11 Locking and Sealing the Recorder, Continued

**Diversion temperature setpoints check** Follow the procedure in Table 6-16 to check the Diversion temperature setpoints.

Table 6-16 Diversion Temperature Setpoints Check

Step	Operation	Press	Result
1	Check diversion temperature 2nd setpoint	<b>LOWR DISP</b>	<p>until you see:</p> <p>Upper Display CHN 2 XX.X</p> <p>Lower Display 2SP XX.X</p> <p>This is the diversion temperature setpoint. Check that the value is as determined in the Cut-in/Cut-out temperature test in subsection 6-8.</p>
2	Check the Control Point Hysteresis	<b>SET UP</b>	<p>until you see:</p> <p>Upper Display SET UP</p> <p>Lower Display CONTROL 2</p>
		<b>FUNC</b>	<p>Upper Display 0.1</p> <p>Lower Display OUT HYST</p> <p>This is the control point hysteresis in percent of span. It should read "0.1". This value provides a temperature deadband between the forward and divert actuation. The hysteresis is all on the upper side of the setpoint.</p> <p>For example: If the diversion setpoint is set for 166°F, forward flow will not start until 166.5°F is reached. Divert flow will start at 166°F.</p> <p>This value is adjustable and can be changed as desired when configuring the recorder.</p>
3			Record the values in this test for the office record.

# Section 7 – Tests and Procedures for Model DR45AP - Pasteurization (Flow)

## 7.1 Overview

### Introduction

This section contains tests and procedures which should be done:

- prior to putting the Recorder/Controller into service
- any time a process value is changed
- at regular intervals (every three months is recommended).

The tests and procedures should be done in the order listed below:

- Configuration check or changes
- Magnetic Flowmeter Systems, Continuous Flow, Holding Time
- Continuous Flow Holders - Flow Alarms
- Continuous Flow Holders - Loss of Signal Alarm
- Continuous Flow Holders - Flow Cut-in and Cut-out
- Continuous Flow Holders - Time Delay Relay
- Differential Pressure Test
- Locking and Sealing Instrument and Sensor

### What's in this section

This section contains the following information:

	Topic	See Page
7.1	Overview	101
7.2	Configuration Check or Reconfiguration	102
7.3	Magnetic Flowmeter Systems, Continuous Flow, Holding Time Test – Test 11, PMO 2003	107
7.4	Continuous Flow Holders – Flow Alarm Test – Test 11-2B, PMO 2003	111
7.5	Continuous Flow Holders – Loss of Signal Alarm Test – Test 11-2C, PMO 2003	113
7.6	Continuous Flow Holders – Flow Cut-in and Cut-out Test – Test 11-2D, PMO 2003	115
7.7	Continuous Flow Holders – Time Delay Relay Test – Test 11-2E, PMO 2003	117
7.8	Differential Pressure Test – Test 9-4, PMO 2003	119
7.9	Locking and Sealing Instrument and Sensor	121

## 7.2 Configuration Check or Reconfiguration

---

<b>Application</b>	Applies to all Truline Recorder/Controllers used for a flow meter based timing system for Flow pasteurizers.
<b>Frequency</b>	Upon installation and whenever a configured value is changed.
<b>Criteria</b>	A set of FLOW configured values will be automatically entered in the Recorder/Controller when Step 5 in Table 7-1 is performed. Some of these values will have to be changed when the Recorder/Controller is used for flow recording and diversion.
<b>Apparatus</b>	None
<b>Method</b>	<p>The regulating official shall scan through the configuration prompts and the associated values after performing the steps under the Automatic Flow Configuration procedure (Table 7-1) and reset any value required (Table 7-2). The default values are found in Section 5 of this addendum (Flow Setting).</p> <p>The procedure for reconfiguring the values is listed in Subsection 3.5 of the Product Manual, 44-45-25-30, supplied with each Recorder/Controller.</p>
<b>Start Up</b>	<p>When power is applied to the recorder, it will run through a self-test program which will take approximately 10 seconds. During this test period, there are no control signals from the recorder/controller to the process.</p> <p>The flow diversion valve will remain in the divert position.</p> <p>At the end of this test, the digital display in the upper left corner of the case will indicate "TEST DONE".</p> <p>The display will then start reading the No. 1 input value in the upper display and the setpoint value in the lower display:</p>

---

Upper Display  
CHN 1 XX.X

Lower Display  
SP XX.X

*Continued on next page*











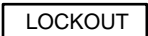

## 7.2 Configuration Check or Reconfiguration, Continued

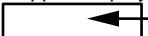
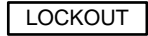
### Flow automatic configuration

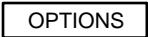
Follow the procedure in Table 7-1 to allow the FLOW configuration values to be automatically entered into memory.

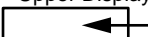
Open the door of the recorder, open the chart plate and place the switch (S1) on the Main processor board in the OFF position.

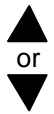
Table 7-1 Automatic Flow Configuration

Step	Operation	Press	Result
1	Set "LOCKOUT"		until you see: Upper Display  Lower Display 
2	Select "NONE"		until you see: Upper Display  NONE CALIB +CONF +VIEW MAX Lower Display  Press the ▲ or ▼ keys to select NONE
3	Select "OPTIONS" Set Up mode		until you see: Upper Display  Lower Display 
5	Select FLOW		until you see: Upper Display  NONE HTST STLR FLOW Lower Display  Press the ▲ or ▼ keys
			to select FLOW.
6	Automatic entry		and the <b>FLOW</b> configuration values are entered as listed in <i>Section 5 (Flow Setting)</i> in this addendum.

*Continued on next page*



## 7.2 Configuration Check or Reconfiguration, Continued

### Flow automatic configuration, continued

The other configuration values on the recorder will have automatically been entered when the FLOW option was selected. They should be reviewed to determine that they are correct for each application. This can be done by pressing the **SET UP** key to get to a group function as indicated in the lower display and then use the **FUNC** key to check each value setting within that group.

After selecting the FLOW option, any of the configuration values may be changed. Refer to Table 7-2 for the procedure.

### Reconfiguration

If any of the configuration values that were entered when FLOW option was selected need to be changed, follow the procedure in Table 7-2.

Open the door of the recorder, open the chart plate and place the switch (S1) on the Main processor board in the OFF position.

Table 7-2 Reconfiguration









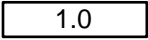

Step	Operation	Press	Result
1	Set "LOCKOUT"	<b>SET UP</b>	until you see: Upper Display <b>SET UP</b> Lower Display <b>LOCKOUT</b>
2	Select "NONE"	<b>FUNC</b>	until you see: Upper Display <b>NONE</b> CALIB Lower Display <b>LOCKOUT</b> +CONF +VIEW MAX Press the ▲ or ▼ keys to select NONE
3	Select Set Up mode	<b>SET UP</b>	until you see: Upper Display <b>SET UP</b> Lower Display <b>TUNING 1</b> Lets you know you are in the configuration mode and a Set Up group title is being displayed in the lower display. This is the first Set Up group title.

Table continued on next page

## 7.2 Configuration Check or Reconfiguration, Continued

### Reconfiguration, continued

Table 7-2 Reconfiguration, continued

Step	Operation	Press	Result
4	Select any Set Up group		<ul style="list-style-type: none"> <li>• Successive presses of the <b>SET UP</b> key will sequentially display the other Set Up group titles.</li> <li>• You can also use the <b>[▲]</b> <b>[▼]</b> keys to scan the Set Up groups in both directions.</li> <li>• Stop at the Set Up group title which describes the group of parameters you want to reconfigure. Then proceed to the next step.</li> </ul>
5	Select a Function Parameter		<p>Upper Display   Shows the current value or selection for the first function prompt of the particular Set Up group that you have selected.</p> <p>Lower Display   ← PROP BAND or GAIN depending on what is selected in Set Up group "Control." Shows the first function prompt within that Set Up group.</p> <p>Example displays show Set Up group "Tuning", function prompt "Prop Band or Gain" and the value selected.</p>
6	Select other Function Parameters		<ul style="list-style-type: none"> <li>• Successive presses of the <b>FUNC</b> key will sequentially display the other function prompts of the Set Up group you have selected.</li> <li>• Stop at the function prompt that you want to change, then proceed to the next step.</li> </ul>
7	Change the value or selection	 or 	<ul style="list-style-type: none"> <li>• These keys increment or decrement the value or selection that appears for the function prompt you have selected.</li> <li>• Change the value or selection to meet your needs.</li> <li>• If the display flashes, you are trying to make an unacceptable entry.</li> </ul>
8	Enter the value or selection	 or 	<ul style="list-style-type: none"> <li>• This key selects another function prompt.</li> <li>• This key selects another Set Up group.</li> </ul> <p>The value or selection you have made will be entered into memory after another key is pressed.</p>
9	Exit Configuration		<p>This exits configuration mode and returns the recorder to the same state it was in immediately preceding entry into the Set Up mode. It stores any changes you have made.</p>

*Continued on next page*

## 7.2 Configuration Check or Reconfiguration, continued

### No communications option

The Communications Option will not be offered in this model. Confirm that Communications is not in the recorder.

- Open the door, unscrew the hold down screw for the chart plate and open it.
- Check that the communications card is not in the recorder. See Figure 7-1 for card location.

Figure 7-1 Communications Card Location

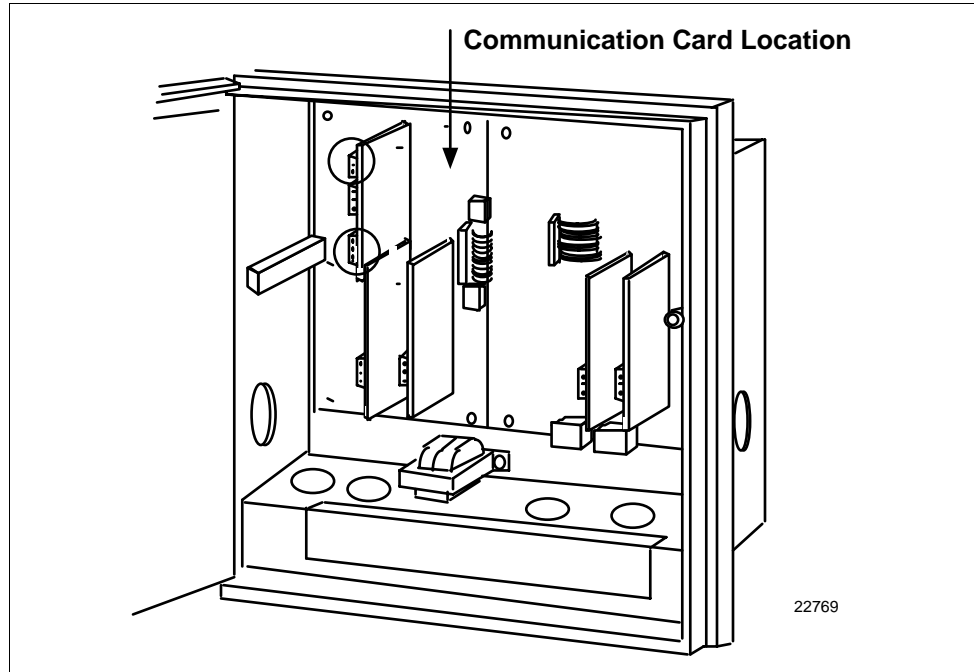

### Auto/Manual keys

The functions of the Auto/Manual keys are limited to the Flow recorder. These keys will not affect the high flow or low flow diversion setpoint or the flow event marking.

They cannot operate the flow diversion valve.

### Technical assistance

If the configuration values cannot be set or changed as described in this subsection or for other problems, contact the Honeywell Technical Assistance Center:

**1-800-423-9883**

### 7.3 Magnetic Flowmeter Systems, Continuous Flow, Holding Time Test – Test 11, PMO 2003

---

<b>Application</b>	To all high temperature short-time pasteurizers with holding time of 15 seconds or longer.
<b>Frequency</b>	Upon installation and every 6 months thereafter, whenever the seal on the speed setting is broken, any alteration is made affecting the holding time, the velocity of flow or the capacity of holding tube; or whenever a check of the capacity indicates a speed up.
<b>Criteria</b>	Every particle of milk shall be held for at least 15 seconds in both the forward and diverted flow positions.
<b>Apparatus</b>	Electrical conductivity measuring device, capable of detecting change in conductivity, equipped with standard electrodes; table salt (sodium chloride), a 50m/syringe; stopwatch; suitable container for salt solution.
<b>Method</b>	The holding time is determined by timing the interval for an added trace substance to pass through the holder. Although the time interval of the fastest particle of milk is desired, the conductivity test is made with water. The results found with water are converted to the milk flow time, by formulation, since a pump may not deliver the same amount of milk as it does water.

---

*Continued on next page*

## 7.3 Magnetic Flowmeter Systems, Continuous Flow, Holding Time Test – Test 11, PMO 2003, Continued

### Procedure

Table 7-3 lists the steps to run the Continuous Flow, Holding Time test.

Table 7-3 Continuous Flow, Holding Time Test

Step	Action
1	<p>Examine the entire system to insure that all flow promoting equipment is operating at maximum capacity and all flow impeding equipment is so adjusted or bypassed as to provide the minimum resistance to the flow. There shall be no leakage on the suction side of the timing pump.</p>
2	<p>Adjust the setpoint on the Flow Alarm to its highest possible setting.</p> <p>Press the <b>SET UP</b> key until you see:</p> <div style="text-align: center;"> <p>Upper Display</p> <div style="border: 1px solid black; padding: 2px; display: inline-block;">SET UP</div> </div> <div style="text-align: center;"> <p>Lower Display</p> <div style="border: 1px solid black; padding: 2px; display: inline-block;">OPTIONS</div> </div> <p>Press the <b>FUNC</b> key until you see:</p> <div style="text-align: center;"> <p>Upper Display</p> <div style="border: 1px solid black; padding: 2px; display: inline-block;"> <span style="font-size: 2em;">←</span> </div> <p>High Flow Limit Value</p> <p>Lower Display</p> <div style="border: 1px solid black; padding: 2px; display: inline-block;">HI FLOW</div> </div> <p>Press the ▲ or ▼ keys to select the “highest possible setting”</p>
3	<p>Adjust the setpoint on the recorder to a flow rate estimated to yield an acceptable holding time.</p> <p>Press the <b>LOWR DISP</b> key until you see:</p> <div style="text-align: center;"> <p>Upper Display</p> <div style="border: 1px solid black; padding: 2px; display: inline-block;"> <span style="font-size: 2em;">←</span> </div> <p>The PV value</p> <p>Lower Display</p> <div style="border: 1px solid black; padding: 2px; display: inline-block;"> <span style="font-size: 2em;">←</span> </div> <p>SP and the local setpoint value</p> </div> <p>Press the ▲ or ▼ keys to select the flow rate estimated to yield an acceptable holding time.</p>
4	<p>Install one electrode at the inlet to the holder and other electrode at the holder outlet. Close the circuit to the electrode located at the inlet to the holder.</p>

*Table continued on next page*

## 7.3 Magnetic Flowmeter Systems, Continuous Flow, Holding Time Test – Test 11, PMO 2003, Continued

Procedure, continued

Table 7-3 Continuous Flow, Holding Time Test, continued

Step	Action
5	Operate the pasteurizer using water at pasteurization temperature, with the flow diversion device in the forward flow position.
6	Quickly inject 50-ml of saturated sodium chloride solution into the holder inlet.
7	Start the stopwatch with the first movement of the indicator of a change in conductivity. Open the circuit to the inlet electrode and close the circuit to the electrode at the outlet of the holder.
8	Stop the stopwatch with the first movement of the indicator of a change in conductivity.
9	Record the results.
10	Repeat the test six or more times, until six successive results are within 0.5 seconds of each other. The average of these six tests is the holding time for water in forward flow. When consistent readings cannot be obtained, purge the equipment, check instruments and connections, and check for air leakage on suction side of the pump located at the raw product supply tank. Repeat tests. If six consecutive readings within 0.5 seconds cannot be achieved in forward and diverted flow, the pasteurizing system needs to be repaired.
11	Repeat Steps 5 through 10 for testing time on water in diverted flow.
12	With the Flow Controller at the same setpoint as in Step 3, time the filling of a 38 liter (10-gallon) can with a measured weight of water using the discharge outlet with the same head pressure as in normal operation. Average the time of several trials. [Since flow rates of the large capacity units make it very difficult to check by filling a 38 liter (10-gallon) can, it is suggested that a calibrated tank of considerable size be used.]
13	Repeat Step 12 using milk.

*Table continued on next page*

## 7.3 Magnetic Flowmeter Systems, Continuous Flow, Holding Time Test – Test 11, PMO 2003, Continued

Procedure, continued

Table 7-3 Continuous Flow, Holding Time Test, continued

Step	Action
14	<p>Compute the holding time for milk from the following formula by <i>weight</i>, using the average specific gravity.</p> <p>Compute separately for forward flow and diverted flow.</p> <p>Holding time for milk = <math>1.032 (TM_w)/W_w</math> (by weight), in which</p> <p>1.032 = specific gravity for milk;            T = average holding time for water;            M<sub>w</sub> = average time required to deliver a measured weight of milk;            W<sub>w</sub> = average time required to deliver an equal weight of water.</p> <p>The holding time for milk may also be computed from the following formula by <i>volume</i>.</p> <p>Compute separately for forward flow and diverted flow.</p> <p>Holding time for milk = <math>T (M_v/W_w)</math> (by volume), in which</p> <p>T = average holding time for water;            M<sub>v</sub> = average time required to deliver a measured volume of milk;            W<sub>w</sub> = average time required to deliver an equal volume of water.</p>
15	<p>With the Flow Controller at the same setpoint as in Step 3, record the flow rate from the recording chart for use in the following tests. Record this result along with the results of the salt timing tests for the office record.</p>

### Corrective action

When the computed holding time for milk is less than that required either in forward flow or diverted flow, the setpoint on the Flow Recorder/Controller shall be decreased, or adjustment made in the holding tube, and the timing repeated until satisfactory holding time is achieved. Should an orifice be used to correct the holding time in diverted flow, there should be no excessive pressure exerted on the underside of the valve seat of the flow diversion device.

## 7.4 Continuous Flow Holders – Flow Alarm Test – Test 11-2B, PMO 2003

---

<b>Application</b>	Applies to all high temperature short-time pasteurizers using a magnetic Flow Meter System to replace a metering pump.
<b>Frequency</b>	Upon installation and every 6 months thereafter, whenever a seal on the Flow Recorder/Controller is broken; any alteration is made affecting holding time, the velocity of the flow or capacity of holding tube, or whenever a check of the capacity indicates a speed up.
<b>Criteria</b>	When the flow rate equals or exceeds the value at which holding time was measured, the Flow Alarm shall cause the flow diversion device to assume the diverted position even though the temperature of the milk in the holding tube is above pasteurization temperatures.
<b>Apparatus</b>	None
<b>Method</b>	Adjust the setpoint of the HIGH FLOW LIMIT so that flow is diverted when the flow rate equals or exceeds the value at which holding time was measured.

---

*Continued on next page*



## 7.4 Continuous Flow Holders – Flow Alarm Test – Test 11-2B, PMO 2003, Continued

### Procedure

Table 7-4 lists the steps required to run the Continuous Flow, Flow Alarm test.

Table 7-4 Continuous Flow Holders, Flow Alarm Test

Step	Action
1	Operate the pasteurizer in forward flow, at the flow rate at which holding time was measured, using water above pasteurization temperature.
2	<p>Adjust the setpoint of the HIGH FLOW LIMIT downward until the frequency pen on the Recorder indicates that flow has been diverted.</p> <p>Press the <b>SET UP</b> key until you see:</p> <div style="text-align: center;"> <p>Upper Display</p> <div style="border: 1px solid black; padding: 2px; display: inline-block;">SET UP</div> <p>Lower Display</p> <div style="border: 1px solid black; padding: 2px; display: inline-block;">OPTIONS</div> </div> <p>Press the <b>FUNC</b> key until you see:</p> <div style="text-align: center;"> <p>Upper Display</p> <div style="border: 1px solid black; padding: 2px; display: inline-block;"> <span style="font-size: 2em;">←</span> </div> <p>Lower Display</p> <div style="border: 1px solid black; padding: 2px; display: inline-block;">HI FLOW</div> </div> <p style="margin-left: 150px;">High Flow Limit Value</p> <p>Press the <b>▲</b> or <b>▼</b> keys to adjust the High Flow Limit Value downward until the frequency pen on the recorder indicates that flow has been diverted.</p>
3	Observe that flow diversion device is moved to the diverted position while water, passing through the system, remains above pasteurization temperature.
4	Record the setpoint of the HIGH FLOW LIMIT, the occurrence of flow diversion and the temperature of water in the holding tube, for the office record.

### Corrective action

If the flow diversion device does not move to the diverted position when the frequency pen of the Recorder indicates a diversion, a modification or repair of the control wiring is required.

## 7.5 Continuous Flow Holders – Loss-of-Signal Alarm Test – Test 11-2C, PMO 2003

---

<b>Application</b>	Applies to all high temperature short-time pasteurizers using a Magnetic Flow Meter System to replace a metering pump.
<b>Frequency</b>	Upon installation and every 6 months thereafter, whenever seal on the Flow Recorder/Controller is broken; or any alteration is made affecting the holding time.
<b>Criteria</b>	Forward flow occurs only when flow rates are below the HI FLOW LIMIT setpoint and above the Loss-of-Signal Alarm/LOW FLOW LIMIT setpoint.
<b>Apparatus</b>	None
<b>Method</b>	By observing the recorder readings along with the action of the frequency pen on the recorder and the position of the flow diversion device.

---

*Continued on next page*

## 7.5 Continuous Flow Holders – Loss-of-Signal Alarm Test – Test 11-2C, PMO 2003, Continued

### Procedure

Table 7-5 lists the steps required to run the Continuous Flow, Loss-of-Signal Alarm test.

Table 7-5 Continuous Flow Holders, Loss-of-Signal Alarm Test

Step	Action
1	Operate pasteurizer in forward flow, at a flow rate below the HIGH FLOW LIMIT setpoint and above the Loss-of-Signal Alarm/LOW FLOW LIMIT setpoint, using water above pasteurization temperature.
2	<p>Change the Flow Rate Setpoint on the recorder. Decrease flow rate setpoint slowly until the frequency pen on the Recorder indicates a flow diversion (flow cut-out point). The flow diversion device will also assume the diverted position. Observe the reading of flow rate from the Recorder, the instant flow cut-out occurs, as indicated by the frequency pen.</p> <p>Press the <b>LOWR DISP</b> key until you see:</p> <div style="text-align: center;"> </div> <p>Press the ▲ or ▼ keys to adjust the flow rate.</p>
3	With the pasteurizer operating on water above the pasteurization temperature, with the flow diversion device diverted because of low flow rate, slowly increase flow rate until the frequency pen on the Flow Recorder indicates the start of a forward flow movement (flow cut-in point). Because of the time delay relay described in Subsection 6.7, the flow diversion device will not move immediately to the forward flow position. Observe the reading from the Recorder, the instant flow cut-in occurs, as indicated by the frequency pen.
4	Record results for the office record.

### Corrective action

If the cut-in or cut-out point occurs at a flow rate equal to or greater than the value at which holding time was measured, adjust the HIGH FLOW LIMIT to a lower setpoint, and repeat the test.

## 7.6 Cut-in and Cut-out Flow Points Test – Test 11-2D, PMO 2003

---

<b>Application</b>	Applies to all Truline Recorder/Controllers (Model DR45AP) used on continuous flow pasteurizers for flow control using a Magnetic Flow Meter System to replace a metering pump.
<b>Frequency</b>	Upon installation and every 6 months thereafter, whenever a seal on the Recorder/Controller is broken; any alteration is made affecting the holding time, the velocity of the flow or the capacity of the holding tube; or whenever a check of the capacity indicates a speed up.
<b>Criteria</b>	Forward flow cannot occur until a flow rate below the maximum and above the minimum has been reached. Diverted flow must occur when the flow exceeds the maximum flow rate or is below the low flow rate or "loss of signal" flow rate.
<b>Apparatus</b>	None
<b>Method</b>	By observing the Recorder readings along with the action of the frequency pen on the Flow Recorder/Controller.

---

*Continued on next page*

## 7.6 Cut-in and Cut-out Flow Points Test – Test 11-2D, PMO 1993, Continued

### Procedure

Note the flow rate setpoint on Channel 1 before starting the test so you can return to that setpoint upon completion of test. Table 7-6 lists the steps required to run the Cut-in/Cut-out Flow Points test.

Table 7-6 Cut-in and Cut-out Flow Points Test

Step	Action
1	Operate pasteurizer in forward flow, at a flow rate below the HIGH FLOW LIMIT setpoint and above the Loss-of-Signal/LOW FLOW LIMIT Alarm setpoint, using water above pasteurization temperature.
2	<p>Using the Flow Recorder/Controller, increase flow rate slowly until the divert lights on the Recorder (See figure 1-1) indicate a flow diversion (flow cut-out point).</p> <p>Press the <b>LOWR DISP</b> key until you see:</p> <div style="text-align: center;"> <p>Upper Display</p> <p><input type="text"/> ← The PV value</p> <p>Lower Display</p> <p><input type="text"/> ← SP and the local setpoint value</p> </div> <p>Press the <b>[▲]</b> <b>[▼]</b> keys to increase the flow rate setpoint slowly.</p> <p>The flow diversion device will also assume the diverted position. Observe the reading of flow rate value from the Recorder, the instant flow cut-out occurs, as indicated by the divert lights.</p> <p>The red light, located at the top of the recorder (See figure 1-1), indicates diverted flow.</p>
3	<p>With the pasteurization operating on water above the pasteurization temperature, with the flow diversion device diverted because of excessive flow rate, slowly decrease flow rate until the divert lights at the top of the Flow Recorder/Controller indicates the start of a forward flow movement (flow cut-in point).</p> <p>Press the <b>LOWR DISP</b> key until you see:</p> <div style="text-align: center;"> <p>Upper Display</p> <p><input type="text"/> ← The PV value</p> <p>Lower Display</p> <p><input type="text"/> ← SP and the local setpoint value</p> </div> <p>Press the <b>[▲]</b> <b>[▼]</b> keys to decrease the flow rate setpoint slowly.</p> <p>Because of the time delay relay described in the Test in Subsection 7.7, the flow diversion device will not move immediately to the forward flow position. Observe the reading from the Recorder, the instant flow cut-in occurs, as indicated by the recorder divert lights.</p> <p>The red light indicates diverted flow. The red light will turn off when the legal flow has been reached and the green light will turn on once the internal timer has timed out and the recorder changes the output to the diversion valve to cause forward flow.</p>
4	Record the results for the office record.

### Corrective action

If the cut-in or cut-out point occurs at a flow rate equal to or greater than the value at which holding time was measured, adjust the HIGH FLOW LIMIT to a lower setpoint, and repeat the test.

## 7.7 Time Delay Relay Test – Test 11-2E, PMO 2003

---

<b>Application</b>	Applies to all high temperature short-time pasteurizers using the Magnetic Flow Meter System to replace a metering pump.
<b>Frequency</b>	Upon installation and every 6 months thereafter, whenever seal on the Flow Recorder/Controller or time delay relay enclosure is broken; any alteration is made affecting the holding time, the velocity of the flow or the capacity of the holding tube; or whenever a check of the capacity indicates a speed up.
<b>Criteria</b>	Following a flow cut-in, as described in the test for flow cut-in and cut-out, forward flow shall not occur until all product in the holding tube has been held at or above pasteurization temperature for at least the minimum holding time.
<b>Apparatus</b>	Stopwatch
<b>Method</b>	Set time delay equal to or greater than the minimum holding time.

---

*Continued on next page*

## 7.7 Time Delay Relay Test – Test 11-2E, PMO 1993, Continued

### Procedure

Table 7-7 lists the steps required to run the Time Delay Relay test.

Table 7-7 Time Delay Relay Test

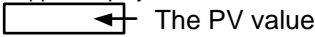
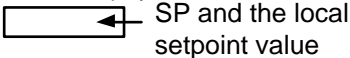
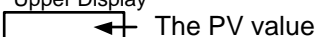
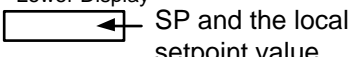
Step	Action
1	Operate pasteurizer in forward flow, at a flow rate below the HIGH FLOW LIMIT setpoint and above the Loss-of-Signal/LOW FLOW LIMIT Alarm setpoint, using water above pasteurization temperature.
2	<p>Using the Flow Recorder/Controller, increase flow rate slowly until the frequency pen on the Recorder indicates a flow diversion.</p> <p>Press the <b>LOWR DISP</b> key until you see:</p> <div style="text-align: center;"> <p>Upper Display</p>  <p>Lower Display</p>  </div> <p>Press the [<b>▲</b>] [<b>▼</b>] keys to increase the flow rate setpoint slowly.</p> <p>The flow diversion device will also assume the diverted position. There shall be no time delay between the divert lights changing from green to red and the flow diversion device.</p>
3	<p>With the pasteurization operating on water above the pasteurization temperature, with the flow diversion device diverted because of excessive flow rate, slowly decrease flow rate until the frequency pen on the Flow Recorder/Controller indicates the start of a forward flow movement.</p> <p>Press the <b>LOWR DISP</b> key until you see:</p> <div style="text-align: center;"> <p>Upper Display</p>  <p>Lower Display</p>  </div> <p>Press the [<b>▲</b>] [<b>▼</b>] keys to decrease the flow rate setpoint slowly.</p>
4	Start the stopwatch the instant the red light turns off on the Flow Recorder/Controller. This indicates the start of the internal timer that controls the output for the forward flow movement.
5	Stop the stopwatch the instant the green light turns on to indicate that the flow diversion device starts to move to the forward flow position.
6	<b>Record the results for the office record.</b>

### Corrective action

If the time delay is less than the minimum holding time, increase the time setting on the time delay and repeat this test procedure.

## 7.8 Differential Pressure Test – Test 9.4, PMO 2003

---

<b>Application</b>	Applies to all Truline Recorders/Controllers (Model DR45AP) used to control the operation of booster pumps on continuous flow pasteurizers for flow control with the Differential Pressure option displaying and recording the Raw and Pasteurized pressures in the system.
<b>Frequency</b>	Upon installation and every three months thereafter, whenever seal on the Flow Recorder/Controller is broken; or any alteration is made affecting the independent transmitters used in the measurement of differential pressure.
<b>Criteria</b>	<p>The booster pump shall not operate, or the pasteurizer shall not operate in forward flow, unless the product pressure in the pasteurized side of the regenerator is at least 6.9 kPa (1 psi) greater than the product pressure in the raw side of the regenerator.</p> <p>Control 2, relay 1 should deactivate and turn on the booster pump if the differential pressure falls below the low limit.</p> <p>Control 2, relay 2 should deactivate if the high pressure limit is exceeded.</p>
<b>Apparatus</b>	<p>An accurate pressure gauge with an accuracy greater than or equal to 1/2 of 1% of a 0-100 PSI scale.</p> <p>A pneumatic testing device that will provide two isolated sanitary pressure connections and a port for the test pressure gauge.</p>
<b>Method</b>	By observing the recorder displays and noting the action of the relays on Control 2 printed circuit board.

---

*Continued on next page*



## 7.8 Differential Pressure Test, Continued

### Procedure

Table 7-8 lists the steps required to run the Differential Pressure test.

Table 7-8 Differential Pressure Test

Step	Operation	Action
1	Check pressure readings at zero	Loosen the process connections and remove the pressure from Input 2 (Pasteurized Milk Pressure) and Input 3 (Raw Milk Pressure) sensors. The lower display will read 0-0.
	Corrective action	If the lower display does not read 0-0: <ul style="list-style-type: none"> <li>• Check the transmitter calibration. (See transmitter user manual.)</li> <li>• Check the recorder calibration. (See the recorder product manual.)</li> </ul>
2	Check the accuracy of both inputs	<ul style="list-style-type: none"> <li>• Remove both sensors and mount on a pneumatic testing device.</li> <li>• Orient the sensors the way they will be installed on the pasteurizer (horizontal or vertical).</li> <li>• Increase the pressure on both sensors to a level near the normal pasteurized pressure at the regenerator outlet.</li> <li>• Check to see that the differential pressure displays are within 1 PSI of the actual pressure.</li> </ul>
	Corrective action	If the displays are not within 1 PSI of actual pressure, recorder and/or transmitter calibration is required. (See the recorder product manual.)
3	Check the Booster pump relay	<ul style="list-style-type: none"> <li>• Locate <b>Control 2, Relay 1</b> in the recorder/controller (see Figure 4-1 in subsection 4.2 in this addendum).</li> <li>• Decrease the differential pressure slowly until it falls below the low DP limit. Listen for an audible click of the relay when it deactivates to turn on the booster pump. Make sure the relay deactivates at the “Low DP Limit Value”.</li> <li>• Increase the differential pressure slowly. The relay should activate when the differential pressure moves above the “Low DP Limit” value taking into consideration any “time delay” set.</li> </ul>
	Corrective action	Refer to Section 5 in this addendum and check the values of the following configured items. Reconfigure if necessary (Subsection 5.4). <i>Differential Pressure Low Limit</i> Set Up Group “OPTIONS” - Function Prompt “DP LOLIM” <i>Differential Pressure Low Limit Relay Delay</i> Set Up Group “OPTIONS” - Function Prompt “DP DELAY”
4	Check the High Pressure Limit output	<ul style="list-style-type: none"> <li>• Locate <b>Control 2, Relay 2</b> in the recorder/controller (see Figure 4-1 in subsection 4.2 in this addendum).</li> <li>• Increase the pressure slowly until it moves the value set for High Pressure Limit. Listen for an audible click of the relay when it deactivates and turns on whatever is wired as an indication.</li> </ul>
	Corrective action	Refer to Section 5 in this addendum and check the values of the following configured items. Reconfigure if necessary (Subsection 4.4). <i>High Pressure Limit</i> Set Up Group “OPTIONS” - Function Prompt “HP LIMIT”.

## 7.9 Locking and Sealing the Recorder

<b>Application</b>	Applies to all Truline Recorder/Controllers used in connection with continuous flow pasteurizers.
<b>Frequency</b>	Upon installation, every 3 months thereafter, and whenever a process value is changed.
<b>Criteria</b>	The process values are configured, locked with the values determined by tests in subsections 7.3 through 7.8 inclusive, and finally the locking mechanism is sealed by the regulatory official.
<b>Method</b>	<p>The regulatory official shall lock the process values programmed into the Recorder/Controllers by moving the configuration switch to the "ON" position, and sealing the chart plate via wire seal. A hole is provided in the mounting bracket and hold down bolt for the chart plate which permits sealing the plate.</p> <p>The regulatory official shall confirm that the process values cannot be changed by plant personnel without breaking the seal(s). Provisions are provided for sealing the milk flow transmitter and the flow alarms.</p>
<b>Procedure</b>	After all the parameters are configured, follow the procedure in Table 7-9 to set and secure the switch (S1).

Table 7-9 Setting the Lockout Switch

Step	Action
1	Open the chart plate and place the Lockout switch (S1) in the ON (locked) position. (See Figure 4-3.)
2	Close the chart plate and secure the captive screw and bracket on the chart plate with a wire and lead seal. (See Figure 7-2.)

*Continued on next page*

# 7.9 Locking and Sealing the Recorder, Continued

Procedure, continued

Figure 7-2 DR45AH/DR45AP/DR45AS Recorder with Pasteurization Control

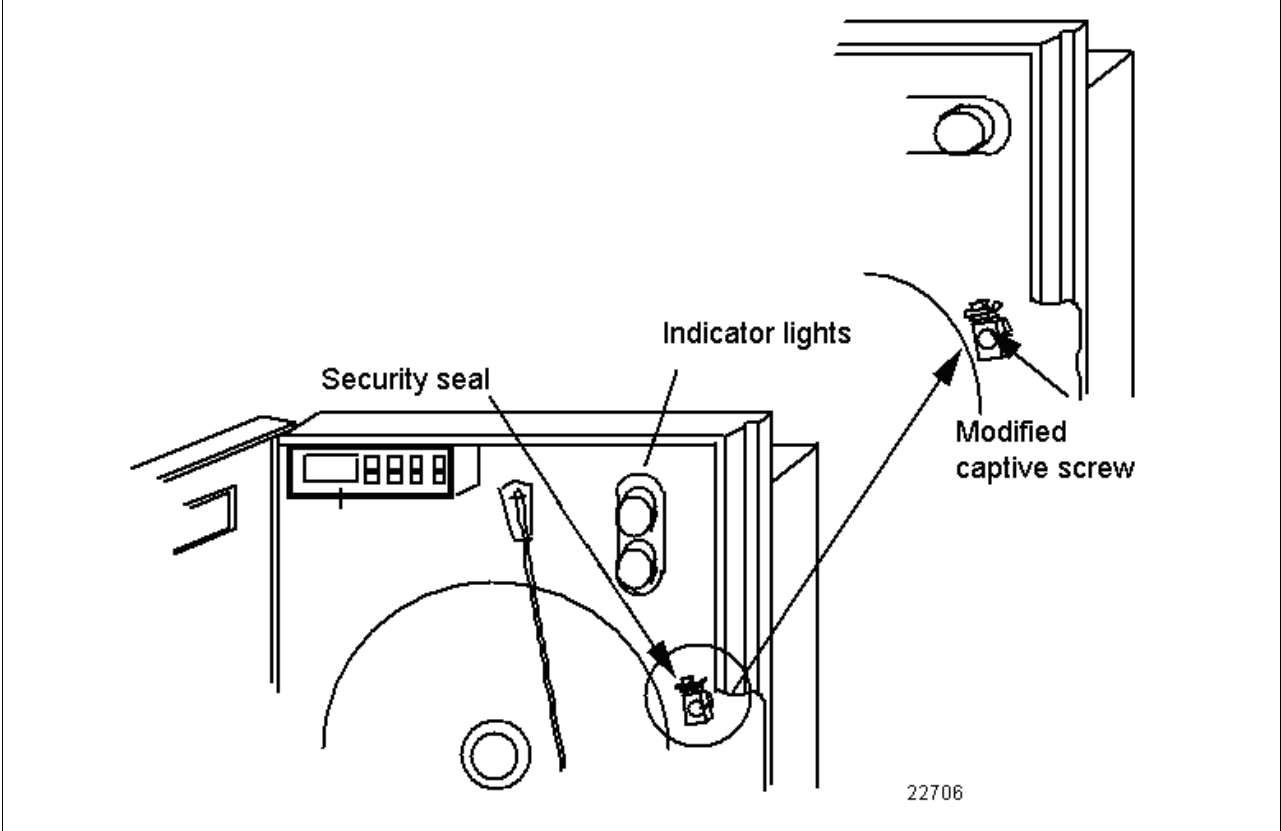

Continued on next page

## 7.9 Locking and Sealing the Recorder, Continued

**Process value check** After all tests are satisfactorily completed and the seals placed in position as indicated on the previous page, the following process values shall be checked and attempts made to change them with the raise or lower keys.

Check the following configuration:









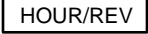





Chart Configuration - Table 7-10

Pen Configuration - Table 7-11

Flow Diversion Setpoint - Table 7-12

**Chart Configuration** Follow the procedure in Table 7-10 to check the chart configuration.

Table 7-10 Chart Configuration

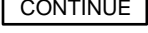
Step	Operation	Press	Result
1	Select "Chart" Set up group		until you see: Upper Display  Lower Display 
2	Check chart speed		until you see: Upper Display  Lower Display  The upper display should read "XHR".
3	Check hours per revolution		until you see: Upper Display  Lower Display  The upper display should read "12HR".
4	Check the time division		until you see: Upper Display  Lower Display  The upper display should read "12".
5	Check continue chart rotation		until you see: Upper Display  Lower Display  The upper display should read "NO".

*Table continued on next page*

## 7.9 Locking and Sealing the Recorder, Continued

### Chart configuration check, continued

Table 7-10 Chart Configuration, continued

Step	Operation	Press	Result
6	Check Optional Chart Name	<b>FUNC</b>	until you see: Upper Display <b>(chart name)</b> Lower Display <b>CHARTNAM</b> You can ignore this, since no header is to be used.
7	Check Chart Header	<b>FUNC</b>	until you see: Upper Display <b>NO</b> Lower Display <b>HEADER</b> The upper display should read "NO".

### Pen configuration check

Follow the procedure in Table 6-11 to check the pen configuration.

Table 7-11 Pen Configuration

Step	Operation	Press	Result
1	Select "PEN" Set up group	<b>SET UP</b>	until you see: Upper Display <b>SET UP</b> Lower Display <b>PEN</b>
2	Check that "PEN 2" is enabled	<b>FUNC</b>	until you see: Upper Display <b>ENABLE</b> Lower Display <b>PEN 2</b> The upper display should read "ENABLE".
3	Check input for pen 2	<b>FUNC</b>	until you see: Upper Display <b>INPUT 2</b> Lower Display <b>PEN 2IN</b> The upper display should read "INPUT 2".

*Table continued on next page*

## 7.9 Locking and Sealing the Recorder, Continued

### Pen configuration check, continued

Table 7-11 Pen Configuration, continued

Step	Operation	Press	Result
4	Check chart high value	<b>FUNC</b>	<p>until you see:</p> <p>Upper Display 50.0</p> <p>Lower Display CHART2 HI</p> <p>The upper display should read "50.0".</p>
5	Check chart low value	<b>FUNC</b>	<p>until you see:</p> <p>Upper Display 0.0</p> <p>Lower Display CHART2 LO</p> <p>The upper display should read "0.0".</p>

### Flow Diversion setpoints check

Follow the procedure in Table 7-12 to check the Flow Diversion setpoints.

Table 7-12 Flow Diversion Setpoints Check

Step	Operation	Press	Result
1	Check "LOW FLOW LIMIT" diversion setpoint	<b>LOWR DISP</b>	<p>until you see:</p> <p>Upper Display (pv value)</p> <p>Lower Display Flo XX.X</p> <p>This is the Loss-of-signal alarm/Low Flow Limit diversion setpoint. Check that the value is as determined in the Loss-of-Signal alarm test in subsection 7.5.</p>
2	Check "HIGH FLOW LIMIT" diversion setpoint	<b>LOWR DISP</b>	<p>until you see:</p> <p>Upper Display (pv value)</p> <p>Lower Display Fhi XX.X</p> <p>This is the High Flow Limit diversion setpoint. Check that the value is as determined in the Loss-of-Signal alarm test in Subsection 7.5. Record the values of these tests for the office record.</p>



## Section 8 – HTST Parts

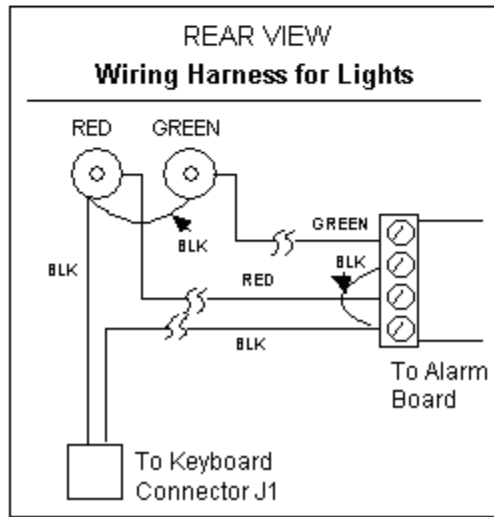
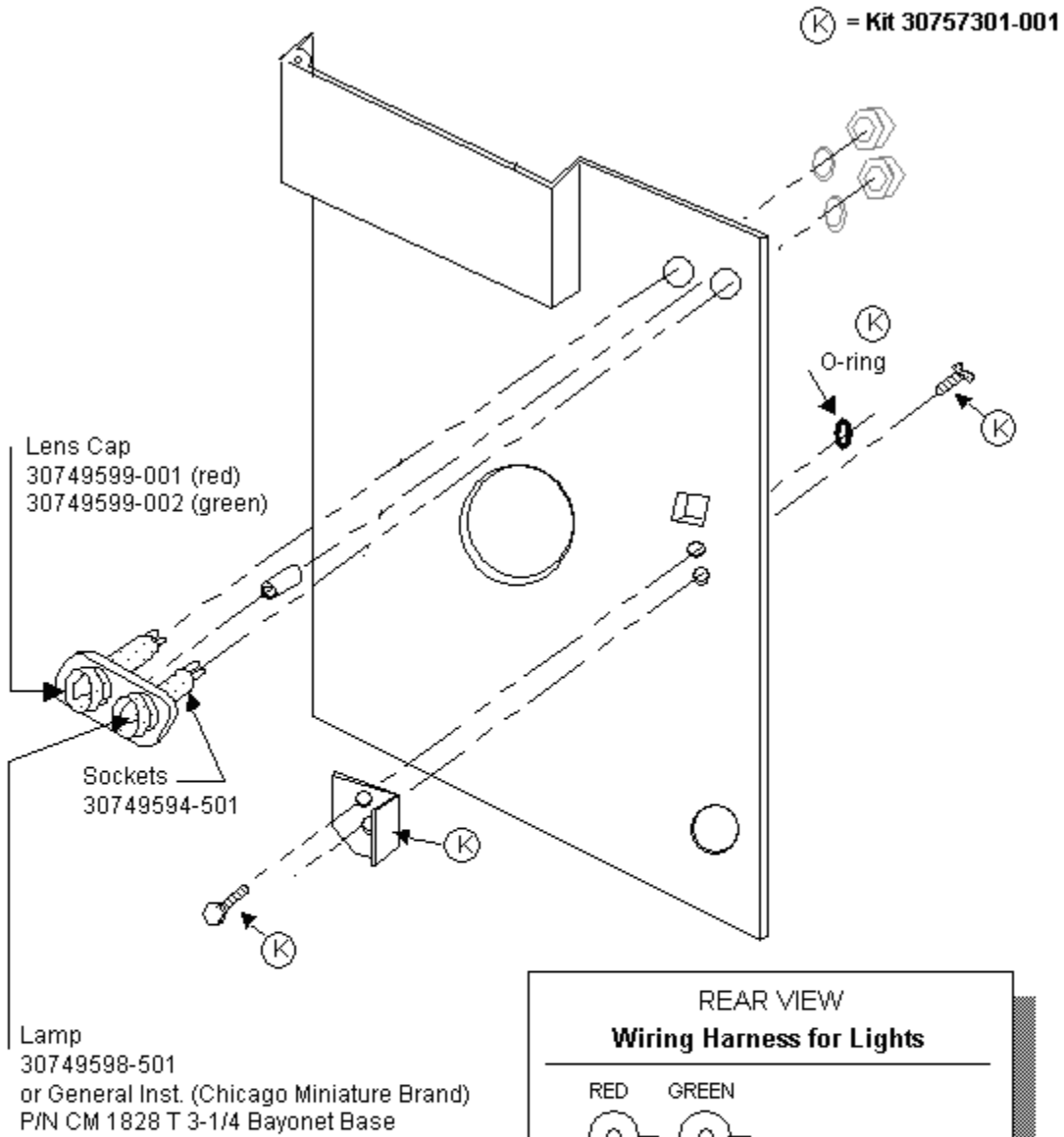



# Index

---

## A

- Adjust Printing Group, 71
- Automatic switchover value, 66, 68
- Auxiliary Output, 70
- Bias for remote setpoint, 66, 68
- Burnout, 62, 63, 64, 65
- Chart Group, 57
- Chart name, 57
- Chart speed selection, 57
- Component modification, 2
- Configuration, 14, 30, 44
- Configuration Lockout switch**, 1
- Configuration procedure, 16, 32
- configure the DR45AP, 46
- connection diagram for Model DR45AH, 13
- connection diagram for Model DR45AS, 29
- Control 1 Group, 66
- Control 2 Group, 68
- Control algorithm, 67, 69
- Control output direction, 66, 68
- Controller dropoff value, 66, 68
- Current/time duplex range, 67, 69
- Deadband, 67, 68
- Decimal point location, 62, 63, 64, 65
- Differential Pressure Function, 48
- DIFFERENTIAL PRESSURE FUNCTION, 5
- DIFFERENTIAL PRESSURE LO LIMIT function, 5
- Differential Pressure Low Limit Value, 48
- Digital reference temperature, 21, 37
- diversion setpoints, 11, 27
- Diversion switch relay, 9, 25
- Diversion Switch Relay**, 10, 26
- Diversion Valve Position Indication**, 1
- Divert relay valve, 9, 25
- Divert Valve Latch Relay and Socket**, 10, 26
- DP DELAY function, 5
- DP Time Delay, 48
- DR45AH Testing
  - Calibration test, 79
  - Check against indicating thermometers, 88
  - Configuration check or reconfiguration, 74
  - Locking and sealing the recorder, 95
  - Milk flow controls milk temperatures at cut-in and cut-out, 89
  - Recorder/controller thermometric response, 93
  - Temperature accuracy, 85
  - Time accuracy, 87
- DR45AP Testing
  - Configuration check or reconfiguration, 102
  - Cut-in and cut-out flow points test, 115
  - Differential pressure test, 119
  - Flow alarm test, 111
  - Holding time test, 107
  - Locking and sealing the recorder, 121
  - Loss-of-signal alarm test, 113
  - Time delay relay test, 117
- Electronics Access Control**, 1
- Failsafe output value, 67, 69
- field wiring, 8, 24, 40
- Filter, 62, 63, 64, 65
- Flow, 39
- Flow, 50
- FLOW, 5
- Flow diversion indication, 21, 37
- FLOW Operation, 50
- FORWARD DELAY function, 5
- Forward Delay Time Period, 47
- Gain units, 67, 69
- Header for chart, 57
- HI PRESSURE LIMIT function, 5
- High Flow Limit Value, 47
- High output limit, 66, 68
- High Pressure Limit Value, 48
- High setpoint limit, 66, 68
- HTST, 3, 7
- HTST control system, 9, 42
- HTST Operation, 18, 34
- Hysteresis, 67, 69
- Input 1 actuation type, 62, 63, 64, 65
- Input 1 Group, 62
- Input 2 Group, 63
- Input 3 Group, 64
- Input 4 Group, 65
- Input compensation, 62, 63, 64, 65
- Input versus Pen Assignment Model DR45AP, 45
- Input Versus Pen Assignments for Model DR45AH, 15
- Input Versus Pen Assignments for Model DR45AS, 31
- Low Flow Limit Value, 47
- Low output limit, 66, 68
- Low range value, 62, 63, 64, 65
- Low setpoint limit, 66, 68
- Milk Ordinance .c., 1
- Milk Pasteurization Process, 18, 34
- Model DR45AP - Pasteurization (Flow), 39
- Options Group, 70
- Output algorithm, 67, 69
- Output connections, 8, 24
- output connections for the DR45AP Model, 41
- Parameter Configuration Tables, 55
- Pasteurization, 23
- Pasteurization Selections, 3
- Pen 1 Group, 58
- Pen 2 Group, 59
- Pen 3 Group, 60
- Pen 4 Group, 61
- Power up controller mode recall, 66, 68
- Ratio for remote setpoint, 66, 68
- Rejection frequency, 70

# Index

---

Remote chart activation, 57  
Reset units, 67, 69  
S1 Lockout Switch, 14, 30  
Setpoint source, 66, 68  
Setpoint tracking, 66, 68  
Shed controller mode, 67, 69  
Shed setpoint recall, 67, 69  
Speed of response test, 22, 38  
STLR, 4  
STLR system, 25  
Temperature units, 62, 63, 64, 65  
Testing Procedures for Model DR45AH – HTST, 73  
Tests and Procedures for Model DR45AP -  
    Pasteurization (Flow), 101  
Transmitter characterization, 62, 63, 64, 65  
Tuning 1 Group, 55  
Tuning 2 Group, 56  
Tuning parameter sets, 66, 68



