

Level Measurement

Continuous level measurement – Radar transmitters

SITRANS LR560

Overview



SITRANS LR560 2-wire, 78 GHz FMCW radar level transmitter for continuous monitoring of solids in silos to a range of 100 m (329 ft).

Benefits

- Rugged stainless steel design for industrial applications
- 78 GHz high frequency provides very narrow beam, virtually no mounting nozzle noise, and optimal reflection from sloped solids
- Aimer option to direct beam to area of interest, such as draw point of cone
- Lens antenna is highly resistant to product build up
- Air purge connection is included for self-cleaning of extremely sticky solids
- Local display interface (LDI) allows local programming and diagnostics

Application

SITRANS LR560's plug and play performance is ideal for most solids applications, including those with extreme dust and high temperatures to 200 °C (392 °F). Unique design allows safe and simple programming using the Intrinsically Safe handheld programmer without having to open the instrument's lid. SITRANS LR560 includes an optional graphical local display interface (LDI) that improves setup and operation using an intuitive Quick Start Wizard, and echo profile display for diagnostic support. Startup is easy using the Quick Start wizard with a few parameters required for basic operation. SITRANS LR560 measures practically any solids material to a range of 100 m (328 ft).

- Key Applications: cement powder, plastic powder/pellets, grain, coal, wood powder, fly ash

Configuration

Installation

Note:

- Beam angle is the width of the cone where the energy density is half of the peak energy density
- The peak energy density is directly in front of and in line with the antenna
- There is signal transmitted outside of the beam angle; therefore false targets may be detected

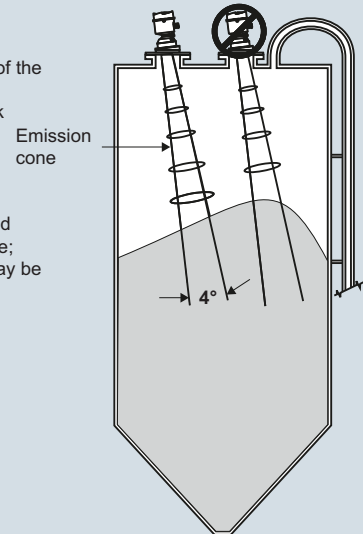

Aiming will assist in measuring material in the cone

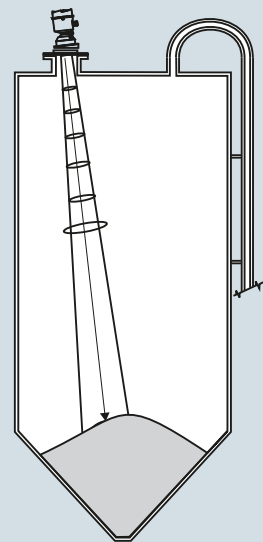

SITRANS LR560 installation, dimensions in mm (inch)

Level Measurement

Continuous level measurement – Radar transmitters

SITRANS LR560

Technical specifications

¹⁾ From sensor reference point

Mode of operation

Measuring principle	Radar level measurement
Frequency	78 GHz FMCW
Minimum detectable distance	400 mm (15.75 inch) from sensor reference point
Maximum measuring range ¹⁾	<ul style="list-style-type: none"> • 40 m (131 ft) version • 100 m (328 ft) version

Output

<ul style="list-style-type: none"> • Analog output • Communications 	4 ... 20 mA <ul style="list-style-type: none"> • HART • Optional: PROFIBUS PA • Optional: Foundation Fieldbus
<ul style="list-style-type: none"> • Fail-safe 	<ul style="list-style-type: none"> • Programmable as high, low or hold (Loss of Echo) • NE43 programmable

Performance (according to reference conditions IEC60770-1)

<ul style="list-style-type: none"> • Maximum measured error (including hysteresis and non-repeatability) 	<ul style="list-style-type: none"> • Greater of 25 mm (1 inch) or 0.25 % of range from minimum detectable distance to full range
-------------------------------------------------------------------------------------------------------------------------	-------------------------------------------------------------------------------------------------------------------------------------------------

Rated operating conditions (according to reference conditions IEC60770-1)

Installation conditions	Indoor/outdoor
<ul style="list-style-type: none"> • Location 	
Ambient conditions (enclosure)	
<ul style="list-style-type: none"> • ambient temperature • installation category • pollution degree 	-40 ... +80 °C (-40 ... +176 °F) I 4

Medium conditions

<ul style="list-style-type: none"> • Dielectric constant ϵ_r 	> 1.6
Process temperature and pressure	See chart below

Design

Enclosure	
<ul style="list-style-type: none"> • Construction • Conduit entry • Purge inlet • Lens material 	316L/1.4404 stainless steel M20x1.5, or 1/2" NPT via adapter 1/8" NPT, 30 cfm at max. 100 psi <ul style="list-style-type: none"> • 40 m version: PEI • 100 m version: PEEK Damage to lens could result from continuous purging/cleaning due to abrasive solids. Recommended purging/cleaning only a few seconds every hour Type 4X/NEMA 4X, Type 6/NEMA 6, IP68 with lid closed
<ul style="list-style-type: none"> • Degree of protection • Weight • Optional local display interface 	3.15 kg (6.94 lb) including 3 inch flange Graphic LCD, with bar graph representing level
Process connections	
Universal flat-faced flanges ²⁾	<ul style="list-style-type: none"> • 3, 4, 6 inch/80, 100, 150 mm, 304 stainless steel • 3, 4, 6 inch/80, 100, 150 mm, 316L/1.4404 or 316L/1.4435 stainless steel
AIMER flanges ²⁾	3, 4, 6 inch/80, 100, 150 mm, polyurethane powder-coated cast aluminum

Power supply

4 ... 20 mA/HART	Nominal 24 V DC (max. 30 V DC) with max. 550 Ω
PROFIBUS PA/ FOUNDATION Fieldbus	13.5 mA 9 ... 32 V DC, per IEC 61158-2

Certificates and approvals

General	CSA _{US/C} , CE, FM
Radio	Europe (R&TTE), FCC, Industry Canada, C-TICK
Hazardous	
<ul style="list-style-type: none"> • Europe/International 	IECEx SIR 09.0149X ATEX II 1D, 1/2D, 2D Ex ta IIC T139 °C Da IP68 ATEX II 3G Ex nA II T4 Gc Ex nL IIC T4 Gc
<ul style="list-style-type: none"> • US/Canada 	FM/CSA Class II, Div. 1, Groups E, F, G Class III T4 FM/CSA Class I, Div. 2, Groups A, B, C, D, T4 NEPSI Ex nA II T4 Ex nL IIC T4 DIP A20 TA, T139 °C, IP68 INMETRO BR-Ex nA/nL II T4 IP68
<ul style="list-style-type: none"> • China 	
<ul style="list-style-type: none"> • Brazil 	

Programming

Intrinsically Safe Siemens handheld programmer	Infrared receiver
<ul style="list-style-type: none"> • Approvals for handheld programmer 	IS model: ATEX II 1GD Ex ia IIC T4 Ga Ex iaD 20 T135 °C Ta = -20 ... +50 °C CSA/FM Class I, II, and III, Div. 1, Groups A, B, C, D, E, F, G, T6 Ta = 50 °C HART communicator 375/475 SIMATIC PDM, AMS, PACTware Graphic local user interface including quick start wizard and echo profile displays
Handheld communicator	
PC	
Display (local)	

²⁾ Universal flange mates with EN 1092-1 (PN 16)/ASME B16.5 (150 lb)/JIS 2220 (10K) bolt hole pattern.

Process temperature and pressure

Version	Stainless steel	AIMER flange: -1 to 0.5 bar	AIMER flange: -1 to 3.0 bar
40 m	-40 ... +100 °C (-40 ... +212 °F)	-40 ... +100 °C (-40 ... +212 °F)	-40 ... +100 °C (-40 ... +212 °F)
100 m	-40 ... +200 °C (-40 ... +392 °F)	-40 ... +200 °C (-40 ... +392 °F)	-40 ... +120 °C (-40 ... +248 °F)

Level Measurement

Continuous level measurement – Radar transmitters

SITRANS LR560

Selection and Ordering data	Article No.
SITRANS LR560	7ML5440-
2-wire, 78 GHz FMCW radar level transmitter for continuous monitoring of solids in silos to a range of 100 m (329 ft).	0 0 -
Order handheld programmer separately	
Measurement and process temperature range	
40 m (131 ft) max range, -40 ... +100 °C	0
100 m (329 ft) max range, -40 ... +200 °C	1
Process connection	
Universal flat-faced flange fits ANSI/DIN/JIS flanges	
3 inch/80 mm, 304 stainless steel	A
4 inch/100 mm, 304 stainless steel	B
6 inch/150 mm, 304 stainless steel	C
3 inch/80 mm, 316L stainless steel	D
4 inch/100 mm, 316L stainless steel	E
6 inch/150 mm, 316L stainless steel	F
3 inch/80 mm, painted aluminum, with integral aimer ¹⁾	G
4 inch/100 mm, painted aluminum, with integral aimer ¹⁾	H
6 inch/150 mm, painted aluminum, with integral aimer ¹⁾	J
Enclosure (with cable inlet)	
Stainless steel, 1 X 1/2" NPT	A
Stainless steel, 1 X M20 x 1.5 (plastic gland included)	B
Pressure rating	
0.5 bar g (7.5 psi g) maximum	0
3 bar g (40 psi g) maximum	1
Output/communication	
4 ... 20 mA, HART	A
PROFIBUS PA	B
Foundation Fieldbus	C
Approvals	
General Purpose, CSA _{US/IC} , Industry Canada, FCC, CE, R&TTE, C-TICK	A
CSA/FM Class I, Div. 2, Groups A, B, C, D, Class II, Div.1, Groups E, F, G, Class III	B
ATEX II 1 D, 1/2 D, 2 D, 3G Ex nA/nL, CE, R&TTE, C-TICK	C
Local display interface	
Without LDI (local display interface)	1
With LDI (local display interface)	2

¹⁾ Rated to 120 °C max. when used with Pressure rating option 1

◆ We can offer shorter delivery times for configurations designated with the Quick Ship Symbol ◆. For details see page 9/5 in the appendix.

Selection and Ordering data	Order code
Further designs	
Please add "-Z" to Article No. and specify Order code(s).	
Plug M12 with mating connector ¹⁾²⁾³⁾	◆ A50
Plug 7/8" with mating connector ¹⁾³⁾⁴⁾	◆ A55
Stainless steel tag [69 x 50 mm (2.71 x 1.97 inch)]: Measuring-point number/identification (max. 27 characters); specify in plain text	◆ Y15
Manufacturer's test certificate: M to DIN 55350, Part 18 and to ISO 9000	◆ C11
Inspection Certificate Type 3.1 per EN 10204 ⁴⁾	◆ C12
NAMUR NE43 compliant, device preset to failsafe < 3.6 mA ⁵⁾	◆ N07
Operating Instructions for HART device	Article No.
English	7ML1998-5KB02
German	7ML1998-5KB32
Multi-language Quick Start manual This device is shipped with the Siemens Milltronics manual DVD containing the ATEX Quick Start and Operating Instructions library.	A5E32052143
Operating Instructions for PROFIBUS PA device	
English	7ML1998-5LT02
German	7ML1998-5LT32
Multi-language Quick Start manual This device is shipped with the Siemens Milltronics manual DVD containing the ATEX Quick Start and Operating Instructions library.	A5E32043113
Operating Instructions for Foundation Fieldbus device	
English	7ML1998-5LY02
German	7ML1998-5LY32
Multi-language Quick Start manual This device is shipped with the Siemens Milltronics manual DVD containing the ATEX Quick Start and Operating Instructions library.	A5E32034712
Accessories	
Hand Programmer, Intrinsically safe	7ML1930-1BK
Local display interface	7ML1930-1FJ
Sun Shield Cover	7ML1930-1FK
Housing lid with window	7ML1930-1FL
One metallic cable gland M20x1.5, rated -40 ... +80 °C (-40 ... +176 °F), HART ⁶⁾	7ML1930-1AP
One metallic cable gland M20x1.5, rated -40 ... +80 °C (-40 ... +176 °F), PROFIBUS PA ⁶⁾	7ML1930-1AQ
SITRANS RD100 Remote display - see Chapter 7	
SITRANS RD200 Remote display - see Chapter 7	
SITRANS RD500 web, datalogging, alarming, ethernet, and modem support for instrumentation - see Chapter 7	7ML5750- 1AA00-0

¹⁾ Available with Approval option A only

²⁾ Available with Enclosure option B only

³⁾ Available with Output/communication options B and C only

⁴⁾ Available with Pressure rating option 1 only

⁵⁾ Available with Output/communication option A only

⁶⁾ Product shipped with plastic cable gland, rated to -20 °C.

If -40 °C rating required, then metallic cable gland is recommended.

◆ We can offer shorter delivery times for configurations designated with the Quick Ship Symbol ◆. For details see page 9/5 in the appendix.

Options

Handheld programmer

Part number:
7ML1930-1BK

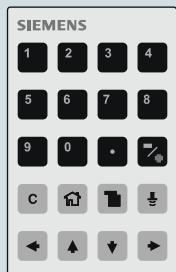

Sun shield cover

Part number:
7ML1930-1FK

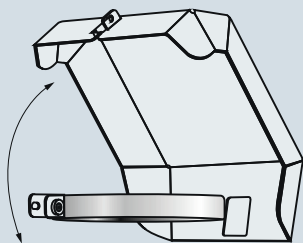

SITRANS LR560 handheld programmer and sun shield cover

Level Measurement

Continuous level measurement – Radar transmitters

SITRANS LR560

Characteristic curves

Temperature derating curve

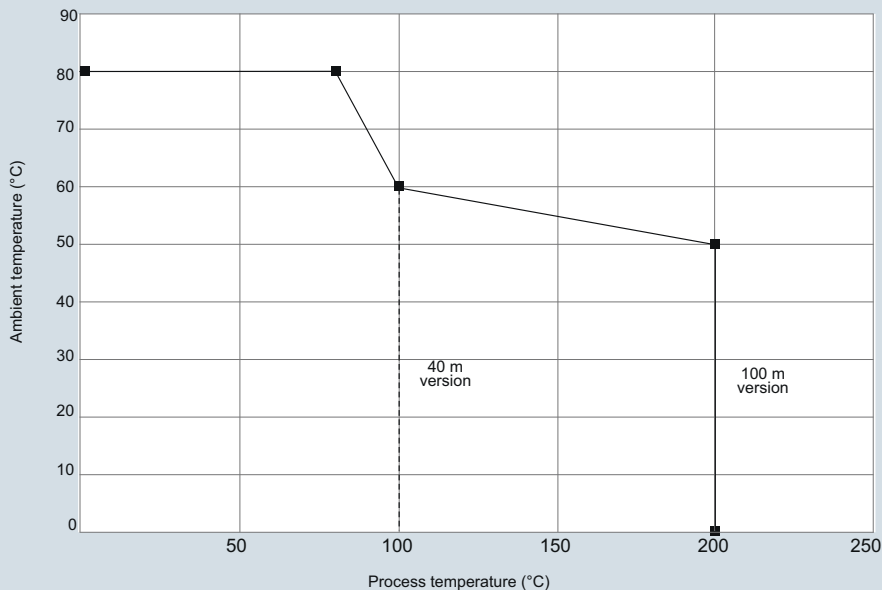
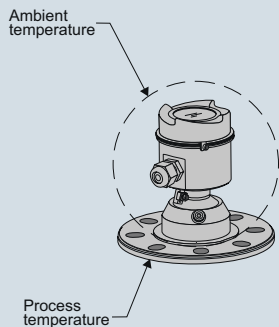

SITRANS LR560 temperature derating curve

Dimensional drawings

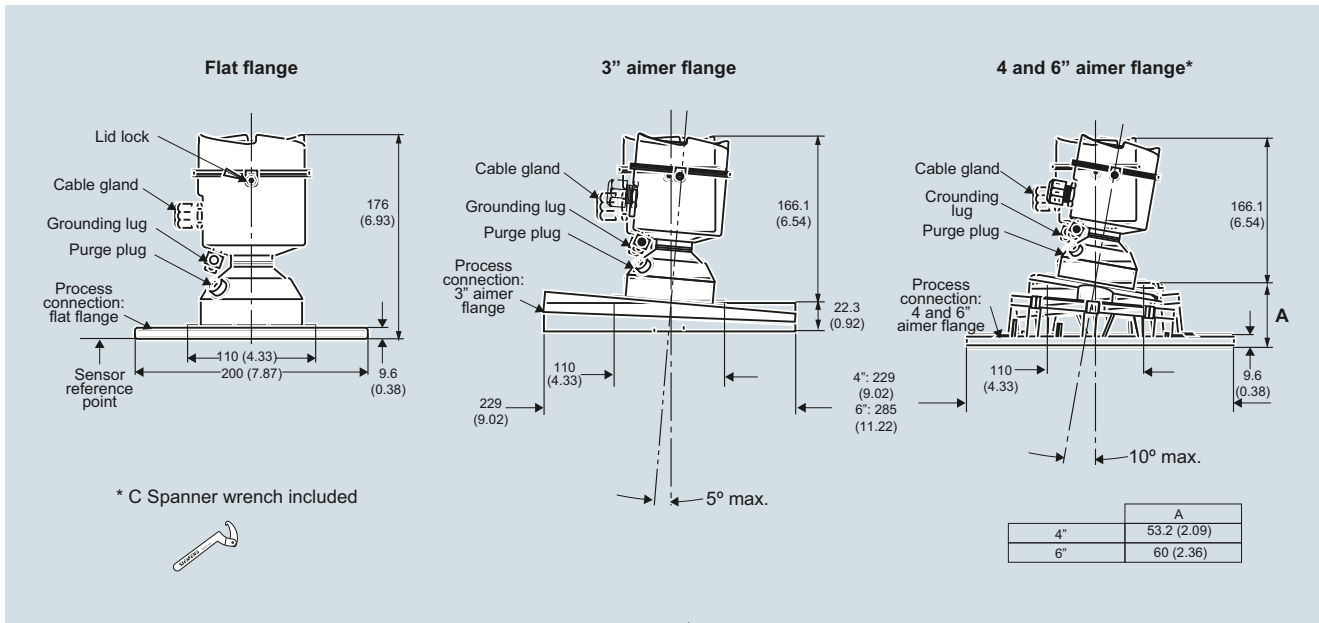

SITRANS LR560, dimensions in mm (inch)

4

Level Measurement

Continuous level measurement – Radar transmitters

SITRANS LR560 Specials

Schematics

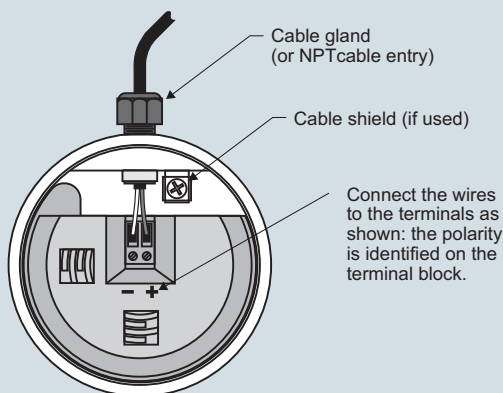

Notes:

1. Depending on the approval rating, glands and plugs may be supplied with your instrument.
2. DC terminal shall be supplied from a source providing electrical isolation between the input and output, to meet the applicable safety requirements of IEC 61010-1.
3. All field wiring must have insulation suitable for rated input voltages.
4. Use shielded twisted pair cable (14 to 22 AWG) for HART version.
5. Separate cables and conduit may be required to conform to standard instrumentation wiring practices or electrical codes.

SITRANS LR560 connections

SITRANS LR560 Specials

Article No.

LR560 Electronics Modules

LR560 Electronics Module, HART, 100 m range, compatible with 7ML54401XX00XAXX, no enclosure or process connection included.

7ML1830-3AC

LR560 Electronics Module, PROFIBUS PA, 100 m range, compatible with 7ML54401XX00XBXX, no enclosure or process connection included.

7ML1830-3AH

LR560 Electronics Module, Foundation Fieldbus, 100 m range, compatible with 7ML54401XX00XCXX, no enclosure or process connection included.

7ML1830-3AJ

LR560 Electronics Module, HART, 40 m range, compatible with 7ML54400XX00XAXX, no enclosure or process connection included.

7ML1830-3AK

LR560 Electronics Module, PROFIBUS PA, 40 m range, compatible with 7ML54400XX00XBXX, no enclosure or process connection included.

7ML1830-3AL

LR560 Electronics Module, Foundation Fieldbus, 40 m range, compatible with 7ML54400XX00XCXX, no enclosure or process connection included.

7ML1830-3AM

LR560 Miscellaneous Spare Kits

Kit, Lid Gasket, EPDM, LR560

7ML1830-3AA

Kit, Wrench for 4" and 6" Aimers, LR560

7ML1830-3AB

Kit, O-rings for 3" Aimer, LR560

7ML1830-3AD

Kit, O-rings for 4" Aimer, LR560

7ML1830-3AE

Kit, O-rings for 6" Aimer, LR560

7ML1830-3AF

Kit, Lid Screw and Purge Plug set with Hex Keys, LR560

7ML1830-3AG

Kit, Lid, No Window, LR560

7ML1830-3AP

Please contact ceg.smpi@siemens.com for special requests.