

Level Measurement

Continuous level measurement - Radar transmitters

SITRANS LR560

Overview

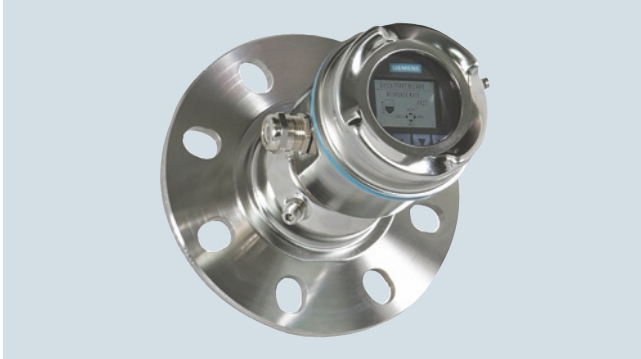

SITRANS LR560 2-wire, 78 GHz FMCW radar level transmitter for continuous monitoring of solids and liquids to a range of 100 m (329 ft).

Benefits

- Rugged stainless steel design for industrial applications
- 78 GHz high frequency provides very narrow beam, virtually no mounting nozzle noise, and optimal reflection from sloped solids
- Aimer option to direct beam to area of interest, such as draw point of cone
- Lens antenna is highly resistant to product buildup
- Air purge connection is included for self-cleaning of extremely sticky solids
- Local display interface (LDI) allows local programming and diagnostics

Application

SITRANS LR560's plug and play performance is ideal for most solids applications and long range liquid applications, including those with extreme dust and high temperatures to 200 °C (392 °F). Unique design allows safe and simple programming using the Intrinsically Safe handheld programmer without having to open the instrument's lid.

SITRANS LR560 includes an optional graphical local display interface (LDI) that improves setup and operation using an intuitive Quick Start Wizard, and echo profile display for diagnostic support. Startup is easy using the Quick Start wizard with a few parameters required for basic operation.

SITRANS LR560 measures practically any solids material to a range of 100 m (328 ft).

- Key Applications: cement powder, plastic powder/pellets, grain, coal, wood powder, fly ash

Configuration

Installation

Note:

- Beam angle is the width of the cone where the energy density is half of the peak energy density
- The peak energy density is directly in front of and in line with the antenna
- There is signal transmitted outside of the beam angle; therefore false targets may be detected

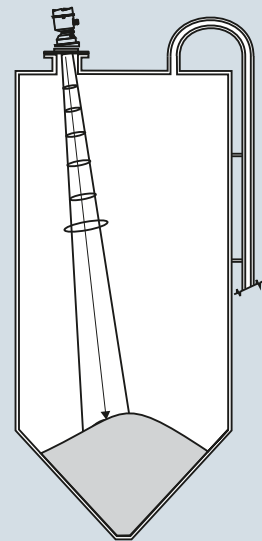
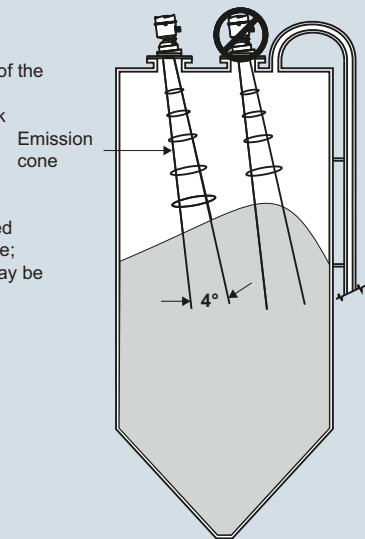

Aiming will assist in measuring material in the cone

SITRANS LR560 installation, dimensions in mm (inch)

Technical specifications

Mode of operation	
Measuring principle	Radar level measurement
Frequency	78 GHz FMCW
Minimum detectable distance	400 mm (15.75 inch) from sensor reference point
Maximum measuring range ¹⁾	<ul style="list-style-type: none"> • 40 m (131 ft) version • 100 m (328 ft) version
Output	
Analog output	4 ... 20 mA
Communications	<ul style="list-style-type: none"> • HART • Optional: PROFIBUS PA • Optional: FOUNDATION Fieldbus
Fail-safe	<ul style="list-style-type: none"> • Programmable as high, low or hold (Loss of Echo) • NE43 programmable
Performance (according to reference conditions IEC60770-1)	
Maximum measured error (including hysteresis and non-repeatability) ²⁾	5 mm (0.2 inch)
Rated operating conditions (according to reference conditions IEC60770-1)	
Installation conditions	
• Location	Indoor/outdoor
Ambient conditions (enclosure)	
• Ambient temperature	-40 ... +80 °C (-40 ... +176 °F)
• Installation category	I
• Pollution degree	4
Medium conditions	
Dielectric constant ϵ_r	> 1.6
Process temperature and pressure	See chart below
Design	
Enclosure	
• Construction	316L/1.4404 stainless steel
• Conduit entry	M20 x 1.5, or ½" NPT via adapter
• Purge inlet	1/8" NPT, 30 cfm at max. 100 psi
• Lens material	<ul style="list-style-type: none"> • 40 m version: PEI • 100 m version: PEEK
	Damage to lens could result from continuous purging/cleaning (due to abrasive solids). Recommended to purge/clean only a few seconds every hour.
• Degree of protection	Type 4X/NEMA 4X, Type 6/NEMA 6, IP68
• Weight	3.15 kg (6.94 lb) including 3 inch flange
• Optional local display interface	Graphic LCD, with bar graph representing level
Process connections	
• Universal flat-faced flanges ³⁾	<ul style="list-style-type: none"> • 3, 4, 6 inch/80, 100, 150 mm, 304 stainless steel • 3, 4, 6 inch/80, 100, 150 mm, 316L/1.4404 or 316L/1.4435 stainless steel
• Universal stamped flange ³⁾	3, 4, 6 inch/80, 100, 150 mm, 304 stainless steel
• Aimer flanges ³⁾	3, 4, 6 inch/80, 100, 150 mm, polyurethane powder-coated cast aluminum

Power supply	
4 ... 20 mA/HART	Nominal 24 V DC (max. 30 V DC) with max. 550 Ω
PROFIBUS PA/FOUNDATION Fieldbus	13.5 mA 9 ... 32 V DC, per IEC 61158-2
Certificates and approvals	
General	CSA _{US/C} , CE, FM
Radio	Europe (R&TTE), FCC, Industry Canada, RCM
Hazardous	
• Europe/International	IECEX SIR 09.0149X ATEX II 1D, 1/2D, 2D Ex ta IIIC T139 °C Da ATEX II 3G Ex nA II T4 Gc Ex nL IIC T4 Gc
• US/Canada	FM/CSA Class II, Div. 1, Groups E, F, G Class III T4 FM/CSA Class I, Div. 2, Groups A, B, C, D, T4 NEPSI Ex nA II T4 Ex nL IIC T4 DIP A20 TA, T139 °C
• China	INMETRO Ex na IIC T4 Gc Ex ta IIIC T139 °C Da
• Brazil	
Programming	
Intrinsically Safe Siemens handheld programmer	Infrared receiver
• Approvals for handheld programmer	IS model: ATEX II 1GD Ex ia IIC T4 Ga Ex iaD 20 T135 °C T _a = -20 ... +50 °C CSA/FM Class I, II, and III, Div. 1, Groups A, B, C, D, E, F, G, T6 T _a = 50 °C
Handheld communicator	HART communicator 375/475
PC	SIMATIC PDM, AMS, PACTware
Display (local)	Graphic local user interface including quick start wizard and echo profile displays

- 1) From sensor reference point
- 2) Under severe EMI/EMC environments per IEC61326-1 or NAMUR NE21, the device error may increase to a maximum of 25 mm (1 inch)
- 3) Universal flange mates with EN 1092-1 (PN16)/ASME B16.5 (150 lb)/JIS 2220 (10K) bolt hole pattern.

Process temperature and pressure

Version	Stainless steel	Aimer flange: -1 ... 0.5 bar	Aimer flange: -1 ... 3.0 bar
40 m	-40 ... +100 °C (-40 ... +212 °F)	-40 ... +100 °C (-40 ... +212 °F)	-40 ... +100 °C (-40 ... +212 °F)
100 m	-40 ... +200 °C (-40 ... +392 °F)	-40 ... +200 °C (-40 ... +392 °F)	-40 ... +120 °C (-40 ... +248 °F)

Level Measurement

Continuous level measurement - Radar transmitters

SITRANS LR560

Selection and Ordering data

SITRANS LR560

2-wire, 78 GHz FMCW radar level transmitter for continuous monitoring of solids and liquids to a range of 100 m (329 ft).

Order handheld programmer separately

➤ Click on the Article No. for the online configuration in the PIA Life Cycle Portal.

Measurement and process temperature range

40 m (131 ft) max range, -40 ... +100 °C ● 0

100 m (329 ft) max range, -40 ... +200 °C ● 1

Process connection

Universal flat-faced flange fits ANSI/DIN/JIS flanges

80 mm/3 inch, 304 stainless steel ● A

100 mm/4 inch, 304 stainless steel ● B

150 mm/6 inch, 304 stainless steel ● C

80 mm/3 inch, 316L stainless steel ● D

100 mm/4 inch, 316L stainless steel ● E

150 mm/6 inch, 316L stainless steel ● F

80 mm/3 inch, painted aluminum, with integral aimer¹⁾ ● G

100 mm/4 inch, painted aluminum, with integral aimer¹⁾ ● H

150 mm/6 inch, painted aluminum, with integral aimer¹⁾ ● J

Universal stamped flange fits ANSI/DIN/JIS flanges

80 mm/3 inch, 304 stainless steel²⁾ ● K

100 mm/4 inch, 304 stainless steel²⁾ ● L

150 mm/6 inch, 304 stainless steel²⁾ ● M

Stainless steel, 1 X 1/2" NPT ● A

Stainless steel, 1 X M20 x 1.5 (plastic gland included) ● B

Enclosure (with cable inlet)

Stainless steel, 1 X 1/2" NPT ● A

Stainless steel, 1 X M20 x 1.5 (plastic gland included) ● B

Pressure rating

0.5 bar g (7.5 psi g) maximum ● 0

3 bar g (40 psi g) maximum ● 1

Output/communication

4 ... 20 mA, HART ● A

PROFIBUS PA ● B

FOUNDATION Fieldbus ● C

Approvals

General Purpose, FM, CSA_{US/C}, Industry Canada, FCC, CE, R&TTE, RCM ● A

CSA/FM Class I, Div. 2, Groups A, B, C, D, Class II, Div. 1, Groups E, F, G, Class III, Industry Canada, FCC ● B

ATEX II 3G Ex nA/nL, 1D, 1/2D, 2D Ex ta, INMETRO ● C

CE, R&TTE, RCM

Local display interface

Without ● 1

With ● 2

¹⁾ Rated to 120 °C max. when used with Pressure rating option 1

²⁾ Available with Pressure Rating option 0 only

● We can offer shorter delivery times for configurations designated with the Quick Ship Symbol ●. For details see page 9/5 in the appendix

Article No.

7ML5440-

00-

Selection and Ordering data

Further designs

Please add "-Z" to Article No. and specify Order code(s).

Plug M12 with mating connector¹⁾²⁾³⁾ ● A50

Plug 7/8" with mating connector¹⁾³⁾⁷⁾ ● A55

Stainless steel tag [69 x 50 mm (2.71 x 1.97 inch)]; Measuring-point number/identification (max. 27 characters); specify in plain text ● Y15

Manufacturer's test certificate: M to DIN 55350, Part 18 and to ISO 9000 ● C11

Inspection Certificate Type 3.1 per EN 10204⁴⁾ ● C12

NAMUR NE43 compliant, device preset to failsafe < 3.6 mA⁵⁾ ● N07

Operating Instructions for HART device

English Article No. A5E34647946

German Article No. A5E36852429

Note: The Operating Instructions should be ordered as a separate line item on the order.

All literature is available to download for free, in a range of languages, at <http://www.siemens.com/processinstrumentation/documentation>

This device is shipped with the Siemens Level and Weighing manual DVD containing the ATEX Quick Start and Operating Instructions library.

Operating Instructions for PROFIBUS PA device

English Article No. A5E34648471

German Article No. A5E36852435

Note: The Operating Instructions should be ordered as a separate line item on the order.

All literature is available to download for free, in a range of languages, at <http://www.siemens.com/processinstrumentation/documentation>

This device is shipped with the Siemens Level and Weighing manual DVD containing the ATEX Quick Start and Operating Instructions library.

Operating Instructions for FOUNDATION Fieldbus device

English Article No. A5E34648692

German Article No. A5E36852443

Note: The Operating Instructions should be ordered as a separate line item on the order.

All literature is available to download for free, in a range of languages, at <http://www.siemens.com/processinstrumentation/documentation>

This device is shipped with the Siemens Level and Weighing manual DVD containing the ATEX Quick Start and Operating Instructions library.

Order code

Accessories

Hand Programmer, Intrinsically safe
 Local display interface
 Sun Shield Cover, 304 stainless steel
 Housing lid with window
 One metallic cable gland M20 x 1.5, rated -40 ... +80 °C (-40 ... +176 °F), HART⁶⁾
 One metallic cable gland M20 x 1.5, rated -40 ... +80 °C (-40 ... +176 °F), PROFIBUS PA⁶⁾
 SITRANS RD100, loop powered display - see Chapter 7
 SITRANS RD200, universal input display with Modbus conversion - see Chapter 7
 SITRANS RD300, dual line display with totalizer and linearization curve and Modbus conversion - see Chapter 7
 SITRANS RD500 web, universal remote monitoring solution for instrumentation - see Chapter 7
 For applicable back up point level switch - see point level measurement section

7ML1930-1BK
7ML1930-1FJ
7ML1930-1FK
7ML1930-1FL
7ML1930-1AP

7ML1930-1AQ

7ML5741-...
7ML5740-...

7ML5744-...

7ML5750-...

- 1) Available with Approval option A only
- 2) Available with Enclosure option B only
- 3) Available with Output/communication options B and C only
- 4) Available with Pressure rating option 1 only
- 5) Available with Output/communication option A only
- 6) Product shipped with plastic cable gland, rated to -20 °C. If -40 °C rating required, then metallic cable gland is recommended
- 7) Only available with enclosure option A (NPT thread)

◆ We can offer shorter delivery times for configurations designated with the Quick Ship Symbol ◆. For details see page 9/5 in the appendix

Options**Handheld programmer**

Article number:
7ML1930-1BK

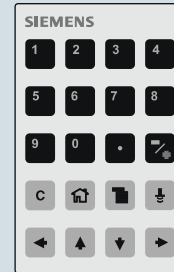
**Sun shield cover**
(304 stainless steel)

Article number:
7ML1930-1FK

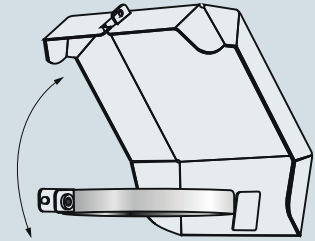

SITRANS LR560 handheld programmer and sun shield cover

Level Measurement

Continuous level measurement - Radar transmitters

SITRANS LR560

Characteristic curves

Temperature derating curve

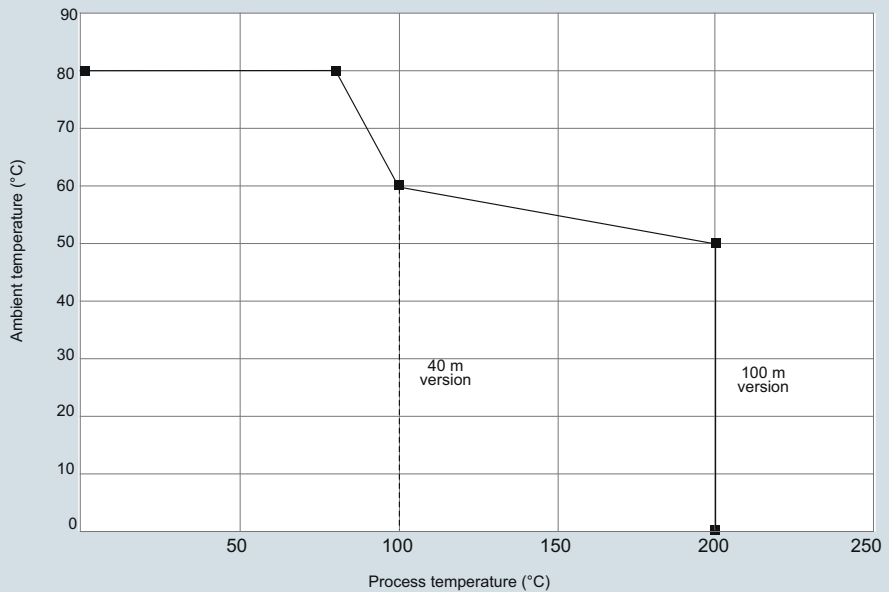
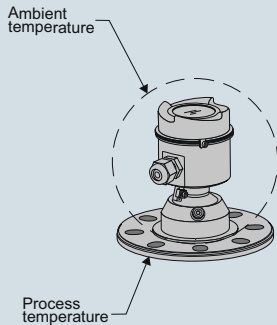

SITRANS LR560 temperature derating curve

Dimensional drawings

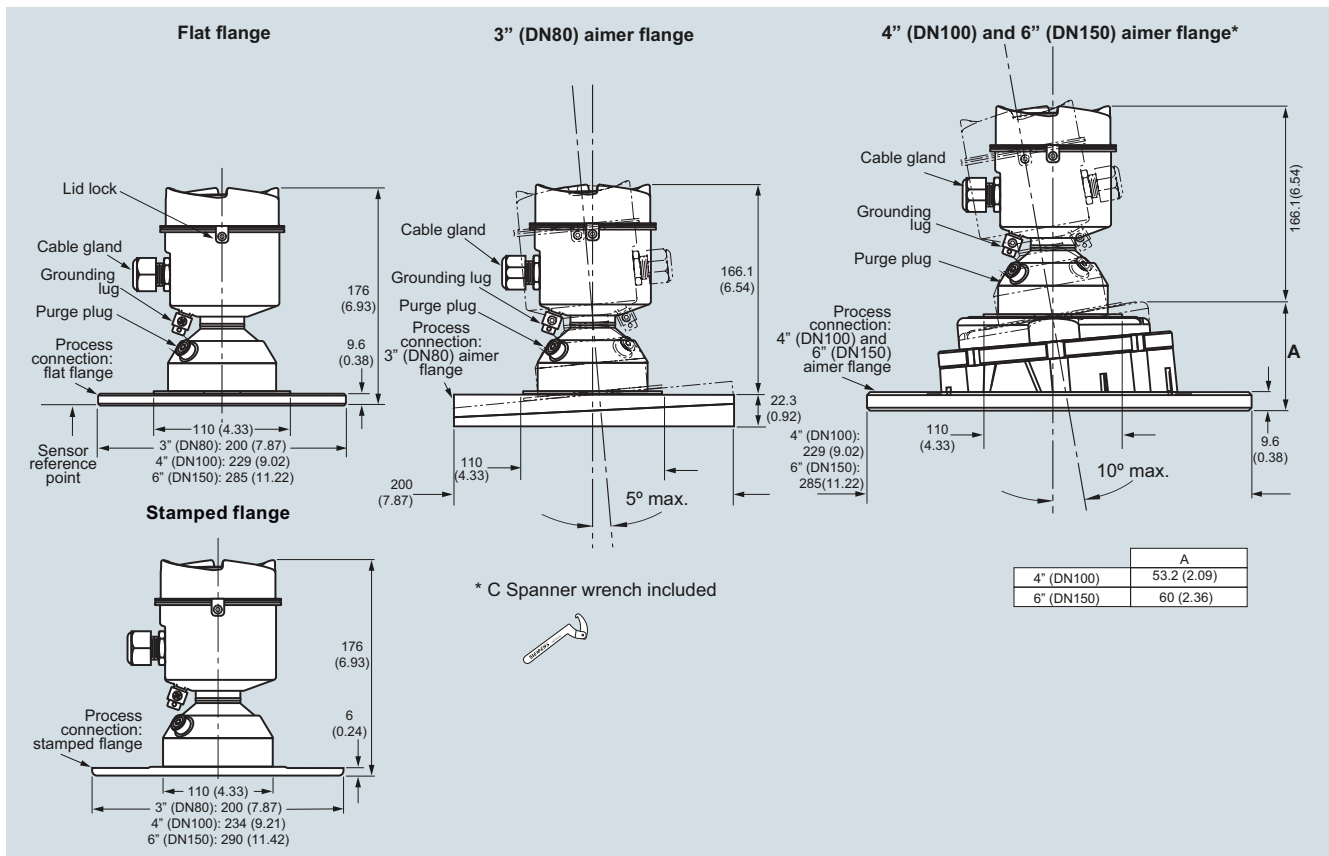

SITRANS LR560, dimensions in mm (inch)

Schematics

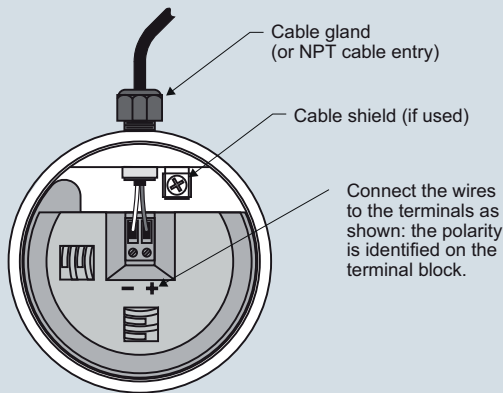

Notes:

1. Depending on the approval rating, glands and plugs may be supplied with your instrument.
2. DC terminal shall be supplied from a source providing electrical isolation between the input and output, to meet the applicable safety requirements of IEC 61010-1.
3. All field wiring must have insulation suitable for rated input voltages.
4. Use shielded twisted pair cable (14 ... 22 AWG) for HART version.
5. Separate cables and conduit may be required to conform to standard instrumentation wiring practices or electrical codes.

SITRANS LR560 connections

Selection and ordering data

SITRANS LR560 Specials

	Article No.
SITRANS LR560 Electronics Modules	
SITRANS LR560 Electronics Module, HART, 100 m range, compatible with 7ML54401XX-00XAXX, no enclosure or process connection included.	7ML1830-3AC
SITRANS LR560 Electronics Module, PROFIBUS PA, 100 m range, compatible with 7ML54401XX00XBXX, no enclosure or process connection included.	7ML1830-3AH
SITRANS LR560 Electronics Module, FOUNDATION Fieldbus, 100 m range, compatible with 7ML54401XX00XCXX, no enclosure or process connection included.	7ML1830-3AJ
SITRANS LR560 Electronics Module, HART, 40 m range, compatible with 7ML54400XX-00XAXX, no enclosure or process connection included.	7ML1830-3AK
SITRANS LR560 Electronics Module, PROFIBUS PA, 40 m range, compatible with 7ML54400XX00XBXX, no enclosure or process connection included.	7ML1830-3AL
SITRANS LR560 Electronics Module, FOUNDATION Fieldbus, 40 m range, compatible with 7ML54400XX00XCXX, no enclosure or process connection included.	7ML1830-3AM
SITRANS LR560 Miscellaneous Spare Kits	
Kit, lid gasket, EPDM	7ML1830-3AA
Kit, wrench for 4" and 6" Aimers	7ML1830-3AB
Kit, O-rings for 3" Aimer	7ML1830-3AD
Kit, O-rings for 4" Aimer	7ML1830-3AE
Kit, O-rings for 6" Aimer	7ML1830-3AF
Kit, lid screw and purge plug set with hex keys	7ML1830-3AG
Kit, lid, no window	7ML1830-3AP

Customers interested in a custom designed device should consult a local sales person. For more information, please visit http://www.automation.siemens.com/asp_app.