

Radar Transmitters

SITRANS LR260 (HART)

Quick Start Manual · 12/2013



SITRANS

SIEMENS

Safety Guidelines

Warning notices must be observed to ensure personal safety as well as that of others, and to protect the product and the connected equipment. These warning notices are accompanied by a clarification of the level of caution to be observed.



WARNING: relates to a caution symbol on the product, and means that failure to observe the necessary precautions can result in death, serious injury, and/or considerable material damage.



WARNING¹: means that failure to observe the necessary precautions can result in death, serious injury, and/or considerable material damage.

Note: means important information about the product or that part of the operating manual.

FCC Conformity

US Installations only: Federal Communications Commission (FCC) rules



WARNING: Changes or modifications not expressly approved by Siemens Milltronics could void the user's authority to operate the equipment.

Notes:

- This equipment has been tested and found to comply with the limits for a Class A digital device, pursuant to Part 15 of the FCC Rules. These limits are designed to provide reasonable protection against harmful interference when the equipment is operated in a commercial environment.
- This equipment generates, uses, and can radiate radio frequency energy and, if not installed and used in accordance with the Operating Instructions may cause harmful interference to radio communications. Operation of this equipment in a residential area is likely to cause harmful interference to radio communications, in which case the user will be required to correct the interference at his own expense.

SITRANS LR260



WARNING: SITRANS LR260 is to be used only in the manner outlined in this manual, otherwise protection provided by the equipment may be impaired.

SITRANS LR260 is a 2-wire 25 GHz pulse radar level transmitter for continuous monitoring of solids and liquids in storage vessels including extreme levels of dust and high temperatures, to a range of 30 m (98.4 ft).

The instrument consists of an electronic component coupled to a horn antenna with an integral Easy Aimer and flange for quick and easy positioning. A dust cover or air purging are available as options.

SITRANS LR260 supports HART communication protocol, and SIMATIC PDM software. Signals are processed using Process Intelligence which has been field-proven in over 1,000,000 applications worldwide (ultrasonic and radar).

¹ This symbol is used when there is no corresponding caution symbol on the product.

Specifications

For a complete listing, see the SITRANS LR260 (HART) Operating Instructions. For Approvals information, please refer to the device nameplate and the process device tag.

Ambient/Operating Temperature

Notes:

- Process temperature and pressure capabilities are dependent upon information on the process device tag. The reference drawing listed on the tag can be downloaded from the Siemens website at: www.siemens.com/LR260.
- See *Loop power* on page 19, for more details.

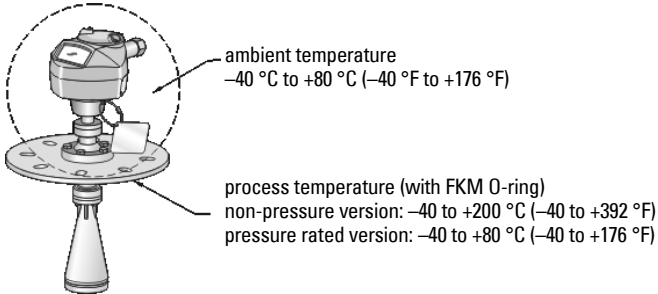

Power



Nominal 24 V DC with max. 550 Ohm loop resistance. (Check the device nameplate for the characteristics of the device, and confirm the loop load.)

- Maximum 30 V DC
- 4 to 20 mA

Approvals

- General CSA_{US/C}, FM, CE, C-TICK
- Radio Europe (R&TTE), FCC, Industry Canada
- Hazardous ATEX II 1G, 1/2D, 2D Ex ia IIC T4 Ga, Ex ta IIIC T100 °C Da
ATEX II 3G Ex nA IIC T4 Gc
IECEx SIR 11.0153X Ex ia IIC T4 Ga, Ex ta IIIC T100 °C Da
FM/CSA Class I, Div. 1, Groups A, B, C, D Class II, Div. 1, Groups E, F, G, Class III T4
FM/CSA Class I, Div. 2, Groups A, B, C, D T5
SABS ARP0108 Ex ia IIC T4 Ga
INMETRO:DNV 12.0081 X
Ex ia IIC T4 Ga
Ex ta IIIC T100 °C Da
-40 °C ≤ Ta ≤ +80 °C
IP67/IP68
DNV #OCP 0017
ABNT NBR IEC 60079-0:2008
ABNT NBR IEC 60079-11:2009
ABNT NBR IEC 60079-26:2008 e
ABNT NBR IEC 60079-31:2011

Note: Use appropriate conduit seals to maintain IP or NEMA rating.

Pressure Application



WARNINGS:

- This product is designated as a Pressure Accessory per Directive 97 / 23 / EC, and is not intended for use as a safety device.
- Do not attempt to loosen, remove, or disassemble process connection or instrument housing while vessel contents are under pressure.
- Improper installation may result in loss of process pressure.

Installation



WARNINGS:

- Installation shall only be performed by qualified personnel and in accordance with local governing regulations.
- Materials of construction are chosen based on their chemical compatibility (or inertness) for general purposes. For exposure to specific environments, check with chemical compatibility charts before installing.

Notes:

- For European Union and member countries, installation must be according to ETSI EN 302372.
- The Process Device Tag shall remain with the process pressure boundary assembly¹. In the event the device package is replaced, the Process Device Tag shall be transferred to the replacement unit.
- SITRANS LR260 units are hydrostatically tested, meeting or exceeding the requirements of the ASME Boiler and Pressure Vessel Code and the European Pressure Equipment Directive.

¹. The process pressure boundary assembly comprises the components that act as a barrier against pressure loss from the process vessel: that is, the combination of process connection body and emitter, but normally excluding the electrical enclosure.

Installation guidelines

- Provide easy access for viewing the display and programming via the hand programmer.
- Provide an environment suitable to the housing rating and materials of construction.
- Provide a sunshield if the device will be mounted in direct sunlight.

Nozzle design

- The end of the horn must protrude a minimum of 10 mm (0.4") to avoid false echoes being reflected from the nozzle.
- Optional antenna extensions: 100 mm (3.93"), 200 mm (7.09"), 500 mm (19.69"), 1000 mm (39.4")¹

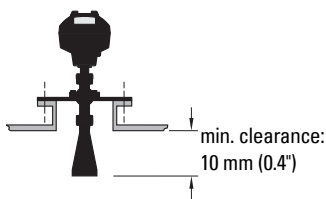

Nozzle location

Note: Beam angle depends on horn size.

- Keep emission cone free of interference from ladders, pipes, I-beams or filling streams.
- Avoid central locations on tall, narrow vessels.
- Align the antenna so that the radar cone is perpendicular to the surface of the monitored material, if possible.

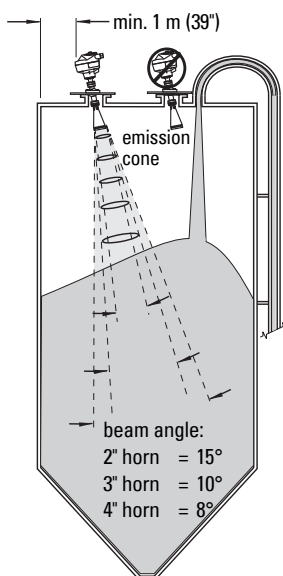

Mounting instructions

! WARNING: The user is responsible for the selection of bolting and gasket materials which will fall within the limits of the flange and its intended use, and which are suitable for the service conditions.

¹ Extensions are not recommended for applications where there may be excessive visible vibration. Please consult factory for more information.

Wiring

Power

WARNINGS:



The DC input terminals shall be supplied from a source providing electrical isolation between the input and output, meeting the applicable safety requirements of IEC 61010-1.



All field wiring must have insulation suitable for rated voltages.

Connecting SITRANS LR260



WARNINGS:

- Check the device nameplate and process device tag, to verify the approval rating.
- Use appropriate conduit seals to maintain IP or NEMA rating.
- Read *Instructions specific to hazardous area installations* on page 9.

Notes:

- For detailed wiring instructions, please refer to the full Operating Instructions.
- Use twisted pair cable: AWG 22 to 14 (0.34 mm² to 2.5 mm²).
- Separate cables and conduits may be required to conform to standard instrumentation wiring practices, or electrical codes.

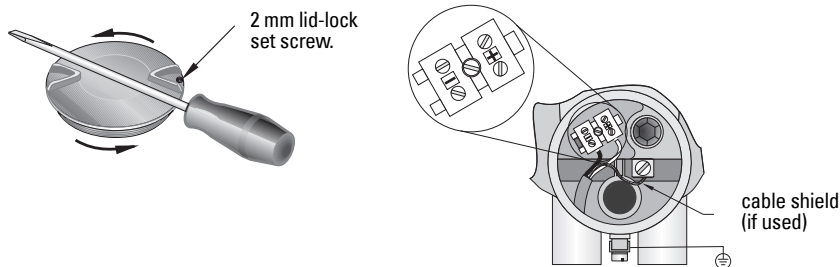

1. Use a 2 mm Allen key to loosen the lid-lock set screw. Then using a screwdriver for leverage if necessary, unscrew the cover.
2. Strip the cable jacket for approximately 70 mm (2.75") from the end of the cable, and thread the wires through the gland.
3. Connect the wires to the terminals as shown: the polarity is identified on the terminal block.
4. Ground the instrument according to local regulations.
5. Tighten the gland to form a good seal.

2. Non-Sparking wiring

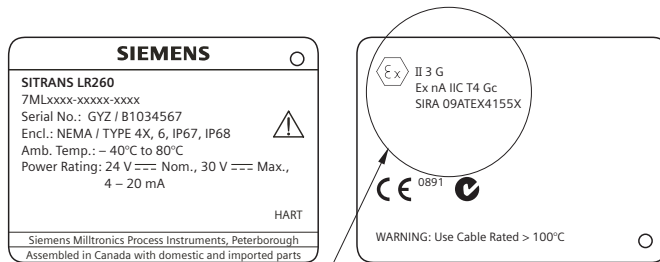

The ATEX certificate listed on the nameplate can be downloaded from the product page of our website at: www.siemens.com/LR260. Go to **Support > Approvals / Certificates**.

- For power demands see *Loop Voltage versus Loop Resistance* on page 19.
- For wiring requirements: follow local regulations.
- Refer to *Instructions specific to hazardous area installations* on page 9.

3. Non-incendive wiring (US/Canada only)

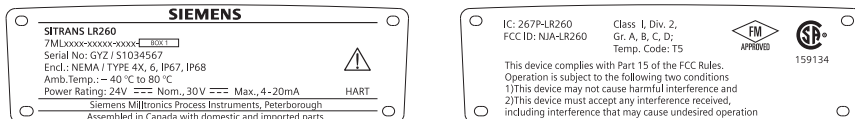

FM/CSA Class 1, Div 2 connection drawing number A5E03745541

can be downloaded from the product page of our website at: www.siemens.com/LR260. Go to **Support > Installation Drawings > Level Measurement > Continuous - Radar**.

- For power demands see *Loop Voltage versus Loop Resistance* on page 19.

Instructions specific to hazardous area installations (Reference European ATEX Directive 94/9/EC, Annex II, 1.0.6)

The following instructions apply to equipment covered by certificate number SIRA 11ATEX2348X, and SIRA 09ATEX4155X.

- 1) For use and assembly, refer to the main instructions.
- 2) The equipment is certified for use as Category 1GD, 1/2D, 2D equipment per SIRA 11ATEX2348X; and Category 3G equipment per SIRA 09ATEX4155X.
- 3) The equipment may be used with flammable gases and vapors with apparatus group IIC, IIB and IIA and temperature classes T1, T2, T3 and T4.
- 4) The equipment has a degree of ingress protection of IP67 and a temperature class of T100°C and may be used with flammable dusts.
- 5) The equipment is certified for use in an ambient temperature range of -40 °C to 80 °C.
- 6) The equipment has not been assessed as a safety related device (as referred to by Directive 94/9/EC Annex II, clause 1.5).
- 7) Installation and inspection of this equipment shall be carried out by suitably trained personnel in accordance with the applicable code of practice (EN 60079-14 and EN 60079-17 in Europe).
- 8) The equipment is non-repairable.
- 9) The certificate numbers have an 'X' suffix, which indicates that special conditions for safe use apply. Those installing or inspecting this equipment must have access to the certificates.
- 10) If the equipment is likely to come into contact with aggressive substances, then it is the responsibility of the user to take suitable precautions that prevent it from being adversely affected, thus ensuring that the type of protection is not compromised.
 - Aggressive substances: for example, acidic liquids or gases that may attack metals, or solvents that may affect polymeric materials.
 - Suitable precautions: for example, establishing from the material's data sheet that it is resistant to specific chemicals.

SPECIAL CONDITIONS FOR SAFE USE

The 'X' suffix to the certificate number relates to the following special condition(s) for safe use:

- Unused cable entries shall be fitted with blanking elements that can only be removed with the aid of a tool.
- Any glands, conduit entry devices or blanking elements fitted to the equipment shall be suitable for use in the presence of combustible dusts and certified as such by a notified body; the installation of these devices shall not compromise the IP6X rating of the equipment enclosure.
- For applications that use the purge facility, the user shall provide a means to ensure that combustible dust from the hazardous area cannot enter the purge supply in such a way as to compromise the area classification.

Programming SITRANS LR260

A Quick Start Wizard provides an easy step-by-step guide to help you configure the device for a simple application.

- 7-step *Quick Start Wizard via the handheld programmer* on page 15.
- 4-step *Quick Start Wizard via SIMATIC PDM* on page 18.

Settings can be modified locally via the Local User Interface (see *Accessing parameters via the handheld programmer* on page 13) or remotely via SIMATIC PDM. The Local User Interface(LUI) consists of an LCD display and a handheld programmer.

Activating SITRANS LR260

Power up the device. SITRANS LR260 automatically starts up in Measurement mode. Press

Mode  to toggle between Measurement and Program Mode.

The LCD Display

Measurement mode (normal operation)

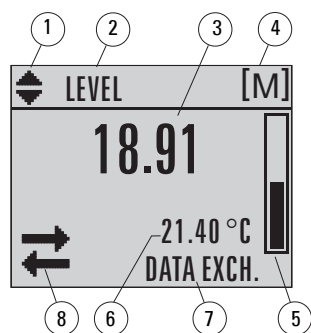

- 1 – toggle indicator for linear units or %
- 2 – selected operation: level, space, or distance
- 3 – measured value (level, space, or distance)
- 4 – units
- 5 – bar graph indicates level
- 6 – secondary region indicates on request¹ electronics temperature, echo confidence, loop current, or distance
- 7 – text area displays status messages
- 8 – device status indicator

Fault present



S: 0 LOE

- 7 – text area displays a fault code and an error message
- 8 – service required icon appears

¹ In response to a key press request. For details, see *Key functions in Measurement mode* on page 12.

PROGRAM mode display

Navigation view

- A visible menu bar indicates the menu list is too long to display all items.
- A band halfway down the menu bar indicates the current item is halfway down the list.
- The depth and relative position of the item band on the menu bar indicates the length of the menu list, and approximate position of the current item in the list.
- A deeper band indicates fewer items.

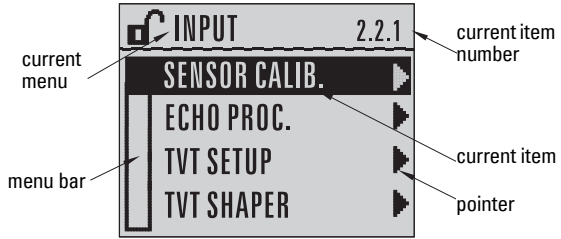

Parameter view

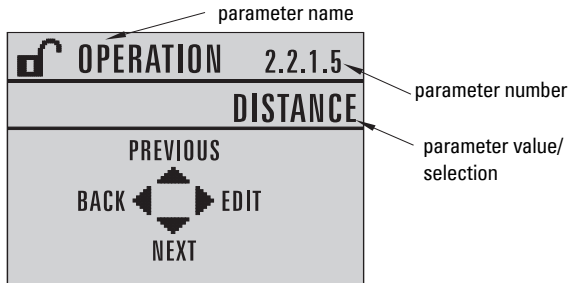

Edit view

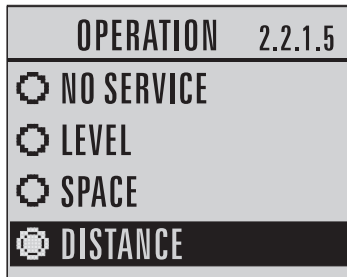







Handheld Programmer (Part No. 7ML1930-2AJ)

The programmer is ordered separately.



Key functions in Measurement mode

Key	Function	Result
	Updates the loop current.	New value is displayed in LCD secondary region.
	Updates internal enclosure temperature reading.	New value is displayed in LCD secondary region.
	Updates echo confidence value.	New value is displayed in LCD secondary region.
	Updates distance measurement.	New value is displayed in LCD secondary region.
	Mode opens PROGRAM mode.	Opens the menu level last displayed in this power cycle, unless power has been cycled since exiting PROGRAM mode or more than 30 minutes have elapsed since PROGRAM mode was used. Then top level menu will be displayed.
	RIGHT arrow opens PROGRAM mode.	Opens the top level menu.
	UP or DOWN arrow toggles between linear units and %	LCD displays measured value in either linear units or percent.

Accessing parameters via the handheld programmer

Note: SITRANS LR260 automatically returns to Measurement mode after a period of inactivity in PROGRAM mode (between 15 seconds and 30 minutes, depending on the menu level).

Parameter menus

Parameters are identified by name and organized into function groups, then arranged in a 5-level menu structure. For the complete list of parameters with instructions, see the full Operating Instructions..

Note:

In Navigation mode **arrow keys** move to the next menu item in the direction of the arrow.

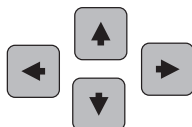

1. QUICK START

2. SETUP

2.1. DEVICE

2.2. INPUT

2.2.1. SENSOR CALIB.

2.2.4. ECHO PROC.

1. Enter PROGRAM mode





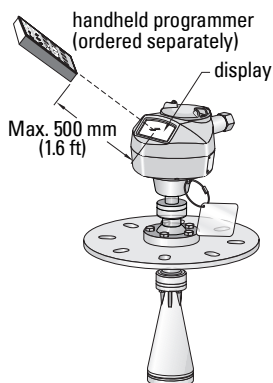

- Point the programmer at the display (from a maximum distance of 500 mm [1.6 ft.]).

- RIGHT arrow**  activates PROGRAM mode and opens menu level 1.

- Mode**  opens the menu level last displayed in PROGRAM mode within the last 30 minutes, or menu level 1 if power has been cycled since then.





2. Navigating: key functions in Navigation mode

Key	Name	Menu level	Function
 	UP or DOWN arrow	menu or parameter	Scroll to previous or next menu or parameter.
	RIGHT arrow	menu	Go to first parameter in the selected menu, or open next menu.
		parameter	Open Edit mode.
	LEFT arrow	menu or parameter	Open parent menu.
	Mode	menu or parameter	Change to MEASUREMENT mode.
	Home	menu or parameter	Open top level menu: menu 1.



3. Editing in PROGRAM mode

Selecting a listed option

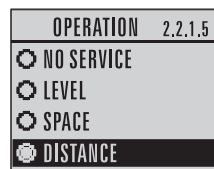
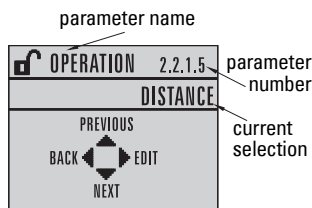
- Navigate to the desired parameter.
- Press **RIGHT arrow**  to open parameter view.
- Press **RIGHT arrow**  again to open **Edit** mode. The current selection is highlighted.
- Scroll to a new selection.
- Press **RIGHT arrow**  to accept it
- The LCD returns to parameter view and displays the new selection.







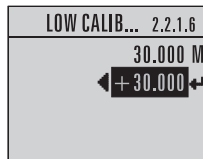
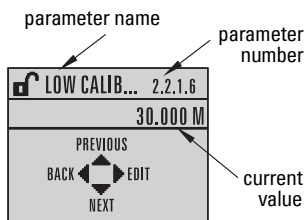



Changing a numeric value

- Navigate to the desired parameter.
- Press **RIGHT arrow**  to open parameter view. The current value is displayed.
- Press **RIGHT arrow**  again to open **Edit** mode. The current value is highlighted.
- Key in a new value.
- Press **RIGHT arrow**  to accept it. The LCD returns to parameter view and displays the new selection.



Key functions in Edit mode

Key	Name	Function
 	UP or DOWN arrow	Selecting options <ul style="list-style-type: none"> • Scrolls to item. Alpha-numeric editing <ul style="list-style-type: none"> • Increments or decrements digits • Toggles plus and minus sign
	RIGHT arrow	Selecting options <ul style="list-style-type: none"> • Accepts the data (writes the parameter) • Changes from Edit to Navigation mode Numeric editing <ul style="list-style-type: none"> • Moves cursor one space to the right • or with cursor on Enter sign, accepts the data and switches from Edit to Navigation mode
	LEFT arrow	Selecting options <ul style="list-style-type: none"> • Cancels Edit mode without changing the parameter Numeric editing <ul style="list-style-type: none"> • Moves cursor to plus/minus sign if this is the first key pressed • or moves cursor one space to the left. • or with cursor on Enter sign, cancels the entry







Key	Name	Function (continued)	
	Clear	Numeric editing	<ul style="list-style-type: none"> Erases the display.
	Decimal point	Numeric editing	<ul style="list-style-type: none"> Enters a decimal point.
	Plus or minus sign	Numeric editing	<ul style="list-style-type: none"> Changes the sign of the entered value.
	Numeral	Numeric editing	<ul style="list-style-type: none"> Enters the corresponding character.

Quick Start Wizard via the handheld programmer

Notes:

- The Quick Start Wizard settings are inter-related and changes apply only after you click on **Yes in Apply?** at the end of the Quick Start steps.
- Do not use the Quick Start wizard to modify individual parameters: see full parameter listing in Operating Instructions (perform customization for your application only after the Quick Start has been completed).

1. Quick Start

- Point the programmer at the display (from a maximum distance of 500 mm [1.6 ft.]), then press **RIGHT arrow**  to activate PROGRAM mode and open menu level 1.
- Press **RIGHT arrow**  twice to navigate to menu item 1.1 and open parameter view.
- Press **RIGHT arrow**  to open **Edit** mode or **DOWN arrow**  to accept default values and move directly to the next item.
- To change a setting, scroll to the desired item or key in a new value.
- After modifying a value, press **RIGHT arrow**  to accept it and press **DOWN arrow**  to move to the next item.
- Quick Start settings take effect only after you click **Yes in Apply?** at the end of the Quick Start steps.

1.1. Material

Options	STEEL (Default)
	CONCRETE

1.2. Response Rate

Sets the reaction speed of the device to measurement changes in the target range.

Options	SLOW	0.1 m/minute
	MED	1.0 m/minute
	FAST	10.0 m/minute (Default)

Use a setting just faster than the maximum filling or emptying rate (whichever is greater).

1.3. Sensor Units

Selects the units for the Quick Start variables (high and low calibration point, and level, distance, or space).

Options

M, CM, MM, FT, IN
Default: M

1.4. Operation

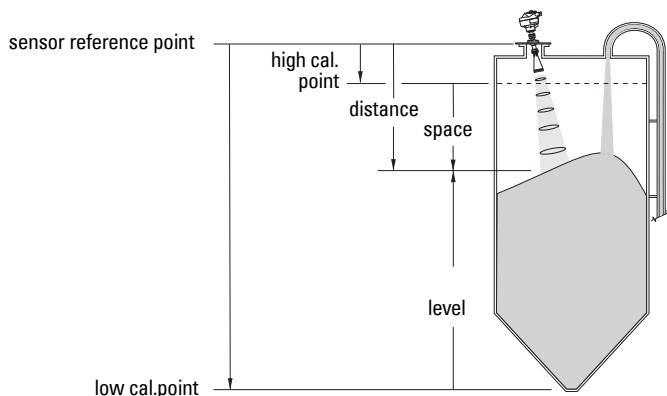

Operation types	NO SERVICE	The SITRANS LR260 stops updating measurements and associated loop current. Last valid measurement is displayed.
	LEVEL	Distance to material surface referenced from Low Calibration Point (process empty level).
	SPACE	Distance to material surface referenced from High Calibration Point (process full level).
	DISTANCE	Distance to material surface referenced from Sensor Reference Point.
	Default: Distance	

1.5. Low Calibration Point

Distance from Sensor Reference to Low Calibration Point: usually process empty level. See **Operation (1.4.)** for an illustration.

Values	Range: 0.0000 to 30.000 m
---------------	---------------------------

1.6. High Calibration Point

Distance from Sensor Reference to High Calibration Point: usually process full level. See **Operation (1.4.)** for an illustration.

Values	Range: 0.0000 to 30.000 m
---------------	---------------------------

1.7. Apply? (Apply changes)

In order to save the Quick Start settings it is necessary to select **Yes** to apply changes.

Options	YES, NO, DONE (Display shows DONE when Quick Start is successfully completed)
----------------	--

Press **Mode**  to return to Measurement mode. SITRANS LR260 is now ready to operate.

Note: For liquid applications, some parameters must be modified following the Quick Start Wizard. See full Operating Instructions for details.

SITRANS LR260 Communications: HART

- You will need the full Operating Instructions to acquire the list of applicable parameters.
- We recommend that you use SIMATIC Process Device Manager (PDM) to program your device.

SIMATIC PDM

SIMATIC PDM is a software package used to commission and maintain SITRANS LR260 and other process devices. Please consult the operating instructions or online help for details on using SIMATIC PDM. (You can find more information at www.fielddevices.com: go to **Products and Solutions > Products and Systems > Communications and Software > Process Device Manager**.)

Device Description (EDD)

Note: SITRANS LR260 requires the EDD for SIMATIC PDM version 6.0 with SP3, or higher.

- You can locate the EDD in Device Catalog, under **Sensors/Level/Echo/Siemens Milltronics/SITRANS LR260**.
- Check the product page of our website at: www.siemens.com/LR260, under **Downloads**, to make sure you have the latest version of SIMATIC PDM, the most recent Service Pack (SP) and the most recent hot fix (HF). If you need to install a new EDD see *Configuring a new device* below.

Configuring a new device

Note: Clicking on **Cancel** during an upload from device to SIMATIC PDM will result in some parameters being updated.

1. Check that you have the most recent EDD, and if necessary download it from the product page listed above. Save the files to your computer, and extract the zipped file to an easily accessed location. Launch **SIMATIC PDM – Manage Device Catalog**, browse to the unzipped EDD file and select it.
2. Launch SIMATIC Manager and create a new project for LR260. Application Guides for setting up HART devices with SIMATIC PDM can be downloaded from the product page of our website at: www.siemens.com/LR260.
3. Upload parameters to the PC/PG.
4. Configure the device via the Quick Start wizard (see page 18).

Quick Start Wizard via SIMATIC PDM

Notes:

- The Quick Start wizard settings are inter-related and changes apply only after you click on **Transfer** at the end of step 4.
- Do not use the Quick Start Wizard to modify individual parameters. (Perform customization only after the Quick Start has been completed.)
- Initial Quick Start parameter values are not default values and do not necessarily reflect the current device configuration.
- Click on **BACK** to return and revise setting or **Cancel** to exit the Quick Start.

Launch SIMATIC PDM, open the menu **Device – Quick Start**, and follow steps 1 to 4.

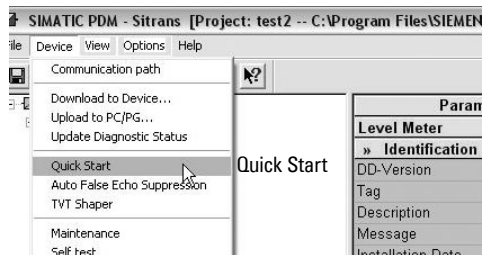

Note: For liquid applications, some parameters must be modified following the Quick Start Wizard. See full Operating Instructions for details.

Maintenance

SITRANS LR260 requires no maintenance or cleaning under normal operating conditions. If cleaning becomes necessary under severe operating conditions:

1. Note the antenna material and the process medium, and select a cleaning solution that will not react adversely with either.
2. Remove the device from service and wipe the antenna clean using a cloth and suitable cleaning solution.

Unit Repair and Excluded Liability

For detailed information, please see the inside back cover.

Loop power

Typical Connection Drawing

Note: Loop voltage is the voltage at the terminals of the power supply (not the voltage at the terminals of the device).

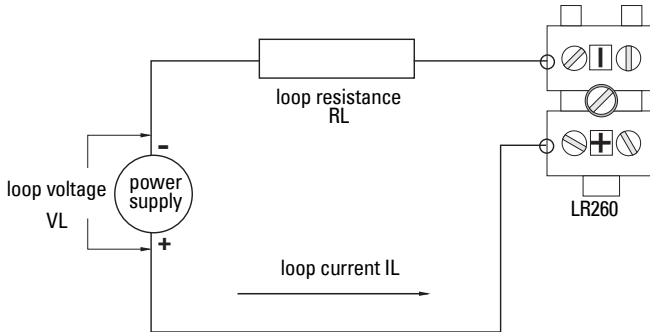

Allowable operating area of SITRANS LR260

Loop Voltage versus Loop Resistance

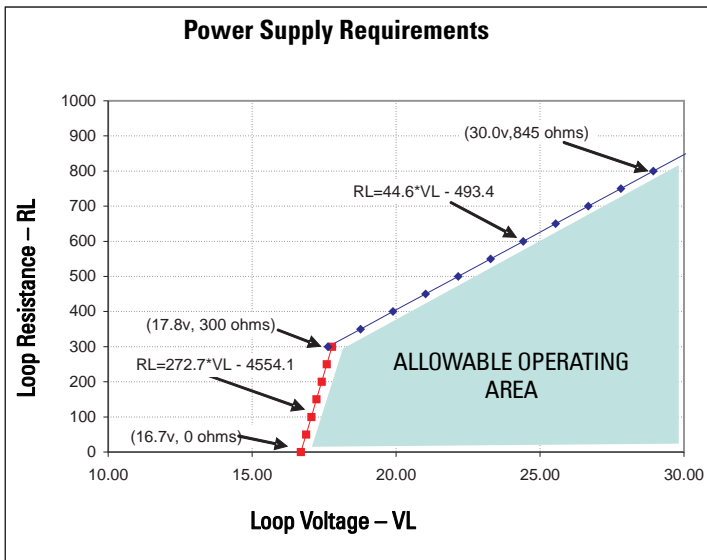

Notes
