

# SIEMENS

## SITRANS F

### Coriolis Flowmeters

#### SITRANS FCS400 sensor

#### Quick Start

Before installing, including in hazardous areas, refer to the Operating Instructions on the internet or on the SITRANS F documentation CD-ROM which is included in the product package. They contain detailed safety regulations, information and specifications which must be observed when installing. Documentation and approvals can be found on the internet:

Flow documentation (<http://www.siemens.com/flowdocumentation>)

#### CAUTION

##### Proper handling

Correct, reliable operation of the device requires proper transport, storage, positioning and assembly. The device must be carefully operated and maintained. Only qualified personnel should install or operate this device.

## Items supplied

### Compact system

- SITRANS FC430 sensor and compact mounted transmitter
- Packet of cable glands
- Quick Start guide
- CD containing software, certificates and device manuals

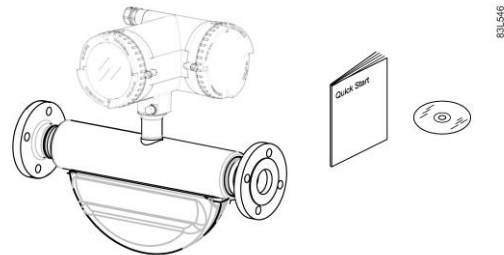

### Remote system

#### Remote with M12

- SITRANS FCS400 sensor
- SITRANS FCT030 transmitter with M12 socket assembled
- Sensor cable with M12 connector
- Packet of cable glands
- Quick Start guide
- CD containing software, certificates and device manuals

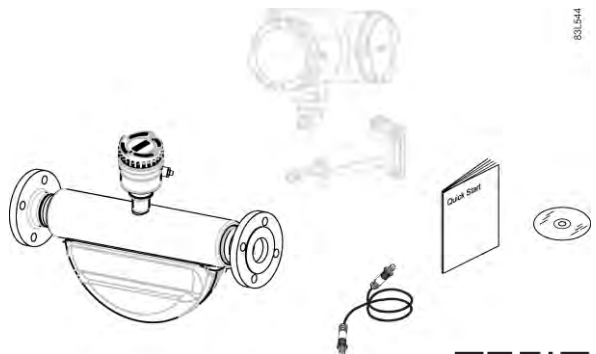

How to install

## Remote with sensor terminal housing

- SITRANS FCS400 sensor
- SITRANS FCT030 transmitter with terminal housing assembled
- Sensor cable
- Packet of cable glands
- Quick Start guide
- CD containing software, certificates and device manuals

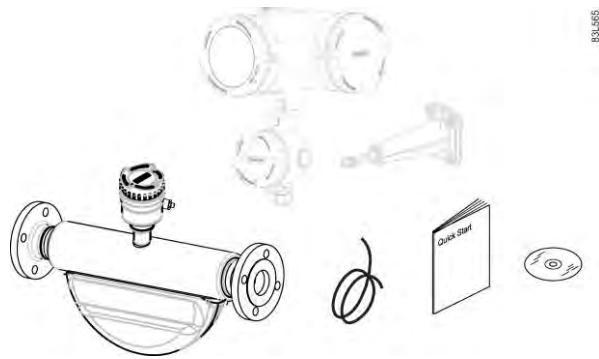

---

### Note

Scope of delivery may vary, depending on version and add-ons. The contents list in the product package lists all included parts.

---

### Note

#### Transmitter installation

The installation of the FCT030 transmitter is described in the SITRANS FCT030 Quick Start (A5E03650800).

---

## Sensor overview

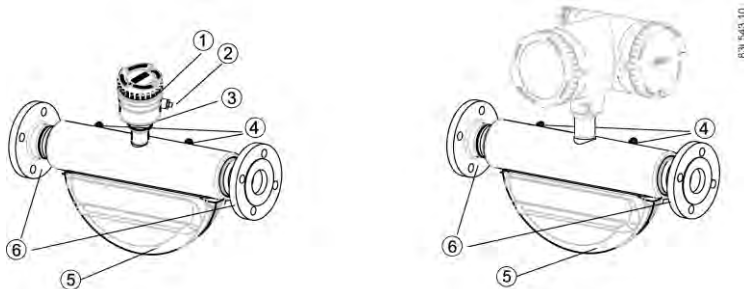

- ① Lid-lock
- ② Cable feed-through (M12 socket or gland)
- ③ Sensor front end (DSL) (Remote configuration only)
- ④ Plug and threaded port for e.g. pressure guard
- ⑤ Sensor enclosure
- ⑥ Process connections

## Location in the system

The optimum location in the system depends on the application:

- Liquid applications
  - Gas or vapor bubbles in the fluid may result in erroneous measurements, particularly in the density measurement.
  - Do not install the flowmeter at the highest point in the system, where bubbles will be trapped.
  - Install the flowmeter in low pipeline sections, at the bottom of a U-section in the pipeline.

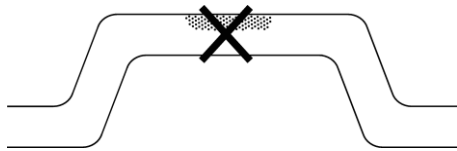

Figure 3-1 Liquid applications, wrong location with trapped air/gas

- Gas applications  
Vapor condensation or oil traces in the gas may result in erroneous measurements.
  - Do not install the flowmeter at the lowest point of the system.
  - Install a filter.

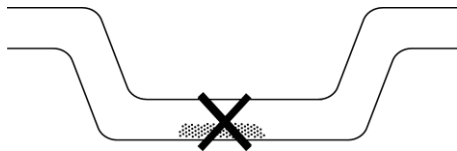

Figure 3-2 Gas applications, wrong location with trapped oil

### Flow direction

The calibrated flow direction is indicated by the arrow on the sensor. Flow in this direction will be indicated as positive by default. The sensitivity and the accuracy of the sensor do not change with reverse flow.

The indicated flow direction (positive/negative) is configurable.

**⚠ CAUTION**

**Accurate measurement**  
The sensor must always be completely filled with process media in order to measure accurately.

### Orienting the sensor

The sensor operates in any orientation. The optimal orientation depends on the process fluid and the process conditions. Siemens recommends orienting the sensor in one of the following ways:

1. Vertical installation with an upwards flow (self-draining)

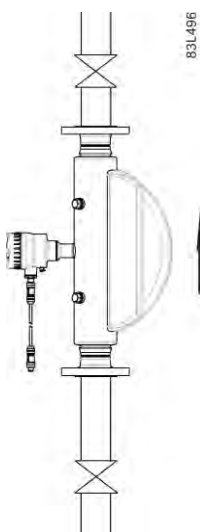

Figure 3-3 Vertical orientation, upwards flow

2. Horizontal installation, tubes down (recommended for liquid applications)

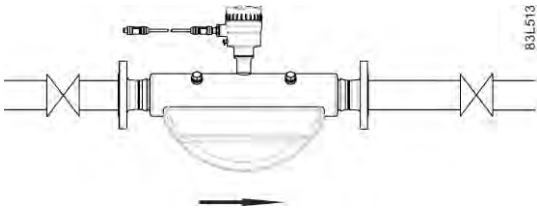

Figure 3-4 Horizontal orientation, tubes down

3. Horizontal installation, tubes up (recommended for gas applications)

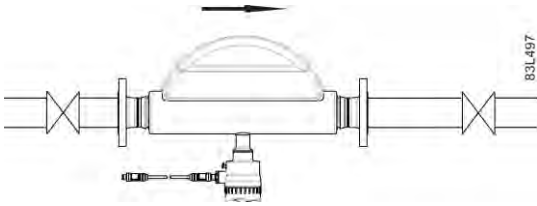

Figure 3-5 Horizontal orientation; tubes up

---

**Note**

**Hygienic applications**

In 3A and EHEDG certified hygienic applications the flowmeter must be installed vertically as shown in 1 above.

---

**Installation in a drop line**

Installation in a drop line is only recommended if a pipeline reduction or orifice with a smaller cross-section can be installed to create back-pressure and prevent the sensor from being partially drained while measuring.

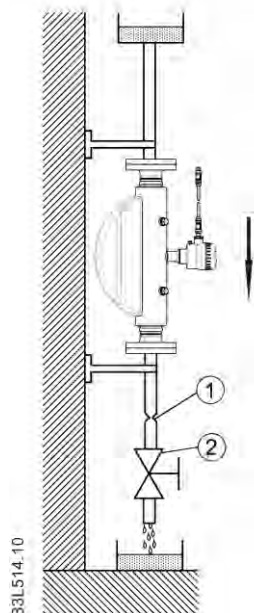

- ① Back pressure orifice
- ② On / off valve

Figure 3-6 Installation in drop line

# Mounting the sensor

## NOTICE

### Incorrect mounting

The device can be damaged, destroyed or its functionality impaired through improper mounting.

- Before installing ensure there is no visible damage present on the device.
- Make sure that process connectors are clean, and suitable gaskets and glands are used.
- Mount the device using suitable tools.



## WARNING

### Unsuitable connecting parts

Danger of injury or poisoning.

In case of improper mounting hot, toxic and corrosive process media could be released at the connections.

- Ensure that connecting parts (such as flange gaskets and bolts) are suitable for connection and process media.

- Install the sensor in well-supported pipelines in order to support the weight of the flowmeter.
- Center the connecting pipelines axially in order to assure a stress-free installation. The flowmeter must not be used to bring the rest of the pipework into line; make sure the pipework is correctly aligned before inserting the flow sensor.
- Install two supports or hangers symmetrically and stress-free on the pipeline in close proximity to the process connections.

## Note

### Handling

Never lift the flowmeter using the housing, that is always lift the sensor body.

## Avoid vibrations

- Make sure that any valves or pumps upstream of the sensor do not cavitate and do not send vibrations into the sensor.
- Decouple vibrating pipeline from the flow sensor using flexible tube or couplings.

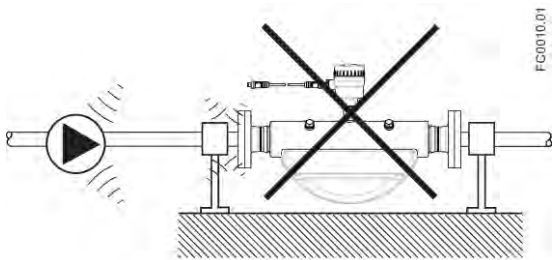

Figure 4-1 Non-flexible pipes not recommended in vibrating environment

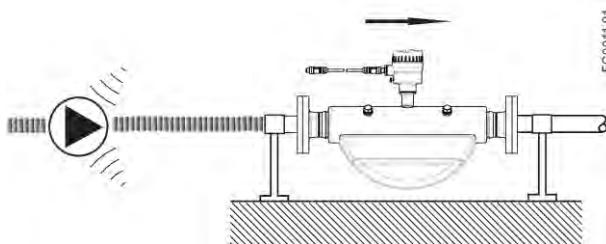

Figure 4-2 Flexible pipes recommended in vibrating environment

## Avoid cross talk

If operating more than one flowmeter in one or multiple interconnected pipelines there is a risk of cross talk.

Prevent cross talk in one of the following ways:

- Mount sensors on separate frames
- Decouple the pipeline using flexible tube or couplings

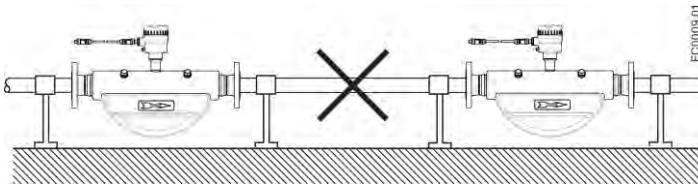

Figure 4-3 High risk of cross talk when using non-flexible pipes

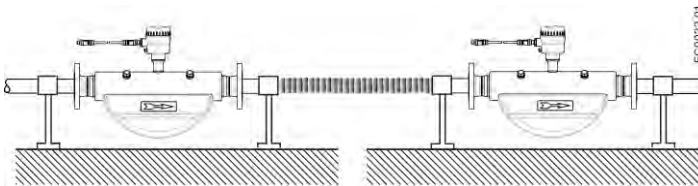

Figure 4-4 Low risk of cross talk when using flexible pipes and separate frames

## Installing the sensor cable

### Wiring sensor and transmitter (M12)

The sensor is provided with a preformed cable terminated with M12 style stainless steel weather-proof plugs.

The cable screen is physically and electrically terminated within the body of the plug.

Take care when handling the cable and passing it through cable ducting that the plug is not subjected to excessive tension (pulling) as the internal connections may be disengaged.

---

#### Note

Never pull the cable by the plug - only by the cable itself.

---

1. Connect sensor using the supplied 4-wire cable with M12 connectors.
- 

#### Note

##### Grounding

The sensor cable screen is mechanically connected to the grounding terminal (PE), only when the M12 plug is correctly tightened.

---

### Wiring sensor and transmitter (glands)

#### A: Preparing cable

Prepare the cable by stripping it at both ends.

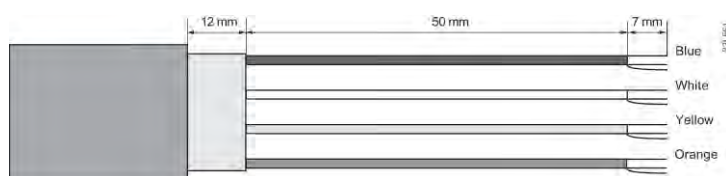

Figure 5-1 Cable end

**B: Connecting at transmitter**

1. Remove lock screw and remove lid.
2. Remove one of the blind plugs and fit cable gland.
3. Remove cap and ferrule from cable gland and slide onto cable.
4. Push cable through open gland; anchor cable screen and wires with clamp bar.
5. Connect wires to terminals according to list below.

Terminal number	Description	Wire color (Siemens)
1	+15 VDC	Orange
2	0 VDC	Yellow
3	B	White
4	A	Blue



6. Assemble and tighten cable gland.
7. Remove o-ring from lid.
8. Reinstall lid and screw in until mechanical stop. Wind back lid by one turn.
9. Mount o-ring by pulling it over the lid and tighten lid until you feel friction from the o-ring on both sides. Wind lid by one quarter of a turn to seal on the o-ring.
10. Reinstall and tighten lid lock screw

**C: Connecting at sensor DSL**

1. Remove lock screw and remove DSL lid.
2. Undo the flexible strap.
3. Disconnect sensor connection from DSL cassette.
4. Loosen mounting screw using a TX10 Torx driver and remove DSL cassette from housing.
5. Remove cap and ferrule from cable gland and slide onto cable.
6. Push cable through open gland; anchor cable screen and wires with clamp bar.
7. Remove terminal block from DSL cassette.
8. Connect wires to terminals according to list below.

Terminal number	Description	Wire color (Siemens)
1	+15 VDC	Orange
2	0 VDC	Yellow
3	B	White
4	A	Blue

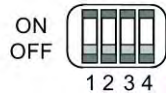

9. Ensure the DIP switches are all set to OFF.
10. Reinstall DSL cassette including mounting screw.
11. Connect sensor connection and sensor cable.
12. Restore flexible strap around all wires.



13. Assemble and tighten cable gland.
14. Remove o-ring from DSL lid.
15. Reinstall lid and screw in until mechanical stop. Wind back lid by one turn.
16. Mount o-ring by pulling it over the DSL lid and tighten lid until you feel friction from the o-ring on both sides. Wind lid by one quarter of a turn to seal on the o-ring.
17. Reinstall and tighten lid lock screw.

Siemens AG  
Industry Sector  
Postfach 48 48  
90026 NÜRNBERG

SITRANS FCS400 sensor  
A5E03649755, 12/2013