

4½ DIGIT PROCESS PANEL METER

MODEL PD690



- 4-20 mA, 0-5 V, 0-10 V inputs
- NEMA 4X, IP65 front panel
- 0.56" (14.2 mm) red LED display
- 4½ digits + extra zero
- 11-point linearization
- Square root function
- 115 VAC or 230 VAC power
- 24 V transmitter power supply standard
- 2 or 4 relays + 4-20 mA output options

GENERAL FEATURES

The Model PD690 puts the power of microprocessor technology to work in a high performance, easy to use, industrial grade digital process meter with the features customers want:

- Isolated 24 V Transmitter Power Supply
- NEMA 4X, IP65 Front Panel
- Steady, Accurate 4½ Digit + Extra Zero Display
- Linearization with Square Root Extraction
- Powerful Options



Single Button Scaling Makes Setup a Snap

Single Button scaling means the PD690 can be completely programmed using only one button. And you only do one thing with that one button: press it once when the meter displays what you want. For example, press the ENTER button to initiate automatic scan of the various programming routines: *SCALE*, *dEC Pt*, *ALAR-5*, *outPut*, and *no Pt5*. To enter one of these routines, press the ENTER button as the routine name is displayed. Once in the routine, press the ENTER button when the meter reads the desired value. It's that simple!

Stand Alone Scaling for Quick Setup

The PD690 may be calibrated using an external signal source such as a calibrator or scaled using the internal source with the Stand Alone Scaling feature. With Stand Alone Scaling, a 4-20 mA input can be scaled for any display range without applying a signal. No calibrator is necessary to program the unit for a desired display range. Simply select Internal Calibration mode and set desired display for the 4 mA and 20 mA values. To scale inputs such as 0-5 V, 1-5 V, or 0-10 V without applying a signal it is necessary to first complete an Initial Calibration.

Simplify Loops with PD690 24 V Transmitter Power Supply

The PD690 is ideal for loops that consist of a transmitter and a digital display because the PD690 provides the 24 V to power the transmitter. This standard feature saves time and money by simplifying wiring and eliminating the cost of an external power supply. In addition, the isolated power supply can be used to power 3 and 4 wire transducers with either current or voltage output.

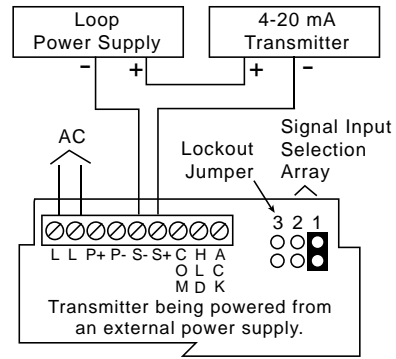

NEMA 4X, IP65 Front Panel Protection for Hostile Environments

Wet, dirty and dusty environment don't bother the PD690 NEMA 4X, IP65 front panel so it can be installed in almost any panel in the plant. That means plant operators can have the important process information right where they need it most, on the shop floor. And the NEMA 4X, IP65 front panel does not restrict access to the setup buttons.

Big Bright Steady Display for Big Numbers

The PD690 4½ digit plus extra zero display is great for displaying big numbers; like the volume in a 100,000 gallon tank. And the PD690 large display does not sacrifice stability for resolution. Even when displaying large numbers, the PD690 display is steady and quick responding. Operators will appreciate being able to display process variables with such stability and resolution and they'll have confidence in the smooth, steady display.

4 Visual Alarm Points Standard

The PD690 comes with 4 visual independent alarms. Each alarm is easily programmed for high or low set point and 0-100% deadband. Front panel LEDs indicate alarm status and assist in set point/reset point programming. Options are available with 2 and 4 relays.

Alarm/Relay Programming

Pressing the ENTER button when the display reads *ALAR-5* initiates a scan of the alarm set and reset points. First, the display flashes Alarm #1 Set Point and indicates this by lighting up the #1 LED and the "S" LED.

(continued on page 3)

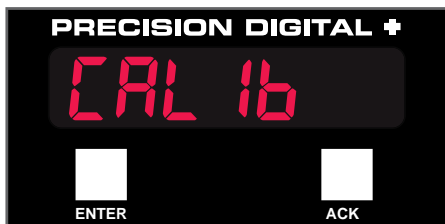

To Calibrate: Press **ENTER** when meter reads *CAL 16*.



To Program Alarms: Press **ENTER** when meter reads *ALAR-5*.

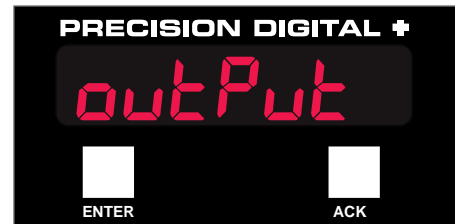

To Program 4-20 mA Output: Press **ENTER** when meter reads *outPut*.

This Set Point may be changed using the ENTER button. Next the display flashes Alarm #1 Reset Point and indicates this by lighting up the #1 LED and the "R" LED. This Reset Point may also be changed using the ENTER button. The remaining Set and Reset Points are programmed in a similar fashion.

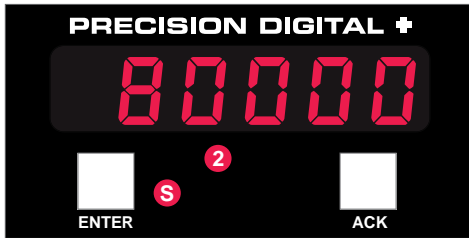

PD690 Alarm #2 Set Point is adjusted to 80000.

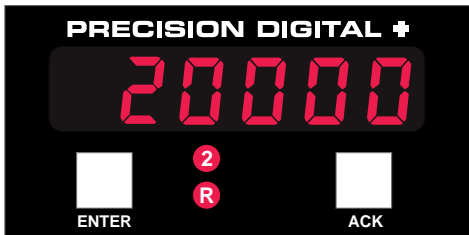

PD690 Alarm #2 Reset Point is adjusted to 20000.

Alarm Status Indication

When an alarm occurs, an LED will illuminate to indicate which alarm has tripped. This LED will stay illuminated until the meter returns to the non-alarm state.



PD690 indicating that Alarm #2 is in alarm condition.

Linearization Feature

The linearization feature has two modes of operation. The 11-point user calibration will display non-linear signals like volume in a round horizontal tank by allowing the user to input up to 11 calibration points and corresponding displays. The square root extraction feature displays flow rate by extracting the square root of a signal from a differential pressure transmitter. This feature also has a user selectable low-flow cutoff feature to give a reading of zero when the flow rate drops below a user-set point.

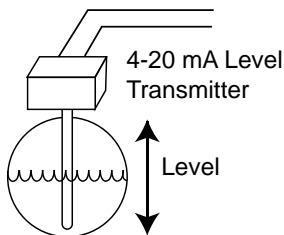

The PD690 can be used to display volume in a round horizontal tank.

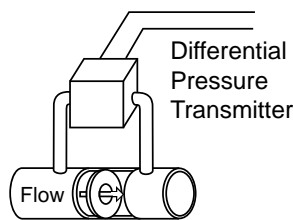

The PD690 can display flow rate by extracting the square root of a signal from a differential pressure transmitter.

OPTIONS

The PD690's wide array of options satisfy even the most demanding applications. And, unlike many competitors, there are no restrictions on the combination of options a meter can have! A fully loaded Model PD690-3-18 has a 24 V transmitter power supply (standard), NEMA 4X front panel (standard), 11-point linearization (standard), 4 relays, and isolated 4-20 mA output.

Relay Options

The PD690 is available with 2 or 4 relays. The SPDT relays are rated 2 amp at 250 VAC and can be programmed for automatic or automatic plus manual reset. The relays can also be programmed for 0-100% deadband.

Isolated 4-20 mA Output Option

Equipped with an isolated 4-20 mA output signal option, these meters can be programmed to produce a 4-20 mA output for virtually any input. The 4-20 mA output signal can be powered either by the internal or an external power supply. If the internal power supply is used for the 4-20 mA output, it is not available to power the transmitter input. The 4-20 mA output provides 500 VDC or peak AC, input-to-output or input/output-to-power isolation.

Option Card Pin-Outs

Pin:	Function:		
J1	1 Transmitter +] PD175	
	2 Transmitter -		
J2	1 Relay #1 Common] PD176	
	2 Relay #1 NC		
	3 Relay #1 NO] PD174	
	4 Relay #2 Common		
	5 Relay #2 NC] PD178
	6 Relay #2 NO		
J3	1 Relay #3 Common] PD177	
	2 Relay #3 NC		
	3 Relay #3 NO] PD177	
	4 Relay #4 Common		
	5 Relay #4 NC		
	6 Relay #4 NO		

Notes:

1. Alarm acknowledgement terminals (ACK and COM) are located on the meter main board.
2. In the alarm condition, the NC contact is connected to common in the fail-safe mode.

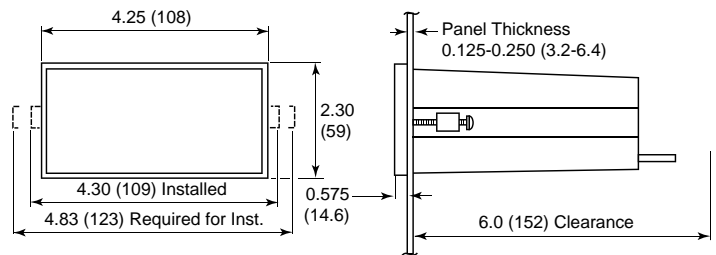

Notes:

1. Panel cutout required: 1.772" x 3.622" (45 mm x 92 mm) 1/8 DIN
2. Panel thickness: 0.125" - 0.250" (3.2 mm - 6.4 mm)
3. Clearance: allow 6 inches (152 mm) behind the panel

SPECIFICATIONS

Except where noted all specifications apply to operation at +25°C.

General

Inputs: Field selectable: 4-20 mA, 0-5 V, 1-5 V, 0-10 V
Display: 0.56" (14.2 mm) red LED; 4½ digits + extra zero; ±19999(0), (0) may be switched on to display 199,990
Linear Input Accuracy: ±0.05% FS ±1 count
Square Root Accuracy: ±0.1% FS ±2 counts
Multi-Point Linearization: 2 to 11 points
Front Panel: NEMA 4X, IP65; panel gasket provided
Calibration: May be scaled using internal calibration (I-RL) or calibrated by applying an external calibration signal (E-RL). To scale inputs such as 0-5 V, 1-5 V, or 0-10 V without applying a signal it is necessary to first complete an Initial Calibration.
Calibration Range: User programmable over entire range of meter
Input Impedance: Voltage ranges: greater than 300 kΩ; Current range: 100-120 Ω, varies with resettable fuse impedance
Input Overload: Protected by automatically resettable fuse
Non-Volatile Memory: Settings stored for a minimum of 10 years.
Lockout: Jumper 3 restricts modification of programmed settings.
Transmitter Supply: Isolated 24 VDC ±5% @ 20 mA; maximum loop resistance: 1200 Ω. Available for either input transmitter or 4-20 mA output option, but not both.
Hold Reading: Connect terminals HLD and COM
Power Options: 115 VAC ±10% or 230 VAC ±10%, 50/60 Hz, 10 VA
Isolation: 1500 VAC
Normal Mode Rejection: 64 dB at 50/60 Hz
Operating Temperature: 0 to 60°C
Storage Temperature: -40 to 85°C
Relative Humidity: 0 to 90% non-condensing
Enclosure: 1/8 DIN, high impact plastic, UL 94V-0, color: black
Weight: 19.7 oz (559 g) (including options)
Connections: Removable screw terminals accept 12 to 22 AWG
Alarm Points: 4, any combination of high or low alarms
Alarm Status Indication: Front panel LED
Alarm Deadband: 0-100%, user selectable
UL File Number: E160849; 508 Industrial Control Equipment
Warranty: 2 years parts & labor

Relays

Rating: 2 or 4 Form C (SPDT); rated 2 A @ 30 VDC or 2 A @ 250 VAC resistive load; 1/14 HP @ 125/250 VAC inductive loads

Reset: User selectable

1. Automatic when the input passes the reset point.
2. Automatic plus manual (via user supplied switch or front panel ACK button). Manual reset resets all manually resettable relays.

ORDERING INFORMATION

115 VAC Model	230 VAC Model	Options Installed	Option Card**
PD690-3-N*	PD690-4-N	None	
PD690-3-14*	PD690-4-14	2 Relays	PD174
PD690-3-15*	PD690-4-15	4-20 mA Output	PD175
PD690-3-16*	PD690-4-16	2 Relays & 4-20 mA Output	PD176
PD690-3-17*	PD690-4-17	4 Relays	PD177
PD690-3-18*	PD690-4-18	4 Relays & 4-20 mA Output	PD178

*Quick Shipment Program product, shipped within 2 working days.

**Part numbers for Option Cards when purchased separately.

Listed models include the corresponding described option.

Fail-Safe Operation: Relay coils are energized in non-alarm condition. In case of power failure, relays will go to alarm state. To disable fail-safe operation remove jumper JP6 located on the display board.

Auto Initialization: When power is applied to the meter, the relays will always reflect the state of the input to the meter.

Deadband: 0-100%, user selectable

Isolated 4-20 mA Transmitter Output

Scaling Range: Anywhere in range of meter, 501 count minimum span; reverse scaling allowed.

Accuracy: ±0.1% FS ±0.004 mA

Output Loop Resistance:

Power supply	Loop Resistance	
	Minimum	Maximum
24 VDC	10 Ω	600 Ω
35 VDC (external)	600 Ω	1000 Ω

Isolation: 500 V input-to-output or input/output-to-24 VDC supply

External Loop Power Supply: 35 VDC maximum

Simplify Loops with PD690's 24 V Transmitter Power Supply

The PD690 is ideal for loops that consist of a transmitter and a digital display because the PD690 provides the 24 V to power the transmitter. This standard feature saves time and money by simplifying wiring and eliminating the cost of an external power supply. In addition, the isolated power supply can be used to power 3-wire and 4-wire transducers with either current or voltage output.

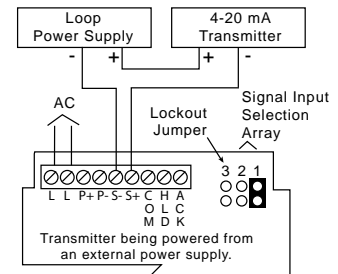
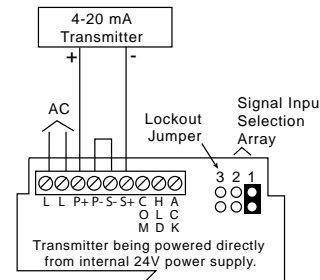

YOUR LOCAL DISTRIBUTOR IS:

LDS690_C 07/06