

SABRE P MODEL PD603 PROCESS METER

Instruction Manual



Sabre Series

- 0-20, 4-20 mA, 0-5, 1-5, 0-10, ± 10 V Inputs
- Type 4X, NEMA 4X, IP65 Front
- Shallow Depth Case 3.6" Behind Panel
- 4 Digit Display, 0.56" (14 mm) High, Red LEDs
- Easy Front Panel Programming
- Scale without a Signal Source
- Calibrate with a Signal Source
- Maximum/Minimum Display
- Universal Power Supply 85-265 VAC
- 12-36 VDC/12-24 VAC Power Option
- 24 VDC @ 200 mA Transmitter Supply Option

PRECISION DIGITAL CORPORATION
233 South Street • Hopkinton MA 01748 USA
Tel (800) 343-1001 • Fax (508) 655-8990

**PRECISION
DIGITAL**

www.predig.com

Disclaimer

The information contained in this document is subject to change without notice. Precision Digital makes no representations or warranties with respect to the contents hereof, and specifically disclaims any implied warranties of merchantability or fitness for a particular purpose.

© 2010-2016 Precision Digital Corporation. All rights reserved.

INTRODUCTION

The Sabre P model PD603 is an easy to use process input meter. It accepts 0-20 mA, 4-20 mA, 0-5, 1-5, or ± 10 V input signals. The four front panel buttons make the setup and programming an easy task.

The isolated 24 VDC transmitter power (optional) can be used to power the input transmitter or other devices.

ORDERING INFORMATION

85-265 VAC* Model	12-36 VDC* Model	Description
PD603-6R0-0	PD603-7R0-0	Process Meter
PD603-6R0-1		Process Meter with 24 V transmitter supply

*All models may be powered from AC or DC, see **Specifications** for details.

NEMA 4 & NEMA 4X Enclosures

Model	# of Meters	Description	Mounting
PDA2500	1 - 6	Plastic NEMA 4X Enclosure	Through Door
PDA2600	1 - 6	Stainless Steel NEMA 4X Enclosure	Through Door
PDA2700	1 - 6	Steel NEMA 4 Enclosure	Through Door
PDA2801	1	Plastic NEMA 4X Enclosure	Through Cover

Table of Contents

INTRODUCTION -----	2
ORDERING INFORMATION -----	2
SPECIFICATIONS -----	5
General-----	5
Process Input-----	6
COMPLIANCE INFORMATION -----	7
Safety-----	7
Electromagnetic Compatibility-----	7
SAFETY INFORMATION -----	8
INSTALLATION -----	9
Unpacking-----	9
Panel Mounting-----	9
Connections-----	10
Connector Labeling-----	10
Power Connections-----	10
Signal Connections-----	11
SETUP AND PROGRAMMING -----	13
Front Panel Buttons and Status LED Indicators-----	14
Display Functions and Messages-----	15
Main Menu-----	16
Setting Numeric Values-----	17
Setting Up the Meter (<i>SETU</i>)-----	18
Setting the Input Signal (<i>INPT</i>)-----	18
Setting the Decimal Point (<i>DEC.P</i>)-----	19
Programming the Meter (<i>PRG</i>)-----	20
Scaling the Meter (<i>SCALE</i>)-----	21
Calibrating the Meter (<i>CAL</i>)-----	23
Setting Up the Password (<i>PR55</i>)-----	24
Locking the Meter-----	24
Unlocking the Meter-----	24
OPERATION -----	26
Front Panel Buttons Operation-----	26
Maximum/Minimum Readings-----	27
MOUNTING DIMENSIONS -----	28
TROUBLESHOOTING -----	29

Troubleshooting Tips	29
QUICK USER INTERFACE REFERENCE GUIDE	30
EU DECLARATION OF CONFORMITY	31

Table of Figures

Figure 1. Panel Cutout and Mounting	9
Figure 2. Connector Labeling - Meter with 24 V Supply	10
Figure 3. Power Connections	10
Figure 4. Transmitter Powered by Ext. Supply or Self-Powered	11
Figure 5. Transmitters Powered by Internal Supply (Optional)	11
Figure 6. Voltage Input Connections	12
Figure 7. Meter Dimensions - Side View	28
Figure 8. Case Dimensions - Top View	28

SPECIFICATIONS

Except where noted all specifications apply to operation at +25°C.

General

DISPLAY	0.56" (14 mm) high, red LED Four digits (-1999 to 9999), automatic lead zero blanking.
DISPLAY UPDATE RATE	5/second
OVERRANGE	Display flashes 9999
UNDERRANGE	Display flashes - 1999
PROGRAMMING METHODS	Four front panel buttons
RECALIBRATION	All ranges are calibrated at the factory. Recalibration is recommended at least every 12 months.
MAX/MIN DISPLAY	Max/min readings reached by the process are stored until reset by the user or until power to the meter is turned off.
PASSWORD	Programmable password restricts modification of programmed settings.
NON-VOLATILE MEMORY	All programmed settings are stored in non-volatile memory for a minimum of ten years if power is lost.
POWER OPTIONS	85-265 VAC, 50/60 Hz; 90-265 VDC, 20 W max or 12-36 VDC, 12-24 VAC, 6 W max
FUSE	Required fuse: UL Recognized, 5 A max, slow blow Up to 6 meters may share one 5 A fuse
ISOLATED TRANSMITTER POWER SUPPLY	P+, P- terminals: 24 VDC \pm 10% @ 200 mA max
NORMAL MODE REJECTION	64 dB at 50/60 Hz
ISOLATION	4 kV input-to-power line 500 V input-to-24 V supply
OVERVOLTAGE CATEGORY	Installation Overvoltage Category II: Local level with smaller transient overvoltages than Installation Overvoltage Category III.
ENVIRONMENTAL	Operating temperature range: 0 to 65°C Storage temperature range: -40 to 85°C Relative humidity: 0 to 90% non-condensing
CONNECTIONS	Removable screw terminal blocks accept 12 to 22 AWG wire, RJ11 for factory use only.

ENCLOSURE	1/8 DIN, high impact plastic, UL 94V-0, color: gray
MOUNTING	1/8 DIN panel cutout required. Two panel mounting bracket assemblies provided
TIGHTENING TORQUE	Screw terminal connectors: 5 lb-in (0.56 Nm)
OVERALL DIMENSIONS	2.45" x 4.68" x 4.19" (62 mm x 119 mm x 106 mm) (H x W x D)
WEIGHT	8.5 oz (241 g)
WARRANTY	1 year parts & labor
EXTENDED WARRANTY	1 or 2 years, refer to the Price List for details.

Process Input

INPUTS	Field selectable: 0-20, 4-20 mA, 0-5, 1-5, 0-10 V, or ± 10 V						
ACCURACY	$\pm 0.05\%$ FS ± 1 count						
FUNCTION	Linear						
TEMPERATURE DRIFT	50 PPM/ $^{\circ}$ C from 0 to 65 $^{\circ}$ C ambient						
DECIMAL POINT	Up to three decimal places: <i>d.ddd, dd.dd, dddd.d, or dddd</i>						
CALIBRATION RANGE	An <i>Error</i> message will appear if input 1 and input 2 signals are too close together. <table border="0"> <thead> <tr> <th>Input Range</th> <th>Minimum Span Input 1 & Input 2</th> </tr> </thead> <tbody> <tr> <td>4-20 mA</td> <td>0.40 mA</td> </tr> <tr> <td>± 10 V</td> <td>0.20 V</td> </tr> </tbody> </table>	Input Range	Minimum Span Input 1 & Input 2	4-20 mA	0.40 mA	± 10 V	0.20 V
Input Range	Minimum Span Input 1 & Input 2						
4-20 mA	0.40 mA						
± 10 V	0.20 V						
INPUT IMPEDANCE	Voltage ranges: greater than 1 M Ω Current ranges: 50 - 100 Ω (depending on resettable fuse impedance)						
INPUT OVERLOAD	Current input protected by resettable fuse. Fuse resets automatically after fault is removed.						

COMPLIANCE INFORMATION**Safety**

UL LISTED	USA and Canada UL 508 Industrial Control Equipment
UL FILE NUMBER	E160849
FRONT PANEL	UL Type 4X, NEMA 4X, IP65; panel gasket provided
LOW VOLTAGE DIRECTIVE	EN 61010-1:2010 Safety requirements for measurement, control, and laboratory use

Electromagnetic Compatibility

EMISSIONS	EN 55011:2009+A1:2010 Group 1 Class A ISM emissions requirements
Radiated Emissions	Class A
AC Mains Conducted Emissions	Class A
IMMUNITY	EN 61326-1:2013 Measurement, control, and laboratory equipment EN 61000-6-2:2005 EMC heavy industrial generic immunity standard
RFI - Amplitude Modulated	80 -1000 MHz 10 V/m 80% AM (1 kHz) 1.4 - 2.0 GHz 3 V/m 80% AM (1 kHz) 2.0 - 2.7 GHz 1 V/m 80% AM (1 kHz)
Electrical Fast Transients	±2kV AC mains, ±1kV other
Electrostatic Discharge	±4kV contact, ±8kV air
RFI - Conducted	10V, 0.15-80 MHz, 1kHz 80% AM
AC Surge	±2kV Common, ±1kV Differential
Surge	1KV (CM)
Power-Frequency Magnetic Field	30 A/m 70%V for 0.5 period
Voltage Dips	40%V for 5 & 50 periods 70%V for 25 periods
Voltage Interruptions	<5%V for 250 periods

Note:

Testing was conducted on PD603 meters installed through the covers of grounded metal enclosures with cable shields grounded at the point of entry representing installations designed to optimize EMC performance.

Declaration of Conformity available at www.predig.com

SAFETY INFORMATION

CAUTION: Read complete instructions prior to installation and operation of the meter.



WARNING: Risk of electric shock.

**WARNING**

Hazardous voltages exist within enclosure. Installation and service should be performed only by trained service personnel.

INSTALLATION

There is no need to remove the meter from its case to complete the installation, wiring, and setup of the meter.

Unpacking

Remove the meter from box. Inspect the packaging and contents for damage. Report damages, if any, to the carrier.

If any part is missing or the meter malfunctions, please contact your supplier or the factory for assistance.

Panel Mounting

- Prepare a standard 1/8 DIN panel cutout – 3.622" x 1.772" (92 mm x 45 mm). Refer to *Mounting Dimensions*, page 28 for more details.
- Clearance: allow at least 4" (102 mm) behind the panel for wiring.
- Panel thickness: 0.04" - 0.25" (1.0 mm - 6.4 mm).
Recommended minimum panel thickness to maintain Type 4X rating: 0.06" (1.5 mm) steel panel, 0.16" (4.1 mm) plastic panel.
- Remove the two mounting brackets provided with the meter (back-off the two screws so that there is ¼" (6.4 mm) or less through the bracket. Slide the bracket toward the front of the case and remove).
- Insert meter into the panel cutout.
- Install mounting brackets and tighten the screws against the panel. To achieve a proper seal, tighten the mounting bracket screws evenly until meter is snug to the panel along its short side. **DO NOT OVER TIGHTEN**, as the rear of the panel may be damaged.

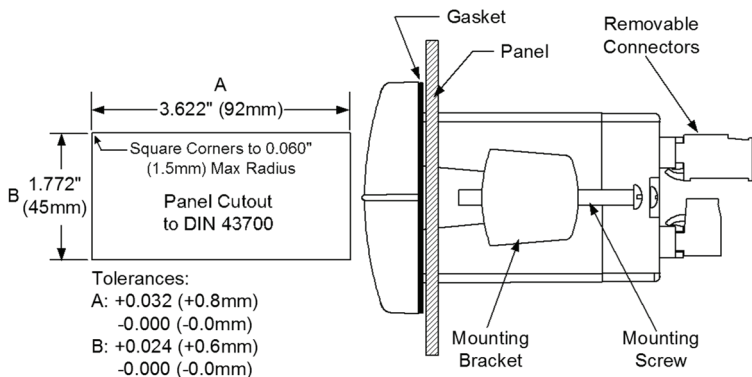

Figure 1. Panel Cutout and Mounting

Connections

All connections are made to removable screw terminal connectors located at the rear of the meter.



Use copper wire with 60°C or 60/75°C insulation for all line voltage connections. Observe all safety regulations. Electrical wiring should be performed in accordance with all applicable national, state, and local codes to prevent damage to the meter and ensure personnel safety.

Connector Labeling

The connectors label, affixed to the meter, shows the location of the connectors available with requested configuration.

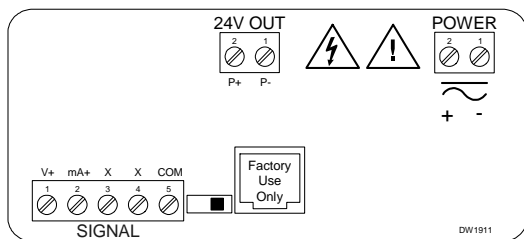

Figure 2. Connector Labeling - Meter with 24 V Supply

Power Connections

Power connections are made to a two-terminal connector labeled POWER on Figure 2. The meter will operate regardless of DC polarity connection. The + and - symbols are only a suggested wiring convention.

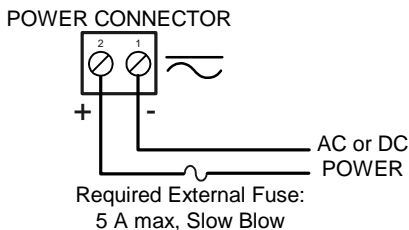

Figure 3. Power Connections

Signal Connections

Signal connections are made to a five-terminal connector labeled SIGNAL on Figure 2. The COM (common) terminal is the return for all types of input signals.

Current and Voltage Connections

The following figures show examples for current and voltage connections. There are no switches or jumpers to set up for current and voltage inputs. Setup and programming is performed through the front panel buttons.

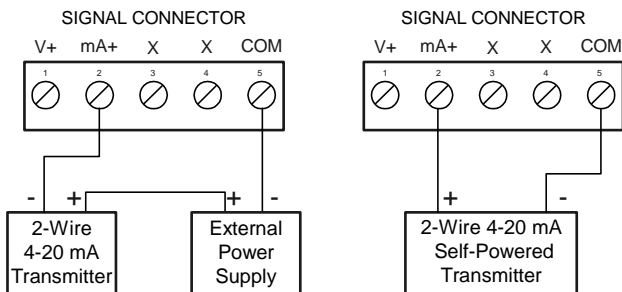

Figure 4. Transmitter Powered by Ext. Supply or Self-Powered

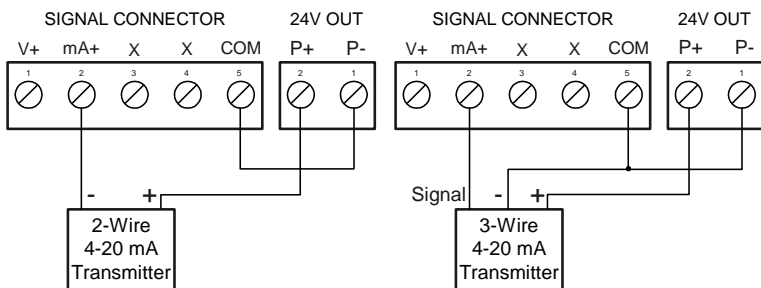

Figure 5. Transmitters Powered by Internal Supply (Optional)

The current input is protected against current overload by a resettable fuse. The display may or may not show a fault condition depending on the nature of the overload.

The fuse limits the current to a safe level when it detects a fault condition, and automatically resets itself when the fault condition is removed.

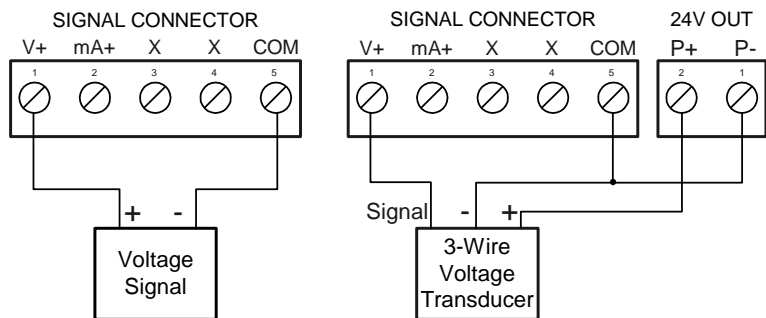

Figure 6. Voltage Input Connections

The meter is capable of accepting any voltage from -10 VDC to +10 VDC.

SETUP AND PROGRAMMING

- There is **no need to recalibrate** the meter when first received from the factory.
- The meter is **factory calibrated** prior to shipment, for all input types, in milliamps and volts. The calibration equipment is certified to NIST standards.

Overview





There are no jumpers involved in the setup process of the meter. The switch, located between the SIGNAL and the RJ11 connectors is not used with the PD603 model. Setup and programming is done through the front panel buttons.

After power and signal connections have been completed and verified, apply power to the meter.

For
Quick User Interface Reference Guide
go to page 30

Front Panel Buttons and Status LED Indicators



Button Symbol	Description
	Menu
	Right arrow/Reset
	Up arrow/Max
	Enter/Ack

- Press the **Menu** button to enter or exit the Programming Mode at any time.
- Press the **Right** arrow button to move to the next digit during digit programming.
- Press the **Up** arrow button to scroll through the menus, decimal point, or to increment the value of a digit.
- Press the **Enter/Ack** button to access a menu or to accept a setting.

Display Functions and Messages

The meter displays various functions and messages during setup/programming and operation. The following table shows the displayed functions and messages with their action/setting description.

Display	Parameter	Action/Setting
SEtU	Setup	Enter Setup menu
inPt	Input	Enter Input menu
4-20	4-20 mA	Set meter for 4-20 mA input
0-10	0-10 VDC	Set meter for ± 10 VDC input
dEc.P	Decimal point	Set decimal point for process inputs
PrOG	Program	Enter the Program menu
ScAL	Scale	Enter the Scale menu
CaLi	Calibrate	Enter the Calibrate menu
inP 1	Input 1	Calibrate input 1 signal or program input 1 value
d 1 1	Display 1	Program display 1 value
inP 2	Input 2	Calibrate input 2 signal or program input 2 value
d 1 2	Display 2	Program display 2 value
Err	Error	Error, calibration not successful, check signal
PRSS	Password	Enter the Password menu
unLc	Unlocked	Program password to lock meter
LoCd	Locked	Enter password to unlock meter
9999 - 1999	Flashing display	Overrange condition Underrange condition

Main Menu

The main menu consists of the following functions: *Setup*, *Program*, and *Password*.

- Press **Menu** button to enter Programming Mode then press **Up** arrow button to scroll main menu.

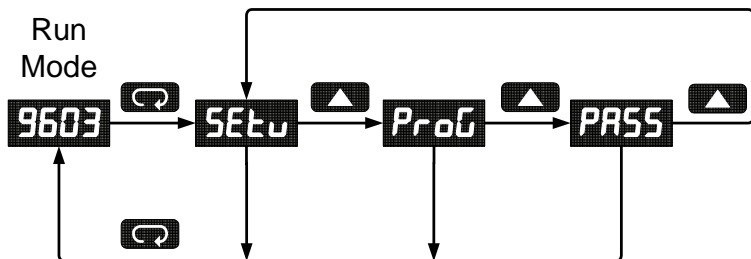

- Press **Menu**, at any time, to exit and return to Run Mode. Changes made to settings prior to pressing **Enter/Ack** are not saved.
- Changes to the settings are saved to memory only after pressing **Enter/Ack**.
- The display moves to the next menu every time a setting is accepted by pressing **Enter/Ack**.

Setting Numeric Values

The numeric values are set using the **Right** and **Up** arrow buttons. Press **Right** arrow to select next digit and **Up** arrow to increment digit value.

The digit being changed is displayed brighter than the rest.

Press the **Enter/Ack** button, at any time, to accept a setting or **Menu** button to exit without saving changes.

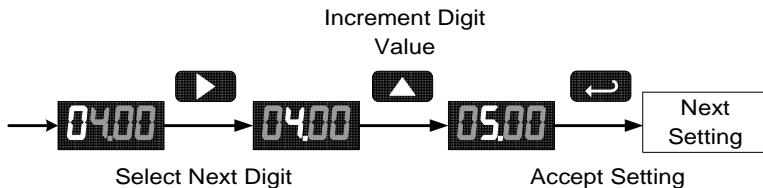

The decimal point is set using the **Up** arrow button in the *Setup-decimal point* menu.

Setting Up the Meter (SEtU)

The *Setup* menu is used to select:

1. Input signal the meter will accept
2. Decimal point position

Press the **Enter/Ack** button to access any menu or press **Up** arrow button to scroll through choices. Press the **Menu** button to exit at any time.

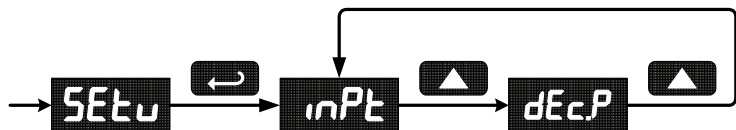

Setting the Input Signal (inPt)

Enter the *Input* menu to set up the meter to display current (4-20) or voltage (0-10) inputs.

The voltage input is capable of accepting any signal from -10 to +10 VDC. Select voltage input to accept 0-5, 1-5, 0-10, or ± 10 VDC signals.

The current input is capable of accepting any signal from -20 to 20 mA. Select current input to accept 0-20 or 4-20 mA signals.

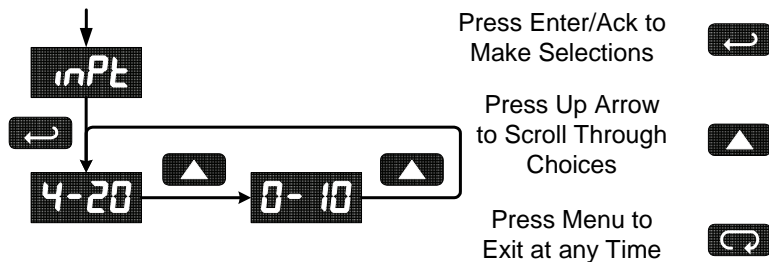

Setting the Decimal Point (*dEcP*)

Decimal point may be set with up to three decimal places or with no decimal point at all.

Pressing the **Up** arrow moves the decimal point one place to the right until no decimal point is displayed, then it moves to the leftmost position.

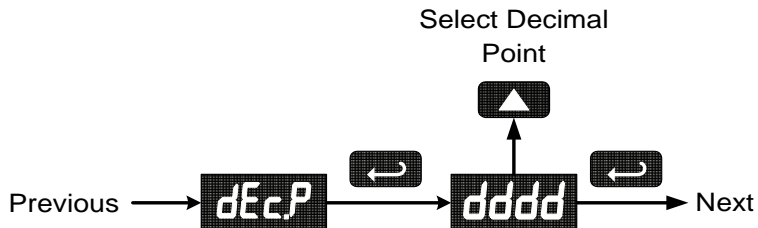

Programming the Meter (*Prog*)

It is **very important** to read the following information, before proceeding to program the meter:

- There is **no need to recalibrate** the meter when first received from the factory.
- The meter is **factory calibrated** prior to shipment, for all input types, in milliamps and volts. The calibration equipment is certified to NIST standards.
- Use the *Scale* menu to scale process inputs (e.g. 4-20 mA). A calibrated signal source is not needed to scale the meter.

The *Program* menu contains the *Calibrate* and the *Scale* menus.

Process inputs may be calibrated or scaled to any display within the range of the meter.

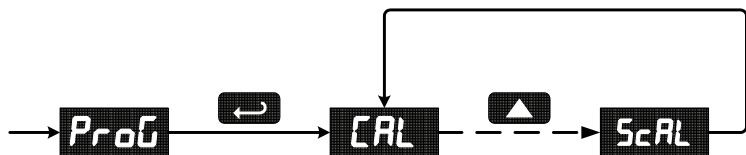

Scaling the Meter (ScAL)

The process inputs (4-20 mA and ± 10 VDC) can be scaled to display the process in engineering units.

A signal source is not needed to scale the meter; simply program the inputs and corresponding display values.

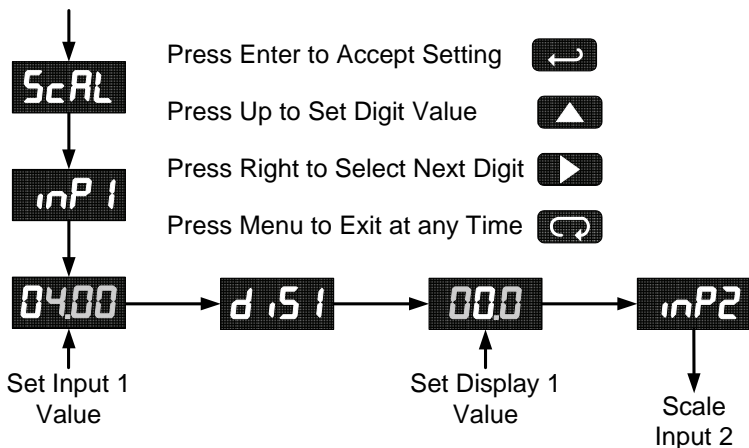

For instructions on how to program numeric values see *Setting Numeric Values*, page 17.

Error Message (Err)

An error message indicates that the calibration or scaling process was not successful.

After the error message is displayed, the meter reverts to input 1, allowing the appropriate input signals to be applied.

The error message might be caused by any of the following conditions:

1. Input signal is not connected to the proper terminals or it is connected backwards.
2. Wrong signal selection in *Setup* menu.
3. Minimum input span requirements not maintained.
4. Input 1 signal inadvertently applied to calibrate input 2.

Minimum Input Span

The minimum input span is the minimum difference between input 1 and input 2 signals required to complete the calibration or scaling of the meter.

Input range	Input 1 & input 2 span
4-20 mA	0.40 mA
±10 VDC	0.20 VDC

Calibrating the Meter (CAL)

To scale the meter without a signal source refer to *Scaling the Meter (ScAL)*, page 21.

The meter can be calibrated to display the process in engineering units by applying the appropriate input signal and following the calibration procedure.

The use of a calibrated signal source is strongly recommended to calibrate the meter.

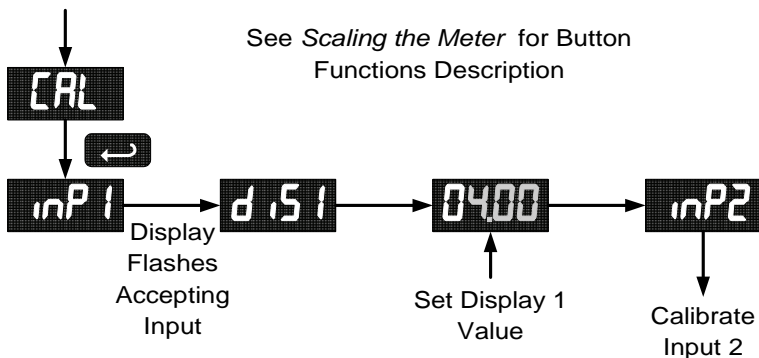

Setting Up the Password (PASS)

The *Password* menu is used to program a four-digit password to prevent unauthorized changes to the programmed parameter settings.

Locking the Meter

Enter the *Password* menu and program a four-digit password.

For instructions on how to program numeric values see *Setting Numeric Values*, page 17.

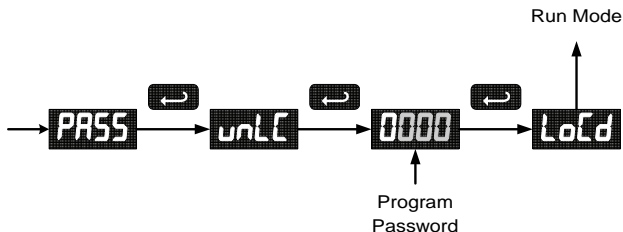

Record the password for future reference. If appropriate, it may be recorded in the space provided.

Model:	
Serial Number:	
Password:	__ __ __ __

Unlocking the Meter

If the meter is password protected, the correct password must be entered in order to make changes to the parameter settings.

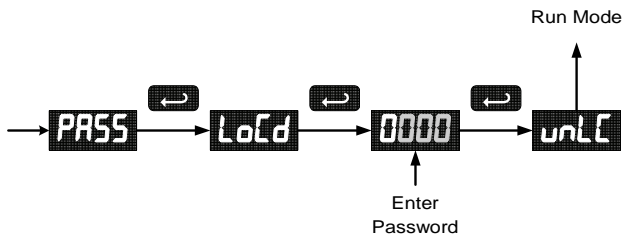

Entering the correct four-digit number sets the password to 0000, disabling the protection.

Changes to the programmed parameter settings are allowed only with the password set to 0000.

If the password entered is incorrect, the meter displays *Ld* (Locked) for about two seconds, then it returns to Run Mode. To try again, press **Enter/Ack** while the *Locked* message is displayed.

Forgot the Password?





The password may be disabled by the following procedure:

1. Note display reading prior to pressing the Menu button. Ignore decimal point and sign.
2. Access the *Password* menu, add 2 to the noted reading and enter that number as the password (e.g. display reading = -1.23, password = 0125).

OPERATION

For process inputs, the meter is capable of accepting positive and negative signals and displaying these signals in engineering units from -1999 to 9999 (e.g. a signal from -10 to +10 VDC could be displayed as -5000 to 5000).

Front Panel Buttons Operation

Button Symbol	Description
	Press to enter or exit Programming Mode, view settings, or exit Max/Min readings
	Press to reset Max/Min readings
	Press to display Max/Min readings alternately
	Press to display Max/Min reading indefinitely while displaying Max/Min

Maximum/Minimum Readings

The main function of the front panel buttons during operation is to display the maximum and minimum readings reached by the process.

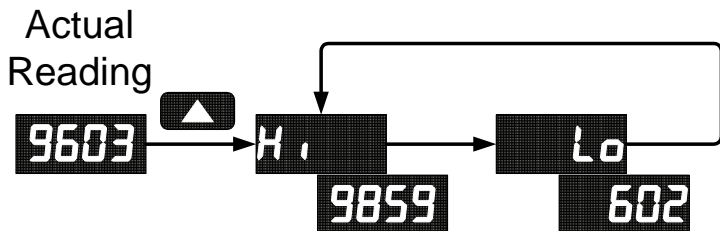

Press **Up** to Display and Toggle Max/Min



Press **Enter** to Hold Max/Min



Press **Right** to Reset Max/Min



Press **Menu** to Exit Max/Min

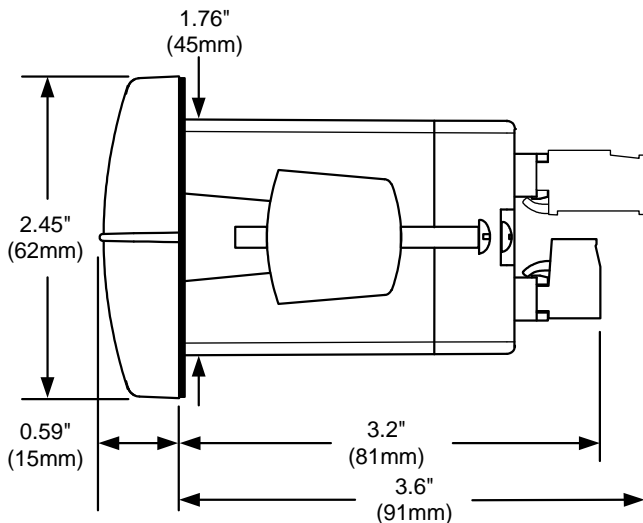
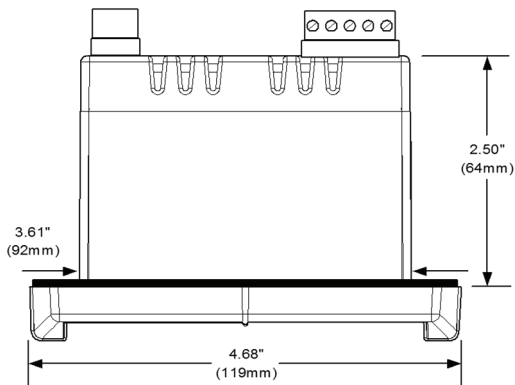

1. Press **Up** arrow/**Max** button to display maximum reading since the last reset/power-up.
2. Press **Up** arrow/**Max** again to display the minimum reading since the last reset/power-up.
3. Press **Enter/Ack** to hold Max/Min display reading, the meter will continue to track new Max/Min readings.
4. If **Enter/Ack** is not pressed, the Max/Min display reading will time out after ten seconds and the meter will return to display the actual reading.
5. Press **Right** arrow/**Reset** button to reset Max/Min while reading is being displayed. Max/Min display readings are reset to actual reading.

MOUNTING DIMENSIONS**Figure 7. Meter Dimensions - Side View****Figure 8. Case Dimensions - Top View**

TROUBLESHOOTING

The rugged design and the user-friendly interface of the meter should make it unusual for the installer or operator to refer to this section of the manual.

Troubleshooting Tips

Symptom	Check/Action
No display at all	Check power at power connector
Not able to change setup or programming, $L o c k$ is displayed	Meter is locked, enter correct four-digit password to unlock
Meter displays error message during calibration ($E r r$)	Check: <ol style="list-style-type: none"> Signal connections Input selected in <i>Setup</i> menu Minimum input span requirements
Meter displays <ul style="list-style-type: none"> • 9999 • -1999 	Check: <ol style="list-style-type: none"> Input selected in <i>Setup</i> menu Corresponding signal at Signal connector
Display alternates between <ol style="list-style-type: none"> $H i$ and a number $L o$ and a number 	Press Menu to exit Max/Min display readings.
If the display locks up or the meter does not respond at all	Cycle the power to restart the microprocessor.
Other symptoms not described above	Call Technical Support for assistance.

QUICK USER INTERFACE REFERENCE GUIDE

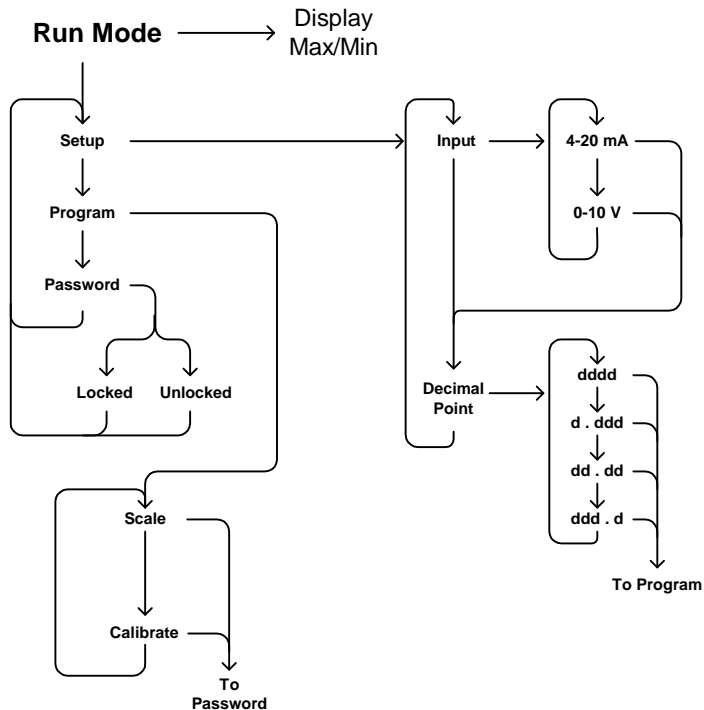

EU DECLARATION OF CONFORMITY

Issued in accordance with ISO/IEC 17050-1:2004.

We,

Precision Digital Corporation
233 South Street
Hopkinton, MA 01748 USA

as the manufacturer, declare under our sole responsibility that the product(s),

Model PD603 Sabre Process Meter

to which this declaration relates, is in conformity with the European Union Directives shown below:

2014/35/EU	Low Voltage Directive
2014/30/EU	EMC Directive
2011/65/EU	RoHS Directive

This conformity is based on compliance with the application of harmonized or applicable technical standards and, when applicable or required, a European Union notified body certification.

Standards:

EN 55011:1998
EN 61000-6-2:2001
EN 61010-1:1995
EN 61326:2006

The standards EN 55011:1998, EN 61000-6-2:2001, EN 61010-1:1995, and EN 61326:2006 are no longer harmonized. The requirements of these standards have been checked against the harmonized standards EN 55011:2009+A1:2010, EN 61000-6-2:2005, EN 61010-1:2010, and EN 61326:2013 and there were no major technical changes affecting the latest technical knowledge for the products listed above.

Product Markings: 

Signed for and on behalf of Precision Digital Corporation:



Name: Jeffrey Peters
Company: Precision Digital Corporation
Title: President
Date: 04/20/2016



Document No: DoC PD603 {042016}

How to Contact Precision Digital

- For Technical Support please
Call: (800) 610-5239 or (508) 655-7300
Fax: (508) 655-8990
Email: support@predig.com
- For Sales Support or to place an order please
Call: (800) 343-1001 or (508) 655-7300
Fax: (508) 655-8990
Email: sales@predig.com
- For the latest version of this manual please visit
www.predig.com

