

PD2-7000

Helios Dual-Line 6-Digit Temperature Meter

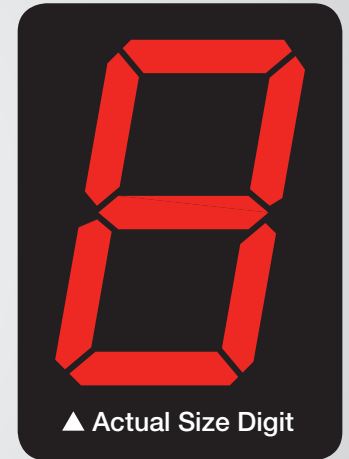

HELIOS



TEMPERATURE

- Large 1.80" Digits
- Dual-Line 6-Digit Display
- Readable from up to 100 Feet (30 Meters) Away
- Superluminous Sunlight Readable Display
- IP65 Rated Field Mountable Enclosure
- Operating Temperature Range of -40 to 65°C (-40 to 150°F)
- J, K, T, E, R, S, B, N, C Thermocouples
- 100 or 1000 Ω Platinum, 10 Ω Copper, 120 Ω Nickel RTDs
- 1° or 0.1° Resolution
- Averages up to 10 RTD Sensors
- Automatic Cold Junction Compensation
- Universal 85-265 VAC, or 12-24 VDC Input Power Models
- Programmable Display & Function Keys
- 2 or 4 Relays + Isolated 4-20 mA Output Options
- Onboard USB & RS-485 Serial Communication Options
- Modbus[®] RTU Communication Protocol Standard
- Program the Meter from a PC with Onboard USB and MeterView[®] Pro

PRECISION DIGITAL CORPORATION

**PRECISION
DIGITAL**
www.predig.com

PD2-7000 Helios Dual-Line 6-Digit Temperature Meter

UV Resistant
Sunlight Readable Display



INTRODUCTION

The Helios PD2-7000 is a multi-purpose, easy to use, large-display digital temperature meter. It features large 1.8 inch superluminous LED digits, which can be read in direct sunlight from up to 100 feet away. It is housed in a water-resistant, field mountable NEMA 4X and IP65 rated enclosure for convenient indoor and outdoor installation.

The meter accepts type J, K, T, E, R, S, B, N, and C thermocouples as well as 100 or 1000 Ω platinum, 10 Ω copper, and 120 Ω nickel RTDs. Three of the programming buttons can be set for custom operation. The meter features automatic cold junction compensation for thermo-couples and can average up to 10 RTD sensors for precision temperature measurement.

A fully loaded Helios PD2-7000 temperature meter comes with four (4) SPDT relays, a 4 20 mA output, two 24 VDC power supplies, five (5) digital inputs and four (4) digital outputs, and RS485 serial communications.

The four relays can be used for alarm indication or temperature control applications. The large display size, ease of readability, Modbus[®] RTU serial communications, and digital I/O features make the Helios an excellent addition to any system.

KEY FEATURES

Precise, Accurate, and More Informative

The Helios' large 1.8" display provides a highly accurate and precise dual line, 6-digit view of temperature measurement in degrees $^{\circ}\text{C}$ or $^{\circ}\text{F}$ and the lower display can also provide a clearly identifiable custom tag. Its 24-bit A/D is accurate to $\pm 0.03\%$ of calibrated span ± 1 count.

Configurable

The upper display can be programmed to indicate current temperature, maximum or minimum temperature, alternating maximum/minimum temperatures, one of four alarm set points, or Modbus input. The lower display can also be configured to display engineering units, set points, user defined legends, or simply turned off.

Superluminous Sunlight Readable Display

PD2-7000's standard SunBright display features extraordinarily bright LEDs. It is perfect for applications where the meter is in direct sunlight or in applications where visibility may be impaired by smoke, fog, dust, or distance.

Function Keys

There are three function keys available to the user. These keys can be programmed to trigger certain events (i.e. acknowledge alarms, reset max and/or min, disable/enable output relays, or hold current relay states), provide direct menu access points, and more.

Easy to Program

The user friendly dual-line display makes the Helios easy to set up & program with its programming buttons located behind the front door panel. There are three levels of password protection to help maintain the integrity of the programming and there are no jumpers to set for the meter input selection.



Input Setup



Display Setup

PD2-7000 Helios Dual-Line 6-Digit Temperature Meter

Three Tier Password Protection

The Helios offers 3 levels of password protection:

- Level 1 protection allows the operator use of only the 3 pre-configured function keys on the front panel without a password.
- Level 2 protection allows the operator use of only the function keys and the ability to change set points without a password.
- Level 3 protection restricts the operator from using the function keys and all meter configuration menus without a password.

On-Board Digital Input

The PD2-7000 includes a digital input as standard. This digital input can operate with the tare, reset tare, or interlock relays feature, force relays on from a signal from a PLC or relay on other equipment, and much more. This is ideal for installations where the meter is inaccessible behind a cover, or where an additional function key is needed for customized operation.

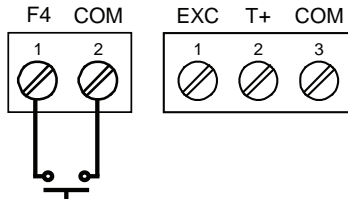

Rounding

The rounding feature is used to give the user a steadier display with fluctuating signals. It causes the display to round to the nearest value according to the rounding value selected (1, 2, 5, or 10). For example, with a rounding value of 10, and a input of 12346, the display would indicate 12350.

Max/Min Display

Max/Min (or Peak/Valley) is standard on the Helios PD2-7000. Either display can be configured to show either maximum or minimum excursion since last reset. The displays can also be configured to toggle between Max and Min values. Both values can be simply reset from the front panel.

Free USB Programming Software

The Helios comes with free **MeterView® Pro** programming software that connects to your PC with a standard USB cable that is provided with each instrument. The software will allow you to configure, monitor, control, and datalog a Helios PD2-7000 using your PC. A new and very useful feature of this software is that it is resident on the Helios meter and installed directly into your PC. This eliminates the need to install drivers or download software from the internet. Just connect the Helios to your PC (the Helios even gets its power from the PC so you don't have to provide external power!) and within minutes you will be programming it with the free software.

METERVIEW® PRO SOFTWARE

Configure, monitor, and datalog a PD2-7000 from a PC using Meter View Pro Software (available with each Helios meter via USB or for download at www.predig.com).

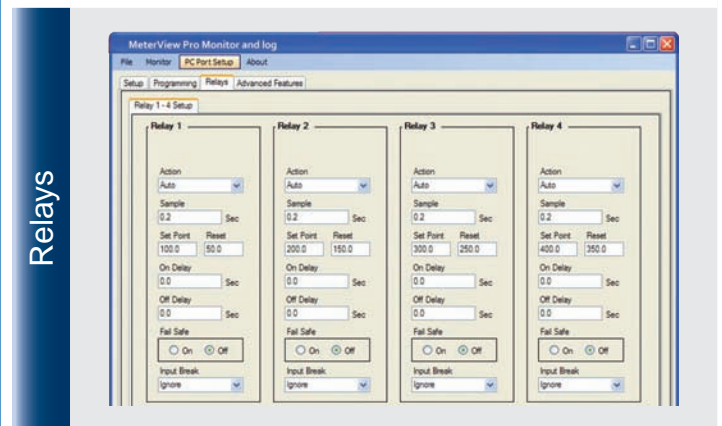
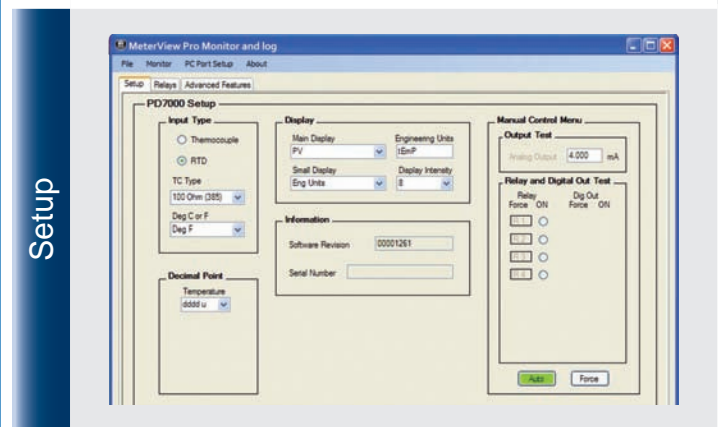
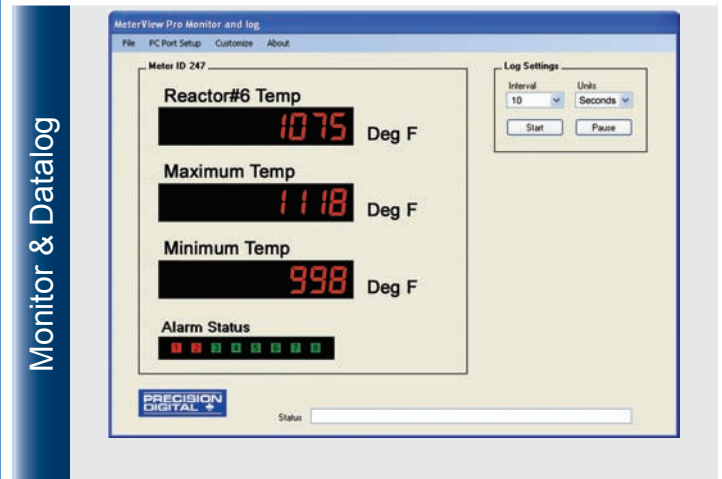

MULTIPLE SENSOR AVERAGING

The PD2-7000 can find the average temperature of up to 10 RTD probes connected in parallel. This new calculated value would then be treated as the PV (temperature) displayed on the meter. The average temperature is also available via Modbus communications and as the retransmitted value for the optional 4-20 mA output.

PD2-7000 Helios Dual-Line 6-Digit Temperature Meter

OUTPUTS

Relay Outputs

The Helios has up to four 3 A Form C relays (SPDT) with multiple power loss fail-safe options. Relays can be configured for proper protective action upon input loop break. Relay ON and OFF delay times are user adjustable. Up to four front panel indicators show alarm and/or relay state. All relays can be configured for 0-100% deadband.

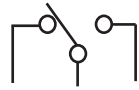

Relay Operation/Configuration

There are powerful relay functions that can be configured in the Helios meter, including:

- Automatic reset only (non-latching)
- Automatic + manual reset at any time (non-latching)
- Latching (manual reset only)
- Latching with clear (manual reset only after alarm condition has cleared)
- Pump alternation control (automatic reset only)
- Sampling (activated for a user-specified time)
- User selectable fail-safe operation
- Relay action for loss (break) of 4-20 mA input signal
- Time delay (on and off), independent for each relay
- Manual control mode
- Interlock relay mode

Analog Output

The isolated analog retransmission signal can be configured to represent the measured temperature (including average temperature), maximum or minimum temperature, any of the four relay set points, manual control setting, or Modbus input. While the output is nominally 4-20 mA, the signal will accurately accommodate under- and over-ranges from 1 to 23 mA. A power supply (24 V @ 40 mA) is standard with the 4-20 mA output option.

Manual Output Control

Take control of any output with this feature. All relays can be forced ON or OFF, and the 4-20 mA output signal can be set to any value within its range. When the relays and 4-20 mA output are controlled manually, an LED labeled "M" is turned on and the associated Alarm LEDs (1-4) flash every 10 seconds indicating that the meter is in manual control mode.



Interlock Relay(s)

This function allows a process to use one or more very low voltage input signals or simple switch contacts to control the state of one or more internal "interlock" relays. A violation (i.e. loss of input, open switch, or open circuit) forces one or more N/O interlock relay contacts to open. One input can be used in series with a number of interlock switches, or up to four inputs can be required to force-on one (or more) internal interlock relays. Please see *Safety Interlock on the ProVu® Series* whitepaper on our website for more information. Requires use of on-board digital I/O.

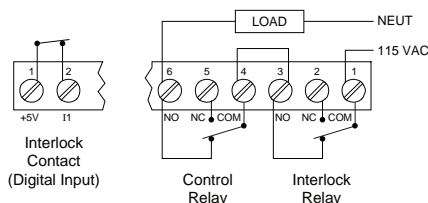

DIGITAL COMMUNICATIONS

Modbus® RTU Serial Communications

Helios meters can communicate with any Modbus Master device using the ever-popular Modbus communications protocol that is included in every Helios. This greatly increases the flexibility of the meter. Modbus provides much more capability than read PV and write set points.



Modbus PV Input



Remote Message

MOUNTING OPTIONS

Pipe Mounting Kit

The meter can also be mounted to a pipe using the optional pipe mounting kit (PDA6260). This kit includes two mounting plates, two U-bolts, and the necessary nuts and bolts. See *PD2-7000 manual for instructions*.

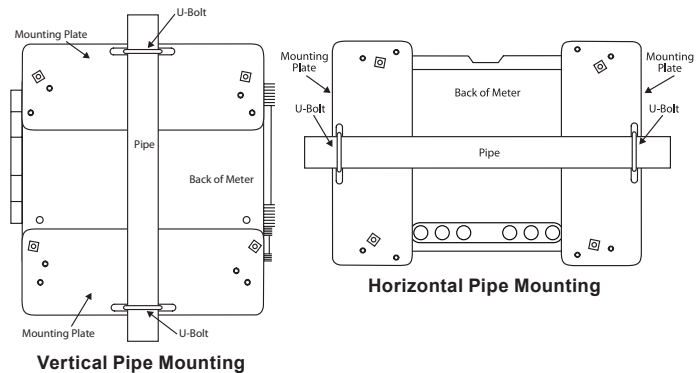

Wall Mounting

The meter can be mounted to any wall using the four provided mounting holes. Note that the bottom mounting holes are located behind the front door panel. See *manual for instructions*.

DIMENSIONS

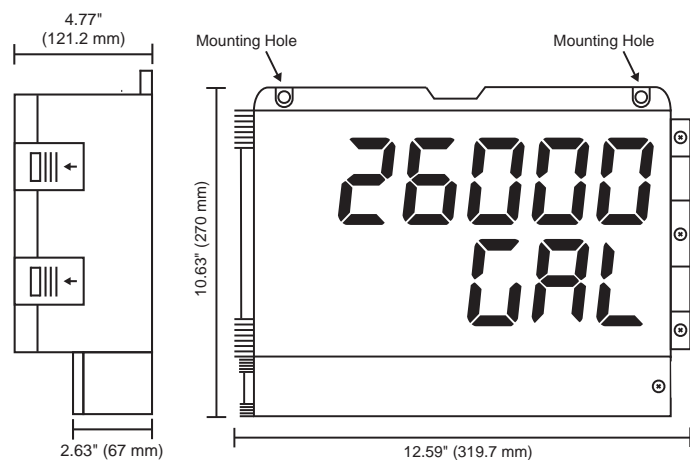

PD2-7000 Helios Dual-Line 6-Digit Temperature Meter

CONNECTIONS

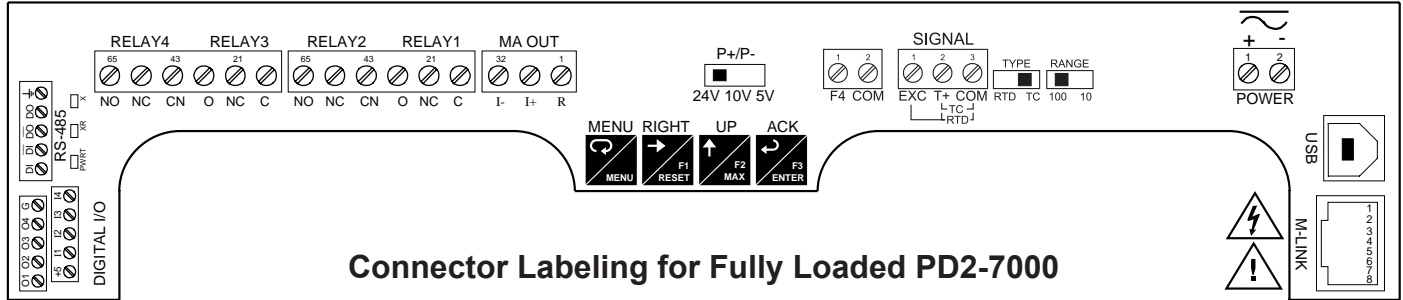

SPECIFICATIONS

Except where noted all specifications apply to operation at +25°C.

General

Display: Two lines with 1.8" (46 mm) high digits, red LEDs; 6 digits per line (-99999 to 999999), with lead zero blanking

Resolution: 1° or 0.1° for all thermocouples and RTD inputs

Display Intensity: Eight user selectable intensity levels

Display Update Rate: 5/second (200 ms)

Overrange: Display flashes 999999

Underrange: Display flashes -99999

Display Assignment: Line 1 and line 2 may be assigned to PV1, PV2, PCT, d r-u, d gross, d nt-g, max/min, max & min, set points, units (line 2 only), or Modbus input.

Programming Methods: Four programming buttons, digital inputs, PC and MeterView Pro software, or Modbus registers.

Noise filter: Programmable from 2 to 199 (0 will disable filter)

Filter Bypass: Programmable from 0.1 to 99.9% of calibrated span

Recalibration: All ranges are calibrated at the factory. Recalibration is recommended at least every 12 months.

Max/Min Display: Max/min readings reached by the process are stored until reset by the user or until power to the meter is turned off.

Password: Three programmable passwords restrict modification of programmed settings.

Pass 1: Allows use of function keys and digital inputs

Pass 2: Allows use of function keys, digital inputs and editing set/reset points

Pass 3: Restricts all programming, function keys, and digital inputs

Non-Volatile Memory: All programmed settings are stored in non-volatile memory for a minimum of ten years if power is lost.

Fuse: Required external fuse: UL Recognized, 5 A max, slow blow; up to 6 meters may share one 5 A fuse

Power Options: 85-265 VAC 50/60 Hz, 90-265 VDC, 20 W max or 12-24 VDC ± 10%, 15 W max. Powered over USB for configuration only.

Normal Mode Rejection: Greater than 65 dB at 50/60 Hz

Isolation: 4 kV input/output-to-power line
500 V input-to-output or output-to-P+ supply

Overvoltage Category: Installation Overvoltage Category II:
Local level with smaller transient overvoltages than Installation Overvoltage Category III.

Environmental:

Operating temperature range: -40 to 150°F (-40 to 65°C)

Storage temperature range: -40 to 185°F (-40 to 85°C)

Relative humidity: 0 to 90% non-condensing

Max Power Dissipation: PD8 Series: Maximum power dissipation limited to 15.1 W. See PD8 instruction manual for additional details.

Connections: Removable and integrated screw terminal blocks accept 12 to 22 AWG wire.

Enclosure: IP65 rated. Polycarbonate & glass blended plastic case, color: gray. Includes four PG11 through-hole conduit openings, with two factory installed PG11, IP68, black nylon threaded hole plugs with backing nuts.

Wall Mounting: Four (4) mounting holes provided for mounting meter to wall.

Pipe Mounting: Optional pipe mounting kit (PDA6260) allows for pipe mounting. Sold separately. See manual for mounting instructions.

Tightening Torque: *Removable Screw Terminals:* 5 lb-in (0.56 Nm)

Digital I/O and RS485 Terminals: 2.2 lb-in (0.25 Nm)

Overall Dimensions: 10.63" x 12.59" x 4.77"

(270 mm x 319.7 mm x 121.2 mm) (W x H x D)

Weight: 6.10 lbs (2.76 kg)

Warranty: 3 years parts & labor

USB Connection: Compatibility: USB 2.0 Standard, Compliant

Connector Type: Micro-B receptacle

Cable: USB A Male to Micro-B Cable

Driver: Windows 98/SE, ME, 2000, Server 2003/2008, XP 32/64-Bit, Vista 32/64-Bit, Windows 7 32/64-Bit, Windows 10 32/64-Bit

Power: USB Port

Temperature Input

Inputs: Thermocouple: J, K, T, E, R, S, B, N, C;

RTD: 100 Ω platinum (0.00385 & 0.00392 coefficients),

10 Ω copper, 120 Ω nickel, 1000 Ω platinum (0.00385 & 0.00392 coefficients)

Input Impedance: Greater than 100 kΩ

Offset Adjust: User programmable offset adjust ±50.0 degrees

Temperature Drift: ±2°C maximum from 0 to 65°C ambient temperature; ±4°C maximum from -20 to 0°C ambient temperature

Sensor Break Detection: Open TC or RTD sensor indicated by display flashing *aPEn*, relays can be programmed to go "On", "Off", or to "Ignore" (*Note: Ignore is detected as an upscale condition*).

Analogue output goes to the programmed sensor break value.

Averaging: Up to 10 RTDs connected in parallel can be averaged.

Accuracy & Range: See table below.

Type	Range (°F)	Range (°C)	Accuracy
J	-200 to 2000	-129 to 1093	±1°C
K	-200 to 2400	-129 to 1316	±1°C
T	-200 to 752	-129 to 400	±1°C
E	-200 to 1800	-129 to 982	±1°C
R	-50 to 3000	-46 to 1649	±2°C
S	-50 to 3000	-46 to 1649	±2°C
B	752 to 3300	400 to 1816	±2°C
N	-100 to 2300	-73 to 1260	±2°C
C	32 to 4100	0 to 2260	±2°C
10 Ω	-328 to 500	-200 to 260	±0.1°C
100 Ω	-328 to 1562	-200 to 850	±0.4°C
120 Ω	-110 to 500	-79 to 260	±0.1°C
1000 Ω	-328 to 900	-200 to 482	±0.4°C

PD2-7000 Helios Dual-Line 6-Digit Temperature Meter

Relays

Rating: 2 or 4 SPDT (Form C) internal and/or 4 SPST (Form A) external; rated 3 A @ 30 VDC and 125/250 VAC resistive load; 1/14 HP (≈ 50 W) @ 125/250 VAC for inductive loads

Noise Suppression: Noise suppression is recommended for each relay contact switching inductive loads.

Deadband: 0-100% of span, user programmable

High or Low Alarm: User may program any alarm for high or low trip point. Unused alarm LEDs and relays may be disabled (turned off).

Relay Operation: automatic (non-latching), latching (requires manual acknowledge), sampling (based on time), pump alternation control (2 to 8 relays), Off (disable unused relays and enable interlock feature, manual on/off control mode).

Time Delay: 0 to 999.9 seconds, on & off relay time delays.

Programmable and independent for each relay.

Fail-Safe Operation: Programmable and independent for each relay.

Note: Relay coil is energized in non-alarm condition. In case of power failure, relay will go to alarm state.

Auto Initialization: When power is applied to the meter, relays will reflect the state of the input to the meter.

Serial Communications

Protocol: Modbus[®] RTU

Meter Address/Slave ID: 1 - 247

Baud Rate: 300 - 19,200 bps

Transmit Time Delay: Programmable between 0 and 199 ms or transmitter always on for RS-422 communication

Data: 8 bit (1 start bit, 1 or 2 stop bits)

Parity: Even, odd, or none with 1 or 2 stop bits

Byte-to-Byte Timeout: 0.01 - 2.54 seconds

Turn Around Delay: Less than 2 ms (fixed)

Note: Refer to the PROVU[®] Modbus Register Tables located at www.predig.com for details.

Isolated 4-20 mA Transmitter Output

Output Source: Process variable (PV), max, min, set points 1-4, Modbus input, or manual control mode

Scaling Range: 1.000 to 23.000 mA for any display range

Calibration: Factory calibrated: 4.000 to 20.000 = 4-20 mA output

Analog Out Programming: 23.000 mA maximum for all parameters:

Overrange, underrange, max, min, and break

Accuracy: $\pm 0.1\%$ of span ± 0.004 mA

Temperature Drift: 0.4 $\mu\text{A}/^\circ\text{C}$ max from 0 to 65 $^\circ\text{C}$ ambient,

0.8 $\mu\text{A}/^\circ\text{C}$ max from -40 to 0 $^\circ\text{C}$ ambient

Note: Analog output drift is separate from input drift.

Isolated Transmitter Power Supply: Terminals I+ & R: 24 VDC $\pm 10\%$.

Isolated from the input at >500 V. May be used to power the 4-20 mA output or other devices. All models rated @ 40 mA max.

External Loop Power Supply: 35 VDC maximum

Output Loop Resistance:

Power Supply	Minimum	Maximum
24 VDC	10 Ω	700 Ω
35 VDC (external)	100 Ω	1200 Ω

ORDERING INFORMATION

PD2-7000 • Standard Models		
85-265 VAC Model	12-24 VDC Model	Options Installed
PD2-7000-6H0	PD2-7000-7H0	No Options
PD2-7000-6H7	PD2-7000-7H7	4 Relays & 4-20 mA Output

Note: 24 V Transmitter power supply standard on all models.

Accessories	
Model	Description
PDA6260	Pipe Mounting Kit
PDA7485-I	RS-232 to RS-422/485 Isolated Converter
PDA7485-N	RS-232 to RS-422/485 Non-Isolated Converter
PDA8485-I	USB to RS-422/485 Isolated Converter
PDA8485-N	USB to RS-422/485 Non-Isolated Converter
PDAPLUG2	Plastic Conduit Plug
PDX6901	Suppressor (snubber): 0.01 $\mu\text{F}/470 \Omega$, 250 VAC

Your Local Distributor is:

Disclaimer

The information contained in this document is subject to change without notice. Precision Digital Corporation makes no representations or warranties with respect to the contents hereof, and specifically disclaims any implied warranties of merchantability or fitness for a particular purpose. ©2016 Precision Digital Corporation. All rights reserved.

LDS2-7000_A 07/16