

# 1/16 - 1/8 - 1/4 DIN LIMIT CONTROLLERS CONCISE PRODUCT MANUAL (59333-2)

**CAUTION:** Installation should be only performed by technically competent personnel. Local Regulations regarding electrical installation & safety must be observed.

## 1. INSTALLATION

The models covered by this manual have three different DIN case sizes (refer to section 9). Some installation details vary between models. These differences have been clearly shown.

**Note:** The functions described in sections 2 thru 8 are common to all models.

### Installing Option Modules

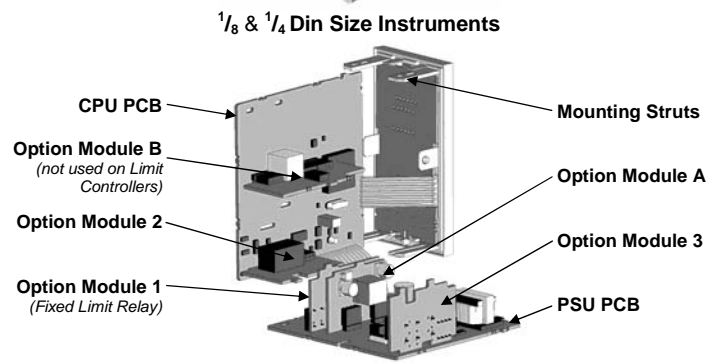
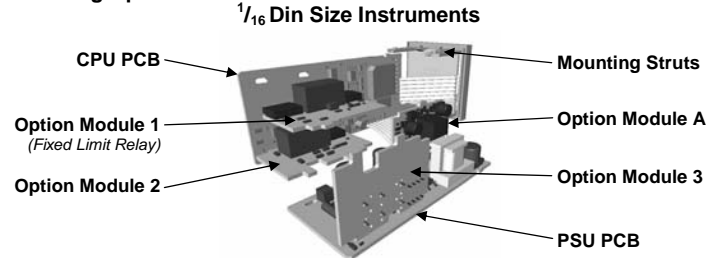

- To access module A, first detach the PSU and CPU boards from the front by lifting first the upper, and then lower mounting struts. Gently separate the boards.
- Plug the required option modules into the correct connectors, as shown below.
  - Locate the module tongues in the corresponding slot on the opposite board.
  - Hold the main boards together while relocating back on the mounting struts.
  - Replace the instrument by aligning the CPU and PSU boards with their guides in the housing, then slowly push the instrument back into position.

**Note:** Option modules are automatically detected at power up.

### Option Module Connectors

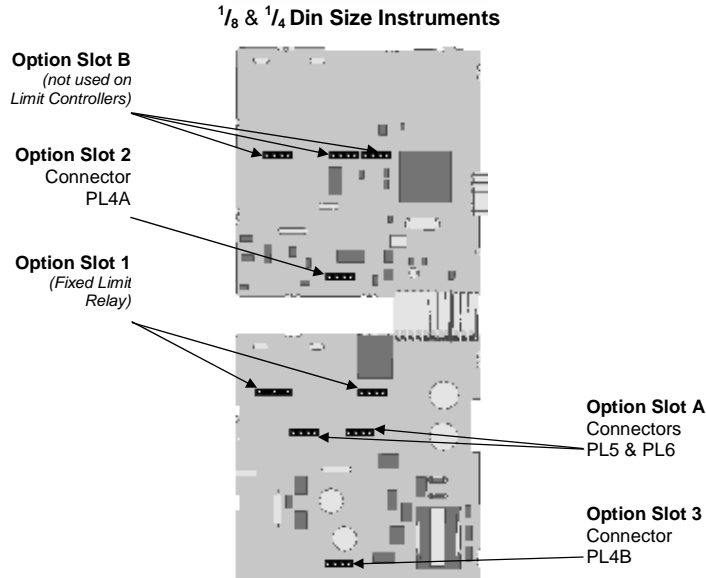
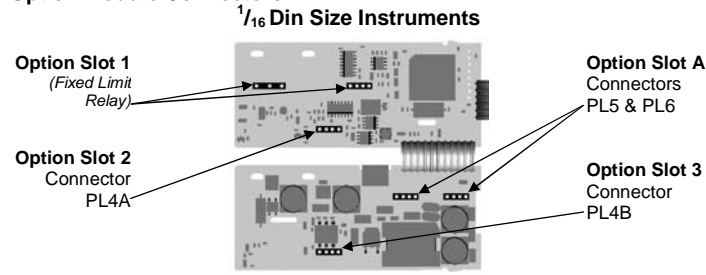

### Panel-Mounting

The mounting panel must be rigid, and may be up to 6.0mm (0.25inch) thick. Cut-out sizes are:

**Cut-Out Dim A**  
1/16 & 1/8 Din = 45mm  
1/4 Din = 92mm

**Cut-Out Dim B**  
1/16 Din = 45mm  
1/8 & 1/4 Din = 92mm

For *n* multiple instruments mounted side-by-side, cut-out A is 48*n*-4mm (1/16 & 1/8 Din) or 96*n*-4mm (1/4 Din)

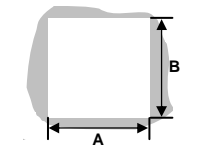

Tolerance +0.5, -0.0mm

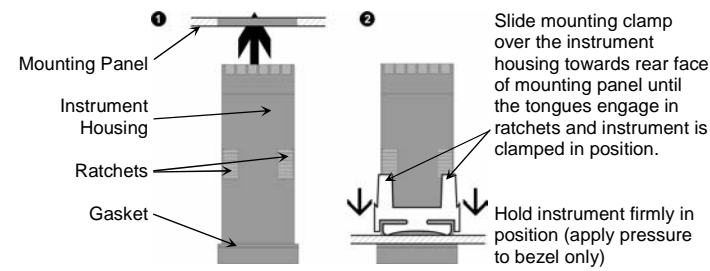

**CAUTION:** Do not remove the panel gasket; it is a seal against dust and moisture.

### Rear Terminal Wiring

USE COPPER CONDUCTORS (EXCEPT FOR T/C INPUT)

Single Strand wire gauge: Max 1.2mm (18SWG)

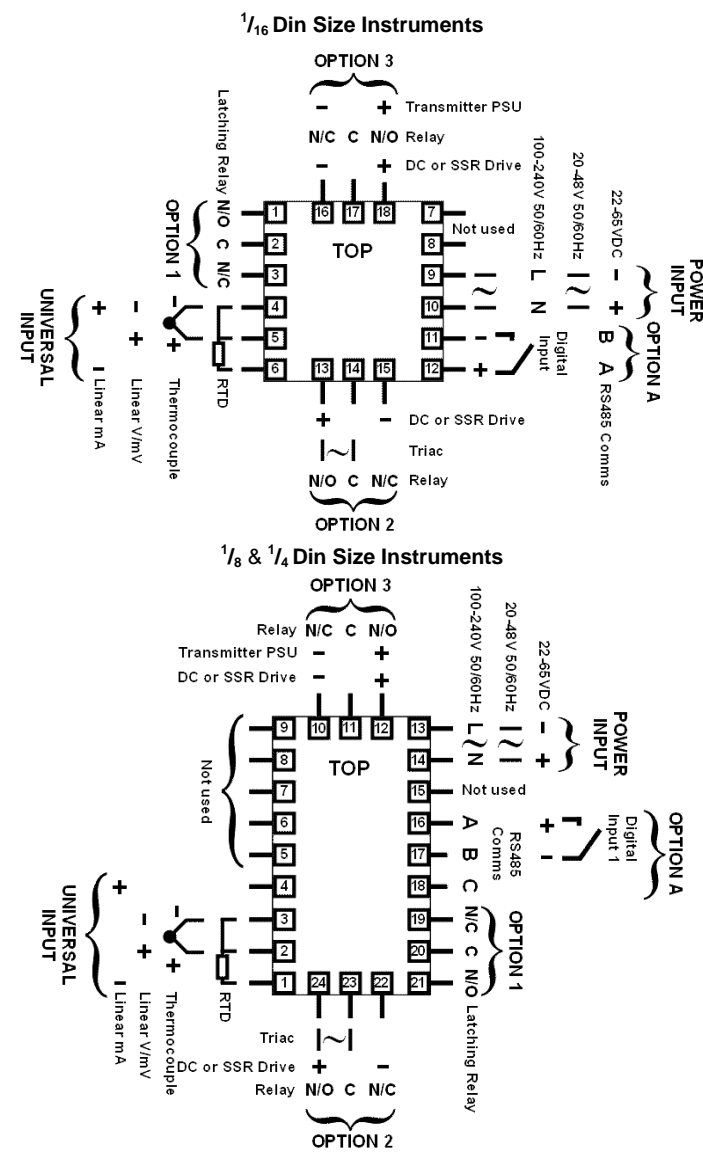

These diagrams show all possible option combinations. The actual connections required depends on the exact model and options fitted.

**CAUTION:** Check information label on housing for correct operating voltage before connecting supply to Power Input  
Fuse: 100 – 240V ac – 1amp anti-surge  
24/48V ac/dc – 315mA anti-surge

**Note:** At first power-up the message `UoLo Conf` is displayed, as described in section 6 of this manual. Access to other menus is denied until configuration mode is completed

## 2. SELECT MODE

Select mode is used to access the configuration and operation menu functions. It can be accessed at any time by holding down `⏏` and pressing `⏏`. In select mode, press `⏏` or `⏏` to choose the required mode, press `⏏` to enter. An unlock code is required to prevent unauthorised entry to Configuration, & Setup modes. Press `⏏` or `⏏` to enter the unlock code, then press `⏏` to proceed.

Mode	Upper Display	Lower Display	Description	Default Unlock Codes
Operator	OPtr	SLct	Normal operation	None
Set Up	SEtP	SLct	Tailor settings to the application	10
Configuration	CONF	SLct	Configure the instrument for use	20
Product Info	INFO	SLct	Check manufacturing information	None

**Note:** The instrument will always return automatically to Operator mode if there is no key activity for 2 minutes.

## 3. CONFIGURATION MODE

First select Configuration mode from Select mode (refer to section 2). Press `⏏` to scroll through the parameters, then press `⏏` or `⏏` to set the required value. Press `⏏` to accept the change, otherwise parameter will revert to previous value. To exit from Configuration mode, hold down `⏏` and press `⏏` to return to Select mode.

**Note:** Parameters displayed depends on how instrument has been configured. Refer to user guide (available from your supplier) for further details. Parameters marked \* are repeated in Setup Mode.

Parameter	Lower Display	Upper Display	Adjustment range & Description	Default Value	
Input Range/Type	inPt		See following table for possible codes	JC	
<b>Code</b>	<b>Input Type &amp; Range</b>	<b>Code</b>	<b>Input Type &amp; Range</b>	<b>Code</b>	<b>Input Type &amp; Range</b>
bC	B: 100 - 1824 °C	LC	L: 0.0 - 537.7 °C	P24F	PtRh20% vs 40%: 32 - 3362 °F
bF	B: 211 - 3315 °F	LF	L: 32.0 - 999.9 °F	PtC	Pt100: -199 - 800 °C
cC	C: 0 - 2320 °C	NC	N: 0 - 1399 °C	PtF	Pt100: -328 - 1472 °F
cF	C: 32 - 4208 °F	NF	N: 32 - 2551 °F	PtL	Pt100: -128.8 - 537.7 °C
JC	J: -200 - 1200 °C	rC	R: 0 - 1759 °C	PtF	Pt100: -199.9 - 999.9 °F
JF	J: -328 - 2192 °F	rF	R: 32 - 3198 °F	S	0 - 20 mA DC
JL	J: -128.8 - 537.7 °C	SC	S: 0 - 1762 °C	4.20	4 - 20 mA DC
JF	J: -199.9 - 999.9 °F	SF	S: 32 - 3204 °F	0.50	0 - 50 mV DC
K	K: -240 - 1373 °C	t	T: -240 - 400 °C	10.50	10 - 50 mV DC
KF	K: -400 - 2503 °F	tF	T: -400 - 752 °F	0.5	0 - 5 V DC
KL	K: -128.8 - 537.7 °C	tL	T: -128.8 - 400.0 °C	1.5	1 - 5 V DC
KF	K: -199.9 - 999.9 °F	tF	T: -199.9 - 752.0 °F	2.10	2 - 10 V DC
L	L: 0 - 762 °C	P24C	PtRh20% vs. 40%: 0 - 1850 °C		
LF	L: 32 - 1403 °F				

**Note:** Decimal point shown in table indicates temperature resolution of 0.1°

Parameter	Lower Display	Upper Display	Adjustment range & Description	Default Value
Scale Range Upper Limit	ruL		Scale Range Lower Limit +100 to Range Maximum	Range max (Lin=1000)
Scale Range Lower Limit	rLL		Range Minimum to Scale Range Upper Limit -100	Range min (Linear=0)
Decimal point position	dPos		0=XXXX, 1=XXX.X, 2=XX.XX, 3=X.XXX (non-temperature ranges only)	1
Process Variable Offset	OFFS		±Span of controller (see CAUTION note at end of section)	0
Limit Action	Ctrl		High Limit. Limit relay is energised when process "safe" (PV < Limit Setpoint) Low Limit. Limit relay is energised when process "safe" (PV > Limit Setpoint)	H
Setpoint Upper Limit	SPuL		Current Setpoint to Scale Range maximum	R/max
Setpoint Lower Limit	SPLL		Scale Range minimum to Current Setpoint	R/min
Alarm 1Type	ALA 1		P_H I Process High Alarm P_Lo Process Low Alarm dE Deviation Alarm bAnd Band Alarm nonE No alarm	P_H I
High Alarm 1 value*	PhA 1		Scaled Range Minimum to	Range Max
Low Alarm 1 value*	PLA 1		scaled Range Maximum in display units	Range Min
Band Alarm 1 value*	bAL 1		1 LSD to span from setpoint in display units	S
Dev. Alarm 1 value*	dAL 1		+/- Span from setpoint in display units	S
Alarm 1 Hysteresis*	AHY 1		1 LSD to full span in display units	I







Parameter	Lower Display	Upper Display	Adjustment range & Description	Default Value
Alarm 2 Type*	ALA2			P_Lo
High Alarm 2 value*	PhA2		Range Max	
Low Alarm 2 value*	PLA2		Range Min	
Band Alarm 2 value*	bAL2		Options as for alarm 1	S
Dev. Alarm 2 Value*	dAL2			S
Alarm 2 Hysteresis*	AHY2			I
Output 2 Usage	USE2	Lrnt	Limit Output Relay	
		A1_d	Alarm 1, Direct	A1_d
		A1_r	Alarm 1, Reverse	
		A2_d	Alarm 2, Direct	
		A2_r	Alarm 2, Reverse	
		Or_d	Logical Alarm 1 OR 2, Direct	
		Or_r	Logical Alarm 1 OR 2, Reverse	
		Ad_d	Logical Alarm 1 AND 2, Direct	
		Ad_r	Logical Alarm 1 AND 2, Reverse	
		An_d	Limit Annunciator, Direct	
An_r	Limit Annunciator, Reverse			
rEtS	Retransmit Limit SP Output			
rEtP	Retransmit PV Output	rEtP		
Linear Output 2 Range	LYP2	0.5	0 to 5 V DC output 1	
		0_10	0 to 10 V DC output	0_10
		2_10	2 to 10 V DC output	
		0_20	0 to 20 mA DC output	
Retransmit Output 2 Scale maximum	ro2H	-1999 to 9999	(display value at which output will be maximum)	Range max
		-1999 to 9999	(display value at which output will be minimum)	Range min
		As for output 2		
		As for output 2		
Retransmit Output 3 Scale maximum	ro3H	-1999 to 9999	(display value at which output will be maximum)	Range max
		-1999 to 9999	(display value at which output will be minimum)	Range min
		As for output 2		
		As for output 2		
Display Strategy	dSP	ErAb	PV is visible in Operator mode	ErAb
		dSA	PV not visible in Operator mode	
		SAFE	Displays SAFE in Operator mode when Limit Output is not active	
Serial Communications Protocol	Prot	ASC 1	ASCII	
		r7bn	Modbus with no parity	r7bn
		r7be	Modbus with Even Parity	
Serial Communications Bit Rate	bAud	1.2	1.2 kbps	
		2.4	2.4 kbps	4.8
		4.8	4.8 kbps	
		9.6	9.6 kbps	
Comms Address	Addr	1 to 255 (Modbus), 1 to 99 (ASCII)		I
		Read/Write		
Comms Write	CoEn	r_0	Read only	r_0
Configuration Lock Code	Loc		0 to 9999	20

**Notes:** Output 1 is always a Latching Limit Relay output. If Option Slot A has the Digital Input module fitted, this always functions as a Remote Reset, duplicating the function of the Reset key.

As these functions cannot be changed, no Configuration menus are required.

**CAUTION:** Process Variable Offset can be used to modify the measured value to compensate for probe errors. Positive values increase the reading, negative values are subtracted. This parameter is effectively, a calibration adjustment and MUST be used with care. There is no front panel indication of when this parameter is in use.

## 4. SETUP MODE



**Note: Configuration must be completed before adjusting Setup parameters.** First select Setup mode from Select mode (refer to section 2). The Setup LED  will light while in Setup mode. Press  to scroll through the parameters, then press  or  to set the required value. To exit from Setup mode, hold down  and press  to return to Select mode. **Note: Parameters displayed depends on how instrument has been configured.**

Parameter	Lower Display	Upper Display Adjustment Range & Description	Default Value
Limit Setpoint value	SP	Scaled Range Minimum to scaled Range Maximum	R/max if $Ctrl=Hi$ R/min if $Ctrl=Lo$
Limit Hysteresis	HYS	1 LSD to full span in display units, on the safe side of the limit SP	1
Input Filter Time Constant	FIL	OFF or 0.5 to 100.0 secs (see CAUTION note below)	2.0
High Alarm 1 value	PhA1	Scaled Range Minimum to scaled Range Maximum	R/max
Low Alarm 1 value	PLA1	Scaled Range Maximum	R/min
Deviation Alarm 1 Value	dAL1	±Span from SP in display units	5
Band Alarm 1 value	bAL1	1 LSD to span from setpoint	5
Alarm 1 Hysteresis	AHY1	1 LSD to full span in display units	1
High Alarm 2 value	PhA2	Scaled Range Minimum to scaled Range Maximum	R/max
Low Alarm 2 value	PLA2	Scaled Range Maximum	R/min
Deviation Alarm 2 Value	dAL2	±Span from SP in display units	5
Band Alarm 2 value	bAL2	1 LSD to span from setpoint	5
Alarm 2 Hysteresis	AHY2	1 LSD to full span in display units	1
Setup Lock Code	SLoc	0 to 9999	10

**Note: Operator mode screens follow, without exiting from Setup mode.**





 **CAUTION: An excessively large filter time could significantly delay detection of a limit condition. Set this value to the minimum required to remove noise from the process variable**

## 5. PRODUCT INFORMATION MODE

First select Product information mode from Select mode (refer to section 2). Press  to view each parameter. To exit from Product Information mode, hold down  and press  to return to Select mode. **Note: These parameters are all read only.**



Parameter	Lower Display	Upper Display	Description
Input type	In_1	Un_1	Universal input
Option 1 type (fixed)	OPn1	rLY	Latching Limit Relay
Option 2 module type fitted	OPn2	nonE	No option fitted
		rLY	Relay output
		SSr	SSR drive output
		tr_1	Triac output
Option 3 module type fitted	OPn3	L in	Linear DC voltage / current output
		nonE	No option fitted
		rLY	Relay output
		SSr	SSR drive output
Auxiliary Option A module type fitted	OPnA	L in	Linear DC voltage / current output
		dc24	Transmitter power supply
		nonE	No option fitted
Firmware type	FLW	r485	RS485 communications
		dIG_1	Digital Input for remote reset
Firmware issue	ISS		Value displayed is firmware issue number
Product Revision Level	PrL		Value displayed is Product Revision level
Date of manufacture	dDYY		Manufacturing date code (mmyy)
Serial number 1	Sn1		First four digits of serial number
Serial number 2	Sn2		Middle four digits of serial number
Serial number 3	Sn3		Last four digits of serial number

## 6. ERROR/FAULT INDICATIONS

Parameter	Upper Display	Lower Display	Description
Instrument parameters are in default conditions	CoFo	ConF	Configuration & Setup required. This screen is seen at first turn on, or if hardware configuration has been changed. Press  to enter the Configuration Mode, next press  or  to enter the unlock code number, then press  to proceed
Input Over Range	CHH	Normal	Process variable input > 5% over-range as above if Display Strategy = SAFE
Input Under Range	LLL	Normal	Process variable input > 5% under-range as above if Display Strategy = SAFE
Input Sensor Break	OPEN	Normal	Break detected in process variable input sensor or wiring as above if Display Strategy = SAFE
Option 1 Error	Err	OPn1	Option 1 module fault
Option 2 Error		OPn2	Option 2 module fault
Option 3 Error		OPn3	Option 3 module fault
Option A Error		OPnA	Option A module fault
Option B Error		OPnb	Option B not used on Limit Controllers this error is shown if any module is fitted

## 7. OPERATOR MODE



This mode is entered at power on, or accessed from Select mode (see section 2). **Note: All Configuration mode and Setup mode parameters must be set as required before starting normal operations.** Press  to scroll through the parameters.

Upper Display	Lower Display	Display Strategy and When Visible	Description
PV Value	Limit SP Value	d SP = EnAb (initial screen)	PV and Limit Setpoint values Read only
Limit SP Value	(Blank)	d SP = d SA (initial screen)	Limit Setpoint value Read only
SAFE or rSEt	(Blank) or PV Value	d SP = SAFE (Initial Screen)	Displays rSEt and PV if Limit Output is active or SAFE and blank if not active. Read only
High Limit Hold	H Hd	Ctrl = Hi	Highest PV value since this parameter was last reset. To reset, press  for 5 seconds, display = ---- when reset
Low Limit Hold	LoHd	Ctrl = Lo	Lowest PV value since this parameter was last reset. To reset, press  for 5 seconds, display = ---- when reset
Exceed Time Value	t_1	Always available Format mm.ss to 99.99 then mmm.s (10 sec increments) Shows CHH if ≥999.9	Accumulated time of Limit SP exceed conditions since this parameter was last reset. To reset, press  for 5 seconds, display = ---- when reset
Active Alarm Status	ALSt	When one or more alarms are active. ALM indicator will also flash	Alarm 2 active Alarm 1 active Annunciator active

### Exceed Condition

An Exceed Condition is when the Process Variable exceeds the Limit Setpoint value (i.e. PV > SP when set for high limit action, PV < SP for low limit action). The LED is on during this condition, and is extinguished once it has passed.

### Limit Output Function

Limit Output relay(s) de-energise whenever an Exceed condition occurs, causing the process to shut down. The  LED is on when the relay is de-energised. The relay remains latched off even if the Exceed condition is no longer present. Only giving a reset instruction (after the exceed condition has passed) will re-energise the relay, allowing the process to continue. The  LED then turns off.

### Limit Annunciator Outputs

An Annunciator output will activate when an Exceed condition occurs, and will remain active until a reset instruction is received, or the Exceed condition has passed. Unlike the Limit Output, an Annunciator can be reset even if the Exceed condition is present. When an Annunciator is active, the  LED will flash and the Alarm Status screen is available.

### Resetting Limit Outputs & Annunciators

A reset instruction can be given by pressing the  key, via the Digital Input (if fitted) or via a Comms command if an RS485 Communications module is fitted. Annunciators will deactivate. Limit Outputs will only re-energise if the Exceed condition has passed.

 **CAUTION: Ensure that the cause of the Exceed condition has been rectified before resetting the Limit Output.**

## 8. SERIAL COMMUNICATIONS

Refer to the full user guide (available from your supplier) for details.

## 9. SPECIFICATIONS

### UNIVERSAL INPUT

Thermocouple: ±0.1% of full range, ±1LSD (±1°C for Thermocouple CJC).  
Calibration: BS4937, NBS125 & IEC584.  
PT100 Calibration: ±0.1% of full range, ±1LSD.  
BS1904 & DIN43760 (0.00385Ω/Ω°C).

DC Calibration: ±0.1% of full range, ±1LSD.

Sampling Rate: 4 per second.

Impedance: >10MΩ resistive, except DC mA (5Ω) and V (47kΩ).

Sensor Break Detection: Thermocouple, RTD, 4 to 20 mA, 2 to 10V and 1 to 5V ranges only. Limit outputs turn off (goes into Exceed condition), high alarms activate for thermocouple/RTD sensor break, low alarms activate for mA/V DC sensor break.

Isolation: Isolated from all outputs (except SSR driver).

Universal input must not be connected to operator accessible circuits if relay outputs are connected to a hazardous voltage source. Supplementary insulation or input grounding would then be required.

### DIGITAL INPUT

Volt-free(or TTL): Open(2 to 24VDC) =No Reset.  
Closed(<0.8VDC) = Reset (edge triggered).

Isolation: Reinforced safety isolation from inputs and other outputs.

### OUTPUTS

#### Limit Relay

Contact Type & Rating: Latching limit control relay. Single pole double throw (SPDT); 5A resistive at 120/240VAC. Slot 1 position fixed for this function, optional function for Slot 2 & 3 relay modules.

Lifetime: >100,000 operations at rated voltage/current.

Isolation: Basic Isolation from universal input and SSR outputs.

#### Alarm Relays

Contact Type & Rating: Slot 2 or 3 position non-latching alarm relay. Single pole double throw (SPDT); 2A resistive at 120/240VAC.

Lifetime: >500,000 operations at rated voltage/current.

Isolation: Basic Isolation from universal input and SSR outputs.

#### SSR Driver

Drive Capability: SSR drive voltage >10V into 500Ω min.

Isolation: Not isolated from universal input or other SSR driver outputs.

#### Triac

Operating Voltage: 20 to 280Vrms (47 to 63Hz).

Current Rating: 0.01 to 1A (full cycle rms on-state @ 25°C); derates linearly above 40°C to 0.5A @ 80°C.

Isolation: Reinforced safety isolation from inputs and other outputs.

#### DC

Resolution: 8 bits in 250mS (10 bits in 1s typical, >10 bits in >1s typical).

Isolation: Reinforced safety isolation from inputs and other outputs.

#### Transmitter PSU

Power Rating: 20 to 28V DC (24V nominal) into 910Ω minimum resistance.

Isolation: Reinforced safety isolation from inputs and other outputs.

### SERIAL COMMUNICATIONS

Physical: RS485, at 1200, 2400, 4800, 9600 or 19200 bps.

Protocols: Selectable between Modbus and West ASCII.

Isolation: Reinforced safety isolation from all inputs and outputs.

### OPERATING CONDITIONS (FOR INDOOR USE)

Ambient: 0°C to 55°C (Operating), -20°C to 80°C (Storage).

Temperature:

Relative Humidity: 20% to 95% non-condensing.

Supply Voltage and Power: 100 to 240VAC ±10%, 50/60Hz, 7.5VA

(for mains powered versions), or 20 to 48VAC 50/60Hz 7.5VA or 22 to 65VDC 5W (for low voltage versions).

### ENVIRONMENTAL

Standards: CE, UL, ULC & FM 3545, 1998

EMI: Complies with EN61326 (Susceptibility & Emissions).

Safety: Complies with EN61010-1 & UL3121.

Considerations: Pollution Degree 2, Installation Category II.

Front Panel Sealing: To IP66 (IP20 behind the panel).

### PHYSICAL

Front Bezel Size:  $\frac{1}{16}$  Din = 48 x 48mm,  $\frac{1}{8}$  Din = 96 x 48mm,  $\frac{1}{4}$  Din = 96 x 96mm.

Depth Behind Panel:  $\frac{1}{16}$  Din = 110mm,  $\frac{1}{8}$  &  $\frac{1}{4}$  Din = 100mm.

Weight: 0.21kg maximum.