

UDC2300 Universal Digital Indicator Product Manual

Doc. No.: 51-52-25-84
Release: A
Last Revision Date: 10/00

Copyright, Notices, and Trademarks

Printed in U.S.A. – © Copyright 2000 by Honeywell

Revision A – October 2000

WARRANTY/REMEDY

Honeywell warrants goods of its manufacture as being free of defective materials and faulty workmanship. Contact your local sales office for warranty information. If warranted goods are returned to Honeywell during the period of coverage, Honeywell will repair or replace without charge those items it finds defective. The foregoing is Buyer's sole remedy and is **in lieu of all other warranties, expressed or implied, including those of merchantability and fitness for a particular purpose**. Specifications may change without notice. The information we supply is believed to be accurate and reliable as of this printing. However, we assume no responsibility for its use.

While we provide application assistance personally, through our literature and the Honeywell web site, it is up to the customer to determine the suitability of the product in the application.

Sensing and Control
Honeywell
11 West Spring Street
Freeport, Illinois 61032

UDC2300 is a trademark of Honeywell

About This Document

Abstract

This document provides descriptions and procedures for the installation, configuration, operation, and troubleshooting of your UDC2300 Indicator.

Contacts

World Wide Web

The following lists Honeywell's World Wide Web sites that will be of interest to our customers.

Honeywell Organization	WWW Address (URL)
Corporate	http://www.honeywell.com
Sensing and Control	http://www.honeywell.com/sensing
International	http://www.honeywell.com/Business/global.asp













Telephone

Contact us by telephone at the numbers listed below.

	Organization	Phone Number
United States and Canada	Honeywell	1-800-423-9883 Tech. Support 1-888-423-9883 Q&A Faxback (TACFACS) 1-800-525-7439 Service
Asia Pacific	Honeywell Asia Pacific Hong Kong	(852) 2829-8298
Europe	Honeywell PACE, Brussels, Belgium	[32-2] 728-2111
Latin America	Honeywell, Sunrise, Florida U.S.A.	(854) 845-2600

Symbol Definitions

The following table lists those symbols that may be used in this document to denote certain conditions.

Symbol	Definition
	This DANGER symbol indicates an imminently hazardous situation, which, if not avoided, will result in death or serious injury .
	This WARNING symbol indicates a potentially hazardous situation, which, if not avoided, could result in death or serious injury .
	This CAUTION symbol may be present on Control Product instrumentation and literature. If present on a product, the user must consult the appropriate part of the accompanying product literature for more information.
	This CAUTION symbol indicates a potentially hazardous situation, which, if not avoided, may result in property damage .
	WARNING PERSONAL INJURY: Risk of electrical shock. This symbol warns the user of a potential shock hazard where HAZARDOUS LIVE voltages greater than 30 Vrms, 42.4 Vpeak, or 60 Vdc may be accessible. Failure to comply with these instructions could result in death or serious injury.
	ATTENTION, Electrostatic Discharge (ESD) hazards. Observe precautions for handling electrostatic sensitive devices
	Protective Earth (PE) terminal. Provided for connection of the protective earth (green or green/yellow) supply system conductor.
	Functional earth terminal. Used for non-safety purposes such as noise immunity improvement. NOTE: This connection shall be bonded to protective earth at the source of supply in accordance with national local electrical code requirements.
	Earth Ground. Functional earth connection. NOTE: This connection shall be bonded to Protective earth at the source of supply in accordance with national and local electrical code requirements.
	Chassis Ground. Identifies a connection to the chassis or frame of the equipment shall be bonded to Protective Earth at the source of supply in accordance with national and local electrical code requirements.
	Earth Ground. Functional earth connection. NOTE: This connection shall be bonded to Protective earth at the source of supply in accordance with national and local electrical code requirements.
	Chassis Ground. Identifies a connection to the chassis or frame of the equipment shall be bonded to Protective Earth at the source of supply in accordance with national and local electrical code requirements.

Contents

1	INTRODUCTION	1
1.1	Overview	1
1.2	CE Conformity (Europe).....	2
2	INSTALLATION	3
2.1	Overview	3
2.2	Model Number Interpretation	5
2.3	Preliminary Checks	6
2.4	Alarm Relay Contact Information.....	8
2.5	Mounting.....	9
2.6	Wiring	11
2.7	Wiring Diagrams.....	12
3	INITIAL START-UP	17
3.1	Overview	17
3.2	Powering Up the Indicator	17
3.3	Operator Interface and Key Functions	18
3.4	Key Error Message.....	18
4	CONFIGURATION	19
4.1	Overview	19
4.2	Configuration Prompt Hierarchy	20
4.3	Configuration Procedure.....	21
4.4	Lock Set Up Group	22
4.5	Input Set Up Group.....	23
4.6	Communications Set Up Group	27
4.7	Alarms Set Up Group.....	30
4.8	Configuration Record Sheet.....	32
5	MONITORING THE INDICATOR	33
5.1	Overview	33
5.2	Operator Interface	34
5.3	Entering a Security Code	34
5.4	Lockout Feature	35
5.5	Monitoring Your Indicator.....	36
5.6	Alarm Setpoints.....	37

6	INPUT CALIBRATION	39
6.1	Overview	39
6.2	Minimum and Maximum Range Values	40
6.3	Preliminary Information.....	41
6.4	Input Set Up Wiring	43
6.5	Input Calibration Procedure	45
6.6	Restore Factory Calibration	47
7	TROUBLESHOOTING/SERVICE	49
7.1	Overview	49
7.2	Troubleshooting Aids.....	51
7.3	Power-up Tests.....	53
7.4	Status Tests	53
7.5	Background Tests.....	54
7.6	Indicator Failure Symptoms	55
7.7	Troubleshooting Procedures	56
8	PARTS LIST.....	59
8.1	Exploded View.....	59
9	INDEX	61

Tables

Table 2-1 Condensed Specifications _____	4
Table 2-2 Preliminary Checks _____	6
Table 2-3 Alarm Relay Contact Information _____	8
Table 2-4 Mounting Procedure _____	10
Table 2-5 Permissible Wiring Bundling _____	12
Table 4-1 Configuration Prompt Hierarchy _____	20
Table 4-2 Configuration Procedure _____	21
Table 4-3 LOCK Group (Numeric Code 200) Function Prompts _____	22
Table 4-4 INPUT Group (Numeric Code 600) Function Prompts _____	23
Table 4-5 Communications Group (Numeric Code 1000) Function Prompts _____	27
Table 4-6 ALARMS Group (Numeric Code 1100) Function Prompts _____	30
Table 5-1 Procedure to Enter a Security Code _____	35
Table 5-2 Annunciators _____	36
Table 5-3 Error Messages _____	36
Table 5-4 Procedure for Displaying Alarm Setpoints _____	37
Table 6-1 Voltage and Resistance Equivalents for Input Range Values _____	40
Table 6-2 Equipment Needed _____	42
Table 6-3 Set Up Wiring Procedure for Thermocouple Inputs Using an Ice Bath _____	43
Table 6-4 Set Up Wiring Procedure for Thermocouple Inputs using Thermocouple Source _____	43
Table 6-5 Set Up Wiring Procedure for RTD Inputs _____	44
Table 6-6 Set Up Wiring Procedure for Radiamatic, Milliampere, Millivolts, or Volts Inputs (Except 0-10 Volts) _____	44
Table 6-7 Set Up Wiring Procedure for 0 to 10 Volts _____	45
Table 6-8 Input Calibration Procedure _____	46
Table 6-9 Restore Factory Calibration _____	48
Table 7-1 Procedure for Identifying the Software Version _____	52
Table 7-2 Procedure for Displaying the Status Test Results _____	53
Table 7-3 Background Tests _____	54
Table 7-4 Indicator Failure Symptoms _____	55
Table 7-5 Troubleshooting Power Failure Symptoms _____	57
Table 7-6 Troubleshooting Alarm Relay Output Failure _____	57
Table 7-7 Troubleshooting a Keyboard Failure _____	58
Table 8-1 Parts Identification _____	59
Table 8-2 Parts Not Shown _____	60

Figures

Figure 1-1 UDC2300 Indicator Operator Interface	1
Figure 2-1 Indicator Model Number Interpretation	5
Figure 2-2 Jumper Placements	7
Figure 2-3 Mounting Dimensions (not to scale)	9
Figure 2-4 Mounting Method	10
Figure 2-5 Composite Wiring Diagram	12
Figure 2-6 Mains Power Supply	13
Figure 2-7 Input Connections	13
Figure 2-8 Alarm Relay Output Connections	14
Figure 2-9 Open Collector Alarm Relay Output	14
Figure 2-10 External Interface Option Connections	15
Figure 3-1 Operator Interface and Key Functions	18
Figure 5-1 Operator Interface	34
Figure 6-1 Input Wiring Terminals	41
Figure 6-2 Wiring Connections for Thermocouple Inputs Using an Ice Bath	43
Figure 6-3 Wiring Connections for Thermocouple Inputs Using Thermocouple Source	43
Figure 6-4 Wiring Connections for RTD (Resistance Thermometer Device)	44
Figure 6-5 Wiring Connections for Radiamatic, Milliampere, Millivolts, or Volts (Except 0 to 10 Volts)	45
Figure 6-6 Wiring Connections for 0 to 10 Volts	45
Figure 8-1 UDC2300 Exploded View	59

1 Introduction

1.1 Overview

The UDC2300 Indicator model provides only indication and alarms of Analog Inputs. No control functionality is included.

The UDC2300 Indicator monitors temperatures and other variables in applications such as environmental chambers, plastic processing machines, furnaces and ovens, and packaging machinery.

The Input type and range are completely field selectable. The indicator has a dedicated configuration display which provides prompts in various languages providing unmatched operating simplicity. Programmed sequence of displays assure quick and accurate entry of the configurable parameters. Simple keystrokes let you change alarm setpoints to meet your process needs.

The UDC2300 Indicator model is also downward compatible with existing UDC2000 Indicator model applications and installations **except** for RTD and 0-10 Volt inputs and Open Collector outputs.

See wiring diagrams in Section 2 - Installation.

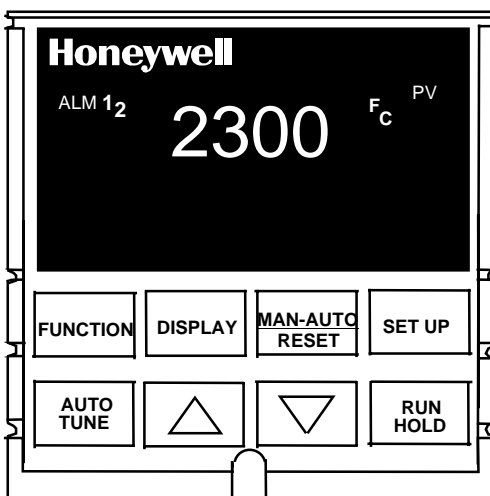

Figure 1-1 UDC2300 Indicator Operator Interface

1.2 CE Conformity (Europe)

This product is in conformity with the protection requirements of the following European Council Directives: **73/23/EEC**, the Low Voltage Directive, and **89/336/EEC**, the EMC Directive. Conformity of this product with any other “CE Mark” Directive(s) shall not be assumed.

Product Classification: Class I: Permanently connected, panel-mounted Industrial Control Equipment with protective earthing (grounding). (EN61010-1).

Enclosure Rating: Panel-mounted equipment, IP 00. This indicator must be panel-mounted. Terminals must be enclosed within the panel. Front panel IP 65 (IEC 529).

Installation Category (Overvoltage Category): Category II: Energy-consuming equipment supplied from the fixed installation, local level appliances, and Industrial Control Equipment. (EN61010-1)

Pollution Degree: Pollution Degree 2: Normally non-conductive pollution with occasional conductivity caused by condensation. (Ref. IEC 664-1)

EMC Classification: Group 1, Class A, ISM Equipment (EN55011, emissions), Industrial Equipment (EN50082-2, immunity)

Method of EMC Assessment: Technical File (TF)

Declaration of Conformity: 51309602-000

Deviation from the installation conditions specified in this manual, and the special conditions for CE conformity in Section 2.1, may invalidate this product’s conformity with the Low Voltage and EMC Directives.

2 Installation

2.1 Overview

Introduction

Installation of the UDC2300 consists of mounting and wiring the indicator according to the instructions given in this section. Read the pre-installation information, check the model number interpretation (Subsection 2.2), and become familiar with your model selections, then proceed with installation.

What's in this section?

The following topics are covered in this section.

TOPIC	See Page
2.1 Overview	3
2.2 Model Number Interpretation	5
2.3 Preliminary Checks	6
2.4 Alarm Relay Contact Information	8
2.5 Mounting	9
2.6 Wiring	11
2.7 Wiring Diagrams	12

Pre-installation Information

If the indicator has not been removed from its shipping carton, inspect the carton for damage then remove the indicator.

- Inspect the unit for any obvious shipping damage and report any damage due to transit to the carrier.
- Make sure a bag containing mounting hardware is included in the carton with the indicator.
- Check that the model number shown on the inside of the case agrees with what you have ordered.

Condensed Specifications

Honeywell recommends that you review and adhere to the operating limits listed in Table 2-1 when you install your indicator.

Table 2-1 Condensed Specifications

<p>Operating Limits</p>	<p>Ambient Temperature: 32 °F to 131 °F (0 °C to 55 °C) Relative Humidity: 5 % to 90 % RH up to 104 °F (40 °C) Vibration: <i>Frequency:</i> 0 Hz to 200 Hz <i>Acceleration:</i> 0.6 g Mechanical Shock: <i>Acceleration:</i> 5 g <i>Duration:</i> 30 ms Power: 90 Vac to 264 Vac, 50/60 Hz (CSA models rated to 250 Vac maximum) Power Consumption: 12 VA maximum</p>
<p>Accuracy</p>	<p>± 0.25 % of span typical ± 1 digit for display 15-bit resolution typical</p>
<p>CE Conformity Special Conditions (Europe)</p>	<p>Shielded twisted-pair cables are required for all analog I/O, process variable, RTD, thermocouple, dc millivolt, low level signal, 4-20 mA, digital I/O, and computer interface circuits. <i>Refer to 51-52-05-01, How to Apply Digital Instrumentation in Severe Electrical Noise Environments, for additional information.</i></p>

2.2 Model Number Interpretation

Introduction

Write the model number into the spaces provided in

Figure 2-1 and compare it to the model number interpretation. This information will also be useful when you wire your indicator.

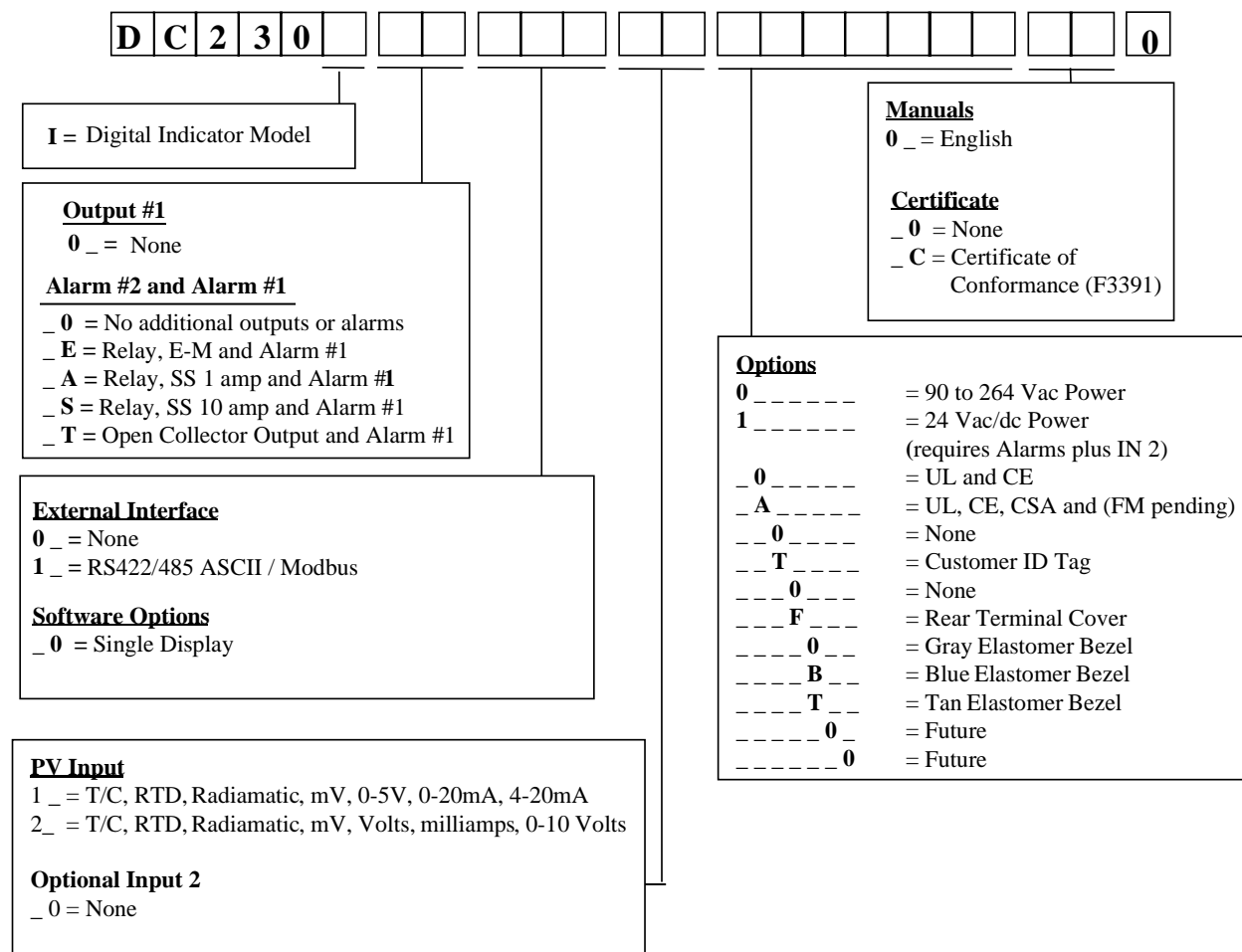

Figure 2-1 Indicator Model Number Interpretation

2.3 Preliminary Checks

Introduction

Before you install the indicator, remove the chassis and make any preliminary checks necessary that are listed in Table 2-2. Figure 2-2 shows the locations for jumper placements.

Table 2-2 Preliminary Checks

Check Number	Preliminary Check	Description
1	Input I Jumper Placement	Check the internal jumper for INPUT 1 to make sure it is set for the correct input type. The jumper is located at position S101 on the printed wiring board. Figure 2-2 shows the location of the jumper and position selections.
4	Alarm Relay Action.	<p>The indicator has been shipped with ALARM relays configured for N.C. (Normally Closed). If you want to change to N.O. refer to Figure 2-2, Jumper positions W201 and W202:</p> <p>W201 is the ALARM RELAY 1 jumper.</p> <p>W202 is the jumper ALARM RELAY 2.</p> <p>See Table 2-3 for Alarm Relay contact information.</p> <p>See Alarm Relay Caution Note, Page 8.</p>

Jumper Placements

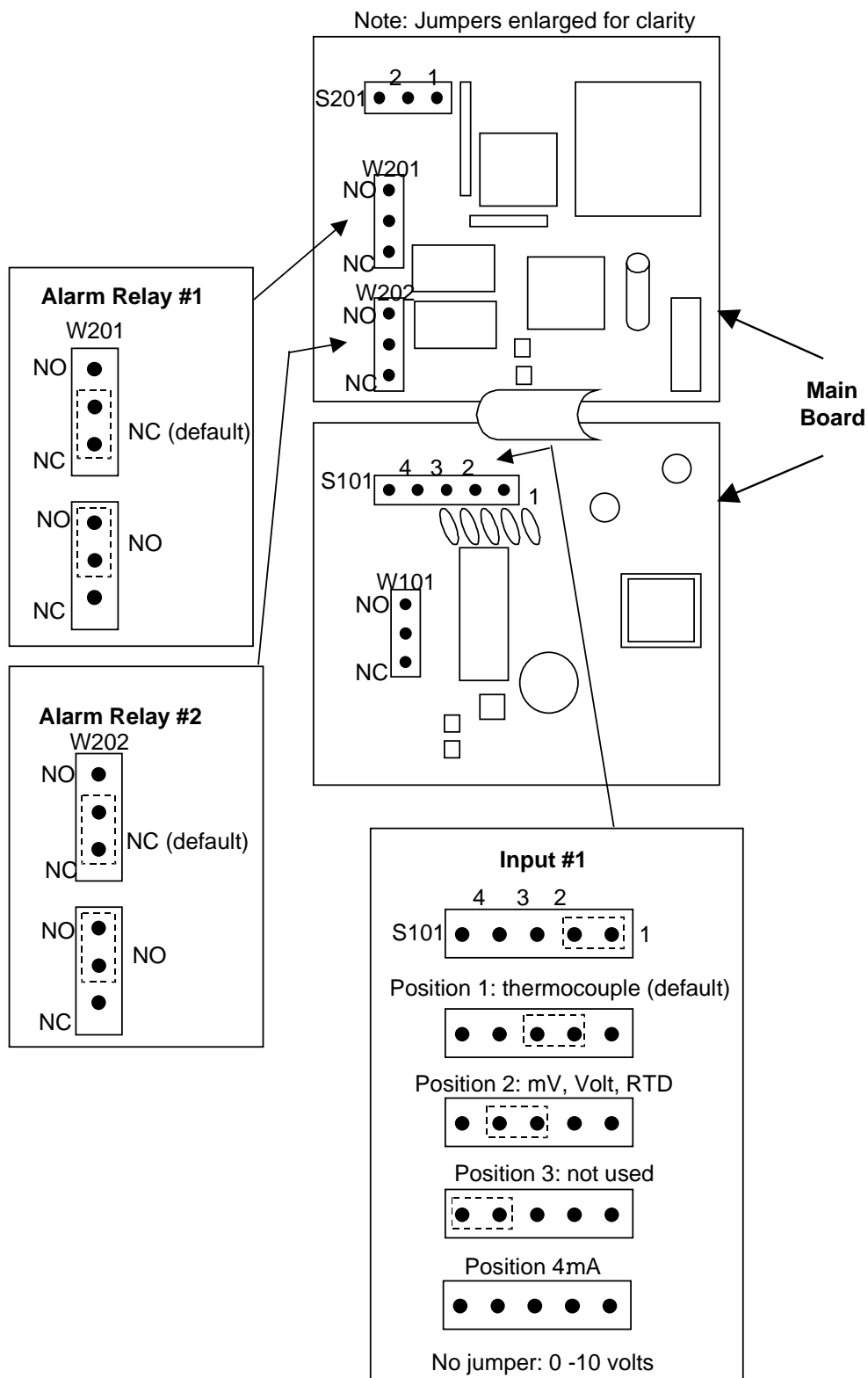

Figure 2-2 Jumper Placements

2.4 Alarm Relay Contact Information

Alarm Relays

NOTICE

Alarm relays are designed to operate in a failsafe mode (that is, de-energized during alarm state). This results in alarm actuation when power is OFF or when initially applied, until the unit completes self diagnostics. If power is lost to the unit, the alarms will function.

Table 2-3 Alarm Relay Contact Information

Unit Power	Alarm Relay Wiring	Variable NOT in Alarm State		Variable in Alarm State	
		Relay Contact	Indicators	Relay Contact	Indicators
Off	N.O.	Open	Off	Open	Off
	N.C.	Closed		Closed	
On	N.O.	Closed	Off	Open	On
	N.C.	Open		Closed	

2.5 Mounting

Physical Considerations

The indicator can be mounted on either a vertical or tilted panel using the mounting kit supplied. Adequate access space must be available at the back of the panel for installation and servicing activities.

- Overall dimensions and panel cutout requirements for mounting the indicator are shown in Figure 2-3.
- The indicator's mounting enclosure must be grounded according to CSA standard C22.2 No. 0.4 or Factory Mutual Class No. 3820 paragraph 6.1.5.
- The front panel is moisture rated NEMA 3/IP65 (IEC) when properly installed with panel gasket.

Overall Dimensions

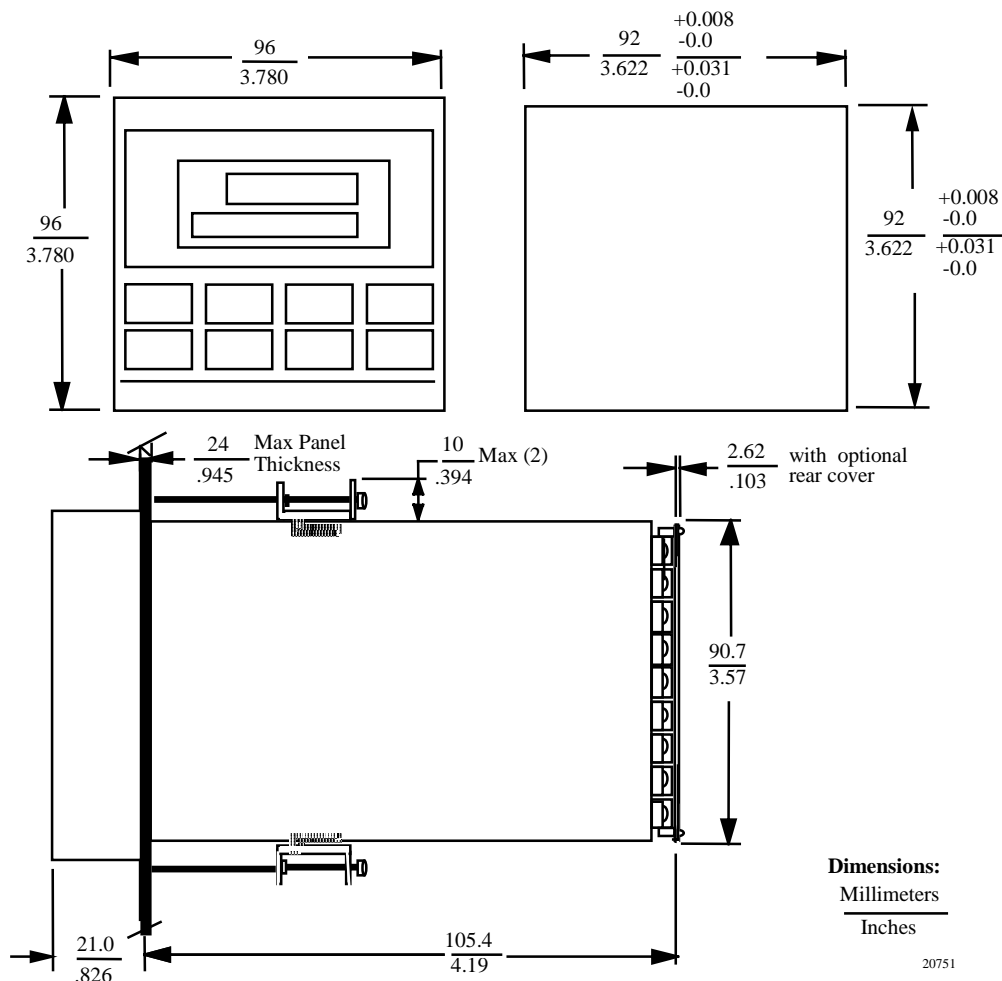

Figure 2-3 Mounting Dimensions (not to scale)

Mounting Method

Before mounting the indicator, refer to the nameplate on the outside of the case and make a note of the model number. It will help later when selecting the proper wiring configuration.

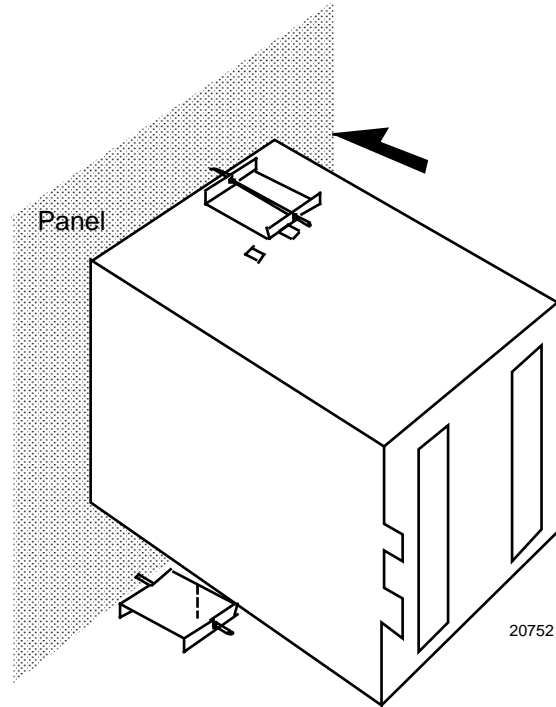

Figure 2-4 Mounting Method

Mounting Procedure

Table 2-4 Mounting Procedure

Step	Action
1	Mark and cut out the indicator hole in the panel according to the dimension information in Figure 2-3.
2	Remove the screw cover and loosen the screw on the front of the indicator. Pull the chassis out of the case.
3	Orient the case properly and slide it through the panel hole from the front.
4	Remove the mounting kit from the shipping container and install the kit as follows: <ul style="list-style-type: none"> <li data-bbox="402 1602 1068 1633">• Install the screws into the threaded holes of the clips. <li data-bbox="402 1654 1393 1686">• Insert the prongs of the clips into the two holes in the top and bottom of the case. <li data-bbox="402 1707 1125 1738">• Tighten both screws to secure the case against the panel. <li data-bbox="402 1759 1401 1824">• Carefully slide the chassis assembly into the case, press to close, and tighten the screw. Replace the screw cover.

2.6 Wiring

Electrical Considerations



The indicator is considered “rack and panel mounted equipment” per EN61010-1, Safety Requirements for Electrical Equipment for Measurement, Control, and Laboratory Use, Part 1: General Requirements. Conformity with 72/23/EEC, the Low Voltage Directive requires the user to provide adequate protection against a shock hazard. The user shall install this indicator in an enclosure that limits OPERATOR access to the rear terminals.

Mains Power Supply

This equipment is suitable for connection to 90 Vac to 264 Vac, 50/60 Hz, power supply mains. It is the user’s responsibility to provide a switch and non-time delay (North America), quick-acting, high breaking capacity, Type F (Europe), 1/2 A, 250 V fuse(s), or circuit-breaker, as part of the installation. The switch or circuit-breaker shall be located in close proximity to the indicator, within easy reach of the OPERATOR. The switch or circuit-breaker shall be marked as the disconnecting device for the indicator.

Indicator Grounding

PROTECTIVE BONDING (grounding) of this indicator and the enclosure in which it is installed shall be in accordance with National and Local electrical codes. To minimize electrical noise and transients that may adversely affect the system, supplementary bonding of the indicator enclosure to a local ground, using a No. 12 (4 mm²) copper conductor, is recommended.

Alarm Circuit Wiring

The insulation of wires connected to the Alarm terminals shall be rated for the highest voltage involved. Extra Low Voltage (ELV) wiring (input, and low voltage Alarm circuits) shall be separated from HAZARDOUS LIVE (>30 Vac, 42.4 V_{peak}, or 60 V_{dc}) wiring per Permissible Wiring Bundling, Table 2-5.

Electrical Noise Precautions

Electrical noise is composed of unabated electrical signals which produce undesirable effects in measurements and control circuits.

Digital equipment is especially sensitive to the effects of electrical noise. Your indicator has built-in circuits to reduce the effect of electrical noise from various sources. If there is a need to further reduce these effects:

- *Separate External Wiring*—Separate connecting wires into bundles (See Permissible Wiring Bundling - Table 2-5) and route the individual bundles through separate conduit metal trays.
Use Suppression Devices—For additional noise protection, you may want to add suppression devices at the external source. Appropriate suppression devices are commercially available.

NOTICE

For additional noise information, refer to Document #51-52-05-01, *How to Apply Digital Instrumentation in Severe Electrical Noise Environments*.

Permissible Wiring Bundling

Table 2-5 Permissible Wiring Bundling

Bundle No.	Wire Functions
1	<ul style="list-style-type: none"> • Line power wiring • Earth ground wiring • Line voltage alarm wiring
2	<p>Analog signal wire, such as:</p> <ul style="list-style-type: none"> • Input signal wire (thermocouple, 4 to 20 mA, etc.)
3	<ul style="list-style-type: none"> • Low voltage alarm relay output wiring

2.7 Wiring Diagrams

Identify Your Wiring Requirements

To determine the appropriate diagrams for wiring your indicator, refer to the model number interpretation in this section. The model number of the indicator can be found on the outside of the case.

Wiring the Indicator

Using the information contained in the model number, select the appropriate wiring diagrams from the composite wiring diagram below. Refer to the individual diagrams listed to wire the indicator according to your requirements.

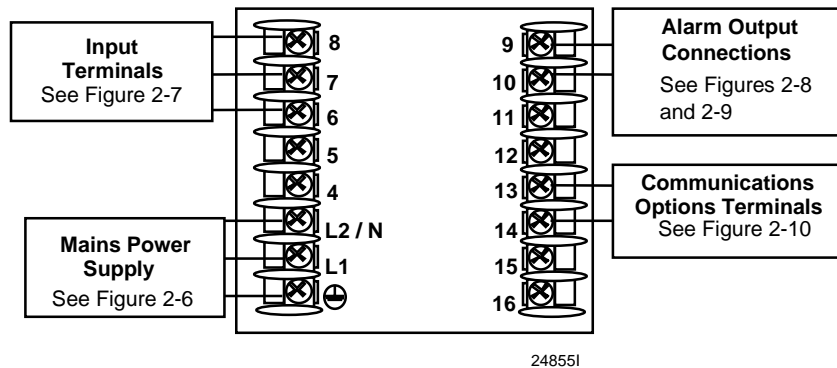
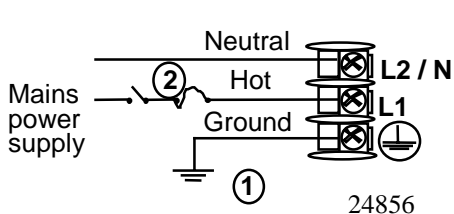

Figure 2-5 Composite Wiring Diagram



① PROTECTIVE BONDING (grounding) of this indicator and the enclosure in which it is installed, shall be in accordance with National and Local electrical codes. To minimize electrical noise and transients that may adversely affect the system, supplementary bonding of the indicator enclosure to a local ground, using a No. 12 (4 mm²) copper conductor, is recommended. **Before powering the indicator, see “Preliminary Checks” in this section of the Product manual for switch and jumper settings.**

② Provide a switch and non-time delay (North America), quick-acting, high breaking capacity, type F (Europe), 1/2 A, 250 V fuse(s), or circuit-breaker as part of the installation.

Figure 2-6 Mains Power Supply

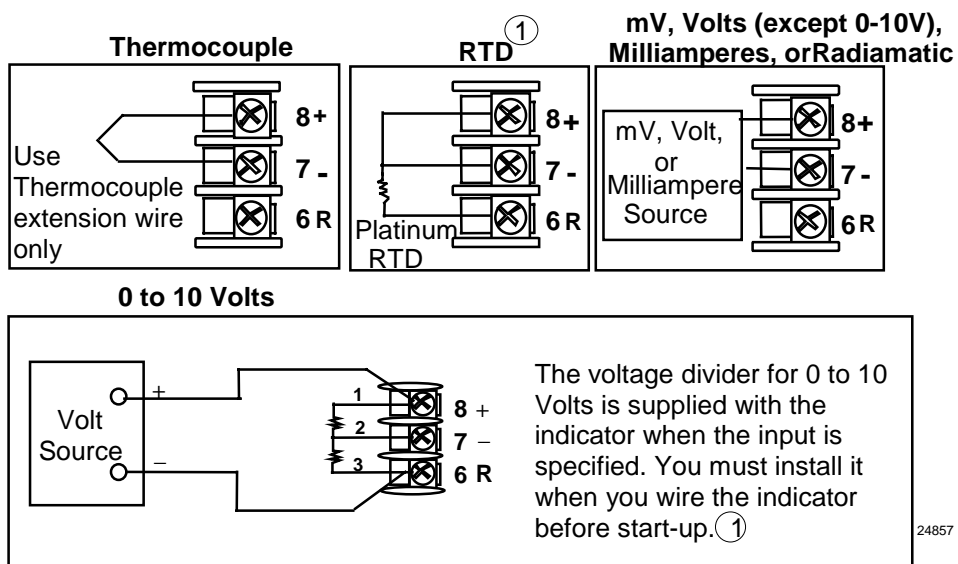

① These inputs are wired differently than the UDC2000

Figure 2-7 Input Connections

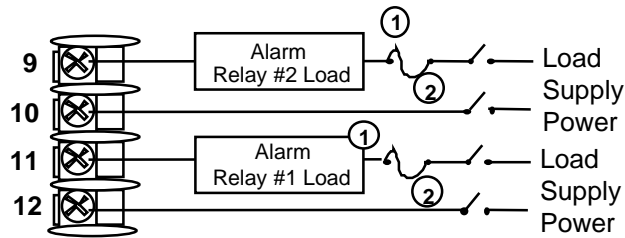

- ① Alarm relays 1 and 2 are configured N.C. as shipped. N.O. or N.C. configurations are selectable by jumpers on the I/O and Transformer/Option printed wiring boards. See "Preliminary Checks" in this section of the Product Manual for details.
- ② 5 Amp fast blo or 1 Amp fast blo
The SPST relay is rated at 5 A, 120 Vac and 30 Vdc, 2.5 A, 240 Vac, or 1 Amp SS Relay is rated at 1 Amp at 25°C, linearly derated to 0.5 Amp at 55°C.

248671

Figure 2-8 Alarm Relay Output Connections

Customer Supplied External Electromechanical Relay

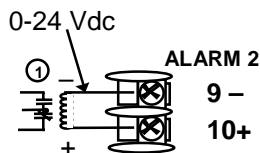

Customer Supplied External Solid State Relay

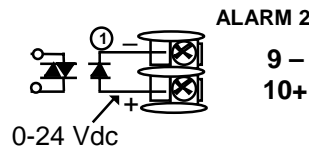

24861IND

- ① **CAUTION** Open collector outputs are internally powered at 24 Vdc. Connecting an external supply will damage the indicator. External relays should be fused between power and relay load.

Figure 2-9 Open Collector Alarm Relay Output

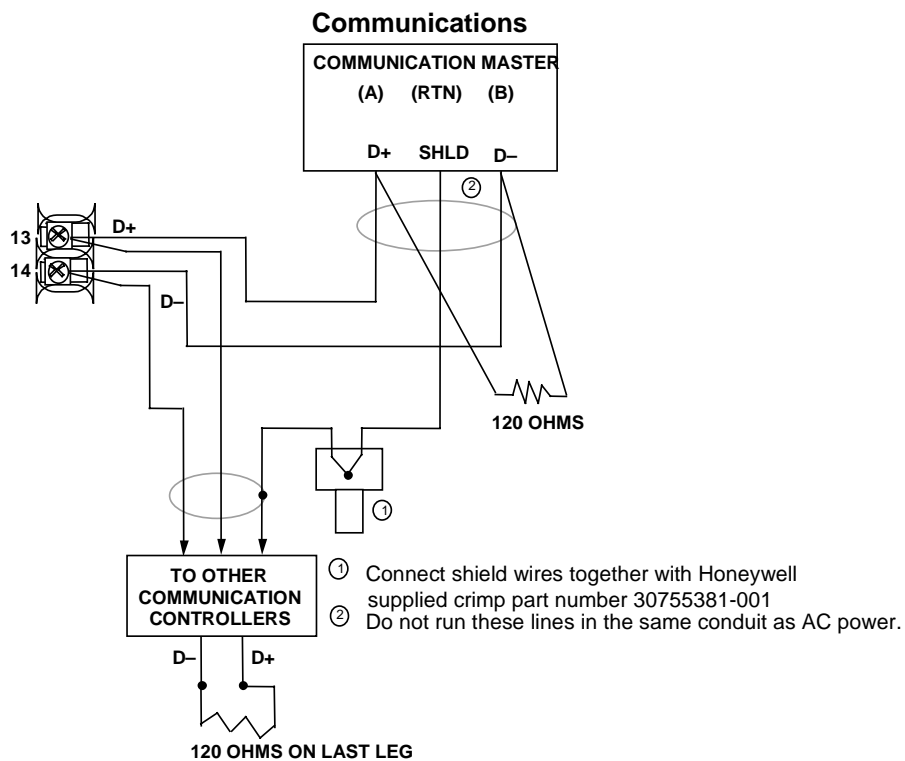

Figure 2-10 External Interface Option Connections

3 Initial Start-up

3.1 Overview

This section gives you the information necessary to start up your indicator prior to configuration. Review the Operator Interface portion to make sure you are familiar with the indicator definitions and key functions.

3.2 Powering Up the Indicator

Apply Power

When power is applied, the indicator will run three diagnostic tests. After these tests are completed, “TEST DONE” is displayed.

Test Failures

If one or more of these tests fail, the indicator will go to the Failsafe Manual Mode, and FAILSF will flash in the lower display and a message indicating which test failed will appear in the lower display. Then, “DONE” will appear in the lower display.

3.3 Operator Interface and Key Functions

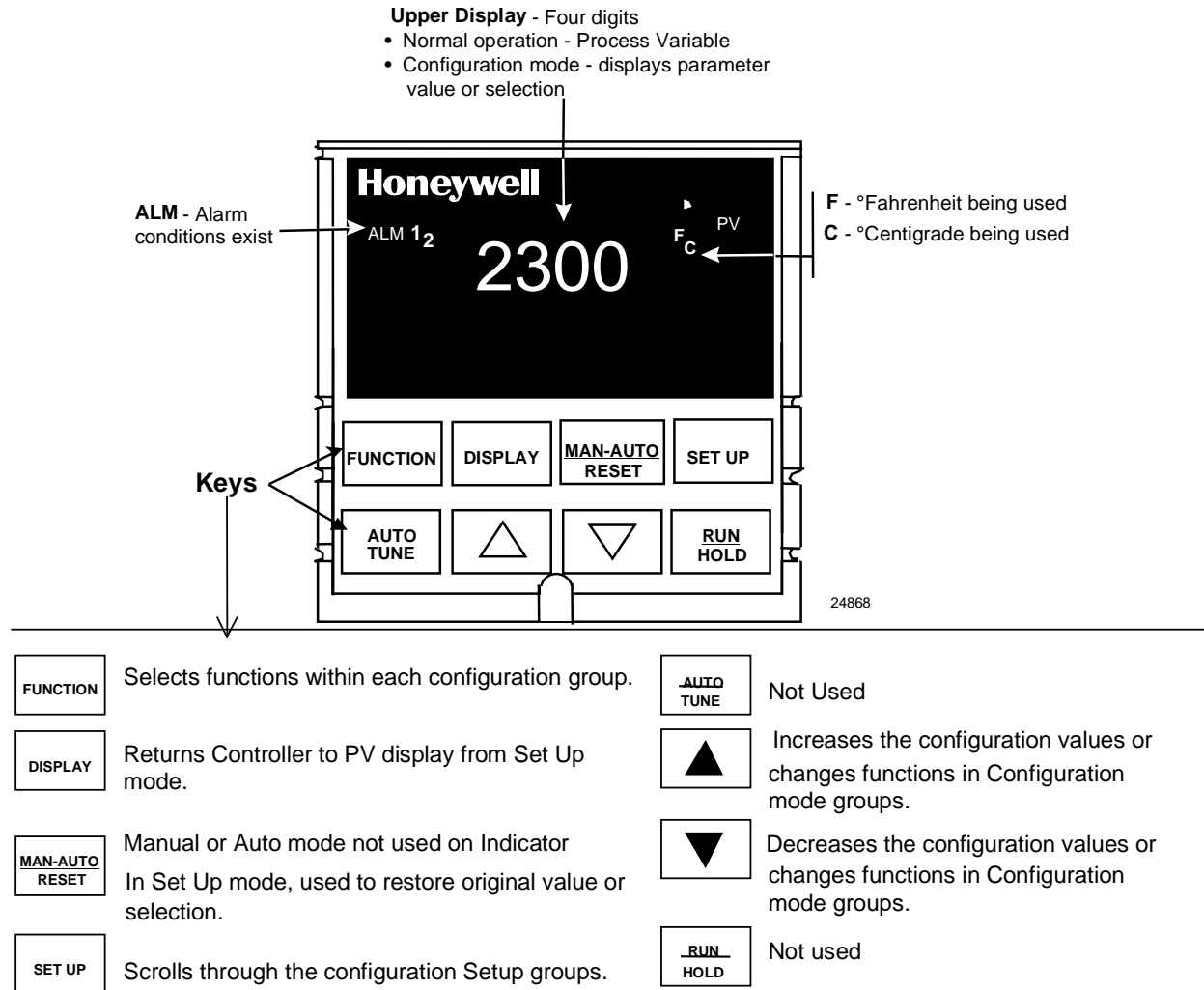

Figure 3-1 Operator Interface and Key Functions

3.4 Key Error Message

When a key is pressed and the prompt KEYERR appears in the lower display, it will be for one of the following reasons:

- parameter is not available,
- not in Set Up mode, press **[SET UP]** key first,
- key malfunction.

4 Configuration

4.1 Overview

Introduction

Configuration is a dedicated operation where you use straightforward keystroke sequences to select and establish (configure) pertinent data best suited for your application.

To assist you in the configuration process, there are prompts that appear in the upper and lower displays. These prompts let you know what group of configuration data (Set Up prompts) you are working with and also, the specific parameters (Function prompts) associated with each group.

Figure 3-1 shows you an overview of the prompt hierarchy as they appear in the Indicator.

As you will see, the configuration data is divided into 4 main Set Up groups plus prompts for calibration and prompts that show the status of the continuous background tests that are being performed.

What's in this section?

The following topics are covered in this section.

TOPIC	See Page
4.1 Overview	19
4.2 Configuration Prompt Hierarchy	20
4.3 Configuration Procedure	21
4.4 Lock Set Up Group	22
4.5 Input 1 Set Up Group	23
4.6 Communications Set Up Group	27
4.7 Alarms Set Up Group	30
4.8 Configuration Record Sheet	32

4.2 Configuration Prompt Hierarchy

Table 4-1 Configuration Prompt Hierarchy

Set Up Group	Function Prompts
LOCK	<div style="display: flex; align-items: center;"> ▶ <div style="display: flex; gap: 10px;"> <div style="border: 1px solid black; padding: 2px 5px;">SECUR</div> <div style="border: 1px solid black; padding: 2px 5px;">LOCK</div> </div> </div>
INPUT1	<div style="display: flex; align-items: center;"> ▶ <div style="display: flex; gap: 10px;"> <div style="border: 1px solid black; padding: 2px 5px;">DECIMAL</div> <div style="border: 1px solid black; padding: 2px 5px;">UNITS</div> <div style="border: 1px solid black; padding: 2px 5px;">IN1TYP</div> <div style="border: 1px solid black; padding: 2px 5px;">XMITR1</div> <div style="border: 1px solid black; padding: 2px 5px;">IN1 HI</div> <div style="border: 1px solid black; padding: 2px 5px;">IN1 LO</div> <div style="border: 1px solid black; padding: 2px 5px;">RATIO1</div> <div style="border: 1px solid black; padding: 2px 5px;">BIAS 1</div> </div> ◀ </div> <div style="display: flex; align-items: center;"> ▶ <div style="display: flex; gap: 10px;"> <div style="border: 1px solid black; padding: 2px 5px;">FILTR1</div> <div style="border: 1px solid black; padding: 2px 5px;">BRNOUT</div> <div style="border: 1px solid black; padding: 2px 5px;">EMISS</div> <div style="border: 1px solid black; padding: 2px 5px;">FREQ</div> <div style="border: 1px solid black; padding: 2px 5px;">LNGUAG</div> </div> </div>
COM	<div style="display: flex; align-items: center;"> ▶ <div style="display: flex; gap: 10px;"> <div style="border: 1px solid black; padding: 2px 5px;">ComSTA</div> <div style="border: 1px solid black; padding: 2px 5px;">ComADR</div> <div style="border: 1px solid black; padding: 2px 5px;">SDENAB</div> <div style="border: 1px solid black; padding: 2px 5px;">SHDTIM</div> <div style="border: 1px solid black; padding: 2px 5px;">PARITY</div> <div style="border: 1px solid black; padding: 2px 5px;">BAUD</div> <div style="border: 1px solid black; padding: 2px 5px;">TX DLY</div> <div style="border: 1px solid black; padding: 2px 5px;">WS FLT</div> </div> ◀ </div> <div style="display: flex; align-items: center;"> ▶ <div style="display: flex; gap: 10px;"> <div style="border: 1px solid black; padding: 2px 5px;">UNITS</div> <div style="border: 1px solid black; padding: 2px 5px;">LOOPBK</div> </div> </div>
ALARMS	<div style="display: flex; align-items: center;"> ▶ <div style="display: flex; gap: 10px;"> <div style="border: 1px solid black; padding: 2px 5px;">A1S1VA</div> <div style="border: 1px solid black; padding: 2px 5px;">A1S2VA</div> <div style="border: 1px solid black; padding: 2px 5px;">A2S1VA</div> <div style="border: 1px solid black; padding: 2px 5px;">A2S2VA</div> <div style="border: 1px solid black; padding: 2px 5px;">A1S1TY</div> <div style="border: 1px solid black; padding: 2px 5px;">A1S2TY</div> <div style="border: 1px solid black; padding: 2px 5px;">A2S1TY</div> <div style="border: 1px solid black; padding: 2px 5px;">A2S2TY</div> </div> ◀ </div> <div style="display: flex; align-items: center;"> ▶ <div style="display: flex; gap: 10px;"> <div style="border: 1px solid black; padding: 2px 5px;">A1S1HL</div> <div style="border: 1px solid black; padding: 2px 5px;">A1S2HL</div> <div style="border: 1px solid black; padding: 2px 5px;">A2S1HL</div> <div style="border: 1px solid black; padding: 2px 5px;">A2S2HL</div> <div style="border: 1px solid black; padding: 2px 5px;">ALHYST</div> <div style="border: 1px solid black; padding: 2px 5px;">ALARM1</div> <div style="border: 1px solid black; padding: 2px 5px;">BLOCK</div> </div> </div>
STATUS	<div style="display: flex; align-items: center;"> ▶ <div style="display: flex; gap: 10px;"> <div style="border: 1px solid black; padding: 2px 5px;">VERSON</div> <div style="border: 1px solid black; padding: 2px 5px;">FAILSF</div> <div style="border: 1px solid black; padding: 2px 5px;">TESTS</div> </div> </div>

4.3 Configuration Procedure

Introduction

Each of the Set Up groups and their functions are pre-configured at the factory. The factory settings are shown in Table 4-3 through Table 4-6 that follow this procedure. If you want to change any of these selections or values, follow the procedure in Table 4-2. This procedure tells you the keys to press to get to any Set Up group and any associated Function parameter prompt.

Procedure

NOTICE

The prompting scrolls at a rate of 2/3 seconds when the **[SET UP]** or **[FUNCTION]** key is held in. Also, **[▲]** **[▼]** keys will move group prompts forward or backward at a rate twice as fast.

Table 4-2 Configuration Procedure

Step	Operation	Press	Result
1	Enter Set Up Mode	SET UP	<i>Upper Display = SET</i> <i>Lower Display = LOCK</i> (This is the first Set Up Group title)
2	Select any Set Up Group	SET UP	Sequentially displays the other Set Up group titles shown in the prompt hierarchy in Table 4-1. You can also use the [▲] [▼] keys to scan the Set Up groups in both directions. Stop at the Set Up group title that describes the group of parameters you want to configure. Then proceed to the next step.
3	Select a Function Parameter	FUNCTION	<i>Upper Display =</i> the current value or selection for the first function prompt of the selected Set Up group. <i>Lower Display =</i> the first Function prompt within that Set Up group. Sequentially displays the other function prompts of the Set Up group you have selected. Stop at the function prompt that you want to change, then proceed to the next step.
4	Change the Value or Selection	[▲] [▼]	Increments or decrements the value or selection that appears for the selected function prompt. If you change the value or selection of a parameter while in Set Up mode then decide not to enter it, press [MAN-AUTO/RESET] once—the original value or selection is recalled.
5	Enter the Value or Selection	FUNCTION	Enters value or selection made into memory after another key is pressed.
6	Exit Configuration	DISPLAY	Exits configuration mode and returns indicator to the same state it was in immediately preceding entry into the Set Up mode. It stores any changes you have made. If you do not press any keys for 30 seconds, the indicator times out and reverts to the mode and display used prior to entry into Set Up mode.

4.4 Lock Set Up Group

Introduction

The Lock Set Up group contains the Function parameters that will allow your indicator to protect Configuration and Calibration data.

Because this group contains functions that have to do with Security and Lockout, it is best to configure this group last, after all the other configuration data has been loaded.

Function Prompts

Table 4-3 LOCK Group (Numeric Code 200) Function Prompts

Prompt English	Numeric Code	Description	Selection or Range of Setting		Factory Setting										
SECUR	210	Security Code	0 to 4095 When "Lock" is none, this number is displayed and can be changed using the raise/lower keys		DIS										
			<table border="1"> <thead> <tr> <th>Numeric Code</th> <th>English</th> </tr> </thead> <tbody> <tr> <td>0</td> <td>NONE – all parameters are read/write</td> </tr> <tr> <td>1</td> <td>CAL - all parameters are read/write except Calibration</td> </tr> <tr> <td>2</td> <td>CONF – Lockout is available for Read/Write, other configuration parameters are Read Only</td> </tr> <tr> <td>4</td> <td>ALL – Only the Lockout group is available for read/write. No other parameters are viewable.</td> </tr> </tbody> </table>		Numeric Code	English	0	NONE – all parameters are read/write	1	CAL - all parameters are read/write except Calibration	2	CONF – Lockout is available for Read/Write, other configuration parameters are Read Only	4	ALL – Only the Lockout group is available for read/write. No other parameters are viewable.	
Numeric Code	English														
0	NONE – all parameters are read/write														
1	CAL - all parameters are read/write except Calibration														
2	CONF – Lockout is available for Read/Write, other configuration parameters are Read Only														
4	ALL – Only the Lockout group is available for read/write. No other parameters are viewable.														
LOCK	211	Configuration Lockout			CAL										

4.5 Input Set Up Group

Introduction

This data deals with various parameters required to configure the Input.

Function Prompts

Table 4-4 INPUT Group (Numeric Code 600) Function Prompts

Prompt English	Numeric Code	Description	Selection or Range of Setting		Factory Setting		
			Numeric	English			
DECIMAL	601	Decimal Point Selection	This selection determines where the decimal point appears in the display.		8888		
			0	8888 (none)			
			1	888.8			
			2	88.88			
UNITS	602	Temperature Units	This selection will be indicated on the annunciator. ("What display of temperature do you want?")		F		
			1	F			
			2	C			
			0	NONE			
IN1TYP	603	Input 1 Actuation Type			K H		

Prompt English	Numeric Code	Description	Selection or Range of Setting				Factory Setting
			Numeric	English	Numeric	English	
XMITR1	604	Transmitter Characterization <i>Available on Linear actuations only.</i>	0	B	13	S	LIN
			1	E H	14	T H	
			2	E L	15	T L	
			3	J H	16	W H	
			4	J L	17	W L	
			5	K H	18	100H	
			6	K L	19	100L	
			7	NNMH	20	200	
			8	NNML	21	500	
			9	N90H	22	RADH	
			10	N90L	23	RADI	
			11	NIC	24	LIN	
			12	R	25	SrT	
IN1 HI	605	Input High Range Value	This selection lets you the Input high range value in engineering units. Linear or Square Root Inputs only. Scale the input signal to the display value you want for 100 %. EXAMPLE: Actuation (Input) = 4 mA to 20 mA Process Variable = Flow Range of Flow = 0 to 250 Gal/Min High Range display value = 250 Then 20 mA = 250 Gal/Min Range of Setting: -999 to 9999. floating in engineering units				2400
IN1 LO	606	Input Low Range Value	This selection lets you the Input low range value in engineering units. Linear or Square Root Inputs only. Scale the input signal to the display value you want for 0 %. EXAMPLE: Actuation (Input) = 4 mA to 20 mA Process Variable = Flow Range of Flow = 0 to 250 Gal/Min Low Range display value = 0 Then 4 mA = 0 Gal/Min Range of Setting: -999 to 9999 floating in Engineering Units				0
RATIO1	607	Ratio on Input	Select the Ratio value you want on the Input. Range of Setting: -20.0 to 20.0				0.0

Prompt English	Numeric Code	Description	Selection or Range of Setting		Factory Setting
			Numeric	English	
BIAS 1	608	Bias on Input	Bias is used to compensate the input for drift of an input value due to deterioration of a sensor, or some other cause. Select the bias value you want on the Input. Range of Setting: –999 to 9999 (Engineering Units)		0.0
FILTR1	609	Filter for Input	A software digital filter is provided for the input to smooth the input signal. You can configure the first order lag time constant from 1 to 120 seconds Range of Setting: 0 to 120 seconds 0 = No Filter		1.0
BRNOUT	610	Burnout Protection (Sensor Break)	<p>BURNOUT PROTECTION (SENSOR BREAK) provides most input types with upscale or downscale protection if the input fails. 1-5 V, 0-10 V, or 4-20 mA inputs require no burnout or NONE selection.</p> <p>0 NONE - Pre-configured Failsafe output applied if failed input is detected (does not apply for an input out of range). Error message IN1FL is flashed on the lower display intermittently every 10 seconds.</p> <p>1 UP - UPSCALE BURNOUT will make the PV signal increase to full scale, +10 %, when a sensor fails, and flash IN1FL on the lower display intermittently every 10 seconds.</p> <p>2 DOWN - DOWNSCALE BURNOUT will make the PV signal decrease to the lower range value, –10 %, when a sensor fails, and flash IN1FL on the lower display intermittently every 10 seconds.</p> <p>3 NOFS - NO FAILSAFE —This selection does not provide input failure detection and should only be used when an absolute accuracy is the most important criteria. (For this selection, no burnout signal went to the sensor.)</p>		8888

Configuration

Prompt English	Numeric Code	Description	Selection or Range of Setting		Factory Setting
			Numeric	English	
EMISS	611	Emissivity	<p>Emissivity is a correction factor applied to the Radiamatic input signal that is the ratio of the actual energy emitted from the target to the energy which would be emitted if the target were a perfect radiator.</p> <p>Range of Setting: 0.01 to 1.00 (RADH and RADJ only)</p>		1.0
FREQ	612	Power Line Frequency	<p>0 1</p>	<p>Select whether your indicator is operating at 60 Hz or 50 Hz.</p> <p>60 50</p>	1.0
<div style="border: 1px solid black; padding: 5px; width: fit-content; margin: 0 auto;"> <p>NOTICE</p> <p>For units powered by +24 Vdc, this configuration should be set to the AC Line frequency used to produce the +24 Vdc Supply. Failure to set this parameter properly can cause normal mode noise problems in the input readings.</p> </div>					
LNGUAG	614	Language Selection	<p>0 1 2 3 4 5</p>	<p>Select what the language will be for the displays.</p> <p>ENGL FREN GERM SPAN ITAL NUMB (Numeric)</p>	ENGL

4.6 Communications Set Up Group

Introduction

The Communications group lets you configure the indicator to be connected to a host computer via RS422/485 or Modbus® protocol.

Function Prompts

Table 4-5 Communications Group (Numeric Code 1000) Function Prompts

Prompt English	Numeric Code	Description	Selection or Range of Setting		Factory Setting
			Numeric	English	
COMSTA	1001	Communica- tions State	0	DIS Disable	DIS
			1	R422 RS-422/485	
			2	MODB Modbus	
ComADD	1002	Station Address	This is a number that is assigned to a indicator that is to be used with the communications option. This number will be its address. <i>Range of Setting:</i> 1 to 99		0
SDENAB	1003	Shed Enable	This selection enables/disables the Communications Shed feature.		ENAB
			0	DIS Disable	
			1	ENAB Enable	
SHDTIM	1004	Shed Time	This is the number that represents how many sample periods there will be before the indicator sheds from communications. Each period equals 1/3 seconds; 0 equals No shed. <i>Range of Setting:</i> 0 to 255 Sample Periods		0
PARITY	1005	Parity	PARITY pertains to the use of a self-checking code employing binary digits in which the total number of ONE's (or ZERO's) in each permissible code expression is either		ODD
			0	ODD or	
			1	EVEN	
BAUD	1006	Baud Rate	BAUD RATE is the transmission speed in bits per second		2400
			0	2400 Baud	
			1	4800 Baud	
			2	9600 Baud	
			3	19200 Baud	

Prompt English	Numeric Code	Description	Selection or Range of Setting		Factory Setting																																																							
			Numeric	English																																																								
TX_DLY	1007	Response Delay	Configurable response-delay timer allows you to force the UDC to delay its response for a time period of from 1 to 500 milliseconds compatible with the host system hardware/software. Range of Setting: 1 to 500 milliseconds		1																																																							
WS_FLT	1008	Word/Byte Order for floating point communications data	<table border="0"> <tr> <td></td> <td><u>Byte</u></td> <td><u>Contents</u></td> <td></td> </tr> <tr> <td></td> <td>0</td> <td>seeeeeee</td> <td></td> </tr> <tr> <td></td> <td>1</td> <td>emmmmmm</td> <td></td> </tr> <tr> <td></td> <td>2</td> <td>mmmmmmm</td> <td></td> </tr> <tr> <td></td> <td>3</td> <td>mmmmmmm</td> <td></td> </tr> <tr> <td></td> <td><u>Choice</u></td> <td><u>Byte Order</u></td> <td></td> </tr> <tr> <td></td> <td>FP_B</td> <td>0123</td> <td></td> </tr> <tr> <td></td> <td>FPBB</td> <td>1032</td> <td></td> </tr> <tr> <td></td> <td>FP_L</td> <td>3210</td> <td></td> </tr> <tr> <td></td> <td>FPLB</td> <td>2301</td> <td></td> </tr> <tr> <td></td> <td>0</td> <td>FP_B</td> <td>Floating point big endian</td> </tr> <tr> <td></td> <td>1</td> <td>FPBB</td> <td>Floating point big endian with byte-swapped</td> </tr> <tr> <td></td> <td>2</td> <td>FP_L</td> <td>Floating point little endian</td> </tr> <tr> <td></td> <td>3</td> <td>FPLB</td> <td>Floating point little endian with byte-swapped</td> </tr> </table>		<u>Byte</u>	<u>Contents</u>			0	seeeeeee			1	emmmmmm			2	mmmmmmm			3	mmmmmmm			<u>Choice</u>	<u>Byte Order</u>			FP_B	0123			FPBB	1032			FP_L	3210			FPLB	2301			0	FP_B	Floating point big endian		1	FPBB	Floating point big endian with byte-swapped		2	FP_L	Floating point little endian		3	FPLB	Floating point little endian with byte-swapped	FP_B
	<u>Byte</u>	<u>Contents</u>																																																										
	0	seeeeeee																																																										
	1	emmmmmm																																																										
	2	mmmmmmm																																																										
	3	mmmmmmm																																																										
	<u>Choice</u>	<u>Byte Order</u>																																																										
	FP_B	0123																																																										
	FPBB	1032																																																										
	FP_L	3210																																																										
	FPLB	2301																																																										
	0	FP_B	Floating point big endian																																																									
	1	FPBB	Floating point big endian with byte-swapped																																																									
	2	FP_L	Floating point little endian																																																									
	3	FPLB	Floating point little endian with byte-swapped																																																									
UNITS	1010	Communications Override Units	<table border="0"> <tr> <td></td> <td>0</td> <td>PCT</td> <td>Percent</td> </tr> <tr> <td></td> <td>1</td> <td>Eng</td> <td>Engineering Units</td> </tr> </table>			0	PCT	Percent		1	Eng	Engineering Units	ODD																																															
	0	PCT	Percent																																																									
	1	Eng	Engineering Units																																																									

Prompt English	Numeric Code	Description	Selection or Range of Setting		Factory Setting
			Numeric	English	
LOOPBK	1013	Local Loopback Test		Allows loopback test. The UDC goes into Loopback mode in which it sends and receives its own message. The UDC displays PASS or FAIL status in the upper display and LOOPBACK in the lower display while the test is running. The UDC will go into manual mode. The test will run until the operator disables it here, or until power is turned off and on.	DIS
<div style="border: 1px solid black; padding: 5px; margin: 10px 0;"> <p>NOTICE</p> <p>The UDC does not have to be connected to the RS-485 link to perform this test. If it is connected, only one UDC2300 should run the loopback test at a time. The computer should not be transmitting on the link while the loopback test is active.</p> </div>					
			0	DIS Disable	
			1	EnAB Enable	

4.7 Alarms Set Up Group

Introduction

An alarm is an indication that an event that you have configured (for example—Process Variable) has exceeded one or more alarm limits. There are two alarms available. Each alarm has two setpoints. You can configure each of these two setpoints to alarm on various indicator parameters.

There are two alarm output selections, High and Low. You can configure each setpoint to alarm either High or Low. These are called single alarms.

You can also configure the two setpoints to alarm on the same event and to alarm both high and low. A single adjustable Hysteresis of 0 to 100% is configurable for the alarm setpoint.

See Table 2-3 in the Installation section for Alarm relay contact information.

The prompts for the Alarm Outputs appear whether or not the alarm relays are physically present. This allows the Alarm status to be shown on the display and/or sent via communications to a host computer.

Function Prompts

Table 4-6 ALARMS Group (Numeric Code 1100) Function Prompts

Prompt English	Numeric Code	Description	Selection or Range of Setting		Factory Setting
			Numeric	English	
AxSxVA		Alarmx	This is the value at which you want the alarm type chosen in Prompt "AxSxTY" to actuate.		90
A1S1	1101	Setpointx	The value depends on what the alarm setpoint has been configured to represent.		
A1S2	1102	Value			
A2S1	1103	X = 1 or 2			
A2S2	1104				
			Range of Setting: within the range of the selected parameter		
AxSxTY		Alarmx	Select what you want Setpoint x of Alarm x to represent; it can represent the Process Variable or Deviation.		NONE
A1S1	1105	Setpointx			
A1S2	1106	Type			
A2S1	1107	X = 1 or 2			
A2S2	1108				
			0	NONE No Alarm	
			3	PROC Process Variable	
			6	SHED Shed Communications	
			12	PrRT PV Rate of Change	
AxSxHL		Alarmx	Select whether you want the alarm type chosen in prompt "AxSxTY" to alarm High or Low.		HIGH
A1S1	1109	Setpoint x			
A1S2	1110	State			
A2S1	1111	X = 1 or 2			
A2S2	1112				
			0	LOW Low Alarm	
			1	HIGH High Alarm	

Prompt English	Numeric Code	Description	Selection or Range of Setting		Factory Setting
			Numeric	English	
ALHYST	1113	Alarm Hysteresis	<p>A single adjustable hysteresis is provided on alarms such that when the alarm is OFF it activates at exactly the alarm setpoint; when the alarm is ON, it will not deactivate until the variable is 0.0 % to 100 % away from the alarm setpoint.</p> <p>Configure the hysteresis of the alarms based on INPUT signals as a % of input range span.</p> <p>Range of Setting: 0.0 % to 100.0 % of span</p>		0.0
ALARM1	1114	Latching Alarm Output	<p>When configured for latching, the alarm will stay on, after the alarm condition ends, until the [RUN/HOLD] key is pressed.</p> <p>0 NO L Non Latching 1 LACH Latching</p>		HIGH
BLOCK	1115	Alarm Blocking	<p>Alarm Blocking prevents nuisance alarms when the indicator is first powered up. The alarm is suppressed until the parameter gets to the non-alarm limit or band. Alarm blocking affects both alarm setpoints.</p> <p>0 DIS Disable Blocking 1 BK1 Block Alarm 1 only 2 BK2 Block Alarm 2 only 3 BK12 Blocks both Alarms</p>		DIS

4.8 Configuration Record Sheet

Enter the value or selection for each prompt on this sheet so you will have a record of how your indicator was configured.

Group Prompt	Function Prompt	Value or Selection	Factory Setting	Group Prompt	Function Prompt	Value or Selection	Factory Setting
LOCK	SECUR LOCK	_____	DIS	ALARMS	A1S1VA	_____	90
		_____	CAL		A1S2VA	_____	90
INPUT1	DECIMAL UNITS IN1TYP XMTR1 IN1 HI IN1 LO RATIO1 BIAS 1 RILTR1 BRNOUT EMIS FREQ DISPLY LNGUAG	_____	8888		A2S1VA	_____	90
		_____	DegF		A2S2VA	_____	90
		_____	KH		A1S1TY	_____	NONE
		_____	LIN		A1S1TY	_____	NONE
		_____	2400		A2S1TY	_____	NONE
		_____	0		A2S2TY	_____	NONE
		_____	1.00		A1S1HL	_____	HIGH
		_____	0.0		A1S2HL	_____	HIGH
		_____	1.0		A2S1HL	_____	HIGH
		_____	UP		A2S2HL	_____	HIGH
		_____	1.0		ALHYST	_____	0.0
		_____	60		ALARM1	_____	NOL
_____	SP	BLOCK	_____	DIS			
_____	ENGL						
COM	ComSTA ComADR SDENAB SHDTIM PARITY BAUD TX_DLY WS_FLT UNITS LOOPBACK	_____	Disable				
		_____	0				
		_____	Enable				
		_____	0				
		_____	Odd				
		_____	9600				
		_____	1				
		_____	FP_B				
		_____	PCT				
		_____	Disable				

5 Monitoring the Indicator

5.1 Overview

Introduction

This section gives you all the information necessary to help you monitor your Indicator including an Operator Interface overview, how to lockout changes to the Indicator, entering a security code, and monitoring the displays.

What's in this section?

The following topics are covered in this section.

TOPIC	See Page
5.2 Operator Interface	34
5.3 Entering A Security Code	34
5.4 Lockout Feature	35
5.5 Monitoring The Indicator	36
5.6 Alarm Setpoints	37

5.2 Operator Interface

Introduction

Figure 5-1 is a view of the Operator Interface. A description of the displays and indicators is included.

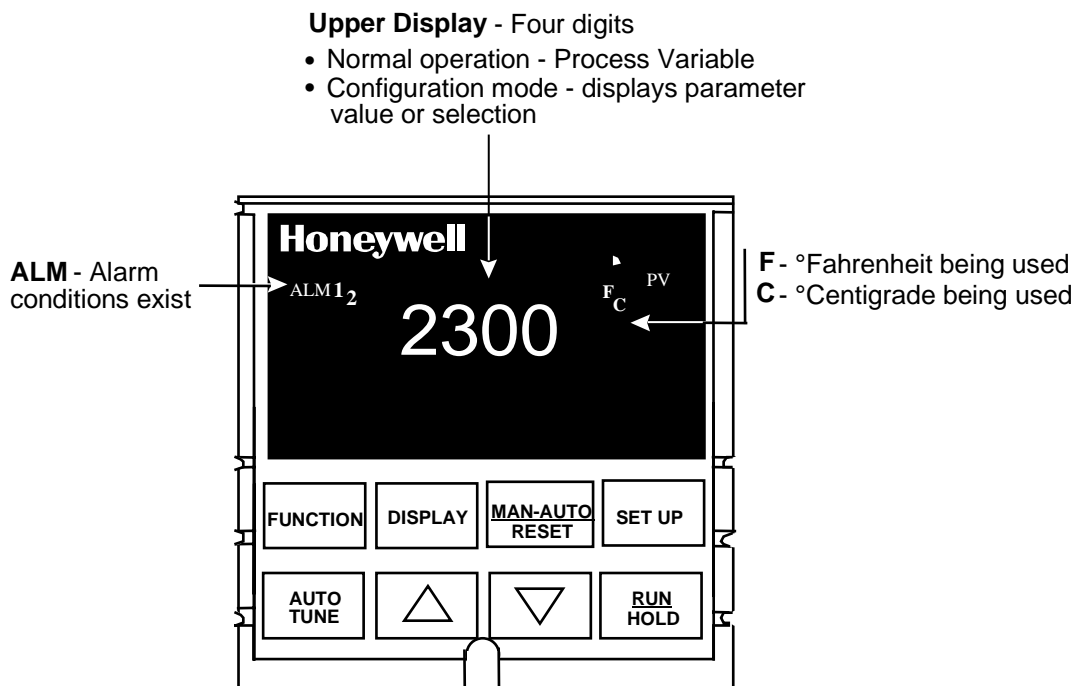

Figure 5-1 Operator Interface

5.3 Entering a Security Code

Introduction

The level of keyboard lockout may be changed in the Set Up mode. However, knowledge of a security code number (0 to 4095) may be required to change from one level of lockout to another. When an Indicator leaves the factory, it has a security code of 0 which permits changing from one lockout level to another without entering any other code number.

Procedure

If you require the use of a security code, select a number from 0001 to 4095 and enter it when the lockout level is configured as NONE. Thereafter, that selected number must be used to change the lockout level from something other than NONE.

NOTICE

Write the number on the Configuration Record Sheet in the configuration section so you will have a permanent record.

Table 5-1 Procedure to Enter a Security Code

Step	Operation	Press	Result
1	Enter Set Up Mode	SET UP	Upper Display = SET UP Lower Display = LOCK
2	Select SECUR	FUNCTION	Upper Display = 0 Lower Display = SECUR
3	Security Code Entry	[▲] [▼]	To enter a four digit number in the upper display (0001 to 4095) This will be your security code.

5.4 Lockout Feature

Introduction

The lockout feature in the UDC2300 is used to inhibit changes (via keyboard) of certain functions or parameters by unauthorized personnel.

Lockout levels

There are different levels of Lockout depending on the level of security required. These levels are:

- **NONE** No Lockout. All groups Read/Write.
- **CAL** Calibration prompts are deleted from the Setup List.
- **CONF** Configuration Parameters are read only; no writes permitted
- **VIEW** Timer, Tuning, and SP Ramp are Read/Write. No other parameters are available.
- **ALL** Only the Lockout group is available for read /write. No other parameters are viewable.

See *Subsection 4.4 - LOCK Parameters Set Up Group* prompts to select one of the above.

Security Code (*see Section 5.3*)

Key error

When a key is pressed and the prompt “Key Error” appears in the lower display, it will be for one of the following reasons:

- Parameter not available or locked out
- Not in setup mode, press **[SET UP]** key first

5.5 Monitoring Your Indicator

Annunciators

The following annunciator functions have been provided to help monitor the Indicator:

Table 5-2 Annunciators

Annunciator	Indication
ALM 1 2	<i>A visual indication of each alarm</i> Blinking 1 indicates alarm latched and needs to be acknowledged before extinguishing when the alarm condition ends
F or C	<i>A visual indication of the temperature units</i> F —Degrees Fahrenheit C —Degrees Celsius <i>The upper display is used to show other annunciator functions.</i> LOOPBK —Loopback Test running

Diagnostic Error Messages

The UDC2300 performs background tests to verify data and memory integrity. If there is a malfunction, an error message will be displayed. In the case of more than one simultaneous malfunction, the messages will be displayed sequentially on the lower display. If any of these error messages in Table 5-3 occur, refer to *Section 7 - Troubleshooting* for information to correct the failure.

Table 5-3 Error Messages

Prompt	Description
EEFAIL	Unable to write to nonvolatile memory.
IN1FL	Two consecutive failures of input 1 integration.
IN1RNG	Input 1 Out-of-Range Out-of-range criteria: Linear range: $\pm 10\%$ out-of-range Characterized range: $\pm 1\%$ out-of-range
PV LIM	PV Out-of-Range $PV = (PV \text{ source} \times PV \text{ source ratio}) + PV \text{ source bias}$
FAILSF	Failsafe — conditions for failsafe are: ... EEROM Test Failed ... Scratch Pad RAM Test Failed ... Configuration Test Failed ... Field or Factory Cal Test Failed Check the "Status" group.
LOCK	The lockout feature has been enabled to prevent unauthorized changes of certain functions or parameters.

5.6 Alarm Setpoints

Introduction

An alarm consists of a relay contact and an operator interface indication. The alarm relay is de-energized if setpoint 1 or setpoint 2 is exceeded.

The alarm relay is energized when the monitored value goes into the allowed region by more than the hysteresis.

The relay contacts can be wired for normally open (NO) energized or normally closed (NC) de-energized using internal jumper placement. See Table 2-3 in the *Section 2 – Installation* for alarm relay contact information.

There are four alarm setpoints, two for each alarm. The type and state (High or Low) is selected during configuration. See *Subsection 4.6 – Configuration* for details.

Alarm Setpoints Display

Table 5-4 Procedure for Displaying Alarm Setpoints

Step	Operation	Press	Result
1	Select Alarm Set-up Group	SET UP	Until you see: <i>Upper Display = SET</i> <i>Lower Display = ALARMS</i>
2	Access the Alarm Setpoint Values	FUNCTION	To successively display the alarm setpoints and their values. Their order of appearance is shown below. <i>Upper Display = (the alarm setpoint value)</i> <i>Range values are within the range of the selected parameters except:</i> PV RATE OF CHANGE (PVRT) = The amount of PV change in one minute in engineering units. <i>Lower Display = A1S1VA = Alarm 1, Setpoint 1</i> <i>A1S2VA = Alarm 1, Setpoint 2</i> <i>A2S1VA = Alarm 2, Setpoint 1</i> <i>A2S2VA = Alarm 2, Setpoint 2</i>
3	Change a value	[▲] [▼]	To change any alarm setpoint value in the upper display.
4	Return to Normal Display	DISPLAY	

6 Input Calibration

6.1 Overview

Introduction

This section describes the field calibration procedures for the Input.

- Every UDC2300 indicator contains all input actuation ranges which are fully factory-calibrated and ready for configuration to range by the user.
- However, these procedures can be implemented if the factory calibration of the desired range is not within specification.

CAUTION

FIELD CALIBRATION WILL BE LOST

The field calibration will be lost if a change in input type configuration is implemented at a later time. The original factory calibration data remains available for later use after a field calibration is done. See subsection 6.6 if you want to restore factory calibration.

What's in this section?

The following topics are covered in this section.

TOPIC	See Page
6.1 Overview	39
6.2 Minimum and Maximum Range Values	40
6.3 Preliminary Information	41
6.4 Input Set Up Wiring	43
6.5 Input Calibration Procedure	45
6.6 Restore Factory Calibration	47



WARNING—SHOCK HAZARD



INPUT CALIBRATION MAY REQUIRE ACCESS TO HAZARDOUS LIVE CIRCUITS, AND SHOULD ONLY BE PERFORMED BY QUALIFIED SERVICE PERSONNEL. MORE THAN ONE SWITCH MAY BE REQUIRED TO DE-ENERGIZE UNIT BEFORE CALIBRATION.

Failure to comply with these instructions could result in death or serious injury.

Calibration Steps

Use the following steps when calibrating an input.

Step	Action
1	Find the minimum and maximum range values for your PV input range from Table 6-1.
2	Disconnect the field wiring and find out what equipment you will need to calibrate.
3	Wire the calibrating device to your indicator according to the set up wiring instructions for your particular input (Subsection 6.4).
4	Follow the calibration procedure given for the Input (Subsection 6.5).

6.2 Minimum and Maximum Range Values

Select the Range Values

You should calibrate the indicator for the minimum (0 %) and maximum (100 %) range values of your particular indicator. Select the Voltage or Resistance equivalent for 0 % and 100 % range values from Table 6-1. Use these values when calibrating your indicator.

Table 6-1 Voltage and Resistance Equivalents for Input Range Values

Sensor Type	PV Input Range		Range Values	
	°F	°C	0 %	100 %
Thermocouples				
B	0 to 3300	-18 to 1816	-0.100 mV	13.769 mV
E	-454 to 1832	-270 to 1000	-9.835 mV	76.373 mV
E (low)	-200 to 1100	-129 to 593	-6.472 mV	44.455 mV
J	0 to 1600	-18 to 871	-0.886 mV	50.060 mV
J (low)	20 to 770	-7 to 410	-0.334 mV	22.400 mV
K	0 to 2400	-18 to 1816	-0.692 mV	52.952 mV
K (low)	-20 to 1000	-29 to 538	-1.114 mV	22.255 mV
NiNiMoly (NNM68)	32 to 2500	0 to 1371	0.000 mV	71.330 mV
NiNiMoly (low)	32 to 1260	0 to 682	0.000 mV	31.820 mV
NiMo-NiCo (NM90)	32 to 2500	0 to 1371	0.000 mV	71.773 mV
NiMo-NiCo (low)	32 to 1260	0 to 682	0.000 mV	31.825 mV
Nicrosil Nisil (Nic)	0 to 2372	-18 to 1300	-0.461 mV	47.513 mV
R	0 to 3100	-18 to 1704	-0.090 mV	20.281 mV
S	0 to 3100	-18 to 1704	-0.092 mV	17.998 mV
T	-300 to 700	-184 to 371	-5.341 mV	19.097 mV
T (low)	-200 to 500	-129 to 260	-4.149 mV	12.574 mV

Sensor Type	PV Input Range		Range Values	
	°F	°C	0 %	100 %
W5W26	0 to 4200	-18 to 2315	-0.234 mV	37.075 mV
W5W26 (low)	0 to 2240	-18 to 1227	-0.234 mV	22.283 mV
Honeywell Radamatic				
Type RH	0 to 3400	-18 to 1871	0.00 mV	57.12 mV
Type RI	0 to 3200	-18 to 1760	0.00 mV	60.08 mV
RTD (IEC Alpha=0.00385)				
100 ohms	-300 to 1200	-184 to 649	25.18 ohms	274.96 ohms
100 ohms (low)	-300 to 300	-184 to 149	25.18 ohms	156.90 ohms
200 ohms	-300 to 900	-184 to 482	50.36 ohms	549.92 ohms
500 ohms	-300 to 900	-184 to 482	125.90 ohms	1374.80 ohms
Linear				
Milliamps (impedance – 249 Ω)	4 to 20 mA 0 to 20 mA		4.00 mA 0.00 mA	20.00 mA 20.00 mA
Millivolts	0 to 10 mV 0 to 50 mV 0 to 100 mV		0.00 mV 0.00 mV 0.00 mV	10.00 mV 50.00 mV 100.00 mV
Volts	1 to 5 Volts 0 to 2 Volts 0 to 5 Volts 0 to 10 Volts		1.00 Volts 0.00 Volts 0.00 Volts 0.00 Volts	5.00 Volts 2.00 Volts 5.00 Volts 10.00 Volts

6.3 Preliminary Information

Disconnect the Field Wiring

Tag and disconnect any field wiring connected to the input terminals on the rear of the indicator.

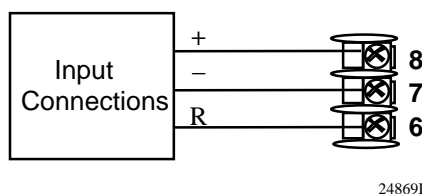

Figure 6-1 Input Wiring Terminals

Check the Jumper for Input

Before you calibrate the Input, check the internal jumper for the Input to make sure it is set for the correct input type. The jumper is located at position S101 on the printed wiring board. Figure 2-2 shows the location of the jumper and position selections.

Equipment Needed

Table 6-2 lists the equipment you will need to calibrate the specific types of inputs that are listed in the table. You will need a screwdriver to connect these devices to your indicator.

Table 6-2 Equipment Needed

Type of Input	Equipment Needed
Thermocouple Inputs (Ice Bath)	<ul style="list-style-type: none"> • A calibrating device with $\pm 0.02\%$ accuracy for use as a signal source such as a millivolt source. • Thermocouple extension wire that corresponds with the type of thermocouple that will be used with the indicator input. • Two insulated copper leads for connecting the thermocouple extension wire from the ice baths to the mV source. • Two containers of crushed ice.
Thermocouple Inputs (T/C Source)	<ul style="list-style-type: none"> • A calibrating device with $\pm 0.02\%$ accuracy for use as a signal source such as a millivolt source. • Thermocouple extension wire that corresponds with the type of thermocouple that will be used with indicator input.
RTD (Resistance Thermometer Device)	<ul style="list-style-type: none"> • A decade box, with $\pm 0.02\%$ accuracy, capable of providing stepped resistance values over a minimum range of 0 to 1400 ohms with a resolution of 0.1 ohm. • Three insulated copper leads of equal length for connecting the decade box to the indicator.
Milliampere, Millivolt, Volts, and Radiamatic	<ul style="list-style-type: none"> • A calibrating device with $\pm 0.02\%$ accuracy for use as a signal source. • Two insulated copper leads for connecting the calibrator to the indicator. • Place current source at zero before switching ON. • Do not switch current sources OFF/ON while connected to the UDC2300 input.

NOTICE

For Radiamatic inputs only, set Emissivity value to 1.0. See *Section 4.5 – Configuration Set Up* prompt INPUT1, function prompt EMISS.

6.4 Input Set Up Wiring

Thermocouple Inputs Using an Ice Bath

Refer to Figure 6-2 and wire the indicator according to the procedure given in Table 8-3. Make sure the jumper at S101 is in the #1 position (Figure 2-2).

Table 6-3 Set Up Wiring Procedure for Thermocouple Inputs Using an Ice Bath

Step	Action
1	Connect the copper leads to the calibrator.
2	Connect a length of thermocouple extension wire to the end of each copper lead and insert the junction points into the ice bath.
3	Connect the thermocouple extension wires to the terminals for Input #1. See Figure 6-2.

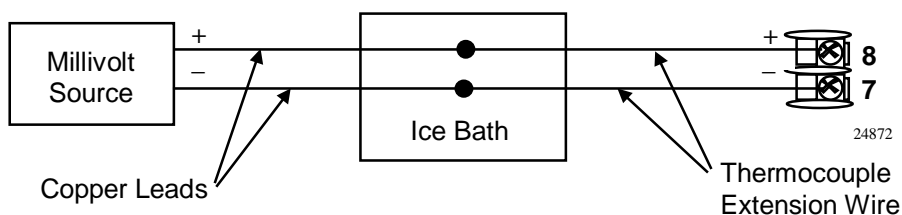

Figure 6-2 Wiring Connections for Thermocouple Inputs Using an Ice Bath

Thermocouple Inputs Using a Thermocouple Source

Refer to Figure 6-3 and wire the indicator according to the procedure given in Table 8-4. Make sure the jumper at S101 is in the #1 position (Figure 2-2).

Table 6-4 Set Up Wiring Procedure for Thermocouple Inputs using Thermocouple Source

Step	Action
1	Connect the thermocouple extension wires to the terminals for the Input as shown in Figure 6-3.

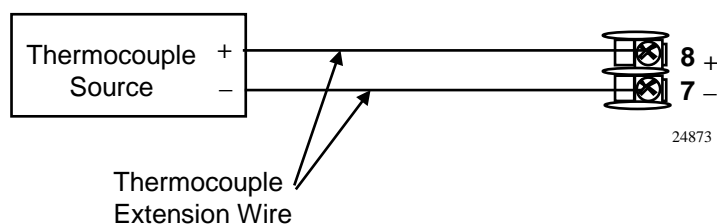

Figure 6-3 Wiring Connections for Thermocouple Inputs Using Thermocouple Source

RTD Inputs

Refer to Figure 6-4 and wire the indicator according to the procedure given in Table 6-5. Make sure the jumper at S101 is in the #2 position (Figure 2-2).

Table 6-5 Set Up Wiring Procedure for RTD Inputs

Step	Action
1	Connect the copper leads from the calibrator to the Input terminals as shown in Figure 6-4.
2	Place current source at zero before switching on.
3	Do not switch current sources ON/OFF while connected to the UDC2300 input.

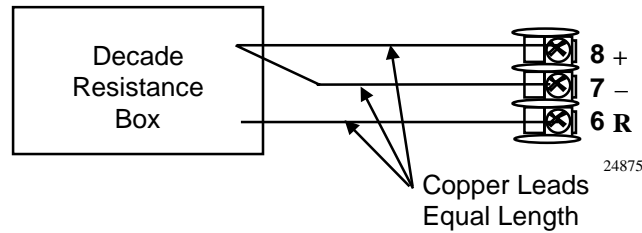

Figure 6-4 Wiring Connections for RTD (Resistance Thermometer Device)

Radiamatic, Millivolts, Milliampere, or Volts

Refer to Figure 6-5 and wire the indicator according to the procedure given in Table 6-6. Make sure the jumper at S101 is in the #2 position for, mV, Volts, or the #4 position for mA (Figure 2-2).

Table 6-6 Set Up Wiring Procedure for Radiamatic, Milliampere, Millivolts, or Volts Inputs (Except 0-10 Volts)

Step	Action
1	Connect the copper leads from the calibrator to the Input terminals as shown in Figure 6-5.
2	Place current source at zero before switching on.
3	Do not switch current sources ON/OFF while connected to the UDC2300 input.

NOTICE

For Radiamatic inputs only, set Emissivity value to 1.0. See *Section 4.5 – Configuration Set Up* prompt INPUT1, function prompt EMISS.

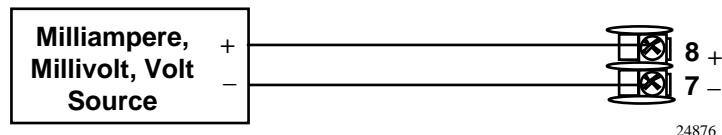

Figure 6-5 Wiring Connections for Radiamatic, Milliampere, Millivolts, or Volts (Except 0 to 10 Volts)

0 to 10 Volts

Refer to Figure 6-6 and wire the indicator according to the procedure given in Table 6-7. Make sure the jumper at S101 is in parked position (Figure 2-2).

Table 6-7 Set Up Wiring Procedure for 0 to 10 Volts

Step	Action
1	Connect the copper leads from the calibrator to the Input terminals as shown in Figure 6-6.
2	Place current source at zero before switching on.
3	Do not switch current sources ON/OFF while connected to the UDC2300 input.

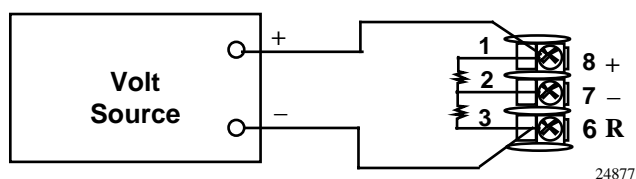

Figure 6-6 Wiring Connections for 0 to 10 Volts

6.5 Input Calibration Procedure

Preliminary Steps

- Apply power and allow the indicator to warm up for 30 minutes before you calibrate.
- Please read Subsection 6.4 “Input Set Up Wiring” before beginning the procedure.
- **Make sure you have LOCK set to NONE. See Section 4.4**

See Table 6-1 for Voltage vs. Resistance equivalents or 0 % and 100 % range values.

CAUTION

For linear inputs, avoid step changes in inputs. Vary smoothly from initial value to final 100 % value.

Procedure

The calibration procedure for the Input is listed in Table 6-8.

Table 6-8 Input Calibration Procedure

Step	Operation	Press	Result				
1	Enter Calibration Mode	<div style="border: 1px solid black; padding: 2px; display: inline-block;">SET UP</div> until you see <div style="border: 1px solid black; padding: 2px; display: inline-block;">FUNCTION</div>	Upper Display = CAL (- - - -) Lower Display = INPUT1 (10000) You will see: Upper Display = DIS (0) Lower Display = CALIN1 (10001) <div style="border: 1px solid black; padding: 2px; display: inline-block; width: 20px; text-align: center;">▲</div> The calibration sequence is enabled and you will see: Upper Display = BEGN (1) Lower Display = CALIN1 (10001) At the completion of the sequence, the selection automatically reverts to disable.				
2	Calibrate 0 %	<div style="border: 1px solid black; padding: 2px; display: inline-block;">FUNCTION</div>	You will see: Upper Display = APLY (2) Lower Display = IN1ZRO (10002) <ul style="list-style-type: none"> • Adjust your calibration device to an output signal equal to the 0 % range value for your particular input sensor. See Table 6-1 for Voltage, Degrees, or Resistance equivalents for 0 % range values. • Wait 15 seconds, then go to the next step. 				
3	Calibrate 100 %	<div style="border: 1px solid black; padding: 2px; display: inline-block;">FUNCTION</div>	You will see: Upper Display = APLY (2) Lower Display = IN1SPN (10003) <ul style="list-style-type: none"> • Adjust your calibration device to an output signal equal to the 100 % range value for your particular input sensor. See Table 6-1 for Voltage, Degrees, or Resistance equivalents for 100 % range values. • Wait 15 seconds, and <table border="1" style="width: 100%; border-collapse: collapse;"> <tr> <td style="width: 50%; padding: 5px;"> If ... you are calibrating a Thermocouple input </td> <td style="width: 50%; padding: 5px;"> Then ... go to step 4 </td> </tr> <tr> <td style="padding: 5px;"> you are calibrating other than a Thermocouple input </td> <td style="padding: 5px;"> go to step 5 </td> </tr> </table>	If ... you are calibrating a Thermocouple input	Then ... go to step 4	you are calibrating other than a Thermocouple input	go to step 5
If ... you are calibrating a Thermocouple input	Then ... go to step 4						
you are calibrating other than a Thermocouple input	go to step 5						

Step	Operation	Press	Result
4	Check the Cold Junction Temperature	FUNCTION	<p>The calculations for zero and span are now stored and you will see:</p> <p><i>Upper Display</i> = The cold junction temperature at the rear terminals <i>Lower Display</i> = CJTEMP (10004)</p> <p>The value in the upper display is in tenths of a degree. It is the current reading of the temperature as measured at the thermocouple terminals and recognized by the indicator. You can change this value, if it is in error, using the [▲] [▼] keys.</p> <div style="border: 1px solid black; padding: 5px; margin-top: 10px;"> <p>NOTICE</p> <p>The accuracy of the controller is directly affected by the accuracy of this value. Change this value only if the zero and span calibration procedures did not bring the indicator within the specified accuracy requirements.</p> </div>
5	Exit the Calibration Mode	FUNCTION then DISPLAY	The indicator stores the calibration constants and exits the calibration mode.

6.6 Restore Factory Calibration

Introduction

The factory calibration constants for all the input actuation types that can be used with the indicator are stored in its nonvolatile memory. Thus, you can quickly restore the “Factory Calibration” for a given input actuation type by simply changing the actuation type to another type and then changing it back to the original type.

Refer to Table 6-9 Restore Factory Calibration for procedure.

NOTICE

A restored factory calibration overwrites any previous field calibration done for the input and may change the High and Low Range Limits. Be sure to protect any field calibration from accidental overwrites by configuring the appropriate LOCKOUT selection after calibration. See *Section 4 - Configuration* for specific instructions to set the lockout.

Table 6-9 Restore Factory Calibration

Step	Operation	Press	Result
1	Set LOCKOUT to NONE	SET UP	until you see: <i>Upper Display</i> = SET UP <i>Lower Display</i> = LOCK
		FUNCTION	Until you see: <i>Upper Display</i> = one of the following: NONE – all parameters are read/write CAL - all parameters are read/write except Calibration CONF – configuration parameters are Read Only; no writes permitted ALL – Only the Lockout group is available for read/write. No other parameters are viewable. <i>Lower Display</i> = LOCK
		[▲] [▼]	Until NONE is in the upper display
2	Enter INPUT 1 Setup Group	SET UP	until you see: <i>Upper Display</i> = SET UP <i>Lower Display</i> = INPUT 1
		FUNCTION	until you see: <i>Upper Display</i> = the current selection <i>Lower Display</i> = INxTYP
		[▲] [▼]	to change the current selection to another selection
3	Scroll through Functions	FUNCTION	until the lower display rolls through the rest of the functions and returns to: <i>Upper Display</i> = the new selection <i>Lower Display</i> = INxTYP
		[▲] [▼]	until you change the input selection in the upper display back to the proper selection. You will see: <i>Upper Display</i> = Original Input Selection that matches your type of sensor. <i>Lower Display</i> = INxTYP
4	Return to Normal Operation	DISPLAY	to return to Normal operating mode. The factory calibration will be restored. If the problem is not corrected, contact the Honeywell Technical Assistance Center. 1-800-423-9883 USA and Canada

7 Troubleshooting/Service

7.1 Overview

Introduction

Instrument performance can be adversely affected by installation and application problems as well as by hardware problems. We recommend that you investigate the problems in the following order:

- installation related problems
- application related problems
- hardware and software related problems

and use the information presented in this section to solve them.

What's in this section?

The following topics are covered in this section.

TOPIC		See Page
7.1	Overview	49
7.2	Troubleshooting Aids <ul style="list-style-type: none"> • Overall Error Messages • Indicator Failure Symptoms • Customer Support • Determining the Software Version Number 	51
7.3	Power-up Tests	53
7.4	Status Tests	53
7.5	Background Tests	54
7.6	Indicator Failure Symptoms	55
7.7	Troubleshooting Procedures <ul style="list-style-type: none"> • Power Failure • Alarm Relay Output Failure • Keyboard Failure 	56

Installation related problems

Read the Installation section in this manual to make sure the UDC2300 has been properly installed. The installation section provides information on protection against electrical noise, connecting external equipment to the indicator, and shielding and routing external wiring.

NOTICE

System noise induced into the indicator will result in diagnostic error messages recurring. If the diagnostic error messages can be cleared, it indicates a “soft” failure and is probably noise related.

If system noise is suspected, completely isolate the controller from all field wiring. Use calibration sources to simulate PV and check all controller functions; i.e. Gain, Rate, Reset, Output, Alarms, etc.

Application related problems

Review the application of the indicator; then, if necessary, direct your questions to the local sales office.

Hardware and software related problems

Use the troubleshooting error message prompts and indicator failure symptoms to identify typical failures which may occur in the indicator.

Follow the troubleshooting procedures to correct them.

7.2 Troubleshooting Aids

Overall error messages

An error message can occur

- at power-up, see Subsection 7.3
- when the Status Tests are requested, see Subsection 7.4
- during continuous background tests while in normal operation, see Subsection 7.5

Indicator failure symptoms

Other failures may occur that deal with the Power or Alarms.

Refer to the indicator failure symptoms in Table 7-4 to determine what is wrong and the troubleshooting procedures to use to correct the problem.

Check installation

If a set of symptoms still persists, refer to *Section 2 - Installation* and ensure proper installation and proper use of the indicator in the system.

Customer support

If you cannot solve the problem using the troubleshooting procedures listed in this section, you can get **technical assistance** by dialing 1-800-423-9883 USA and Canada.

An engineer will discuss your problem with you. **Please have your complete model number, serial number, and Software version available.** The model and serial numbers can be found on the chassis nameplate. The software version can be viewed under Setup Group "Status." See Table 7-1.

If it is determined that a hardware problem exists, a replacement indicator or part will be shipped with instructions for returning the defective unit.

Do not return your indicator without authorization from Honeywell's Technical Assistance Center or until the replacement has been received.

For a list of frequently asked questions and their answers, dial Honeywell's **Faxback** 24 hour Service:

1-888-423-9883 USA

Or check out Honeywell's **web site** at: <http://www.honeywell.com/sensing>

Determining the software version

Table 7-1 lists the procedure for identifying the software version number.

Table 7-1 Procedure for Identifying the Software Version

Step	Operation	Press	Result
1	Select STATUS Set Up Group	SET UP	<i>Upper Display</i> = READ <i>Lower Display</i> = STATUS
2	Read the software version	FUNCTION	You will see: <i>Upper Display</i> = Software version number <i>Lower Display</i> = A1xx Basic Controller and Indicator A2xx Limit Controller

Please give this number to the Customer Support person. It will indicate which version of UDC2300 you have and help them determine a solution to your problem.

7.3 Power-up Tests

What happens at power-up

When power is applied, the indicator will run three diagnostic tests. After these tests are completed, “TEST DONE” is displayed.

Test Failures

If one or more of these tests fail, the indicator will go to the Failsafe Manual Mode, and FAILSF will flash in the lower display and a message indicating which test failed will appear in the lower display. Then, “DONE” will appear in the lower display.

7.4 Status Tests

Introduction

When required, the results of these tests can be checked to determine the reason the indicator has gone to Failsafe.

How to check the status tests

The procedure in Table 7-2 tells you how to display the results of the status tests.

Table 7-2 Procedure for Displaying the Status Test Results

Step	Operation	Press	Result
1	Select STATUS Set Up Group	SET UP	Upper Display = READ Lower Display = STATUS
2	Read the test results	FUNCTION	You will see: Upper Display = NO or YES YES indicates a failure Lower Display = FAILSF
		FUNCTION	Upper Display = PASS or FAIL Lower Display = TEST

7.5 Background Tests

Introduction

The UDC2300 performs ongoing background tests to verify data and memory integrity. If there is a malfunction, an error message will be displayed (blinking) in the lower display.

In the case of simultaneously malfunctions, the messages will appear in sequence in the lower display. Table 7-3 lists these background tests, the reason for their failure, and how to correct the problem.

Table 7-3 Background Tests

Lower Display	Reason for Failure	How to Correct the Problem
EE FAIL	Unable to write to non-volatile memory. Anytime you change a parameter and it is not accepted, you will see EE FAIL.	<ol style="list-style-type: none"> 1. Check the accuracy of the parameter and re-enter. 2. Try to change something in configuration. 3. Run through STATUS tests to re-write to EEPROM.
FAILSF	<p>This error message shows whenever the indicator goes into a failsafe mode of operation. This will happen if:</p> <ul style="list-style-type: none"> • RAM test failed • Configuration test failed • Calibration test failed • Burnout configured for none and the input failed. 	<ol style="list-style-type: none"> 1. Run through STATUS check to determine the reason for the failure. 2. Press the [SET UP] key until STATUS appears in the lower display. 3. Press the [FUNCTION] key to see whether the tests pass or fail, then run through the STATUS codes a second time to see if the error cleared.
IN1FL	<p>Two consecutive failures of input 1 integration; i.e., cannot make analog to digital conversion. This will happen if:</p> <ul style="list-style-type: none"> • Upscale or Downscale burnout is selected • Input not configured correctly 	<ol style="list-style-type: none"> 1. Make sure the actuation is configured correctly. See <i>Section 4 - Configuration</i>. 2. Make sure the input is correct. 3. Check for gross over-ranging. Check S101 jumper position (Figure 2-2). 4. Restore factory calibration. See <i>Section 6.6</i>
IN1RNG	Input 1 out of range. The process input is outside the range limits.	<ol style="list-style-type: none"> 1. Make sure the range and actuation are configured properly. 2. Check the input source. 3. Restore the factory calibration. (See <i>Section 6.6</i>.) 4. Field calibrate. See <i>Section 6 - Input Calibration</i>.
PV LIM	<p>PV out of range. $PV = INP1 \times RATIO1 + INP1 \text{ BIAS}$</p>	<ol style="list-style-type: none"> 1. Make sure the input signal is correct. 2. Make sure the Ratio and Bias settings are correct. 3. Recheck the calibration. Use Bias of 0.0

7.6 Indicator Failure Symptoms

Introduction

In addition to the error message prompts, there are failure symptoms that can be identified by noting how the indicator displays and indicators are reacting.

Symptoms

Compare your symptoms with those shown in Table 7-4.

Table 7-4 Indicator Failure Symptoms

Upper Display	Lower Display	Indicators	Indicator Output	Probable Cause	Trouble-shooting Procedure
Blank	Blank	Off	None	Power Failure	1
OK	OK	OK	External Alarm function does not operate properly	Malfunction in alarm output	2
Display does not function when a key is pressed				Keyboard Malfunction	3

Other symptoms



If a set of symptoms or prompts other than the one you started with appears while troubleshooting, re-evaluate the symptoms. This may lead to a different troubleshooting procedure.

If the symptom still persists, refer to the installation section in this manual to ensure proper installation and proper use of the indicator in your system.

7.7 Troubleshooting Procedures

Introduction

The troubleshooting procedures are listed in numerical order as they appear in Table 7-4. Each procedure lists what to do if you have that particular failure and how to do it or where to find the data needed to accomplish the task.

WARNING—SHOCK HAZARD

TROUBLESHOOTING MAY REQUIRE ACCESS TO HAZARDOUS LIVE CIRCUITS, AND SHOULD ONLY BE PERFORMED BY QUALIFIED SERVICE PERSONNEL. MORE THAN ONE SWITCH MAY BE REQUIRED TO DE-ENERGIZE UNIT BEFORE SERVICING.

Failure to comply with these instructions could result in death or serious injury.

Equipment needed

You will need the following equipment in order to troubleshoot the symptoms listed in the tables that follow:

- DC Milliammeter – mA_{dc}
- Calibration sources – T/C, mV, Volt, etc.
- Voltmeter

Procedure #1

Table 7-5 explains how to troubleshoot power failure symptoms.

Table 7-5 Troubleshooting Power Failure Symptoms

Step	What to do	How to do it
1	Check the AC line voltage.	Use a voltmeter to measure the AC voltage across terminals L1 and L2 on the rear terminal panel of the indicator. Check the earth ground connection.
2	Make sure the chassis plugs into the rear of the case properly.	Withdraw the chassis and visually inspect the indicator board and the inside of the case.
3	Check the system for Brown-outs, heavy load switching, etc., and conformance to installation instructions.	Refer to <i>Section 2 - Installation</i> .
4	Change Main board.	Installation instructions supplied with new board.

Procedure #2

Table 7-6 explains how to troubleshoot Alarm Relay Output failure.

Table 7-6 Troubleshooting Alarm Relay Output Failure

Step	What to do	How to do it
1	Check the alarm configuration data. If it is correct, check the field wiring.	Reconfigure if necessary. Refer to <i>Section 4 - Configuration</i> for details.
2	Check that the applicable alarm relay actuates properly depending on what you have set at prompt AxSxTYPE. If it does, check the field wiring.	If the alarm type is set for PV vary the input to raise and lower the PV around the alarm setpoint. Listen for a click from the relay as the PV moves in either direction and note that the proper ALM1 or ALM2 is lit.
3	Check the contacts.	Make sure the NO or NC contact wiring is correct. Refer to <i>Section 2 - Installation</i> for relay jumper placement and relay contact information.
4	Change Main board.	Installation instructions supplied with new board.

Procedure #3

Table 7-7 explains how to troubleshoot a Keyboard failure.

Table 7-7 Troubleshooting a Keyboard Failure

Step	What to do	How to do it
1	Make sure the keyboard is connected properly.	Withdraw the chassis from the case and visually inspect the connection.
2	Indicator Keyboard or specific keys may be LOCKED OUT via the security code.	Use your four-digit security code number to change the lockout level. Refer to <i>Section 4 – Configuration</i> .
<p>NOTICE</p> <p>Using “1000” as a security code number will override the 4-digit code previously entered.</p>		
3	Replace the display/keyboard if any keys are not functioning.	Installation instructions supplied with new display/keyboard.

8 Parts List

8.1 Exploded View

Introduction

Figure 8-1 is an exploded view of the UDC2300 Indicator. Each part is labeled with a key number. The part numbers are listed by key number in Table 8-1. Parts not shown are listed in Table 8-2.

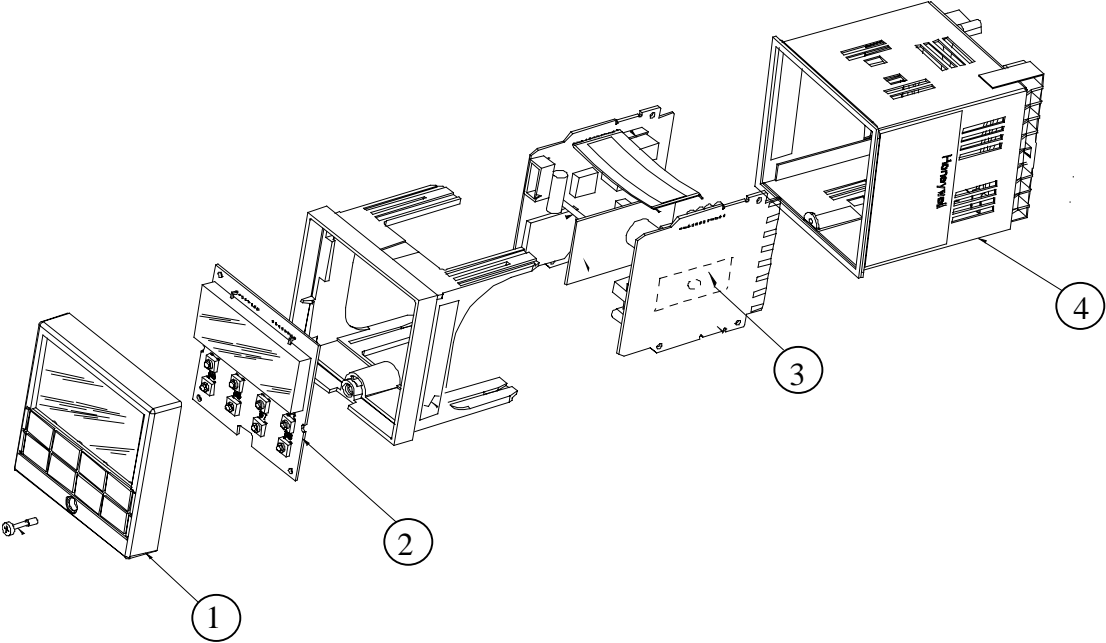

Figure 8-1 UDC2300 Exploded View

Table 8-1 Parts Identification

Key Number	Part Number	Description
1	30756667-503	Bezel Assembly (Gray)
2	51309766-501	Display/Keyboard
3	51309831-501	RS-422/485 Communications PWA
4	51404896-501	Case Assembly (includes 30755050-001 Mounting Kit)

Table 8-2 Parts Not Shown

Part Number	Description
30755223-003	DIN Adaptor (Gray)
30756683-001	NEMA 3 Gasket (Panel to Case)
30755050-001	Mounting Kit
30757215-001	NEMA 4 Adaptor Kit
30756764-002	Rear Terminal Cover Kit
30756018-001	SS Relay 10 Amp (external)
30756725-501	SS Relay 1 Amp (internal)
30754465-501	0-10 Volt Input resistor assembly (100K pair)
30754142-003	Terminal Strip Assembly
30755306-501	Electro-mechanical Relay (5 Amp)

9 Index

A

Accuracy, 4
 Alarm Blocking, 31
 Alarm Circuit Wiring, 11
 Alarm Hysteresis, 31
 Alarm Relay Action., 6
 Alarm Relay Output failure, 57
 Alarm relays, 8
 Alarm Setpoints, 37
 Alarm Setpoints Display, 37
 Alarms Set Up Group, 30
 Alarmx Setpoint x State, 30
 Alarmx Setpointx Type, 30
 Alarmx Setpointx Value, 30
 Ambient Temperature, 4
 Annunciators, 36
 Application related problems, 50

B

background tests, 54
 Baud Rate, 27
 Bias on Input 1, 25
 Burnout Protection, 25

C

Calibration Mode, 48
 calibration procedure, 46
 Calibration Steps, 40
 CE Conformity, 4
 CE Conformity (Europe), 2
 Cold Junction Temperature, 47
 Communi-cations Override Units, 28
 Communications State, 27
 Composite Wiring Diagram, 12
 Configuration, 19
 Configuration Lockout, 22
 Configuration Procedure, 21
 Configuration Prompt Hierarchy, 20
 Configuration Record Sheet, 32
 Control and Alarm Relay Contact Information, 8
 Controller Grounding, 11
 Customer support, 51

D

Decimal Point Selection, 23
 Dimensions, 9
 DOWNSCALE BURNOUT, 25

E

Electrical Considerations, 11
 Electrical Noise Precautions, 11
 Emissivity, 26
 EMISSIVITY, 26
 equipment you will need to calibrate, 42
 Error Messages, 36
 Exploded View, 59
 External Interface Option Connections, 15
External Wiring, 11

F, G, H

Factory calibration, 47
 FAILSAFE, 25
 Failsafe Manual Mode, 17, 53
 Field Wiring, 41
 Filter for Input 1, 25
 Function Prompts, 20

I

Indicator Failure Symptoms, 55
 Initial Start-up, 17
 Input 1 Actuation Type, 23, 24
 Input 1 High Range Value, 24
 Input 1 Low Range Value, 24
 Input 1 Set Up Group, 23
 Input Calibration, 39
 Input Calibration Procedure, 45
 Input Connections, 13
 Input I Jumper Placement, 6
 Input Set Up Wiring, 43
 Input Wiring Terminals, 41
 Installation, 3
 Installation related problems, 50

J

Jumper for Input, 41
 Jumper Placement, 7

K

Key error, 35
 Key Error Message, 18
 Key Functions, 18
 Keyboard failure, 58

L

Language Selection, 26
Latching Alarm Output, 31
Local Loopback Test, 29
Lock Set Up Group, 22
lockout feature, 35
Lockout levels, 35

M, N

Mains Power Supply, 11, 13
Mechanical Shock, 4
Minimum and Maximum Range Values, 40
Model Number Interpretation, 5
Monitoring t, 33
Mounting, 9
Mounting Method, 10
Mounting Procedure, 10

O

Open Collector Alarm Relay Output, 14
Operating Limits, 4
Operator Interface, 1, 18, 34

P, Q

Parity, 27
Parts Identification, 59
Parts List, 59
Permissible Wiring Bundling, 12
Physical Considerations, 9
Power, 4
Power Consumption, 4
power failure symptoms, 57
Power Line Frequency, 26
Powering Up, 17
Power-up Tests, 53
Pre-installation Information, 4
Preliminary Checks, 6

R

Ratio on Input, 24
Relative Humidity, 4
Response Delay, 28
Restore Factory Calibration, 47
RTD Inputs, 44

S

SECURITY CODE, 22, 34
Sensor Break, 25
Set Up Group, 20
Set Up groups, 19
Shed Enable, 27
Shed Time, 27
Shock hazard warning, 56
software version number, 52
Specifications, 4
start up, 17
Station Address, 27
Status Tests, 53
Suppression Devices, 11

T

Temperature Units, 23
Test Failures, 17, 53
Thermocouple Inputs Using a Thermocouple Source, 43
Thermocouple Inputs Using an Ice Bath, 43
Transmitter Character-ization, 24
Troubleshooting Aids, 51
troubleshooting procedures, 56
Troubleshooting/Service, 49

U

UPSCALE BURNOUT, 25

V

Vibration, 4
Voltage and Resistance Equivalents for 0% and 100% Range Values, 40

W, X, Y, Z

WARNING—SHOCK HAZARD, 56
Wiring, 11
Wiring Bundling, 12
Wiring Connections for Radiamatic, Milliampere, Millivolts, or Volts (Except 0 to 10 Volts), 45
Wiring Connections for RTD (Resistance Thermometer Device), 44
Wiring Diagrams, 12
Wiring the Indicator, 12

HONEYWELL SERVICE CENTERS

ARGENTINA

HONEYWELL S.A.I.C.
BELGRANO 1156
BUENOS AIRES
ARGENTINA
Tel. : 54 1 383 9290

BULGARIA

HONEYWELL EOOD
14, Iskarsko Chausse
POB 79
BG- 1592 Sofia
BULGARIA
Tel : 359-791512/ 794027/ 792198

GERMANY

HONEYWELL AG
Kaiserleistrasse 39
D-63067 OFFENBACH
GERMANY
Tel. : 49 69 80 640

ASIA PACIFIC

HONEYWELL ASIA PACIFIC Inc.
Room 3213-3225
Sun Kung Kai Centre
N° 30 Harbour Road
WANCHAI
HONG KONG
Tel. : 852 829 82 98

CANADA

HONEYWELL LIMITED
THE HONEYWELL CENTRE
529 Mc Nicoll Avenue
M2H 2C9 NORTH YORK,
ONTARIO
CANADA
Tel. : 416 502 5200

HUNGARY

HONEYWELL Kft
Gogol u 13
H-1133 BUDAPEST
HUNGARY
Tel. : 36 1 451 43 00

AUSTRALIA

HONEYWELL LIMITED
5 Thomas Holt Drive
North Ryde Sydney
NSW AUSTRALIA 2113
Tel. : 61 2 353 7000

CZECH REPUBLIC

HONEYWELL, Spol.s.r.o.
Budejovicka 1
140 21 Prague 4
Czech Republic
Tel. : 42 2 6112 3434

ICELAND

HONEYWELL
Hataekni .hf
Armuli 26
PO Box 8336
128 reykjavik
Iceland
Tel : 354 588 5000

AUSTRIA

HONEYWELL AUSTRIA G.m.b.H.
Handelskai 388
A1020 VIENNA
AUSTRIA
Tel. : 43 1 727 800

DENMARK

HONEYWELL A/S
Automatikvej 1
DK 2860 Soeborg
DENMARK
Tel. : 45 39 55 56 58

ITALY

HONEYWELL S.p.A.
Via P. Gobetti, 2/b
20063 Cernusco Sul Naviglio
ITALY
Tel. : 39 02 92146 1

BELGIUM

HONEYWELL S.A.
3 Avenue de Bourget
B-1140 BRUSSELS
BELGIUM
Tel. : 32 2 728 27 11

FINLAND

HONEYWELL OY
Ruukintie 8
FIN-02320 ESPOO 32
FINLAND
Tel. : 358 0 3480101

MEXICO

HONEYWELL S.A. DE CV
AV. CONSTITUYENTES 900
COL. LOMAS ALTAS
11950 MEXICO CITY
MEXICO
Tel : 52 5 259 1966

BRAZIL

HONEYWELL DO BRAZIL AND CIA
Rua Jose Alves Da Chunha
Lima 172
BUTANTA
05360.050 SAO PAULO SP
BRAZIL
Tel. : 55 11 819 3755

FRANCE

HONEYWELL S.A.
Bâtiment « le Mercury »
Parc Technologique de St Aubin
Route de l'Orme (CD 128)
91190 SAINT-AUBIN
FRANCE
Tel. from France: 01 60 19 80 00
From other countries: 33 1 60 19 80 00

THE NETHERLANDS

HONEYWELL BV
Laaderhoogtweg 18
1101 EA AMSTERDAM ZO
THE NETHERLANDS
Tel : 31 20 56 56 911

HONEYWELL SERVICE CENTERS

NORWAY

HONEYWELL A/S
Askerveien 61
PO Box 263
N-1371 ASKER
NORWAY
Tel. : 47 66 76 20 00

POLAND

HONEYWELL Sp.z.o.o
Ul Domainewska 41
02-672 WARSAW
POLAND
Tel. : 48 22 606 09 00

PORTUGAL

HONEYWELL PORTUGAL LDA
Edificio Suecia II
Av. do Forte nr 3 - Piso 3
2795 CARNAXIDE
PORTUGAL
Tel. : 351 1 424 50 00

REPUBLIC OF IRELAND

HONEYWELL
Unit 1
Robinhood Business Park
Robinhood Road
DUBLIN 22
Republic of Ireland
Tel. : 353 1 4565944

REP. OF SINGAPORE

HONEYWELL PTE LTD
BLOCK 750E CHAI CHEE ROAD
06-01 CHAI CHEE IND. PARK
1646 SINGAPORE
REP. OF SINGAPORE
Tel. : 65 2490 100

REPUBLIC OF SOUTH AFRICA

HONEYWELL
Southern Africa
PO BOX 138
Milnerton 7435
REPUBLIC OF SOUTH AFRICA
Tel. : 27 11 805 12 01

ROMANIA

HONEYWELL Office
Bucharest
147 Aurel Vlaicu Str., Sc.Z.,
Apt 61/62
R-72921 Bucharest
ROMANIA
Tel : 40-1 211 00 76/ 211 79 43

RUSSIA

HONEYWELL INC
4th Floor Administrative
Building of AO "Luzhniki"
Management
24 Luzhniki
119048 Moscow
RUSSIA
Tel : 7 095 796 98 00/01

SLOVAKIA

HONEYWELL Ltd
Mlynske nivy 73
PO Box 75
820 07 BRATISLAVA 27
SLOVAKIA
Tel. : 421 7 52 47 400/425

SPAIN

HONEYWELL S.A
Factory
Josefa Valcarcel, 24
28027 MADRID
SPAIN
Tel. : 34 91 31 3 61 00

SWEDEN

HONEYWELL A.B.
S-127 86 Skarholmen
STOCKHOLM
SWEDEN
Tel. : 46 8 775 55 00

SWITZERLAND

HONEYWELL A.G.
Hertistrasse 2
8304 WALLISELLEN
SWITZERLAND
Tel. : 41 1 831 02 71

TURKEY

HONEYWELL Otomasyon ve
Kontrol
Sistemler San ve Tic A.S.
(Honeywell Turkey A.S.)
Emirhan Cad No 144
Barbaros Plaza C. Blok Kat 18
Dikilitas 80700 Istanbul
TURKEY
Tel : 90-212 258 18 30

UNITED KINGDOM

HONEYWELL
Unit 1,2 &4 Zodiac House
Calleva Park
Aldermaston
Berkshire RG7 8HW
UNITED KINGDOM
Tel : 44 11 89 81 95 11

U.S.A.

HONEYWELL INC.
INDUSTRIAL CONTROLS DIV.
1100 VIRGINIA DRIVE
PA 19034-3260 FT. WASHINGTON
U.S.A.
Tel. : 215 641 3000

VENEZUELA

HONEYWELL CA
APARTADO 61314
1060 CARACAS
VENEZUELA
Tel. : 58 2 239 0211

Honeywell

Sensing and Control
Honeywell
11 West Spring Street
Freeport, IL 61032