

**UDC 2300**  
**Universal Digital Controller**  
**Product Manual**

**51-52-25-73C**

**4/00**

# Notices and Trademarks

Copyright 2000 by Honeywell  
Release C April, 2000

## Warranty/Remedy

Honeywell warrants goods of its manufacture as being free of defective materials and faulty workmanship. Contact your local sales office for warranty information. If warranted goods are returned to Honeywell during the period of coverage, Honeywell will repair or replace without charge those items it finds defective. The foregoing is Buyer's sole remedy and is **in lieu of all other warranties, expressed or implied, including those of merchantability and fitness for a particular purpose.** Specifications may change without notice. The information we supply is believed to be accurate and reliable as of this printing. However, we assume no responsibility for its use.

While we provide application assistance personally, through our literature and the Honeywell web site, it is up to the customer to determine the suitability of the product in the application.

**Sensing and Control**  
Honeywell  
11 West Spring Street  
Freeport, IL 61032

UDC 2300 is a U.S. registered trademark of Honeywell

Other brand or product names are trademarks of their respective owners.

---

# About This Document

## Abstract

This document provides descriptions and procedures for the Installation, Configuration, Operation, and Troubleshooting of your UDC 2300 Controller.

## Contacts

### World Wide Web

The following lists Honeywell's World Wide Web sites that will be of interest to our customers.

Honeywell Organization	WWW Address (URL)
Corporate	<a href="http://www.honeywell.com">http://www.honeywell.com</a>
Sensing and Control	<a href="http://www.honeywell.com/sensing">http://www.honeywell.com/sensing</a>
International	<a href="http://www.honeywell.com/Business/global.asp">http://www.honeywell.com/Business/global.asp</a>

### Telephone







Contact us by telephone at the numbers listed below.

	Organization	Phone Number
United States and Canada	Honeywell	1-800-423-9883 Tech. Support 1-888-423-9883 Q&A Faxback (TACFACS) 1-800-525-7439 Service
Asia Pacific	Honeywell Asia Pacific Hong Kong	(852) 2829-8298
Europe	Honeywell PACE, Brussels, Belgium	[32-2] 728-2111
Latin America	Honeywell, Sunrise, Florida U.S.A.	(954) 845-2600

---

## Symbol Definitions

The following table lists those symbols used in this document to denote certain conditions.

Symbol	Definition
	This CAUTION symbol on the equipment refers the user to the Product Manual for additional information. This symbol appears next to required information in the manual.
	<b>WARNING</b> <b>PERSONAL INJURY:</b> Risk of electrical shock. This symbol warns the user of a potential shock hazard where HAZARDOUS LIVE voltages greater than 30 Vrms, 42.4 Vpeak, or 60 VDC may be accessible. <b>Failure to comply with these instructions could result in death or serious injury.</b>
	ATTENTION, Electrostatic Discharge (ESD) hazards. Observe precautions for handling electrostatic sensitive devices
	Protective Earth (PE) terminal. Provided for connection of the protective earth (green or green/yellow) supply system conductor.
	Functional earth terminal. Used for non-safety purposes such as noise immunity improvement. NOTE: This connection shall be bonded to protective earth at the source of supply in accordance with national local electrical code requirements.
	Earth Ground. Functional earth connection. NOTE: This connection shall be bonded to Protective earth at the source of supply in accordance with national and local electrical code requirements.
	Chassis Ground. Identifies a connection to the chassis or frame of the equipment shall be bonded to Protective Earth at the source of supply in accordance with national and local electrical code requirements.

---

# Contents

<b>1</b>	<b>INTRODUCTION .....</b>	<b>1</b>
1.1	Overview .....	1
1.2	CE Conformity (Europe) .....	2
<b>2</b>	<b>INSTALLATION.....</b>	<b>3</b>
2.1	Overview .....	3
2.2	Model Number Interpretation.....	5
2.3	Preliminary Checks .....	6
2.4	Control and Alarm Relay Contact Information .....	8
2.5	Mounting .....	9
2.6	Wiring.....	11
2.7	Wiring Diagrams .....	12
<b>3</b>	<b>INITIAL START-UP .....</b>	<b>21</b>
3.1	Overview .....	21
3.2	Powering Up the Controller .....	21
3.3	Operator Interface and Key Functions .....	22
3.4	Key Error Message.....	22
<b>4</b>	<b>CONFIGURATION .....</b>	<b>23</b>
4.1	Overview .....	23
4.2	Configuration Prompt Hierarchy.....	24
4.3	Configuration Procedure .....	25
4.4	Timer Set Up Group.....	26
4.5	Tuning Set Up Group.....	27
4.6	SP Ramp Set Up Group.....	29
4.7	Accutune Set Up Group .....	31
4.8	Algorithm Set Up Group .....	32
4.9	Input 1 Set Up Group .....	33
4.10	Input 2 Set Up Group .....	35
4.11	Control Set Up Group.....	36
4.12	Options Set Up Group .....	38
4.13	Communications Set Up Group.....	39
4.14	Alarms Set Up Group.....	41
4.15	Configuration Record Sheet .....	43

---

<b>5</b>	<b>MONITORING THE CONTROLLER .....</b>	<b>45</b>
5.1	Overview .....	45
5.2	Operator Interface.....	46
5.3	Entering a Security Code.....	46
5.4	Lockout Feature.....	47
5.5	Monitoring Your Controller .....	49
<b>6</b>	<b>OPERATION .....</b>	<b>53</b>
6.1	Overview .....	53
6.2	Single Display Functionality .....	54
6.3	Start Up Procedure for Operation.....	56
6.4	Control Modes.....	57
6.4.1	Mode Definitions .....	57
6.4.2	What happens when you change modes.....	58
6.5	Setpoints .....	58
6.6	Timer .....	59
6.7	Accutune II .....	61
6.8	Fuzzy Overshoot Suppression .....	64
6.9	Using Two Sets of Tuning Constants.....	64
6.10	Alarm Setpoints .....	66
6.11	Three Position Step Control Algorithm .....	67
6.12	Setting a Failsafe Output Value for Restart After a Power Loss .....	68
6.13	Setting Failsafe Mode.....	69
<b>7</b>	<b>SETPOINT RATE/RAMP/PROGRAM OPERATION .....</b>	<b>71</b>
7.1	Overview .....	71
7.2	Setpoint Rate .....	72
7.3	Setpoint Ramp .....	72
7.4	Setpoint Ramp/Soak Programming .....	74
<b>8</b>	<b>INPUT CALIBRATION .....</b>	<b>83</b>
8.1	Overview .....	83
8.2	Minimum and Maximum Range Values .....	84
8.3	Preliminary Information .....	85
8.4	Input 1 Set Up Wiring .....	87
8.5	Input 1 Calibration Procedure .....	89
8.6	Input 2 Set Up Wiring .....	91
8.7	Input 2 Calibration Procedure .....	92
8.8	Restore Factory Calibration .....	93

<b>9</b>	<b>OUTPUT CALIBRATION .....</b>	<b>95</b>
9.1	Overview .....	95
9.2	Current Proportional Output Calibration .....	96
9.3	Auxiliary Output Calibration .....	98
9.4	Three Position Step Output Calibration .....	100
<b>10</b>	<b>TROUBLESHOOTING/SERVICE .....</b>	<b>101</b>
10.1	Overview .....	101
10.2	Troubleshooting Aids .....	102
10.3	Power-up Tests .....	104
10.4	Status Tests .....	104
10.5	Background Tests .....	105
10.6	Controller Failure Symptoms .....	107
10.7	Troubleshooting Procedures .....	108
<b>11</b>	<b>PARTS LIST .....</b>	<b>115</b>
11.1	Exploded View .....	115
<b>12</b>	<b>FUNCTION PARAMETER REFERENCE GUIDE .....</b>	<b>117</b>
12.1	Overview .....	117
12.2	Function Prompts .....	119
12.2.1	0 PCT (AUXILIARY OUTPUT LOW SCALING FACTOR) .....	119
12.2.2	100 PCT (AUXILIARY OUTPUT HIGH SCALING FACTOR) .....	119
12.2.3	4-20 RG (CURRENT DUPLEX RANGE) .....	119
12.2.4	A TUNE (AUTOTUNE KEY LOCKOUT) .....	120
12.2.5	ACTION (CONTROL OUTPUT DIRECTION) .....	120
12.2.6	ALARM1 (LATCHING ALARM FOR OUTPUT) .....	120
12.2.7	ALHYST (ALARM HYSTERESIS) .....	121
12.2.8	AT ERR (ACCUTUNE ERROR CODES) .....	121
12.2.9	AUTOMA (AUTO/MANUAL KEY LOCKOUT) .....	121
12.2.10	AUX OUT (AUXILIARY OUTPUT) .....	122
12.2.11	AxSxEV (ALARMx SETPOINTx EVENT - X = 1 OR 2) .....	123
12.2.12	AxSxHL (ALARMx SETPOINTx STATE - X = 1 OR 2) .....	123
12.2.13	AxSxTY (ALARMx SETPOINTx TYPE - X = 1 OR 2) .....	124
12.2.14	AxSxVA (ALARMx SETPOINTx VALUE - X = 1 OR 2) .....	125
12.2.15	BAUD (BAUD RATE) .....	125
12.2.16	BIAS 1 (INPUT 1 BIAS) .....	125
12.2.17	BIAS 2 (INPUT 2 BIAS) .....	125
12.2.18	BLOCK (ALARM BLOCKING) .....	126
12.2.19	BRNOUT (BURNOUT PROTECTION - SENSOR BREAK) .....	126
12.2.20	ComADD (STATION ADDRESS) .....	127
12.2.21	ComSTA (COMMUNICATIONS STATE) .....	127
12.2.22	CSP BI (COMPUTER SETPOINT BIAS) .....	127
12.2.23	CTRALG (CONTROL ALGORITHM) .....	127

12.2.24	CSRATO (COMPUTER SETPOINT RATIO) .....	129
12.2.25	CYC T1 or CT1 X3 (CYCLE TIME - HEAT).....	129
12.2.26	CYC2T2 or CT2 X3 (CYCLE TIME2 - COOL).....	130
12.2.27	DBAND (DEADBAND) .....	130
12.2.28	DECMAL (DECIMAL POINT LOCATION).....	130
12.2.29	DI COM (DIGITAL INPUT COMBINATIONS) .....	131
12.2.30	DIG IN (DIGITAL INPUT).....	131
12.2.31	DISPLAY (SINGLE DISPLAY DEFAULT).....	133
12.2.32	EMISS (EMISSIVITY) .....	133
12.2.33	ENDSEG (END SEGMENT).....	133
12.2.34	EUHRDN (RATE DOWN VALUE).....	133
12.2.35	EUHRUP (RATE UP VALUE) .....	133
12.2.36	FAILSF (FAILSAFE OUTPUT VALUE) .....	134
12.2.37	FILTR1 (INPUT 1 FILTER) .....	134
12.2.38	FILTR2 (INPUT 2 FILTER) .....	134
12.2.39	FINLSP (SINGLE SETPOINT RAMP FINAL SETPOINT).....	134
12.2.40	FREQ (POWER LINE FREQUENCY) .....	135
12.2.41	FSMODE ( FAILSAFE MODE).....	135
12.2.42	FUZZY (FUZZY OVERSHOOT SUPPRESSION).....	135
12.2.43	HYST (HYSTERESIS - OUTPUT RELAY ONLY).....	135
12.2.44	I MIN or I RPM (RESET - INTEGRAL TIME) .....	136
12.2.45	I2 MIN or I2 RPM (RESET2 - INTEGRAL TIME) .....	136
12.2.46	INCRMT (TIME COUNT INCREMENT) .....	136
12.2.47	IN1 HI (INPUT 1 HIGH RANGE VALUE) .....	137
12.2.48	IN1 LO (INPUT 1 LOW RANGE VALUE).....	137
12.2.49	IN1TYP (INPUT 1 ACTUATION TYPE).....	138
12.2.50	IN2 HI (INPUT 2 HIGH RANGE VALUE) .....	139
12.2.51	IN2 LO (INPUT 2 LOW RANGE VALUE).....	139
12.2.52	IN2TYP (INPUT 2 ACTUATION TYPE).....	140
12.2.53	L DISP (DISPLAY FOR TIMER OPTION).....	140
12.2.54	LNGUAG (LANGUAGE).....	140
12.2.55	LOCK (LOCKOUT) .....	141
12.2.56	LOOPBACK (LOCAL LOOPBACK TEST).....	141
12.2.57	LSP'S (LOCAL SETPOINT SOURCE) .....	141
12.2.58	MANRST (MANUAL RESET) .....	142
12.2.59	MINRPM (RESET UNITS) .....	142
12.2.60	OUTALG (OUTPUT ALGORITHM) .....	142
12.2.61	OUT Hi (HIGH OUTPUT LIMIT).....	143
12.2.62	OUT Lo (LOW OUTPUT LIMIT).....	143
12.2.63	PARITY (PARITY).....	143
12.2.64	PB or GAIN (PROPORTIONAL BAND or GAIN).....	144
12.2.65	PB 2 or GAIN 2 (PROPORTIONAL BAND 2 or GAIN 2).....	144
12.2.66	PBorGN (PROPORTIONAL BAND UNITS) .....	145
12.2.67	PERIOD (TIMEOUT PERIOD).....	145
12.2.68	PG END (PROGRAM TERMINATION STATE) .....	145
12.2.69	PIDSET (NUMBER OF TUNING PARAMETER SETS) .....	146
12.2.70	PVSTRT (PV START).....	147
12.2.71	PWROUT (THREE POSITION STEP CONTROL OUTPUT START-UP MODE) .	147
12.2.72	PWR UP (POWER UP CONTROLLER MODE RECALL) .....	148
12.2.73	RATE T (RATE TIME) .....	148



12.2.74	RATE2T (RATE2 TIME) .....	148
12.2.75	RATIO1 (INPUT 1 RATIO) .....	149
12.2.76	RATIO2 (INPUT 2 RATIO) .....	149
12.2.77	RECYCL (RECYCLES) .....	149
12.2.78	RLY TY (RELAY CYCLE TIME INCREMENT).....	149
12.2.79	RESET (TIMER RESET CONTROL).....	150
12.2.80	RN HLD (RUN/HOLD KEY LOCKOUT).....	150
12.2.81	RPUNIT (ENGINEERING UNITS FOR RAMP SEGMENTS) .....	150
12.2.82	RSPSRC (REMOTE SETPOINT SOURCE).....	150
12.2.83	SECUR (SECURITY CODE) .....	151
12.2.84	SGx RP (SEGMENT RAMP - x = Segment Number 1 THROUGH 12) .....	151
12.2.85	SGx SP (SEGMENT SETPOINT - x = Segment Number 1 THROUGH 12) .....	151
12.2.86	SGx TI (SEGMENT DURATION - x = Segment Number 1 THROUGH 12).....	152
12.2.87	SDMODE (SHED MODE) .....	152
12.2.88	SHD_SP (SHED SETPOINT RECALL) .....	152
12.2.89	SHDTIM (SHED TIME).....	152
12.2.90	SOKDEV (GUARANTEED SOAK DEVIATION) .....	153
12.2.91	SP Hi (SETPOINT HIGH LIMIT) .....	153
12.2.92	SP Lo (SETPOINT LOW LIMIT).....	153
12.2.93	SPPROG (SETPOINT RAMP/SOAK PROGRAM).....	154
12.2.94	SPRAMP (SINGLE SETPOINT RAMP) .....	154
12.2.95	SPRATE (SETPOINT RATE) .....	154
12.2.96	SP SEL (SETPOINT SELECT FUNCTION LOCKOUT) .....	155
12.2.97	SP TRK (SETPOINT TRACKING).....	155
12.2.98	START (TIMER START SELECTION).....	155
12.2.99	STATE (PROGRAM STATE AT PROGRAM END).....	155
12.2.100	STRSEG (START SEGMENT).....	156
12.2.101	SW VAL (AUTOMATIC SWITCHOVER VALUE).....	156
12.2.102	TI MIN (SINGLE SETPOINT RAMP TIME) .....	156
12.2.103	TIMER (TIMER OPTION).....	156
12.2.104	T <sub>o</sub> BEGN (RESET PROGRAMMING TO BEGINNING) .....	156
12.2.105	TUNE (ACCUTUNE - DEMAND TUNING) .....	157
12.2.106	TX DLY (RESPONSE DELAY) .....	157
12.2.107	UNITS (COMMUNICATION OVERRIDE UNITS) .....	157
12.2.108	UNITS (TEMPERATURE UNITS).....	157
12.2.109	XMITR1 (TRANSMITTER CHARACTERIZATION) .....	158
12.2.110	XMITR2 (TRANSMITTER CHARACTERIZATION) .....	159

**13 INDEX..... 161**

---

# Tables

Table 2-1	Condensed Specifications	4
Table 2-2	Preliminary Checks	6
Table 2-3	Control Relay Contact Information	8
Table 2-4	Alarm Relay Contact Information	8
Table 2-5	Mounting Procedure	10
Table 2-6	Permissible Wiring Bundling	12
Table 2-7	Universal Output Functionality and Restrictions	12
Table 4-1	Configuration Prompt Hierarchy	24
Table 4-2	Configuration Procedure	25
Table 4-3	TIMER Group (Numeric Code 100) Function Prompts	26
Table 4-4	TUNING Group (Numeric Code 200) Function Prompts	27
Table 4-5	SPRAMP Group (Numeric Code 300) Function Prompts	29
Table 4-6	ATUNE Group (Numeric Code 400) Function Prompts	31
Table 4-7	ALGOR Group (Numeric Code 500) Function Prompts	32
Table 4-8	INPUT1 Group (Numeric Code 600) Function Prompts	33
Table 4-9	INPUT2 Group (Numeric Code 700) Function Prompts	35
Table 4-10	CONTRL Group (Numeric Code 800) Function Prompts	36
Table 4-11	Options Group (Numeric Code 900) Function Prompts	38
Table 4-12	Communications Group (Numeric Code 1000)	39
Table 4-13	ALARMS Group (Numeric Code 1100) Function Prompts	41
Table 5-1	Procedure to Enter a Security Code	47
Table 5-2	Annunciators	49
Table 5-3	Lower Display Key Parameter Prompts	50
Table 5-4	Error Messages	51
Table 6-1	Single Display Parameters	55
Table 6-2	Procedure for Starting Up the Controller	56
Table 6-3	Control Mode Definitions	57
Table 6-4	Changing Control Modes (Dual Display Only)	58
Table 6-5	Procedure for Changing the Local Setpoints	58
Table 6-6	Procedure for Switching Between Setpoints	59
Table 6-7	Procedure for Starting “TUNE”	61
Table 6-8	Procedure for Using TUNE at Start-up for Duplex Control	62
Table 6-9	Procedure for Accessing Accutune Error Codes	63
Table 6-10	Accutune Error Codes	63
Table 6-11	Set Up Procedure	65
Table 6-12	Procedure for Switching PID SETS from the Keyboard	65
Table 6-13	Procedure for Displaying Alarm Setpoints	66
Table 6-14	Procedure for Displaying 3Pstep Motor Position	67
Table 6-15	Procedure for Setting a Failsafe Value	68
Table 6-16	Procedure for Setting a Failsafe Mode	69
Table 7-1	Running A Setpoint Ramp	73
Table 7-2	Program Contents	75
Table 7-3	Run/Monitor Functions	80
Table 8-1	Voltage and Resistance Equivalentents for Input 1 Range Values	84
Table 8-2	Equipment Needed	86
Table 8-3	Set Up Wiring Procedure for Thermocouple Inputs Using an Ice Bath	87
Table 8-4	Set Up Wiring Procedure for Thermocouple Inputs using Thermocouple Source	87

---

Table 8-5 Set Up Wiring Procedure for RTD Inputs _____	88
Table 8-6 Set Up Wiring Procedure for Radiamatic, Milliampere, Millivolts, or Volts Inputs (Except 0-10 Volts) _____	88
Table 8-7 Set Up Wiring Procedure for 0 to 10 Volts _____	89
Table 8-8 Input 1 Calibration Procedure (Numeric Code 10000) _____	90
Table 8-9 Input 2 Calibration Procedure (Numeric Code 20000) _____	93
Table 8-10 Restore Factory Calibration _____	94
Table 9-1 Set Up Wiring Procedure for Current Proportional Output _____	96
Table 9-2 Current Proportional Output Calibration Procedure (Numeric Code 30000) _____	97
Table 9-3 Set Up Wiring Procedure for Auxiliary Output _____	98
Table 9-4 Auxiliary Output Calibration Procedure (Numeric Code 50000) _____	99
Table 9-5 3 Position Step Output Calibration Procedure (Numeric Code 40000) _____	100
Table 10-1 Procedure for Identifying the Software Version _____	103
Table 10-2 Procedure for Displaying the Status Test (Numeric Code 1200) Results _____	104
Table 10-3 Background Tests _____	105
Table 10-4 Controller Failure Symptoms _____	107
Table 10-5 Troubleshooting Power Failure Symptoms _____	109
Table 10-6 Troubleshooting Current Proportional Output Failure _____	109
Table 10-7 Troubleshooting Time Proportional Output Failure _____	110
Table 10-8 Troubleshooting Current/Time or Time/Current Proportional Output Failure _____	111
Table 10-9 Troubleshooting Alarm Relay Output Failure _____	112
Table 10-10 Troubleshooting a Keyboard Failure _____	113
Table 11-1 Parts Identification _____	115
Table 11-2 Parts Not Shown _____	116
Table 12-1 Function Parameter Look-up Table _____	118

---

# Figures

Figure 1-1 UDC 2300 Operator Interface	1
Figure 2-1 Model Number Interpretation	5
Figure 2-2 Jumper Placements	7
Figure 2-3 Mounting Dimensions (not to scale)	9
Figure 2-4 Mounting Method	10
Figure 2-5 Composite Wiring Diagram	13
Figure 2-6 Mains Power Supply	13
Figure 2-7 Input 1 Connections	14
Figure 2-8 Input 2 Connections	14
Figure 2-9 Electromechanical Relay Output	14
Figure 2-10 Solid State Relay Output	15
Figure 2-11 Open Collector Relay Output	15
Figure 2-12 Current Output	16
Figure 2-13 External Solid State Relay Option (Internal Open Collector Output)	16
Figure 2-14 Three Position Step Control Connections	17
Figure 2-15 Alarm and Duplex Output Connections	17
Figure 2-16 External Interface Option Connections	18
Figure 2-17 Transmitter Power for 4-20 mA — 2 wire Transmitter Using Open Collector Alarm 2 Output (Model DC230B-XT-XX-XX-XXXXXXXX-XX-X)	19
Figure 2-18 Transmitter Power for 4-20 mA — 2 Wire Transmitter Using Auxiliary Output (Model DC230B-XX-2X-XX-XXXXXXXX-XX-X)	19
Figure 3-1 Operator Interface and Key Functions	22
Figure 5-1 Operator Interface	46
Figure 7-1 Ramp/Soak Profile Example	78
Figure 7-2 Program Record Sheet	79
Figure 8-1 Input 1 and Input 2 Wiring Terminals	85
Figure 8-2 Wiring Connections for Thermocouple Inputs Using an Ice Bath	87
Figure 8-3 Wiring Connections for Thermocouple Inputs Using Thermocouple Source	87
Figure 8-4 Wiring Connections for RTD (Resistance Thermometer Device)	88
Figure 8-5 Wiring Connections for Radiamatic, Milliampere, Millivolts, or Volts (Except 0 to 10 Volts)	89
Figure 8-6 Wiring Connections for 0 to 10 Volts	89
Figure 8-7 Wiring Connections for 4 to 20 mA Input – Input 2	91
Figure 8-8 Wiring Connections for 1 to 5 Volt Input – Input 2	92
Figure 9-1 Wiring Connections for Calibrating Current Proportional Output	96
Figure 9-2 Wiring Connections for Calibrating Auxiliary Output	98
Figure 11-1 UDC 2300 Exploded View	115

# 1 Introduction

## 1.1 Overview

The UDC 2300 is a microprocessor-based stand-alone controller. It combines reliability and operating simplicity in a cost-effective 1/4-DIN size controller.

The UDC 2300 monitors and controls temperatures and other variables in applications such as environmental chambers, plastic processing machines, furnaces and ovens, and packaging machinery.

Its features include:

- *Universal AC Power Supply,*
- *Input/Output Isolation,*
- *Isolated Auxiliary Current Output / Digital Input*
- *Modbus and ASCII Communications*
- *Timer*
- *Accutune II Tuning with Fuzzy Logic Overshoot Suppression.*
- *2<sup>nd</sup> Input (Remote Setpoint)*
- *Setpoint Ramp/Rate/Program*
- *Three Position Step Control*
- *Duplex (Heat/Cool)*

The UDC 2300 is also downward compatible with existing UDC 2000 applications and installations **except** for RTD and 0-10 Volt inputs.

See wiring diagrams in Section 2 - Installation.

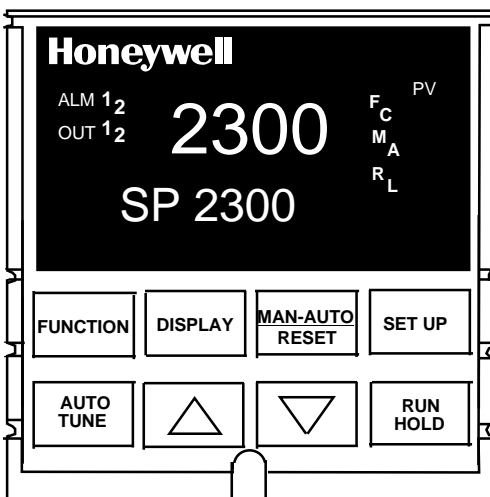

Figure 1-1 UDC 2300 Operator Interface

## 1.2 CE Conformity (Europe)

This product is in conformity with the protection requirements of the following European Council Directives: **73/23/EEC**, the Low Voltage Directive, and **89/336/EEC**, the EMC Directive. Conformity of this product with any other “CE Mark” Directive(s) shall not be assumed.

*Product Classification:* Class I: Permanently connected, panel-mounted Industrial Control Equipment with protective earthing (grounding). (EN61010-1).

*Enclosure Rating:* Panel-mounted equipment, IP 00. This controller must be panel-mounted. Terminals must be enclosed within the panel. Front panel IP 65 (IEC 529).

*Installation Category (Overvoltage Category):* Category II: Energy-consuming equipment supplied from the fixed installation, local level appliances, and Industrial Control Equipment. (EN61010-1)

*Pollution Degree:* Pollution Degree 2: Normally non-conductive pollution with occasional conductivity caused by condensation. (Ref. IEC 664-1)

*EMC Classification:* Group 1, Class A, ISM Equipment (EN55011, emissions), Industrial Equipment (EN50082-2, immunity)

*Method of EMC Assessment:* Technical File (TF)

*Declaration of Conformity:* 51309602-000

Deviation from the installation conditions specified in this manual, and the special conditions for CE conformity in Subsection 2.1, may invalidate this product’s conformity with the Low Voltage and EMC Directives.

## 2 Installation

### 2.1 Overview

#### Introduction

Installation of the UDC 2300 consists of mounting and wiring the controller according to the instructions given in this section. Read the pre-installation information, check the model number interpretation (Subsection 2.2), and become familiar with your model selections, then proceed with installation.

#### What's in this section?

The following topics are covered in this section.

TOPIC	See Page
2.1 Overview	3
2.2 Model Number Interpretation	5
2.3 Preliminary Checks	6
2.4 Control and Alarm Relay Contact Information	8
2.5 Mounting	9
2.6 Wiring	11
2.7 Wiring Diagrams	12
Composite Wiring Diagram	13
AC Line Voltage	13
Input 1 Connections	14
Input 2 Connections	14
Relay Output	
Electromechanical	14
Solid State	15
Open Collector	15
Current Output Connections	16
External Solid State Relay Output Option	16
Three Position Step Control Connections	17
Alarm and Duplex Output Connections	17

### Pre-installation Information

If the controller has not been removed from its shipping carton, inspect the carton for damage then remove the controller.

- Inspect the unit for any obvious shipping damage and report any damage due to transit to the carrier.
- Make sure a bag containing mounting hardware is included in the carton with the controller.
- Check that the model number shown on the inside of the case agrees with what you have ordered.

### Condensed Specifications

Honeywell recommends that you review and adhere to the operating limits listed in Table 2-1 when you install your controller.

**Table 2-1 Condensed Specifications**

<p><b>Operating Limits</b></p>	<p><b>Ambient Temperature:</b> 32 °F to 131 °F (0 °C to 55 °C)  <b>Relative Humidity:</b> 5 % to 90 % RH up to 104 °F (40 °C)  <b>Vibration:</b>  <i>Frequency:</i> 0 to 200 Hz  <i>Acceleration:</i> 0.6g  <b>Mechanical Shock:</b>  <i>Acceleration:</i> 5g  <i>Duration:</i> 30 ms  <b>Power:</b>            90 Vac to 264 Vac, 50/60 Hz            (CSA models rated to 250 Vac maximum)  <b>Power Consumption:</b> 12 VA maximum</p>
<p><b>Accuracy</b></p>	<p>± 0.25 % of span typical            ± 1 digit for display            15-bit resolution typical</p>
<p><b>CE Conformity Special Conditions (Europe)</b></p>	<p>Shielded twisted-pair cables are required for all analog I/O, process variable, RTD, thermocouple, dc millivolt, low level signal, 4-20 mA, digital I/O, and computer interface circuits.   <i>Refer to 51-52-05-01, How to Apply Digital Instrumentation in Severe Electrical Noise Environments, for additional information.</i></p>



## 2.2 Model Number Interpretation

### Introduction

Write the model number into the spaces provided in Figure 2-1 and compare it to the model number interpretation. This information will also be useful when you wire your controller.

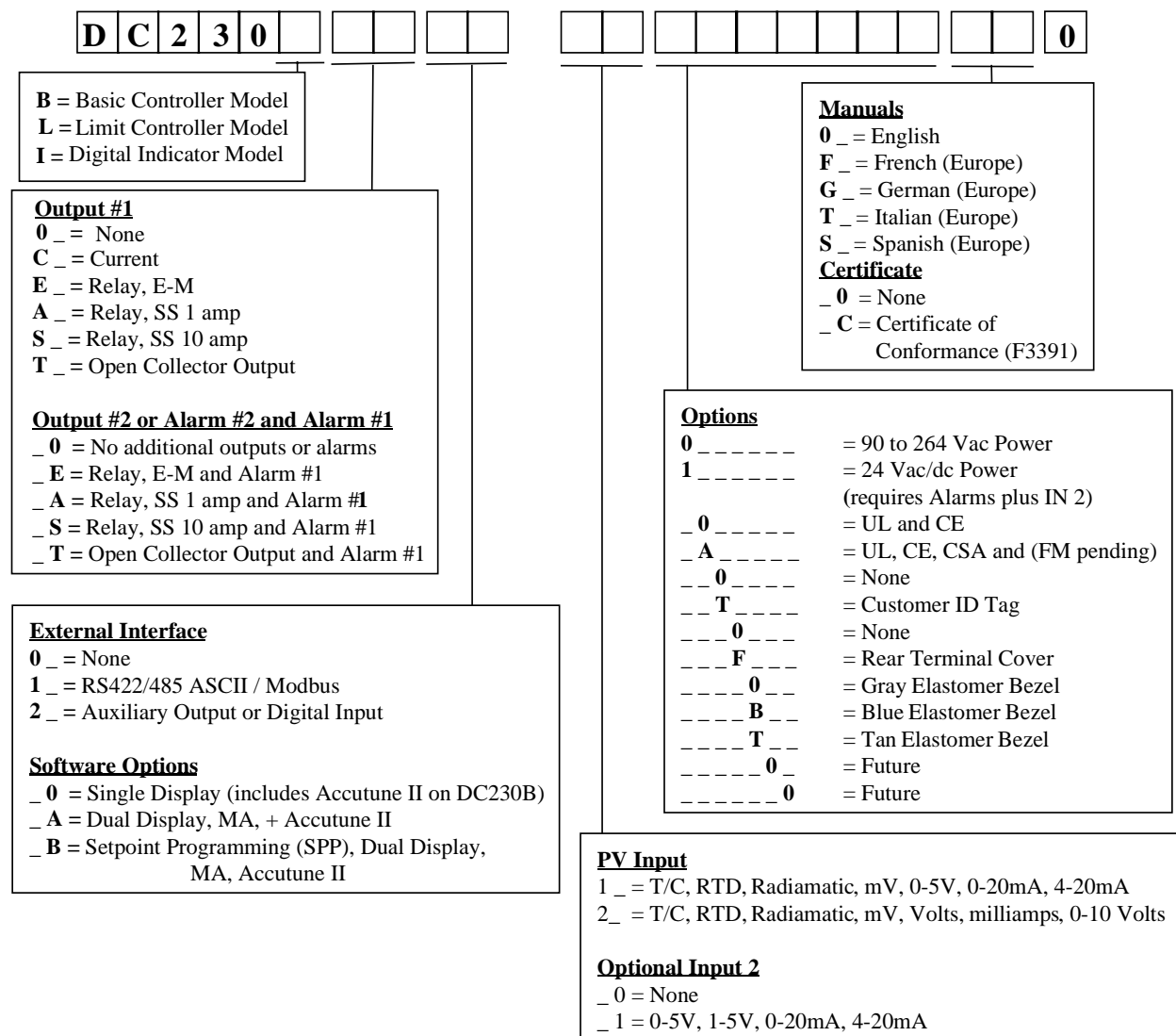

Figure 2-1 Model Number Interpretation

## 2.3 Preliminary Checks

### Introduction

Before you install the controller, remove the chassis and make any preliminary checks necessary that are listed in Table 2-2. Figure 2-2 shows the locations for jumper placements.

**Table 2-2 Preliminary Checks**

Check Number	Preliminary Check	Description
1	Input 1 Jumper Placement	Check the internal jumper for <b>INPUT 1</b> to make sure it is set for the correct input type. The jumper is located at position S101 on the printed wiring board. Figure 2-2 shows the location of the jumper and position selections.
2	Optional Input 2 (RSP) Jumper Placement	Check the internal jumper for <b>INPUT 2</b> to make sure it is set for the correct input type. The jumper is located at position S201 on the printed wiring board. Figure 2-2 shows the location of the jumper and position selections.
3	Control Relay 1 and Current Output	Check the internal jumper (W101) for <b>CONTROL</b> . The relay is shipped as N.O. (Normally Open). Figure 2-2 shows the location of the jumper and position selections.  See Table 2-3 for <b>Control Relay</b> contact information
4	Control Relay 2 and Alarm Relay Action.	The controller has been shipped with ALARM relays configured for N.C. (Normally Closed). If you want to change to N.O. refer to Figure 2-2, Jumper positions W201 and W202:  W201 is the <b>ALARM RELAY 1</b> jumper.  W202 is the jumper for <b>CONTROL RELAY #2</b> for Duplex Output or 3 position step control and an <b>ALARM RELAY 2</b> for all others.  See Table 2-3 for <b>Control Relay</b> contact information, and Table 2-4 for <b>Alarm Relay</b> contact information.  See Alarm Relay Caution Note, Page 8.

---

**Note:** Solid State and Open Collector must have jumper set to N.O. (Normally Open).

3 Position Step and Time Duplex must have Output 2 jumper (W202) set to N.O.

### Jumper Placements

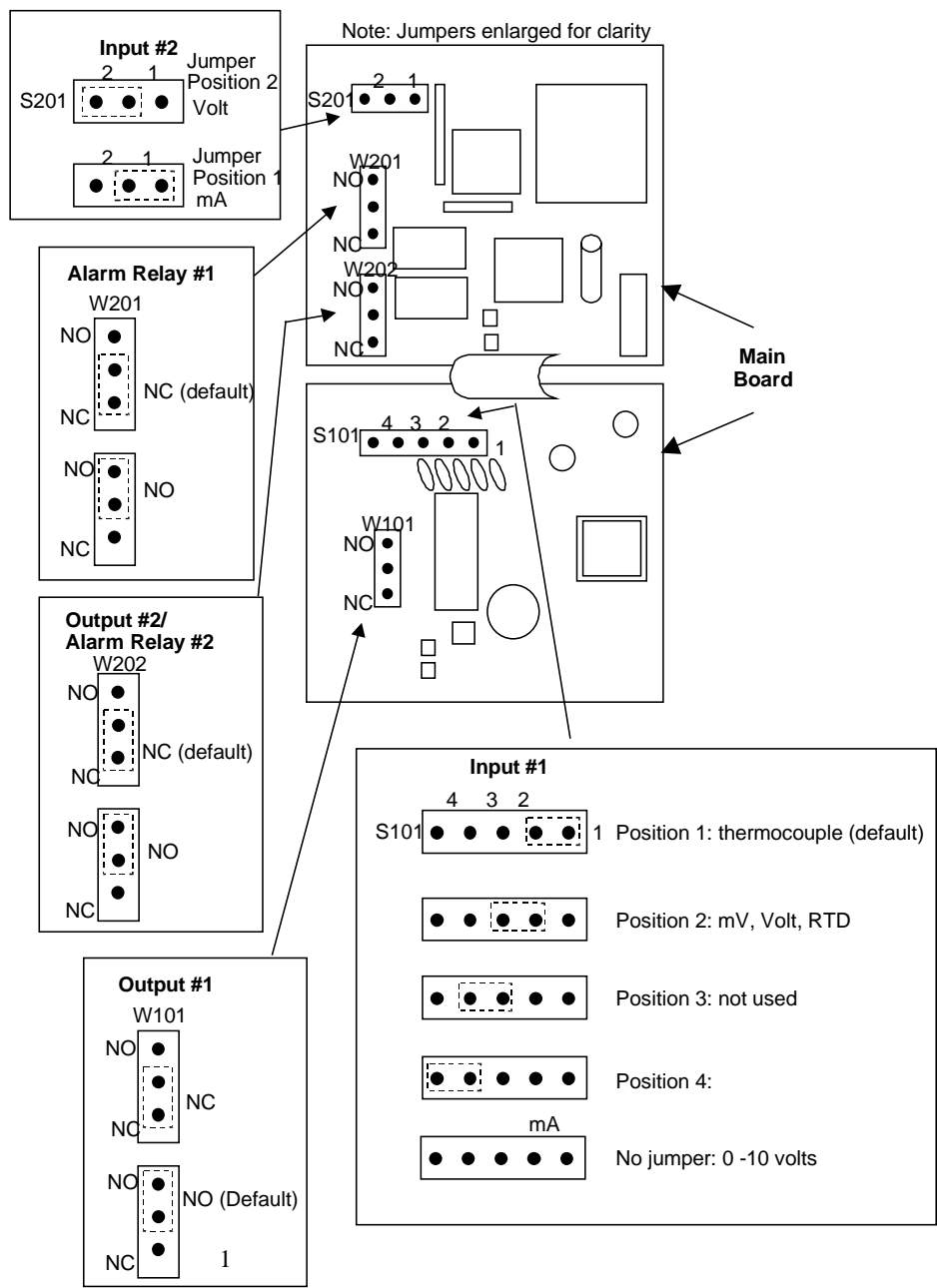

1. For Current Output use the N.O. position

Figure 2-2 Jumper Placements

## 2.4 Control and Alarm Relay Contact Information

### Control Relays

**ATTENTION**

Control relays operate in the standard control mode (that is, energized when output state is on).

**Table 2-3 Control Relay Contact Information**

Unit Power	Control Relay Wiring	Control Relay Contact	#1 or #2 Output Indicator Status
Off	N.O.	Open	Off
	N.C.	Closed	
On	N.O.	Open Closed	Off On
	N.C.	Closed Open	Off On

### Alarm Relays

**ATTENTION**

Alarm relays are designed to operate in a failsafe mode (that is, de-energized during alarm state). This results in alarm actuation when power is OFF or when initially applied, until the unit completes self diagnostics. If power is lost to the unit, the alarms will function.

**Table 2-4 Alarm Relay Contact Information**

Unit Power	Alarm Relay Wiring	Variable NOT in Alarm State		Variable in Alarm State	
		Relay Contact	Indicators	Relay Contact	Indicators
Off	N.O.	Open	Off	Open	Off
	N.C.	Closed		Closed	
On	N.O.	Closed	Off	Open	On
	N.C.	Open		Closed	

## 2.5 Mounting

### Physical Considerations

The controller can be mounted on either a vertical or tilted panel using the mounting kit supplied. Adequate access space must be available at the back of the panel for installation and servicing activities.

- Overall dimensions and panel cutout requirements for mounting the controller are shown in Figure 2-3.
- The controller’s mounting enclosure must be grounded according to CSA standard C22.2 No. 0.4 or Factory Mutual Class No. 3820 paragraph 6.1.5.
- The front panel is moisture rated NEMA 3/IP65 (IEC) when properly installed with panel gasket.

### Overall Dimensions

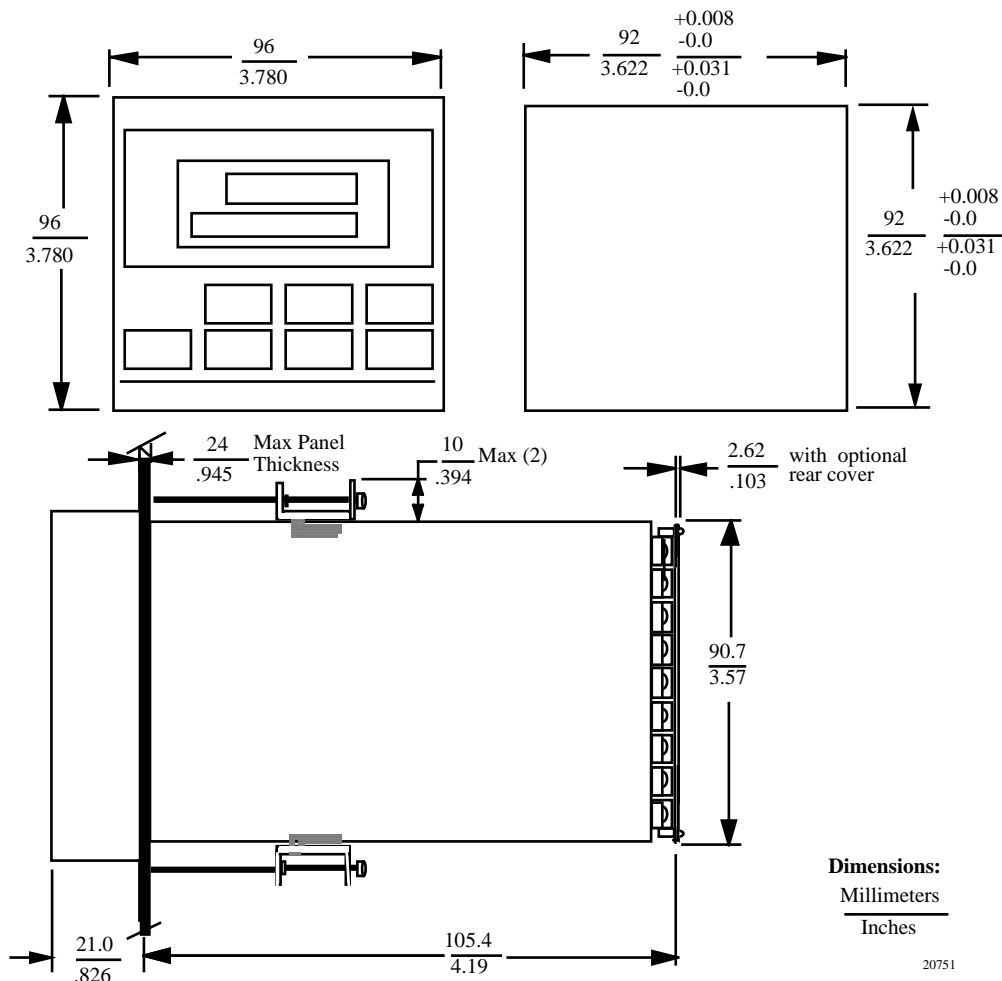

**Figure 2-3 Mounting Dimensions (not to scale)**

## Mounting Method

Before mounting the controller, refer to the nameplate on the outside of the case and make a note of the model number. It will help later when selecting the proper wiring configuration.

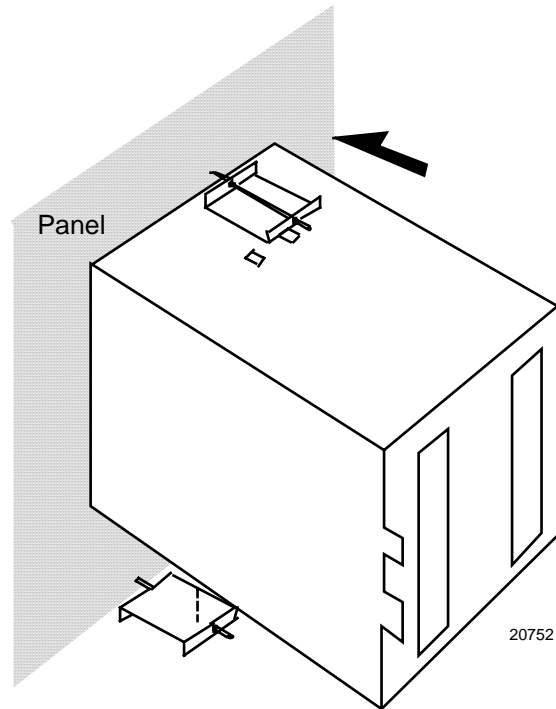

**Figure 2-4 Mounting Method**

## Mounting Procedure

**Table 2-5 Mounting Procedure**

Step	Action
1	Mark and cut out the controller hole in the panel according to the dimension information in Figure 2-3.
2	Remove the screw cover and loosen the screw on the front of the controller. Pull the chassis out of the case.
3	Orient the case properly and slide it through the panel hole from the front.
4	Remove the mounting kit from the shipping container and install the kit as follows: <ul style="list-style-type: none"> <li data-bbox="402 1545 1068 1577">• Install the screws into the threaded holes of the clips.</li> <li data-bbox="402 1587 1393 1619">• Insert the prongs of the clips into the two holes in the top and bottom of the case.</li> <li data-bbox="402 1629 1125 1661">• Tighten both screws to secure the case against the panel.</li> <li data-bbox="402 1671 1401 1732">• Carefully slide the chassis assembly into the case, press to close, and tighten the screw. Replace the screw cover.</li> </ul>

## 2.6 Wiring

### Electrical Considerations



The controller is considered “rack and panel mounted equipment” per EN61010-1, Safety Requirements for Electrical Equipment for Measurement, Control, and Laboratory Use, Part 1: General Requirements. Conformity with 72/23/EEC, the Low Voltage Directive requires the user to provide adequate protection against a shock hazard. The user shall install this controller in an enclosure that limits OPERATOR access to the rear terminals.

### Mains Power Supply

This equipment is suitable for connection to 90 to 264 Vac, 50/60 Hz, power supply mains. It is the user’s responsibility to provide a switch and non-time delay (North America), quick-acting, high breaking capacity, Type F (Europe), 1/2A, 250V fuse(s), or circuit-breaker, as part of the installation. The switch or circuit-breaker shall be located in close proximity to the controller, within easy reach of the OPERATOR. The switch or circuit-breaker shall be marked as the disconnecting device for the controller.

### Controller Grounding

PROTECTIVE BONDING (grounding) of this controller and the enclosure in which it is installed shall be in accordance with National and Local electrical codes. To minimize electrical noise and transients that may adversely affect the system, supplementary bonding of the controller enclosure to a local ground, using a No. 12 (4 mm<sup>2</sup>) copper conductor, is recommended.

### Control/Alarm Circuit Wiring

The insulation of wires connected to the Control/Alarm terminals shall be rated for the highest voltage involved. Extra Low Voltage (ELV) wiring (input, current output, and low voltage Control/Alarm circuits) shall be separated from HAZARDOUS LIVE (>30 Vac, 42.4 V<sub>peak</sub>, or 60 V<sub>dc</sub>) wiring per Permissible Wiring Bundling, Table 2-6.

### Electrical Noise Precautions

Electrical noise is composed of unabated electrical signals which produce undesirable effects in measurements and control circuits.

Digital equipment is especially sensitive to the effects of electrical noise. Your controller has built-in circuits to reduce the effect of electrical noise from various sources. If there is a need to further reduce these effects:

- *Separate External Wiring*—Separate connecting wires into bundles (See Permissible Wiring Bundling - Table 2-6) and route the individual bundles through separate conduit metal trays.  
*Use Suppression Devices*—For additional noise protection, you may want to add suppression devices at the external source. Appropriate suppression devices are commercially available.

#### ATTENTION

For additional noise information, refer to document number 51-52-05-01, *How to Apply Digital Instrumentation in Severe Electrical Noise Environments*.

## Permissible Wiring Bundling

**Table 2-6 Permissible Wiring Bundling**

Bundle No.	Wire Functions
1	<ul style="list-style-type: none"> <li>Line power wiring</li> <li>Earth ground wiring</li> <li>Control relay output wiring</li> <li>Line voltage alarm wiring</li> </ul>
2	<p><b>Analog</b> signal wire, such as:</p> <ul style="list-style-type: none"> <li>Input signal wire (thermocouple, 4 to 20 mA, etc.)</li> <li>4-20 mA output signal wiring</li> </ul> <p><b>Digital</b> input signals</p>
3	<ul style="list-style-type: none"> <li>Low voltage alarm relay output wiring</li> <li>Low voltage wiring to solid state type control circuits</li> </ul>

## 2.7 Wiring Diagrams

### Identify Your Wiring Requirements

To determine the appropriate diagrams for wiring your controller, refer to the model number interpretation in this section. The model number of the controller can be found on the outside of the case.

### Universal Output Functionality and Restrictions

**Table 2-7 Universal Output Functionality and Restrictions**

Output Type	Output/Socket				
	Current Output	Relay #1	Relay #2	Relay #3	Auxiliary Output
Time Simplex 1	N/I	Output 1	Alarm 2	Alarm 1	Not Needed
Time Simplex 2	N/A	N/I	Output	Alarm 1	Not Needed
Current Simplex	Output	N/I	Alarm 2	Alarm 1	Not Needed
Time Duplex or TPSC	N/I	Output 1	Output 2	Alarm 1	Not Needed
Current Dup. 100 %	Output 1	N/I	Alarm 2	Alarm 1	Not Needed
Current Dup. 50 %	Output 1	N/I	Alarm 2	Alarm 1	Output 2
Current/Time	Output 1	N/I	Output 2	Alarm 1	Not Needed
Time/Current	Output 2	N/I	Output 1	Alarm 1	Not Needed

N/I = Not Installed

N/A = The output form or the individual output is Not Available or is not used for this output form.

Not Needed = Auxiliary Output is not needed to provide the desired output function and can be used for another purpose. Auxiliary Output could also be used as a substitute for current Output 1.



## Wiring the Controller

Using the information contained in the model number, select the appropriate wiring diagrams from the composite wiring diagram below. Refer to the individual diagrams listed to wire the controller according to your requirements.

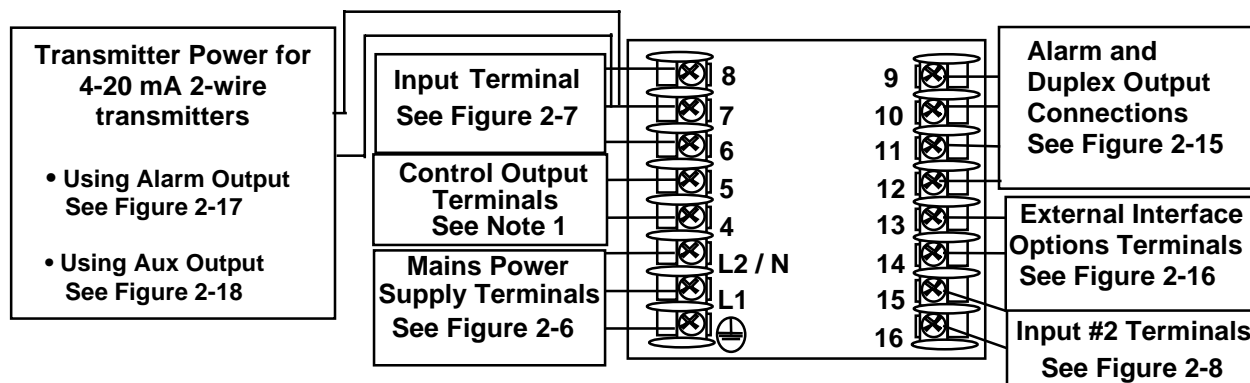

NOTE1: Time Proportional Electromechanical Relay Output – See Figure 2-9  
 Time Proportional Solid State Relay Output – See Figure 2-10  
 Time Proportional Open Collector Output – See Figure 2-11  
 Current Output – See Figure 2-12  
 External Solid State Relay Output – See Figure 2-13  
 Three Position Step Control Output – See Figure 2-14

24855

Figure 2-5 Composite Wiring Diagram

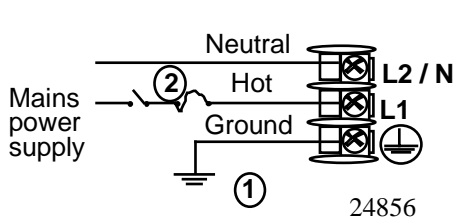

24856

① PROTECTIVE BONDING (grounding) of this controller and the enclosure in which it is installed, shall be in accordance with National and Local electrical codes. To minimize electrical noise and transients that may adversely affect the system, supplementary bonding of the controller enclosure to a local ground, using a No. 12 (4 mm<sup>2</sup>) copper conductor, is recommended. **Before powering the controller, see “Preliminary Checks” in this section of the Product manual for switch and jumper settings.**

② Provide a switch and non-time delay (North America), quick-acting, high breaking capacity, type F (Europe), 1/2 A, 250 V fuse(s), or circuit-breaker as part of the installation.

Figure 2-6 Mains Power Supply

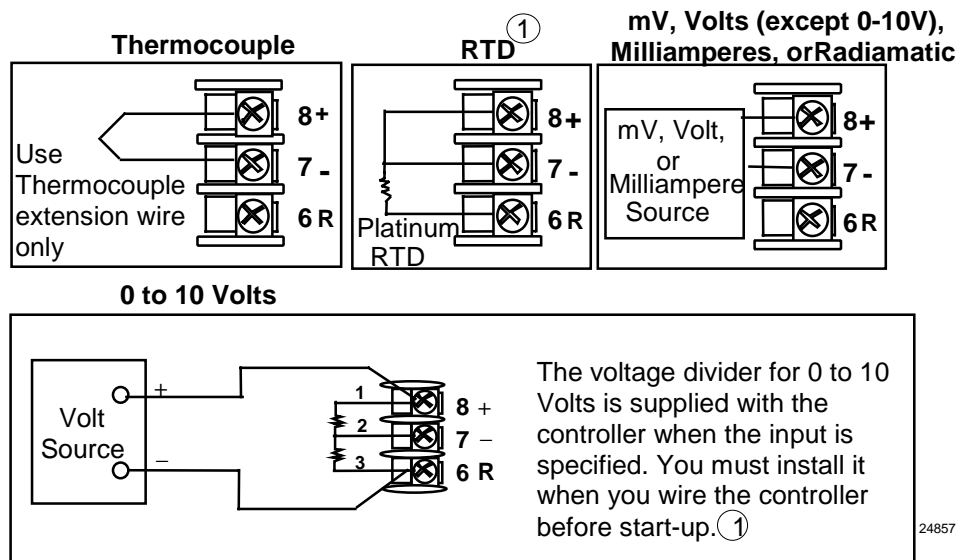

① These inputs are wired differently than the UDC2000

**Figure 2-7 Input 1 Connections**

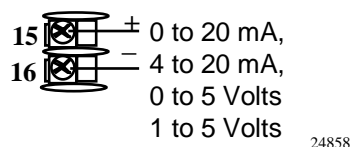

See “Preliminary Checks” in this section of the Product Manual for jumper selections.

**Figure 2-8 Input 2 Connections**

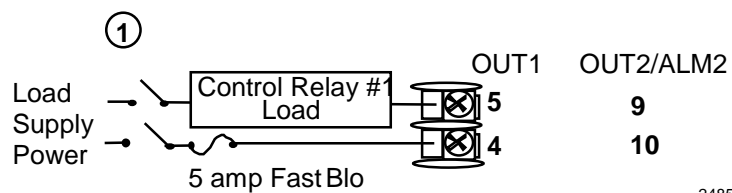

① Control relays 1 and 2 are configured N.O. as shipped. Alarm relays 1 and 2 are configured N.C. as shipped. N.O. or N.C. configurations are selectable by jumpers on the Main printed wiring boards. See “Preliminary Checks” in this section of the Product Manual for details. Each SPST relay is rated at 5A, 120 Vac and 30 Vdc, 2.5 A 240 Vac. User-provided fuses should be sized accordingly. For solid state relay outputs, see Figure 2-13.

See Figure 2-15 for Alarm and Duplex Output Connections.  
See Table 2-3 and Table 2-4 for Control and Alarm Relay Contact information.

**Figure 2-9 Electromechanical Relay Output**

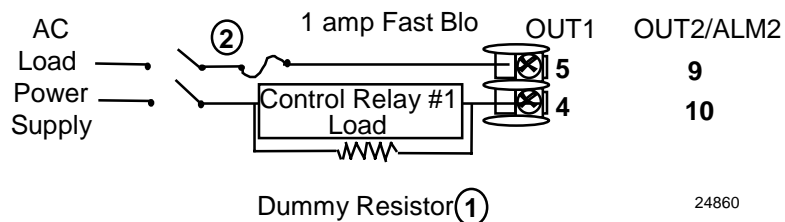

- ① If the load current is less than the minimum rated value of 20 mA, there may be a residual voltage across both ends of the load even if the relay is turned off. Use a dummy resistor as shown to counteract this. The total current through the resistor and the load current must exceed 20 mA.
- ② Solid State relay is rated at 1 Amp at 25°C, linearly derated to 0.5 Amp at 55°C. Customer should size fuse accordingly.

See Figure 2-15 for Alarm and Duplex Output Connections.  
See Table 2-3 and Table 2-4 for Control and Alarm Relay Contact information.

**Figure 2-10 Solid State Relay Output**

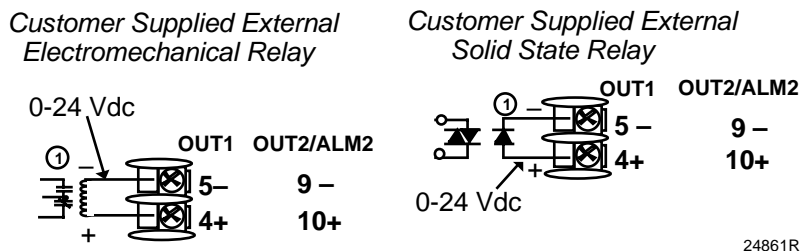

- ① **CAUTION** Open collector outputs are internally powered at 24 Vdc. Connecting an external supply will damage the controller. External relays should be fused between power and relay load.

See Figure 2-15 for Alarm and Duplex Output Connections.  
See Tables 2-3 and 2-4 for Control and Alarm Relay Contact information.

**Figure 2-11 Open Collector Relay Output**

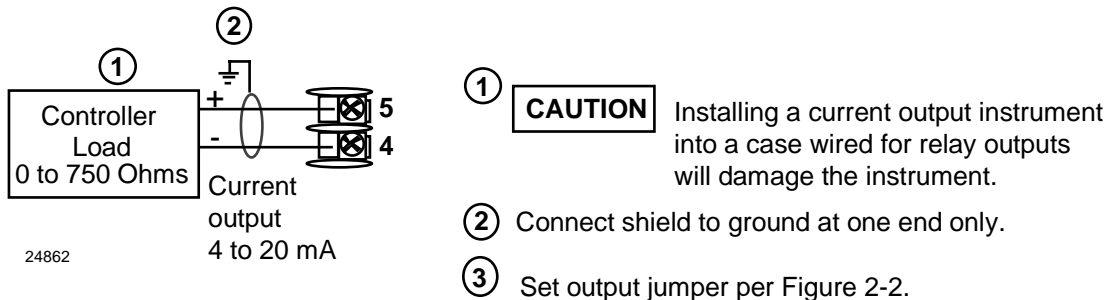

See Figure 2-15 for Alarm and Duplex Output Connections.  
See Table 2-3 and Table 2-4 for Control and Alarm Relay Contact information.

**Figure 2-12 Current Output**

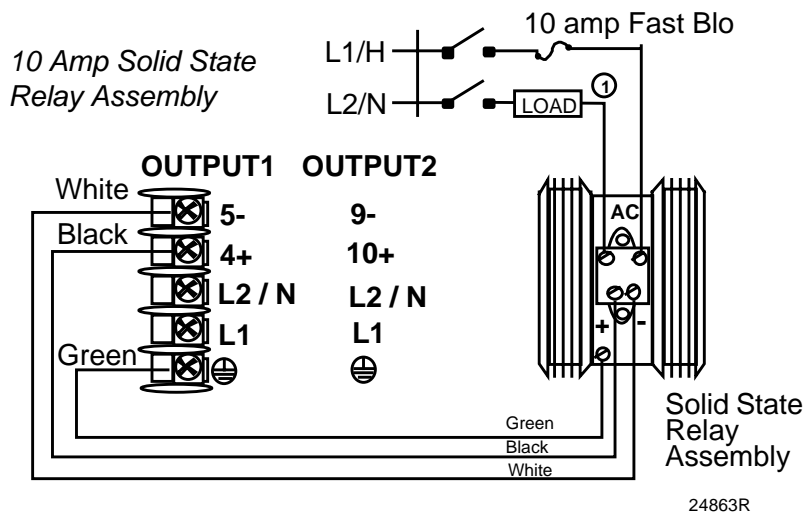

**Figure 2-13 External Solid State Relay Option (Internal Open Collector Output)**

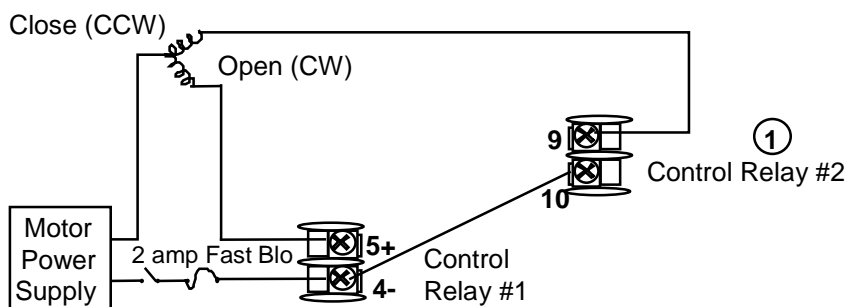

24864

- ① Alarm #2 is not available with Three Position Step Control.

See Figure 2-15 for Alarm and Duplex Output Connections.

**Figure 2-14 Three Position Step Control Connections**

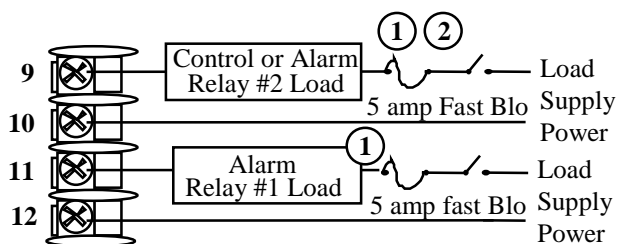

24867

- ① Control relays 1 and 2 are configured N.O. as shipped. Alarm relays 1 and 2 are configured N.C. as shipped. N.O. or N.C. configurations are selectable by jumpers on main printed wiring boards. See "Preliminary Checks" in this sections of the Product Manual for details. Each SPST relay is rated at 5 A, 120 Vac and 24 Vdc, 2.5 A, 240 Vac.
- ② Alarm #2 not available for Time Proportional Duplex or Three Position Step Control.

**Figure 2-15 Alarm and Duplex Output Connections**

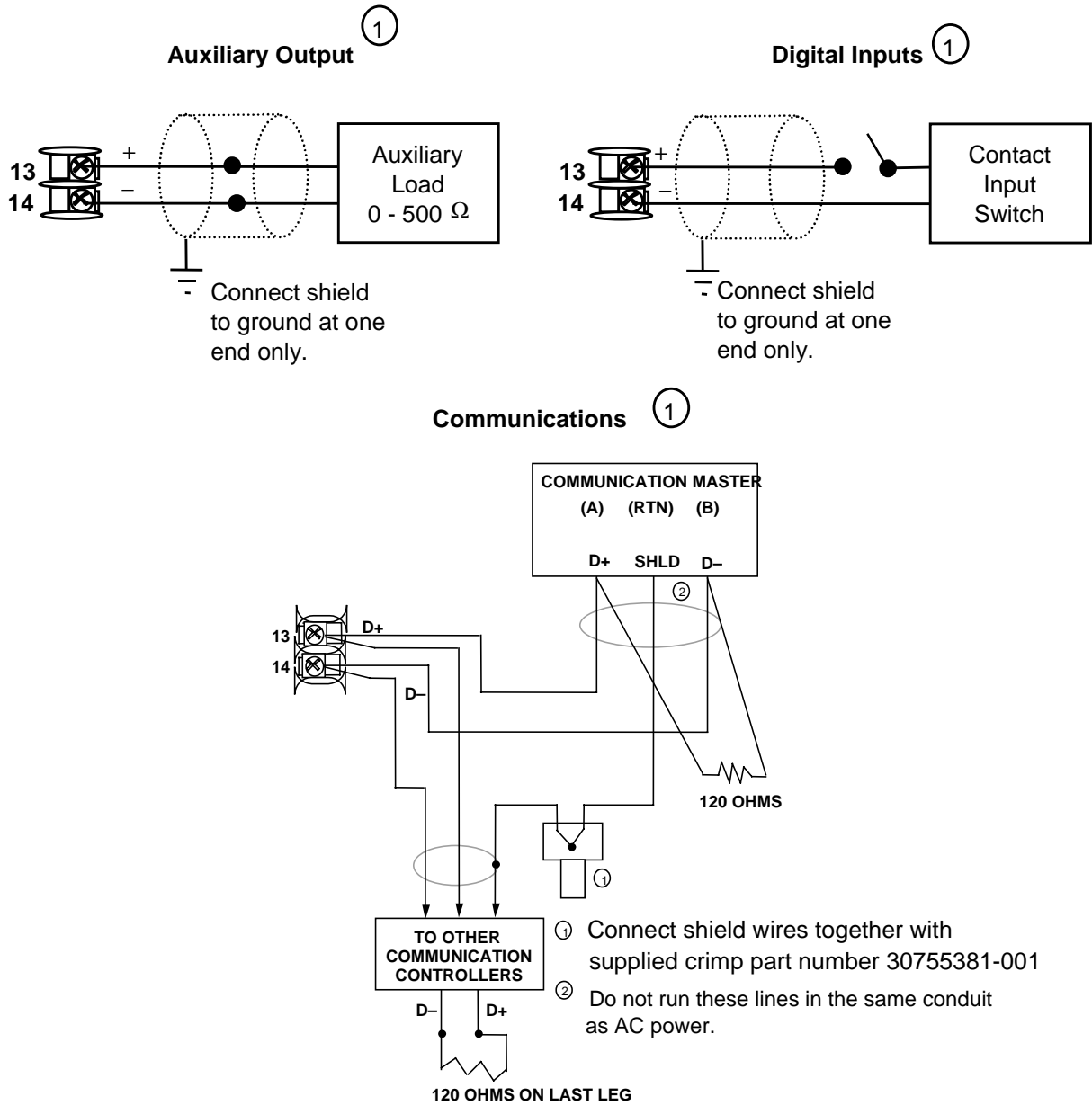

① AuxOut , Digital Input and Communications are mutually exclusive.

**Figure 2-16 External Interface Option Connections**

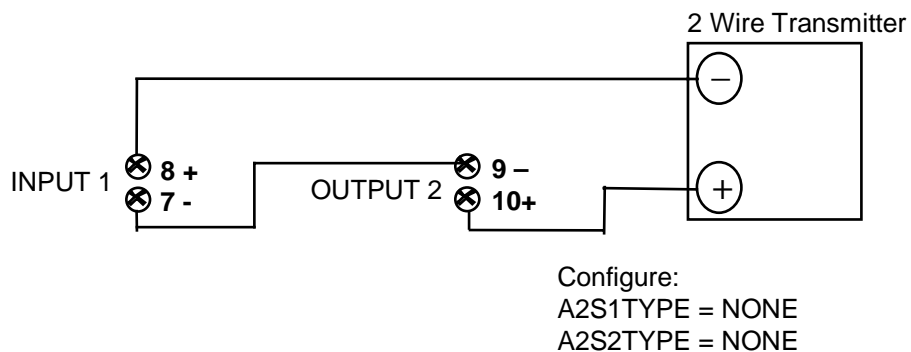

**Figure 2-17 Transmitter Power for 4-20 mA — 2 wire Transmitter Using Open Collector Alarm 2 Output (Model DC230B-XT-XX-XX-XXXXXXXX-XX-X)**

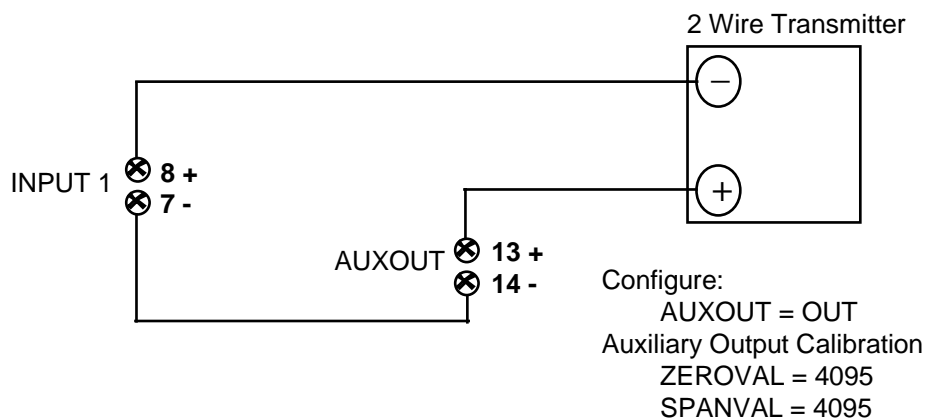

**Figure 2-18 Transmitter Power for 4-20 mA — 2 Wire Transmitter Using Auxiliary Output (Model DC230B-XX-2X-XX-XXXXXXXX-XX-X)**





## 3 Initial Start-up

### 3.1 Overview

This section gives you the information necessary to start up your controller prior to configuration. Review the Operator Interface portion to make sure you are familiar with the indicator definitions and key functions.

### 3.2 Powering Up the Controller

#### Apply Power

When power is applied, the controller will run three diagnostic tests. After these tests are completed, “TEST DONE” is displayed.

#### Test Failures

If one or more of these tests fail, the controller will go to the Failsafe Manual Mode, and FAILSF will flash in the lower display and a message indicating which test failed will appear in the lower display. Then, “DONE” will appear in the lower display.

### 3.3 Operator Interface and Key Functions

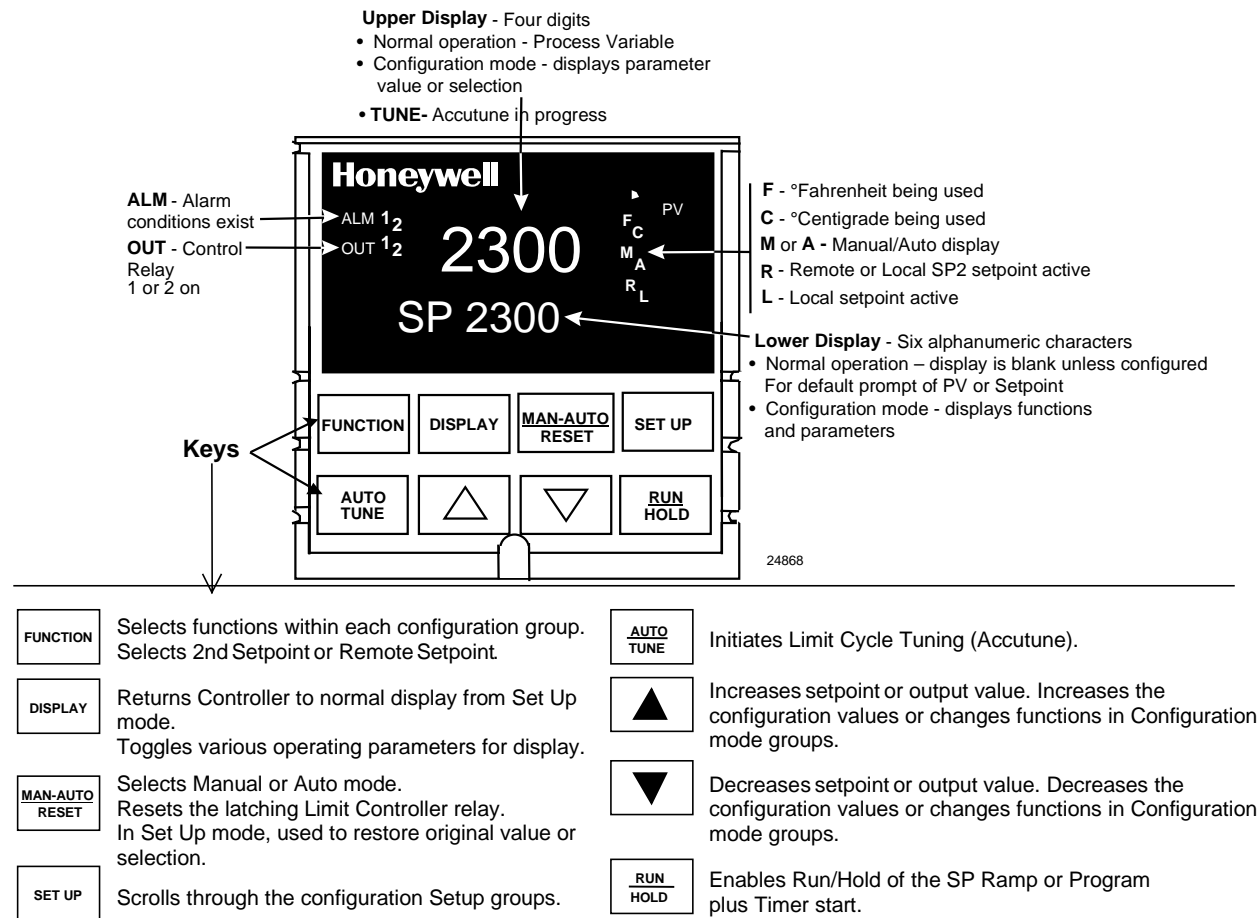

**Figure 3-1 Operator Interface and Key Functions**

### 3.4 Key Error Message

When a key is pressed and the prompt KEYERR appears in the lower display, it will be for one of the following reasons:

- parameter is not available,
- not in Set Up mode, press **SET UP** key first,
- key malfunction.

## 4 Configuration

### 4.1 Overview

#### Introduction

Configuration is a dedicated operation where you use straightforward keystroke sequences to select and establish (configure) pertinent control data best suited for your application.

To assist you in the configuration process, there are prompts that appear in the upper and lower displays. These prompts let you know what group of configuration data (Set Up prompts) you are working with and also, the specific parameters (Function prompts) associated with each group.

Figure 3-1 shows you an overview of the prompt hierarchy as they appear in the controller.

As you will see, the configuration data is divided into 11 main Set Up groups plus prompts for calibration and prompts that show the status of the continuous background tests that are being performed.

#### What's in this section?

The following topics are covered in this section.

TOPIC	See Page
4.1 Overview	23
4.2 Configuration Prompt Hierarchy	24
4.3 Configuration Procedure	25
4.4 Timer Set Up Group	26
4.5 Tuning Set Up Group	27
4.6 SP Ramp Set Up Group	29
4.7 Accutune Set Up Group	31
4.8 Algorithm Set Up Group	32
4.9 Input 1 Set Up Group	33
4.10 Input 2 Set Up Group	35
4.11 Control Set Up Group	36
4.12 Options Set Up Group	38
4.13 Communications Set Up Group	39
4.14 Alarms Set Up Group	41
4.15 Configuration Record Sheet	43

## 4.2 Configuration Prompt Hierarchy

Table 4-1 Configuration Prompt Hierarchy

Set Up Group	Function Prompts
<b>TIMER</b>	TIMER PERIOD START L DISP RESET INCRMT
<b>TUNING</b>	PB or GAIN RATE T I MIN or I RPM MANRST PB 2 or GAIN 2 RATE2T I2 MIN or I2 RPM CYC T1 or CT1 X3 CYC2T2 or CT2 X3 SECUR LOCK AUTOMA A TUNE RN HLD SP SL
<b>SPRAMP</b>	SPRAMP TI MIN FINLSP SPRATE EUHRUP EUHRDN SPPROG STRSEG ENDSEG RPUNIT RECYCL SOKDEV PG END STATE ToBEGN PVSTRT SGx RP* SGxSP* SGx TI* * x = 1 to 12. Program concludes after segment 12
<b>ATUNE</b>	FUZZY TUNE AT ERR
<b>ALGOR</b>	CTRALG OUTALG 4-20RG RLY TYP
<b>INPUT1</b>	DECMAL UNITS IN1TYP XMITR1 IN1 HI IN1 LO RATIO1 BIAS 1 FILTR1 BRNOUT EMISS FREQ DISPLY LNGUAG
<b>INPUT2</b>	IN2TYP XMITR2 IN2 HI IN2 LO RATIO2 BIAS 2 FILTR2
<b>CONTRL</b>	PIDSET SW VAL LSP'S RSP SRC SP TRK PWR UP PWROUT SP Hi SP Lo ACTION OUT Hi OUT Lo D BAND HYST FAILSF FSMODE PBoGN MINRPM
<b>OPTIONS</b>	AUXOUT 0 PCT 100 PCT DIG IN DI COM
<b>COM</b>	ComSTA ComADD SDENAB SHDTIM PARITY BAUD WS_FLT TXDLY SDMODE SHD_SP UNITS CSRATO CSP_BI LOOPBK
<b>ALARMS</b>	A1S1VA A1S2VA A2S1VA A2S2VA A1S1TY A1S2TY A2S1TY A2S2TY A1S1HL A1S1EV A1S2HL A1S2EV A2S1HL A2S1EV A2S2HL A2S2EV ALHYST ALARM1 BLOCK
<b>STATUS</b>	VERSON FAILSF TESTS

### 4.3 Configuration Procedure

#### Introduction

Each of the Set Up groups and their functions are pre-configured at the factory. The factory settings are shown in Table 4-3 through Table 4-13 that follow this procedure.

If you want to change any of these selections or values, follow the procedure in Table 4-2. This procedure tells you the keys to press to get to any Set Up group and any associated Function parameter prompt.

**If you need a detailed explanation of any prompt, refer to Section 12 – Function Parameter Reference Guide.**

#### Procedure

**ATTENTION**

The prompting scrolls at a rate of 2/3 seconds when the **SET UP** or **FUNCTION** key is held in. Also, **[▲]** **[▼]** keys will move group prompts forward or backward at a rate twice as fast.

**Table 4-2 Configuration Procedure**

Step	Operation	Press	Result
1	Enter Set Up Mode	<b>SET UP</b>	<i>Upper Display = SET</i> <i>Lower Display = TIMER</i> (This is the first Set Up Group title)
2	Select any Set Up Group	<b>SET UP</b>	Sequentially displays the other Set Up group titles shown in the prompt hierarchy in Table 4-1 Configuration Prompt Hierarchy. You can also use the <b>[▲]</b> <b>[▼]</b> keys to scan the Set Up groups in both directions. Stop at the Set Up group title that describes the group of parameters you want to configure. Then proceed to the next step.
3	Select a Function Parameter	<b>FUNCTION</b>	<i>Upper Display =</i> the current value or selection for the first function prompt of the selected Set Up group. <i>Lower Display =</i> the first Function prompt within that Set Up group. Sequentially displays the other function prompts of the Set Up group you have selected. Stop at the function prompt that you want to change, then proceed to the next step.
4	Change the Value or Selection	<b>[▲]</b> <b>[▼]</b>	Increments or decrements the value or selection that appears for the selected function prompt. If you change the value or selection of a parameter while in Set Up mode then decide not to enter it, press <b>[MAN-AUTO/RESET]</b> once—the original value or selection is recalled.
5	Enter the Value or Selection	<b>FUNCTION</b>	Enters value or selection made into memory after another key is pressed.
6	Exit Configuration	<b>DISPLAY</b>	Exits configuration mode and returns controller to the same state it was in immediately preceding entry into the Set Up mode. It stores any changes you have made. If you do not press any keys for 30 seconds, the controller times out and reverts to the mode and display used prior to entry into Set Up mode.

## 4.4 Timer Set Up Group

### Introduction

The Timer Set Up group allows you to configure a time-out period and to select the timer start by either the keyboard (**RUN/HOLD** key) or Alarm 2. The optional digital input can also be configured to the start the timer. The timer display is selectable as either “time remaining” (see *TREM*) or “elapsed time” (see *ET*).

Alarm 1 is activated at the end of the time-out period. When the timer is enabled, it has exclusive control of the alarm 1 relay—any previous alarm 1 configuration is ignored. At time-out, the timer is ready to be activated again by whatever action has been configured.

### Function Prompts

**Table 4-3 TIMER Group (Numeric Code 100) Function Prompts**

Prompt		Description	Selection or Range of Setting		Factory Setting	Reference Guide Page
English	Numeric Code		Numeric Code	English		
<b>TIMER</b>	<b>101</b>	Enable or Disable Timer	0 1	DIS ENAB	DIS	156
<b>PERIOD</b>	<b>102</b>	Time-out Period		0:00 to 99:59 Select length of time in Hours and Minutes, or minutes and seconds.	0:01	145
<b>START</b>	<b>103</b>	Timer Function Start	0 1	KEY (RUN/HOLD key) AL2 (Alarm 2)	KEY	155
<b>L DISP</b>	<b>104</b>	Timer Display	0 1	TREM (time remaining) ET (elapsed time)	TREM	140
<b>RESET</b>	<b>105</b>	Timer Reset Control	0 1	Key (Run/Hold key) AL1 (Alarm 1 or Key)	KEY	156
<b>INCRMT</b>	<b>106</b>	Timer Count Increment	0 1	MIN (Counts HR/MIN) SEC (Counts MIN/SEC)	MIN	136

## 4.5 Tuning Set Up Group

### Introduction

Tuning consists of establishing the appropriate values for the tuning constants you are using so that your controller responds correctly to changes in process variable and setpoint. You can start with predetermined values but you will have to watch the system to see how to modify them. The Accutune feature automatically selects Gain, Rate, and Reset on demand.

#### ATTENTION

Because this group contains functions that have to do with security and lockout, we recommend that you configure this group last, after all other configuration data has been loaded.

### Function Prompts

**Table 4-4 TUNING Group (Numeric Code 200) Function Prompts**

Prompt		Description	Selection or Range of Setting		Factory Setting	Reference Guide Page
English	Numeric Code		Numeric Code	English		
<b>PB or GAIN</b>	<b>201</b>	Proportional Band or Gain		PB = 0.1 to 1000 % Gain = 0.01 to 1000	1.0	143
<b>RATE T</b>	<b>202</b>	Rate in Minutes		0.00 to 10.00 minutes 0.08 or less = OFF	0.00	148
<b>I MIN</b> or <b>I RPM</b>	<b>203</b>	Reset in minutes/repeat Reset in repeats/minute		0.02 to 50.00 0.02 to 50.00	1.0 1.0	136
<b>MANRST</b>	<b>204</b>	Manual Reset		-100 to 100 % Output	0.0	142
<b>PB 2 or GAIN 2</b>	<b>205</b>	Proportional Band 2 or Gain 2		PB = 0.1 to 1000 % Gain = 0.01 to 1000	1.0	144
<b>RATE2T</b>	<b>206</b>	Rate 2 in Minutes		0.00 to 10.00 minutes 0.08 or less = OFF	0.00	148
<b>I2 MIN</b> or <b>I2 RPM</b>	<b>207</b>	Reset in minutes/repeat Reset in repeats/minute		0.02 to 50.00 0.02 to 50.00	1.0 1.0	136

*Table continued next page*

**Table 4-4 TUNING Group (Numeric Code 200) Function Prompts, continued**

Prompt		Description	Selection or Range of Setting		Factory Setting	Reference Guide Page
English	Numeric Code		Numeric Code	English		
<b>CYC T1 or CT1X3</b>	<b>208</b>	Cycle Time (Heat)		1 to 120 <i>Cycle times are in either second or 1/3-second increments depending upon the configuration of RLY TYP in the "Algorithm" Set Up group.</i>	20	129
<b>CYC2T2 or CT2 X3</b>	<b>209</b>	Cycle Time (Cool)		1 to 120 <i>Cycle times are in either second or 1/3-second increments depending upon the configuration of RLY TYP in the "Algorithm" Set Up group.</i>	20	130
<b>SECUR</b>	<b>210</b>	Security Code		0 to 4095	0	151
<b>LOCK</b>	<b>211</b>	Lockout	0 1 2 3 4	NONE CAL CONF VIEW ALL	CAL	141
<b>AUTOMA</b>	<b>212</b>	Auto/Manual Key Lockout	0 1	DIS ENAB	ENAB	121
<b>A TUNE</b>	<b>213</b>	Autotune Key Lockout	0 1	DIS ENAB	ENAB	120
<b>RN HLD</b>	<b>214</b>	Run/Hold Key Lockout	0 1	DIS ENAB	ENAB	150
<b>SP SEL</b>	<b>215</b>	Setpoint Select Function Lockout	0 1	DIS ENAB	ENAB	155



## 4.6 SP Ramp Set Up Group

### Introduction

A *single setpoint ramp* [SPRAMP] can be configured to occur between the current local setpoint and a final local setpoint over a time interval of from 1 to 255 minutes.

SPRATE lets you configure a *specific rate of change* for any local setpoint change.

You can also configure a 12-segment program from a *Ramp/Soak profile*.

You can start and stop the ramp/program using the **RUN/HOLD** key.

*PV Hot Start* is standard and means that at power up, the setpoint is set to the current PV value and the Ramp or Rate or Program then starts from this value.

### Function Prompts

**Table 4-5 SPRAMP Group (Numeric Code 300) Function Prompts**

Prompt		Description	Selection or Range of Setting		Factory Setting	Reference Guide Page
English	Numeric Code		Numeric Code	English		
<b>SP RAMP</b>	<b>301</b>	Single Setpoint Ramp	0	DIS	DIS	154
			1	ENAB <i>Rate and Program must be disabled</i>		
<b>TI MIN</b>	<b>302</b>	Single Setpoint Ramp Time		0 to 255 minutes	3	156
<b>FINLSP</b>	<b>303</b>	Setpoint Ramp Final Setpoint		Enter a value within the setpoint limits	1000	134
<b>SPRATE</b>	<b>304</b>	Setpoint Rate	0	DIS	DIS	154
			1	ENAB <i>Ramp and Program must be disabled</i>		
<b>EUHRUP</b>	<b>305</b>	Rate Up		0 to 9999 in Engineering units per hour	0	133
<b>EUHRDN</b>	<b>306</b>	Rate Down		0 to 9999 in Engineering units per hour	0	133
<b>SPPROG</b>	<b>307</b>	Setpoint Ramp/Soak Programming	0	DIS	DIS	154
			1	ENAB <i>Rate and Ramp must be disabled</i>		
<b>STRSEG</b>	<b>308</b>	Start Segment Number		1 to 11	- - -	156
<b>ENDSEG</b>	<b>309</b>	End Segment Number		2 to 12 (always end in a soak segment 2, 4, ... 12)	- - -	133
			2	SOK 2		
			4	SOK 4		
			6	SOK 6		
			8	SOK 8		
			10	SOK 10		
			12	SOK 12		

**Table 4-5 SPRAMP Group (Numeric Code 300) Function Prompts, continued**

Prompt		Description	Selection or Range of Setting		Factory Setting	Reference Guide Page
English	Numeric Code		Numeric Code	English		
<b>RPUNIT</b>	<b>310</b>	Engineering units for Ramp Segments	0	TIME (hours:minutes)	TIME	150
			1	EU-M (Rate EU/Minute)		
			2	EU-H (Rate EU/Hour)		
<b>RECYCL</b>	<b>311</b>	Number of Program Recycles		0 to 99 recycles	---	149
<b>SOKDEV</b>	<b>312</b>	Guaranteed Soak Deviation Value		0 to 99 0 = No Soak	---	152
<b>PG END</b>	<b>313</b>	Program Termination State	0	LAST (Hold at last SP)	---	145
			1	FSAF (Manual mode/failsafe)		
<b>STATE</b>	<b>314</b>	Program State at Program End	0	DIS	DIS	155
			1	HOLD		
<b>ToBEGN</b>	<b>315</b>	Reset Program to the Beginning	0	DIS	DIS	156
			1	KEY (Keyboard)		
<b>PVSTRT</b>	<b>316</b>	Program starts at PV value	0	DIS	DIS	
			1	ENAB		
<b>SGx RP</b>		Segment Ramp or Rate Time x = 1 through 11		0-99hours:0-59minutes	---	151
<b>SG1</b>	<b>317</b>			Engineering Units/minute		
<b>SG3</b>	<b>320</b>			or		
<b>SG5</b>	<b>323</b>			Engineering Units /hour		
<b>SG7</b>	<b>326</b>					
<b>SG9</b>	<b>329</b>					
<b>SG11</b>	<b>332</b>					
<b>SGx SP</b>		Segment Soak Setpoint Value x = 2 through 12		Enter a Value within the Setpoint Limits	---	151
<b>SG2</b>	<b>318</b>					
<b>SG4</b>	<b>321</b>					
<b>SG6</b>	<b>324</b>					
<b>SG8</b>	<b>327</b>					
<b>SG10</b>	<b>330</b>					
<b>SGx TI</b>		Segment Soak Duration x = 2 through 12		0-99 Hours:0-59 Minutes	---	152
<b>SG2</b>	<b>319</b>					
<b>SG4</b>	<b>322</b>					
<b>SG6</b>	<b>325</b>					
<b>SG8</b>	<b>328</b>					
<b>SG10</b>	<b>331</b>					
<b>SG12</b>	<b>334</b>					

## 4.7 Accutune Set Up Group

### Introduction

*Accutune II* automatically calculates GAIN, RATE, and RESET TIME (PID) tuning constants for your control loop. When initiated on demand, the Accutune algorithm measures a process step response and automatically generates the PID tuning constants needed for no overshoot on your process.

*Fuzzy Overshoot Suppression*, when enabled, will suppress or eliminate any overshoot that may occur as a result of the existing tuning parameters, as the PV approaches the setpoint.

### Function Prompts

**Table 4-6 ATUNE Group (Numeric Code 400) Function Prompts**

Prompt		Description	Selection or Range of Setting		Factory Setting	Reference Guide Page
English	Numeric Code		Numeric Code	English		
<b>FUZZY</b>	<b>401</b>	Fuzzy Overshoot Suppression	0	DIS	DIS	135
			1	ENAB		
<b>TUNE</b>	<b>402</b>	Demand Tuning	0	DIS	TUNE	157
			1	TUNE		
<b>AT ERR</b>	<b>403</b>	Accutune Error Codes (Read Only)	0	NONE	---	121
			3	IDFL		
			4	ABRT		
			5	RUN		

## 4.8 Algorithm Set Up Group

### Introduction

This data deals with various algorithms in the controller: Control algorithm, Output algorithm, Current Duplex Range, and Relay Cycle Time Increment.

### Function Prompts

**Table 4-7 ALGOR Group (Numeric Code 500) Function Prompts**

Prompt		Description	Selection or Range of Setting		Factory Setting	Reference Guide Page
English	Numeric Code		Numeric Code	English		
<b>CTRALG</b>	<b>501</b>	Control Algorithm	0	ONOF	PIDA	127
			1	PIDA		
			2	PIDB		
			3	PDMR		
			4	TPSC (3 position step)		
<b>OUTALG</b>	<b>502</b>	Output Algorithm	0	RLY (Time simplex Relay 1)	depends on model	142
			1	RLY2 (Time simplex Relay 2)		
			2	CUR (Current simplex)		
			3	TPSC (3 Position step)		
			4	RLYD (Time duplex)		
			5	CURD (Current duplex)		
			6	CURT (Current/time duplex)		
			7	TCUR (Time/current duplex)		
<b>4-20RG</b>	<b>503</b>	Current Duplex Range	0	100 (Full)	100	119
			1	50 (Split)		
<b>RLY TYP</b>	<b>504</b>	Relay Cycle Time Increment	0	MECH (one sec. increments)	MECH	149
			1	S S (1/3 sec increments)		

## 4.9 Input 1 Set Up Group

### Introduction

This data deals with various parameters required to configure Input 1.

### Function Prompts

**Table 4-8 INPUT1 Group (Numeric Code 600) Function Prompts**

Prompt		Description	Selection or Range of Setting		Factory Setting	Reference Guide Page																																																																				
English	Numeric Code		Numeric Code	English																																																																						
<b>DECIMAL</b>	<b>601</b>	Decimal Point Selection	0	8888 (none)	8888	131																																																																				
			1	888.8																																																																						
			2	88.88																																																																						
<b>UNITS</b>	<b>602</b>	Temperature Units	1	F	F	157																																																																				
			2	C																																																																						
			0	NONE																																																																						
<b>IN1TYP</b>	<b>603</b>	Input 1 Actuation Type	<table border="1"> <thead> <tr> <th>Numeric</th> <th>English</th> <th>Numeric</th> <th>English</th> </tr> </thead> <tbody> <tr><td>1</td><td>B</td><td>17</td><td>W H</td></tr> <tr><td>2</td><td>E H</td><td>18</td><td>W L</td></tr> <tr><td>3</td><td>E L</td><td>19</td><td>100H</td></tr> <tr><td>4</td><td>J H</td><td>20</td><td>100L</td></tr> <tr><td>5</td><td>J L</td><td>21</td><td>200</td></tr> <tr><td>6</td><td>K H</td><td>22</td><td>500</td></tr> <tr><td>7</td><td>K L</td><td>23</td><td>RADH</td></tr> <tr><td>8</td><td>NNMH</td><td>24</td><td>RADI</td></tr> <tr><td>9</td><td>NNML</td><td>25</td><td>0-20</td></tr> <tr><td>10</td><td>N90H</td><td>26</td><td>4-20</td></tr> <tr><td>11</td><td>N90L</td><td>27</td><td>10m</td></tr> <tr><td>12</td><td>NIC</td><td>28</td><td>50m</td></tr> <tr><td>13</td><td>R</td><td>29</td><td>0-5</td></tr> <tr><td>14</td><td>S</td><td>30</td><td>1-5</td></tr> <tr><td>15</td><td>T H</td><td>31</td><td>0-10</td></tr> <tr><td>16</td><td>T L</td><td>33</td><td>100m</td></tr> </tbody> </table>		Numeric	English	Numeric	English	1	B	17	W H	2	E H	18	W L	3	E L	19	100H	4	J H	20	100L	5	J L	21	200	6	K H	22	500	7	K L	23	RADH	8	NNMH	24	RADI	9	NNML	25	0-20	10	N90H	26	4-20	11	N90L	27	10m	12	NIC	28	50m	13	R	29	0-5	14	S	30	1-5	15	T H	31	0-10	16	T L	33	100m	K H	138
			Numeric	English	Numeric	English																																																																				
			1	B	17	W H																																																																				
			2	E H	18	W L																																																																				
			3	E L	19	100H																																																																				
			4	J H	20	100L																																																																				
			5	J L	21	200																																																																				
			6	K H	22	500																																																																				
			7	K L	23	RADH																																																																				
			8	NNMH	24	RADI																																																																				
			9	NNML	25	0-20																																																																				
			10	N90H	26	4-20																																																																				
			11	N90L	27	10m																																																																				
			12	NIC	28	50m																																																																				
			13	R	29	0-5																																																																				
			14	S	30	1-5																																																																				
			15	T H	31	0-10																																																																				
16	T L	33	100m																																																																							
<b>XMITR1</b>	<b>604</b>	Transmitter Characterization	0	B	13	S	LIN	158																																																																		
			1	E H	14	T H																																																																				
			2	E L	15	T L																																																																				
			3	J H	16	W H																																																																				
			4	J L	17	W L																																																																				
			5	K H	18	100H																																																																				
			6	K L	19	100L																																																																				
			7	NNMH	20	200																																																																				
			8	NNML	21	500																																																																				
			9	N90H	22	RADH																																																																				
			10	N90L	23	RADI																																																																				
			11	NIC	24	LIN																																																																				
			12	R	25	SrT																																																																				

**Table 4-8 INPUT1 Group (Numeric Code 600) Function Prompts, continued**

Prompt		Description	Selection or Range of Setting		Factory Setting	Reference Guide Page
English	Numeric Code		Numeric Code	English		
<b>IN1 HI</b>	<b>605</b>	Input 1 High Range Value		–999 to 9999 floating in engineering units	2400	136
<b>IN1 LO</b>	<b>606</b>	Input 1 Low Range Value		–999 to 9999 floating in engineering units	0	137
<b>RATIO1</b>	<b>607</b>	Ratio on Input 1		-20.0 to 20.0	1.00	149
<b>BIAS 1</b>	<b>608</b>	Bias on Input 1		-999 to 9999	0.0	125
<b>FILTR1</b>	<b>609</b>	Filter for Input 1		0 to 120 seconds 0 = No Filter	1.0	134
<b>BRNOUT</b>	<b>610</b>	Burnout Protection (Sensor Break)	0 1 2 3	NONE UP (Upscale) DOWN (Downscale) NOFS (No Failsafe)	UP	126
<b>EMISS</b>	<b>611</b>	Emissivity		0.01 to 1.00 (RADH & RADI only)	1.0	133
<b>FREQ</b>	<b>612</b>	Power Line Frequency	0 1	60 50	60	135
<b>DISPLY</b>	<b>613</b>	Default Display (Single Display models only)	0 1 2	SP (Setpoint) PRY ( PV with Label) PRN (PV without Label)	PRN	—
<b>LNGUAG</b>	<b>614</b>	Language Selection	0 1 2 3 4 5	ENGL FREN GERM SPAN ITAL NUMB (Numeric)	ENGL	140

## 4.10 Input 2 Set Up Group

### Introduction

This data deals with various parameters required to configure Input 2.

### Function Prompts

**Table 4-9 INPUT2 Group (Numeric Code 700) Function Prompts**

Prompt		Description	Selection or Range of Setting		Factory Setting	Reference Guide Page																																																								
English	Numeric Code		Numeric Code	English																																																										
<b>IN2TYP</b>	<b>701</b>	Input 2 Type	0	DIS	1-5V	140																																																								
			25	0-20 (mA)																																																										
			26	4-20 (mA)																																																										
			29	0-5 (Volts)																																																										
			30	1-5 (Volts)																																																										
			34	0-2 (Volts)																																																										
<b>XMTR2</b>	<b>702</b>	Transmitter Characterization for Input 2	<table border="1"> <thead> <tr> <th>Numeric</th> <th>English</th> <th>Numeric</th> <th>English</th> </tr> </thead> <tbody> <tr> <td>0</td> <td>B</td> <td>13</td> <td>S</td> </tr> <tr> <td>1</td> <td>E H</td> <td>14</td> <td>T H</td> </tr> <tr> <td>2</td> <td>E L</td> <td>15</td> <td>T L</td> </tr> <tr> <td>3</td> <td>J H</td> <td>16</td> <td>W H</td> </tr> <tr> <td>4</td> <td>J L</td> <td>17</td> <td>W L</td> </tr> <tr> <td>5</td> <td>K H</td> <td>18</td> <td>100H</td> </tr> <tr> <td>6</td> <td>K L</td> <td>19</td> <td>100L</td> </tr> <tr> <td>7</td> <td>NNMH</td> <td>20</td> <td>200</td> </tr> <tr> <td>8</td> <td>NNML</td> <td>21</td> <td>500</td> </tr> <tr> <td>9</td> <td>N90H</td> <td>22</td> <td>RADH</td> </tr> <tr> <td>10</td> <td>N90L</td> <td>23</td> <td>RADI</td> </tr> <tr> <td>11</td> <td>NIC</td> <td>24</td> <td>LIN</td> </tr> <tr> <td>12</td> <td>R</td> <td>25</td> <td>SrT</td> </tr> </tbody> </table>		Numeric	English	Numeric	English	0	B	13	S	1	E H	14	T H	2	E L	15	T L	3	J H	16	W H	4	J L	17	W L	5	K H	18	100H	6	K L	19	100L	7	NNMH	20	200	8	NNML	21	500	9	N90H	22	RADH	10	N90L	23	RADI	11	NIC	24	LIN	12	R	25	SrT	LIN	159
			Numeric	English	Numeric	English																																																								
			0	B	13	S																																																								
			1	E H	14	T H																																																								
			2	E L	15	T L																																																								
			3	J H	16	W H																																																								
			4	J L	17	W L																																																								
			5	K H	18	100H																																																								
			6	K L	19	100L																																																								
			7	NNMH	20	200																																																								
			8	NNML	21	500																																																								
			9	N90H	22	RADH																																																								
			10	N90L	23	RADI																																																								
			11	NIC	24	LIN																																																								
12	R	25	SrT																																																											
<table border="1"> <thead> <tr> <th>Numeric</th> <th>English</th> </tr> </thead> </table>		Numeric	English																																																											
Numeric	English																																																													
<b>IN2 HI</b>	<b>703</b>	Input 2 High Range Value	-999 to 9999 floating in engineering units	2400	139																																																									
<b>IN2 LO</b>	<b>704</b>	Input 2 Low Range Value	-999 to 9999 floating in engineering units	0	139																																																									
<b>RATIO2</b>	<b>705</b>	Ratio on Input 2	-20.0 to 20.0	1.00	149																																																									
<b>BIAS 2</b>	<b>706</b>	Bias on Input 2	-999 to 9999	0.0	125																																																									
<b>FILTR2</b>	<b>707</b>	Filter for Input 2	0 to 120 seconds 0 = No Filter	1.0	134																																																									

## 4.11 Control Set Up Group

### Introduction

The functions listed in this group deal with how the controller will control the process including: Number of Tuning Parameter Sets, Setpoint Source, Tracking, Power-up Recall, Setpoint Limits, Output Direction and Limits, Deadband, and Hysteresis.

### Function Prompts

**Table 4-10 CONTRL Group (Numeric Code 800) Function Prompts**

Prompt		Description	Selection or Range of Setting		Factory Setting	Reference Guide Page
English	Numeric Code		Numeric Code	English		
<b>PIDSET</b>	<b>801</b>	Number of Tuning Parameter Sets	0	ONE	ONE	146
			1	2KBD (Keyboard)		
			2	2 PR (PV switch)		
			3	2 SP (SP switch)		
<b>SW VAL</b>	<b>802</b>	Automatic Switchover Value		Value in engineering units within PV or SP range limits	0.00	156
<b>LSP'S</b>	<b>803</b>	Local Setpoint Source	0	ONE	ONE	141
			1	TWO		
<b>RSPSRC</b>	<b>804</b>	Remote Setpoint Source	0	NONE	NONE	150
			1	INP2		
<b>SP TRK</b>	<b>805</b>	Setpoint Tracking	0	NONE	NONE	155
			1	PROC (LSP tracks PV–manual)		
			2	RSP (LSP tracks RSP–auto)		
<b>PWR UP</b>	<b>806</b>	Power Up Controller Mode Recall	0	MAN (Manual/LSP/failsafe)	ALSP	148
			1	ALSP (Auto/last LSP)		
			2	ARSP (Auto/last RSP)		
			3	AMSP (Last mode/last SP)		
			4	AMLS (Last mode/last LSP)		
<b>PWROUT</b>	<b>807</b>	TPSC (Three Position Step Control) Output Start-up Mode	0	LAST (Last output)	LAST	147
			1	FSAF (Failsafe output)		
<b>SP Hi</b>	<b>808</b>	Setpoint High Limit		0 to 100 % of the PV range	2400	153
<b>SP Lo</b>	<b>809</b>	Setpoint Low Limit		0 to 100 % of the PV range	0	153
<b>ACTION</b>	<b>810</b>	Control Output Direction	0	DIR	REV	120
			1	REV		



Table 4-10 CONTRL Group (Numeric Code 800) Function Prompts, continued

Prompt		Description	Selection or Range of Setting		Factory Setting	Reference Guide Page
English	Numeric Code		Numeric Code	English		
OUT Hi	811	High Output Limit		-5 to 105 % of Output (Current)	100	143
				0.0 to 100.0 % of Output (Relay)		
OUT Lo	812	Low Output Limit		-5 to 105 % of Output (Current)	0	143
				0.0 to 100.0 % of Output (Relay)		
D BAND	813	Deadband		-5 to 25.0 % (Time Duplex)	2.0	130
				0.5 to 5.0 % (3 position step)		
HYST	814	Hysteresis (Output Relay Only)		0.0 to 100.0 % of PV	0.5	135
FAILSF	815	Failsafe Output Value		0 to 100 %	0.0	134
				<b>For 3 Position Step</b>		
				0 (Closed position) 100 (Open position)		
FSMODE	817	Failsafe Mode	0	No L (Mode does not clear once unit goes to FS Output)	NO_L	135
			1	LACH (Unit goes to manual and FS output)		
PBoGN	818	Proportional Band Units	0	GAIN	GAIN	145
			1	PB		
MINRPM	819	Reset Units	0	MIN	MIN	142
			1	RPM		

## 4.12 Options Set Up Group

### Introduction

The Options group lets you configure the remote mode switch (Digital Inputs) to a specific contact closure response, or configure the Auxiliary Output to be a specific selection with desired scaling.

### Function Prompts

**Table 4-11 Options Group (Numeric Code 900) Function Prompts**

Prompt		Description	Selection or Range of Setting			Factory Setting	Reference Guide Page
English	Numeric Code		Numeric Code	English			
<b>AUXOUT</b>	<b>901</b>	Auxiliary Output	0	DIS	Disabled	DIS	122
			1	IN1	Input 1		
			2	IN2	Input 2		
			3	PROC	Process Variable		
			4	DEV	Deviation		
			5	OUT	Output		
			6	SP	Setpoint		
			7	LSP1	Local Setpoint 1		
<b>0 PCT</b>	<b>902</b>	Auxiliary Output Low Scaling Factor		Value in Engineering Units		0	119
<b>100 PCT</b>	<b>903</b>	Auxiliary Output High Scaling Factor		Value in Engineering Units		100	119
<b>DIG IN</b>	<b>904</b>	Digital Input	0	None		NONE	131
			1	MAN	To Manual		
			2	LSP	To Local SP 1		
			3	SP2	To Local SP 2		
			4	DIR	Direct Control		
			5	HOLD	Hold SPP/SP Ramp		
			6	PID2	PID Set 2		
			7	RUN	Start a stopped SPP/SP Ramp		
			8	Begn	SPP Reset		
			9	NO I	Inhibit Integral		
			10	MNFS	Manual, Failsafe Output		
			11	LOCK	Keyboard Disable		
			12	TIMR	Start Timer		
			13	TUNE	Start Tune		
			14	INIT	Init SP to PV		
			15	RSP	Remote SP		
			16	MNLT	Latching Manual		
17	TRAK	Output tracks Input 2					
<b>DI COM</b>	<b>905</b>	Digital Input Combinations	0	DIS	Disable	DIS	131
			1	+ PD2	PID Set 2		
			2	+DIR	Direct		
			3	+SP2	Set Point 2		
			4	+SP1	Set Point 1		
			5	+RUN	Start SPP		

## 4.13 Communications Set Up Group

### Introduction

The Communications group lets you configure the controller to be connected to a host computer via RS422/486 or Modbus® protocol.

### Function Prompts

**Table 4-12 Communications Group (Numeric Code 1000)**

Prompt		Description	Selection or Range of Setting		Factory Setting	Reference Guide Page	
English	Numeric Code		Numeric Code	English			
<b>COMSTA</b>	<b>1001</b>	Communications State	0	DIS Disable	DIS	—	
			1	R422 RS-422/485			
			2	MODB Modbus			
<b>ComADD</b>	<b>1002</b>	Station Address		1 to 99	0		
<b>SDENAB</b>	<b>1003</b>	Disable/Enable Shed function	0	DIS Disable	ENAB		
			1	ENAB Enable			
				Note: If Control Algorithm is 3 Position Step Control then this must be enabled.			
<b>SHDTIM</b>	<b>1004</b>	Shed Time		0 to 255 Sample Periods	0		
<b>PARITY</b>	<b>1005</b>	Parity	0	Odd	Odd		
			1	Even			
<b>BAUD</b>	<b>1006</b>	Baud Rate	0	2400 Baud	2400		
			1	4800 Baud			
			2	9600 Baud			
			3	19200 Baud			
<b>TX_DLY</b>	<b>1007</b>	Response Delay		1 to 500 milliseconds	1		
<b>WS_FLT</b>	<b>1008</b>	Word/Byte Order for floating point communications data		<u>Byte</u>	<u>Contents</u>	FP_B	
			0		seeeeeee		
			1		emmmmmm		
			2		mmmmmmm		
			3		mmmmmmm		
				<u>Choice</u>	<u>Byte Order</u>		
			0	FP_B	0123		
1	FPBB	1032					
2	FP_L	3210					
3	FPLB	2301					

**Table 4-12 Communications Group (Numeric Code 1000) (continued)**

Prompt		Description	Selection or Range of Setting		Factory Setting	Reference Guide Page
English	Numeric Code		Numeric Code	English		
<b>SDMODE</b>	<b>1009</b>	Shed Output Mode	0	LAST Same Mode & Output	LAST	
			1	MAN_Manual Mode, Same Output		
			2	FSAF Man Mode, Failsafe Output		
			3	AUTOAuto Mode, Failsafe Output		
<b>SHD_SP</b>	<b>1010</b>	Shed Setpoint Recall	0	LSP Last Local or remote used	LSP	
			1	CSP last Computer Setpoint		
<b>UNITS</b>	<b>1011</b>	Communications Override Units	0	PCT Percent	PCT	
			1	Eng Engineering Units		
<b>CSRATIO</b>	<b>1012</b>	Computer Setpoint Ratio		-20.0 to 20.0	1.0	
<b>CSP_BI</b>	<b>1013</b>	Computer Setpoint Bias		-999 to 9999 in Engineering Units	0	
<b>LOOPBK</b>	<b>1014</b>	Local Loopback Test	0	DIS Disable	DIS	
			1	EnAB Enable		

## 4.14 Alarms Set Up Group

### Introduction

An alarm is an indication that an event that you have configured (for example—Process Variable) has exceeded one or more alarm limits. There are two alarms available. Each alarm has two setpoints. You can configure each of these two setpoints to alarm on various controller parameters.

There are two alarm output selections, High and Low. You can configure each setpoint to alarm either High or Low. These are called single alarms.

You can also configure the two setpoints to alarm on the same event and to alarm both high and low. A single adjustable Hysteresis of 0 % to 100 % is configurable for the alarm setpoint.

See *Table 2-4 in the Installation section* for Alarm relay contact information.

The prompts for the Alarm Outputs appear whether or not the alarm relays are physically present. This allows the Alarm status to be shown on the display and/or sent via communications to a host computer.

### Function Prompts

**Table 4-13 ALARMS Group (Numeric Code 1100) Function Prompts**

Prompt		Description	Selection or Range of Setting			Factory Setting	Reference Guide Page
English	Numeric Code		Numeric Code	English			
<b>AxSxVA</b>		Alarm Setpointx Value X = 1 or 2	within the range of the selected parameter or of the PV Span for Deviation configurations			90	125
<b>A1S1</b>	<b>1101</b>						
<b>A1S2</b>	<b>1102</b>						
<b>A2S1</b>	<b>1103</b>						
<b>A2S2</b>	<b>1104</b>						
<b>AxSxTY</b>		Alarmx Setpointx Type X = 1 or 2	0	NONE	No Alarm	NONE	124
<b>A1S1</b>	<b>1105</b>		1	IN 1	Input 1		
<b>A1S2</b>	<b>1106</b>		2	IN 2	Input 2		
<b>A2S1</b>	<b>1107</b>		3	PROC	Process Variable		
<b>A2S2</b>	<b>1108</b>		4	DE	Deviation		
			5	OUT	Output		
			6	SHED	ShedCommunications		
			7	E-ON	Event ON(SP Prog)		
			8	E-OFF	Event OFF(SP Prog)		
			9	MAN	Alarm on Manual		
			10	RSP	Remote Setpoint		
			11	FSAF	Failsafe		
			12	PrRT	PV Rate of Change		
			13	DI	Alarm on Digital Input		
			14	DE 11	DEV Alarm based on SP2		
		15	BRAK	Loop break alarm			

**Table 4-13 ALARMS Group (Numeric Code 1100) Function Prompts, continued**

Prompt		Description	Selection or Range of Setting			Factory Setting	Reference Guide Page
English	Numeric Code		Numeric Code	English			
<b>AxSxHL</b>		Alarmx Setpoint	0	LOW	Low Alarm	HIGH	123
<b>A1S1</b>	<b>1109</b>	State	1	HIGH	High Alarm		
<b>A1S2</b>	<b>1110</b>	X = 1 or 2					
<b>A2S1</b>	<b>1111</b>						
<b>A2S2</b>	<b>1112</b>						
<b>AxSxEV</b>		Alarmx Segment	0	BEGN	Beginning of	BEGN	123
<b>A1S1</b>	<b>1109</b>	Event x		Segment			
<b>A1S2</b>	<b>1110</b>	X = 1 or 2	1	END	End of Segment		
<b>A2S1</b>	<b>1111</b>						
<b>A2S2</b>	<b>1112</b>						
<b>ALHYST</b>	<b>1113</b>	Alarm Hysteresis		0.0 to 100.0 % of span or full output as appropriate		0.0	121
<b>ALARM1</b>	<b>1114</b>	Latching Alarm Output	0	NO L		NO L	120
			1	LACH			
<b>BLOCK</b>	<b>1115</b>	Alarm Blocking	0	DIS	Disable Blocking	DIS	126
			1	BK1	Block Alarm 1		
			2	BK2	Block Alarm 2		
			3	BK12	Blocks both Alarms		

### 4.15 Configuration Record Sheet

Enter the value or selection for each prompt on this sheet so you will have a record of how your controller was configured.

Group Prompt	Function Prompt	Value or Selection	Factory Setting	Group Prompt	Function Prompt	Value or Selection	Factory Setting
<b>TIMER</b>	TIMER	_____	DIS	<b>ATUNE</b>	FUZZY	_____	DIS
	PERIOD	_____	0:01		TUNE	_____	TUNE
	START	_____	KEY		AT ERR	_____	---
	L DISP	_____	TREM				
	RESET	_____	KEY				
INCRMT	_____	MIN					
<b>TUNING</b>	PB or GAIN	_____	1.0	<b>ALGOR</b>	CTRALG	_____	PIDA
	RATE T	_____	0.00		OUTALG	_____	(MOXL)
	I MIN or I RPM	_____	1.0		4-20RG	_____	100
	MANRST	_____	1.0		RLY TY	_____	127
	PB2 or GAIN 2	_____	0.0				
	RATE2T	_____	0.00				
	I2 MIN or I2 RPM	_____	1.0				
	CYCT1 or CT1	_____	20				
	X3	_____	20				
	CYC2T2 or CT2	_____	20				
	X3	_____	20				
	SECUR	_____	0				
	LOCK	_____	CAL				
	AUTOMA	_____	ENAB				
	A TUNE	_____	ENAB				
RN HLD	_____	ENAB					
SP SEL	_____	ENAB					
<b>SPRAMP</b>	SPRAMP	_____	DIS	<b>INPUT1</b>	DECIMAL	_____	8888
	ATI MIN	_____	3		UNITS	_____	DegF
	FINLSP	_____	1000		IN1TYP	_____	KH
	SPRATE	_____	DIS		XMITR1	_____	LIN
	EUHRUP	_____	0		IN1 HI	_____	2400
	EUHRDN	_____	0		IN1 LO	_____	0
	SPPROG	_____	DIS		RATIO1	_____	1.00
					BIAS 1	_____	0.0
					RILTR1	_____	1.0
					BRNOUT	_____	UP
					EMIS	_____	1.0
					FREQ	_____	60
			DISPLY	_____	SP		
			LNGUAG	_____	ENGL		

*Configuration Record Sheet continued on next page*

Group Prompt	Function Prompt	Value or Selection	Factory Setting	Group Prompt	Function Prompt	Value or Selection	Factory Setting
<b>INPUT2</b>	IN2TYP	_____	1-5V	<b>COM</b>	ComSTA	_____	Disable
	LIN	_____	LIN		ComADD	_____	0
	IN2 HI	_____	2400		SDENAB	_____	Enable
	IN2 LO	_____	0		SHDTIM	_____	0
	RATIO2	_____	1.00		PARITY	_____	Odd
	BIAS 2	_____	0.0		BAUD	_____	9600
	FILTR2	_____	1.0		TX_DLY	_____	1
					WS_FLT	_____	FP_B
			SDMODE	_____	Last		
			SHDSP	_____	LSP		
			UNITS	_____	PCT		
			CSRATO	_____	1.0		
			CSP_BI	_____	0		
			LOOPBACK	_____	Disable		
<b>CONTRL</b>	PIDSET	_____	ONE	<b>ALARMS</b>	A1S1VA	_____	90
	SW VAL	_____	0.00		A1S2VA	_____	90
	LSP'S	_____	ONE		A2S1VA	_____	90
	RSPSRC	_____	NONE		A2S2VA	_____	90
	SP TRK	_____	NONE		A1S1TY	_____	NONE
	PWR UP	_____	MAN		A1S1TY	_____	NONE
	PWROUT	_____	LAST		A2S1TY	_____	NONE
	SP Hi	_____	2400		A2S2TY	_____	NONE
	SP Lo	_____	0		A1S1HL	_____	HIGH
	ACTION	_____	REV		A1S1EV	_____	BEGN
	OUT Hi	_____	100		A1S2HL	_____	HIGH
	OUT Lo	_____	0		A1S2EV	_____	BEGN
	D BAND	_____	2.0		A2S1HL	_____	HIGH
	HYST	_____	0.5		A2S1EV	_____	BEGN
	FAILSF	_____	0.0		A2S2HL	_____	HIGH
	FSMODE	_____	NOL		A2S2EV	_____	BEGN
	PBorGN	_____	GAIN		ALHYST	_____	0.0
	MINRPM	_____	MIN		ALARM1	_____	NOL
			BLOCK	_____	DIS		
<b>OPTIONS</b>	AUXOUT	_____	DIS				
	0 PCT	_____	0				
	100 PCT	_____	100				
	DIG IN	_____	NONE				
	DIG COM	_____	DIS				



---

## 5 Monitoring the Controller

### 5.1 Overview

#### Introduction

This section gives you all the information necessary to help you monitor your controller including an Operator Interface overview, how to lockout changes to the controller, entering a security code, and monitoring the displays.

#### What's in this section?

The following topics are covered in this section.

TOPIC	See Page
5.2 Operator Interface	46
5.3 Entering A Security Code	46
5.4 Lockout Feature	47
5.5 Monitoring The Controller	49

## 5.2 Operator Interface

### Introduction

Figure 5-1 is a view of the Operator Interface. A description of the displays and indicators is included.

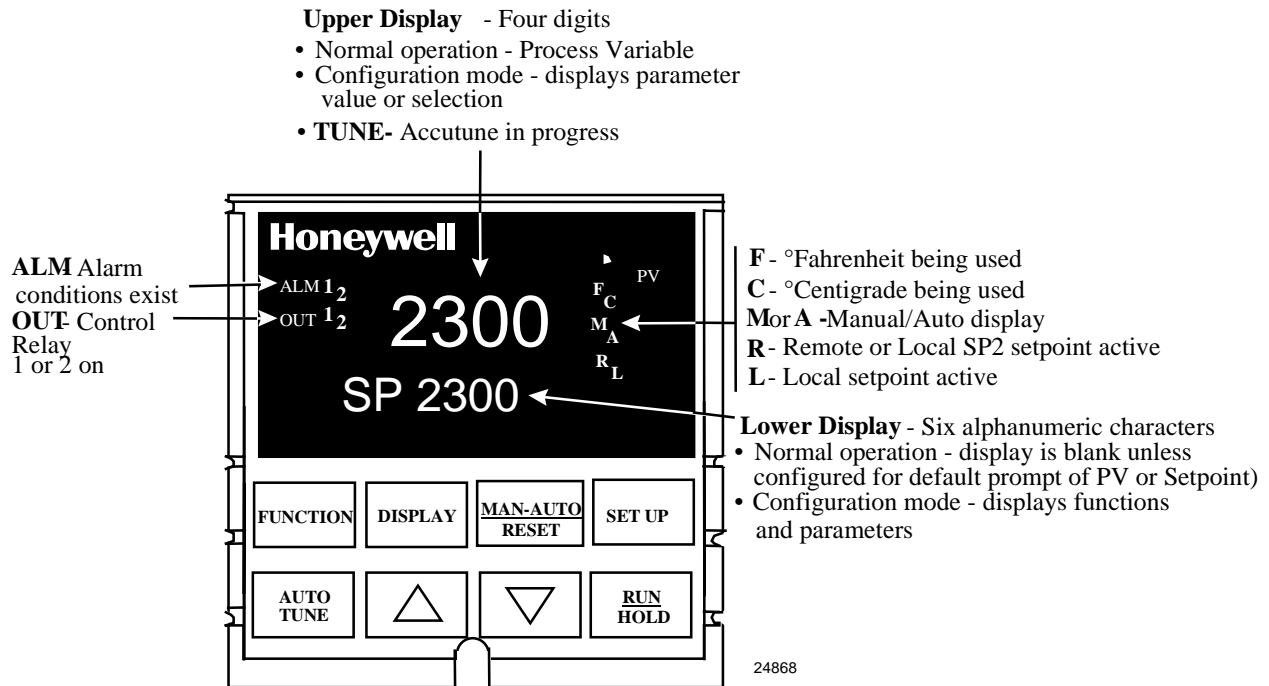

Figure 5-1 Operator Interface

## 5.3 Entering a Security Code

### Introduction

The level of keyboard lockout may be changed in the Set Up mode. However, knowledge of a security code number (0 to 4095) may be required to change from one level of lockout to another. When a controller leaves the factory, it has a security code of 0 which permits changing from one lockout level to another without entering any other code number.

### Procedure

If you require the use of a security code, select a number from 0001 to 4095 and enter it when the lockout level is configured as NONE. Thereafter, that selected number must be used to change the lockout level from something other than NONE.

**CAUTION** Write the number on the Configuration Record Sheet in the configuration section so you will have a permanent record.

**Table 5-1 Procedure to Enter a Security Code**

Step	Operation	Press	Result
1	Enter Set Up Mode	<input type="button" value="SET UP"/>	Upper Display = <b>SET UP</b> Lower Display = <b>TUNING</b>
2	Select any Set Up Group	<input type="button" value="FUNCTION"/>	Upper Display = <b>0</b> Lower Display = <b>SECUR</b>
3	Security Code Entry	[▲] [▼]	To enter a four digit number in the upper display (0001 to 4095)  This will be your security code.

## 5.4 Lockout Feature

### Introduction

The lockout feature in the UDC 2300 is used to inhibit changes (via keyboard) of certain functions or parameters by unauthorized personnel.

### Lockout levels

There are different levels of Lockout depending on the level of security required. These levels are:

- **NONE** No Lockout. All groups Read/Write.
- **CAL** Calibration prompts are deleted from the Setup List.
- **CONF** Timer, Tuning, SP Ramp, and Accutune are Read/Write. All other Setup groups are Read only. Calibration Group is not available.
- **VIEW** Timer, Tuning, and SP Ramp are Read/Write. No other parameters are available.
- **ALL** Timer, Tuning, and SP Ramp are Read only. No other parameters are viewable.

See *Subsection 4.5 - Tuning Parameters Set Up Group* prompts to select one of the above.

Security Code (*see Subsection 5.3*)

## Individual key lockout

There are four keys that can be disabled to prevent unauthorized changes to the parameters associated with these keys. *First set the “Lock” prompt to NONE.*

These keys are:

- AUTOTUNE** Key - you can disable the Autotune key at configuration Set Up, group prompt “Tuning”, function prompt “A TUNE”
- RUN/HOLD** Key - you can disable the Run/Hold key for Set Point Programming at configuration Set Up group prompt “Tuning,” function prompt “RN HLD.”
- AUTO/MAN** Key - you can disable the Auto/Manual key at configuration Set Up, group prompt “Tuning”, function prompt “AUTOMA”
- FUNCTION** Key - you can disable the Set Point Select function key at configuration Set Up group prompt “Tuning,” function prompt “SP SEL.”

See *Subsection 4.5 - Tuning Parameters Set Up Group* prompts to enable or disable these keys.

## Key error

When a key is pressed and the prompt “Key Error” appears in the lower display, it will be for one of the following reasons:

- Parameter not available or locked out
- Not in setup mode, press **SET UP** key first
- Individual key locked out.

## 5.5 Monitoring Your Controller

### Annunciators

The following annunciator functions have been provided to help monitor the controller:

**Table 5-2 Annunciators**

Annunciator	Indication
<b>ALM 1 2</b>	<p><i>A visual indication of each alarm</i></p> <p>Blinking 1 indicates alarm latched and needs to be acknowledged before extinguishing when the alarm condition ends</p>
<b>OUT 1 2</b>	<p><i>A visual indication of the control relays</i></p>
<b>A or M</b>	<p><i>A visual indication of the mode of the controller</i></p> <p><b>A</b>—Automatic Mode</p> <p><b>M</b>—Manual Mode</p>
<b>F or C</b>	<p><i>A visual indication of the temperature units</i></p> <p><b>F</b>—Degrees Fahrenheit</p> <p><b>C</b>—Degrees Celsius</p>
<b>L or R</b>	<p><i>A visual indication of setpoint being used</i></p> <p><b>L</b>— Local Setpoint is active</p> <p><b>R</b>— RSP or LSP 2 is active</p> <p><i>The upper display is used to show other annunciator functions</i></p> <p><b>TUNE</b>—Accutuning in progress</p> <p><b>RUN</b>—SP Program in progress</p> <p><b>HOLD</b>—SP Program on hold</p> <p><b>CSP</b>—Controlling to the Computer Setpoint</p> <p><b>LOOPBK</b>—Loopback Test running</p>

## Viewing the operating parameters

Press the **DISPLAY** key to scroll through the operating parameters listed in Table 5-3. The lower display will show only those parameters and their values that apply to your specific model.

**Table 5-3 Lower Display Key Parameter Prompts**

Lower Display	Description
<b>OT</b>	OUTPUT—Output value is percent; for Three Position Step control, this is an estimated motor position when no slidewire exists.
<b>SP</b>	LOCAL SETPOINT #1—Also current setpoint when using SP Ramp.
<b>2L</b>	LOCAL SETPOINT #2
<b>RS</b>	REMOTE SETPOINT
<b>2ND</b>	INPUT 2
<b>DE</b>	DEVIATION—Maximum negative display is -999.9.
<b>PIDSX</b>	TUNING PARAMETER SELECTED SET—where X is either 1 or 2.
↙ □.□□	TIME REMAINING—Time that remains on timer in Hours.Minutes
↗ □.□□	ELAPSED TIME—Time that has elapsed on timer in Hours.Minutes.
<b>RPXXM</b>	SETPOINT RAMP TIME—Time remaining in the setpoint ramp in minutes.
<b>AX</b>	AUXILIARY OUTPUT
<b>Sn</b>	SP RATE SETPOINT—Current setpoint for setpoint rate applications
<b>BI</b>	BIAS—Displays the manual reset value for algorithm PD+MR.
<b>To BGr</b>	TO BEGIN—Resets Setpoint Program back to beginning of the program.

## Diagnostic Error Messages

The UDC 2300 performs background tests to verify data and memory integrity. If there is a malfunction, an error message will be displayed. In the case of more than one simultaneous malfunction, the messages will be displayed sequentially on the lower display. If any of these error messages in Table 5-4 occur, refer to *Section 10 - Troubleshooting* for information to correct the failure.

**Table 5-4 Error Messages**

Prompt	Description
<b>EE FAIL</b>	Unable to write to nonvolatile memory.
<b>IN1FL</b>	Two consecutive failures of input 1 integration.
<b>IN2FL</b>	Two consecutive failures of input 2 integration.
<b>CFGERR</b>	Configuration Errors—Low limit greater than high limit for PV, SP, Reset, or Output.
<b>IN1RNG</b>	Input 1 Out-of-Range Out-of-range criteria: Linear range: $\pm 10\%$ out-of-range Characterized range: $\pm 1\%$ out-of-range
<b>IN2RNG</b>	Input 2 Out-of-Range—Same as Input 1.
<b>PV LIM</b>	PV Out-of-Range $PV = (PV \text{ source} \times PV \text{ source ratio}) + PV \text{ source bias}$
<b>FAILSF</b>	Failsafe — conditions for failsafe are: ... EEROM Test Failed ... Scratch Pad RAM Test Failed ... Configuration Test Failed ... Field or Factory Cal Test Failed  Check the “Status” group.
<b>RV LIM</b>	Remote Variable Out-of-Range $RV = (RV \text{ source} \times RV \text{ source ratio}) + RV \text{ source bias}$
<b>SEG ERR</b>	Segment Error—SP Program starting segment number is less than ending segment number.
<b>LOCK</b>	The lockout feature has been enabled to prevent unauthorized changes of certain functions or parameters.





## 6 Operation

### 6.1 Overview

#### Introduction

This section gives you all the information necessary to operate your controller. Review the Operator Interface and Key Functions shown in Figure 3-1. Make sure you are familiar with the indicator definitions listed in Table 5-2.

#### What's in this section?

The following topics are covered in this section.

TOPIC	See Page
6.1 Overview	53
6.2 Single Display Functionality	54
6.3 Start Up Procedure for Operation	54
6.4 Control Modes	57
0 Setpoints	58
6.6 Timer	59
6.7 Accutune	61
6.8 Fuzzy Overshoot Suppression	64
6.9 Using Two Sets Of Tuning Constants	64
6.10 Alarm Setpoints	66
6.11 Three Position Step Control Algorithm	67
6.12 Setting A Failsafe Output Value For Restart After A Power Loss	68
6.13 Setting Failsafe Mode	69

## 6.2 Single Display Functionality

### Introduction

A UDC 2300 instrument, which has been configured with a '0' for software options (i.e., DC230x-xx-x0-xx), will only have a single display capability. This means that the displayed value of PV, Setpoint, Setpoint2, Remote Setpoint, Input 2, Output, Bias, Aux Out, and Deviation will appear on the top display and a prompt identifying the value will appear on the bottom display.

### Access the Values

Pressing the **DISPLAY** key will cycle through all applicable values (configuration dependent). One minute after the last press of the display key, the display will revert back to a configured default display. The default display is configured in the Input 1 Setup Group, and has three selections:

- Active Setpoint (**SP**)
- Process Variable (**PR Y**)
- Process Variable with no bottom display prompt (**PR n**).

### Exceptions

*There are three exceptions to the above rules.* The displays for PID SET, Timer and Setpoint Ramp will appear the same as on a dual display model and, when displaying Timer or Ramp values, the default display switchover feature is disabled.

### Auto-only Mode

The single display model is *Auto only* mode. The Auto/Manual key has no effect on controller mode. As a result of this, the failsafe mode is always non-latching.

While a failsafe condition exists, the controller output will assume the failsafe value. When the failsafe condition goes away, normal automatic operation continues.

## Single Display Parameters

**Table 6-1 Single Display Parameters**

Lower Display Prompt	Upper Display Value	Comments
(blank)	Process Variable	Default selection
PV	Process Variable	Default selection
SP	Local Setpoint #1	Default selection
2SP	Local Setpoint #2	Default selection
RSP	Remote Setpoint	Default selection
OUT	Output	
DEV	Deviation	
2IN	Input #2	
AUX	Aux Output value	
BIA	PD+MR bias value	
PIDS x	Process Variable	Active PID set
RP xxxM	Process Variable	SP Ramp time left
HH.MM or MM.SS	Process Variable	Timer display

### 6.3 Start Up Procedure for Operation

**Table 6-2 Procedure for Starting Up the Controller**

Step	Operation	Press	Result		
1	Select Manual Mode	<table border="1" style="text-align: center; width: 80px; height: 30px;"><tr><td>MAN/AUTO</td></tr><tr><td>RESET</td></tr></table>	MAN/AUTO	RESET	Until "M" indicator is ON. The controller is in manual mode.  <b>N/A for Single Display model.</b>
MAN/AUTO					
RESET					
2	Adjust the Output	[▲] [▼]	To adjust the output value and ensure that the final control element is functioning correctly.  <i>Upper Display = Pv Value</i> <i>Lower Display = OT and the output value in %</i>		
3	Tune the Controller	<table border="1" style="text-align: center; width: 80px; height: 20px;"><tr><td>SET UP</td></tr></table>	SET UP	Make sure the controller has been configured properly and all the values and selections have been recorder on the Configuration Record Sheet.  Refer to Tuning Set Up group to ensure that the selections for P Bor GAIN, RATE T, and I MIN, or I RPM have been entered.  <b>Use Accutune to tune the controller; see the procedure in this section.</b>	
SET UP					
4	Enter the Local Setpoint	<table border="1" style="text-align: center; width: 80px; height: 20px;"><tr><td>DISPLAY</td></tr></table>  [▲] [▼]	DISPLAY	<i>Upper Display = Pv Value</i> <i>Lower Display = SP and the Local Setpoint Value</i>  to adjust the local setpoint to the value at which you want the process variable maintained.  The local setpoint cannot be changed if the Setpoint Ramp function is running.	
DISPLAY					
5	Select Automatic Mode	<table border="1" style="text-align: center; width: 80px; height: 30px;"><tr><td>MAN/AUTO</td></tr><tr><td>RESET</td></tr></table>	MAN/AUTO	RESET	Until "A" indicator is ON. The controller is in Automatic mode.  The controller will automatically adjust the output to maintain the process variable at setpoint.  <b>N/A for Single Display model.</b>
MAN/AUTO					
RESET					

## 6.4 Control Modes

### ATTENTION

After changing a Local Setpoint value, if no other key is pressed, it then takes a minimum of thirty (30) seconds elapsed time before the new value is stored in non-volatile memory. If controller power is removed before this time, the new setpoint value is lost and the previous setpoint value is used at power-up. If, after changing the LSP value, another key is pressed, then the value is stored immediately.

### 6.4.1 Mode Definitions

**Table 6-3 Control Mode Definitions**

Control Mode	Definition
<b>AUTOMATIC with LOCAL SETPOINT</b>	<p>In automatic local mode, the controller operates from the local setpoints and automatically adjusts the output to maintain the PV at the desired value. In this mode you can adjust the setpoint.                      See <i>Subsection 6.5 - Setpoints</i>.</p>
<b>AUTOMATIC with REMOTE SETPOINT</b>	<p>In automatic remote mode, the controller operates from the setpoint measured at the remote setpoint input. Adjustments are available to ratio this input and add a constant bias before it is applied to the control equation.                      See <i>Subsection 4.9 or 4.10, Input 1 or Input 2</i>.</p>
<b>MANUAL</b>	<p>In the manual mode, the operator directly controls the controller output level. The process variable and the percent output are displayed. The configured High and Low Output Limits are disregarded and the operator can change the output value, using the increment and decrement keys, to the limits allowed by the output type (0 % to 100 % for a time proportioning output or -5 % to 105 % for a current output).</p>
<p><b>Manual not available with Single Display model.</b></p>	

## 6.4.2 What happens when you change modes

**Table 6-4 Changing Control Modes (Dual Display Only)**

Control Mode	Definition
<b>Manual to Automatic Local Setpoint</b>	The Local Setpoint is usually the value previously stored as the Local Setpoint. PV tracking is a configurable feature which modifies this. For this configuration, when the controller is in manual mode, the local setpoint value tracks the process variable value continuously.
<b>Manual or Auto Local to Automatic Remote SP</b>	The Remote Setpoint uses the stored ratio and bias to calculate the control setpoint.
<b>Automatic Remote Setpoint to Manual or Auto Local Setpoint</b>	If configured for local setpoint tracking, RSP, when the controller transfers out of remote setpoint the last value of the remote setpoint is inserted into the local setpoint. If LSP tracking is not configured, the local setpoint will not be altered when the transfer is made.

## 6.5 Setpoints

### Introduction

You can configure the following setpoints for the UDC 2300 controller.

- A Single Local Setpoint
- 2 Local Setpoints
- a Local Setpoint and a Remote Setpoint

Refer to *Subsection 4.11 – Control Set Up Group* for configuration details.

### Changing the Setpoints

**Table 6-5 Procedure for Changing the Local Setpoints**

Step	Operation	Press	Result
1	Select the Setpoint	DISPLAY	Until you see: <i>Upper Display = PV</i> <i>Lower Display = SP or 2L (Value)</i>
2	Change the Value	[▲] [▼]	To change the Local Setpoint to the value at which you want the process maintained. The display “blinks” if you attempt to enter setpoint values beyond the high and low limits..
3	Return to PV Display	DISPLAY	To store immediately or will store after 30 seconds.

## Switching between setpoints

You can switch Local and Remote setpoints or between two Local setpoints when configured.

**ATTENTION** The REMOTE SETPOINT value cannot be changed at the keyboard.

**Table 6-6 Procedure for Switching Between Setpoints**

Step	Operation	Press	Result
1	Select the Setpoint	<b>FUNCTION</b>	<p>To alternately select Local Setpoint 1 (LSP) and the Remote Setpoint (RSP) or switch between the 2 Local Setpoints (LSP and 2L)</p> <p><b>ATTENTION</b> “KEY ERROR” will appear in the lower display, if:</p> <ul style="list-style-type: none"> <li>• the remote setpoint or 2<sup>nd</sup> local setpoint is not configured as a setpoint source</li> <li>• you attempt to change the setpoint while a setpoint ramp is enabled, or</li> <li>• if you attempt to change the setpoint with the setpoint select function key disabled.</li> </ul>

## 6.6 Timer

### Introduction

The Timer provides a configurable Time-out period of from 0 to 99 hours:59 minutes or 0 to 99 minutes:99 seconds.

Timer “Start” is selectable as either the **RUN/HOLD** key or Alarm 2.

The Timer display can be either “Time Remaining” or “Elapsed Time”.

### Configuration check

Make sure:

- TIMER is enabled
- A TIMEOUT period has been selected (in hours and minutes or minutes and seconds)
- A TIMER FUNCTION START has been selected (KEY or AL2)
- A TIMER display has been selected (Time remaining or Elapsed time)
- A timer increment selected
- Timer reset selected

Refer to *Subsection 4.4 - Timer Set Up Group* for details.

### Viewing Times

The times are viewed on the lower display as follows:

TIME REMAINING will show as a *decreasing* Hrs:Min value (HH:MM) or Min:Sec value (MM:SS) plus a *counterclockwise* rotating clock face.

ELAPSED TIME will show as an *increasing* Hrs:Min value(HH:MM) or Min:Sec value (MM:SS) plus a *clockwise* rotating clock face.

### Operation

When the Timer is enabled (RUN/HOLD key or ALARM 2), it has exclusive control of Alarm 1 relay.

At “TIME-OUT”:

- Alarm 1 is active
- The clock character has stopped moving
- The Time display shows either 00:00 or the time-out period depending on the configuration selection
- The Timer is ready to be reset

At “RESET”:

- Alarm 1 relay is inactive
- The time display shows the time-out period
- The time-out period can be changed at this time using the ▲ or ▼ keys.
- The Timer is ready to be activated



## 6.7 Accutune II

### Introduction

AccutuneII (TUNE) may be used for self-regulating and single integrating processes. This autotuning method is initiated on-demand, typically at initial start-up.

There are no other requirements necessary, such as prior knowledge to the process dynamics or initial or post tune process line-out to setpoint or manual output.

Also, the setpoint value is not required to change in order to initiate the tuning process, but the controller must be in the Automatic mode to start tuning.

### Configuration check

Make sure:

- TUNE has been enabled see to *Subsection 4.7 - Accutune Set Up Group* for details.
- Key Enabled – see *Subsection 4.5 – Tuning Set Up Group* for details.

### Tuning indicators

“TUNE” will flash in the upper display until tuning is completed.

### Operation

“TUNE” (Accutune II) algorithm provides foolproof, trouble-free on-demand tuning in the UDC 2300 controller. No knowledge of the process is required at start-up. The operator simply initiates the tuning while in the automatic mode.

The UDC controller immediately starts controlling to the setpoint while it identifies the process, calculates the tuning constants and enters them into the Tuning group, and begins PID control with the correct tuning parameters. This works with any process, including integrating type processes, and allows retuning at a fixed setpoint.

The tuning sequence will cycle the controller’s output two full cycles between 0 % and 100 % (or low and high output limits) while allowing only a very small Process Variable change above and below the SP during each cycle. “TUNE” flashes in the upper display until tuning is completed.

After “TUNE” has been enabled, you can start Accutune as shown in Table 6-7.

**Table 6-7 Procedure for Starting “TUNE”**

Step	Operation	Press	Result
1	Switch to “Automatic” Mode	<div style="border: 1px solid black; padding: 2px; display: inline-block;">                     MAN/AUTO RESET                 </div>	Until you “A” indicator is lit.
2	Initiate Accutune	<div style="border: 1px solid black; padding: 2px; display: inline-block;">                     AUTO TUNE                 </div>	

## Tune for Duplex (Heat/Cool)

“TUNE” can be done for applications using Duplex (Heat/Cool) control.

During tuning, Accutune II assumes SP 1 will cause a Heating demand, and then then the calculated tuning parameters will be automatically entered as PID SET 1. Likewise, it assumes tuning at Local SP 2 will cause a Cooling demand, and the cooling parameters will be entered as PID SET 2.

## Configuration Check for Duplex

Make sure:

- TUNE has been enabled see to *Subsection 4.7 - Accutune Set Up Group* for details.
- Key Enabled – see *Subsection 4.5 – Tuning Set Up Group* for details.

## Using TUNE at start-up for Duplex (Heat/Cool)

**Table 6-8 Procedure for Using TUNE at Start-up for Duplex Control**

Step	Action
1	<p><b>Heat Zone:</b></p> <p>a. Adjust the <b>Local SP1</b> to a value within the <b>Heat</b> Zone.</p> <p>b. Insure that the UDC is in <i>Automatic</i> mode.</p> <p>c. Press the <b>AUTOTUNE</b> key to initiate <b>Heat</b> zone tuning. The output will cycle between 50 % and 100 % (or high output limit). “TUNE” flashes in the upper display until tuning is completed and final <b>Heat</b> parameters are entered for <b>PID Set 1</b> in the Tuning group.</p>
2	<p><b>Cool Zone:</b></p> <p>a. Adjust the <b>Local SP2</b> to a value within the <b>Cool</b> Zone.</p> <p>b. Insure that the UDC is in <i>Automatic</i> mode.</p> <p>c. Press the <b>AUTOTUNE</b> key to initiate <b>Cool</b> tuning. The output will cycle between 0 % and 50 % (or low output limit). “TUNE” FLASHES IN THE UPPER DISPLAY UNTIL TUNING IS COMPLETED AND FINAL <b>COOL</b> PARAMETERS ARE ENTERED FOR <b>PID SET 2</b> IN THE TUNING GROUP.</p>

---

## Error Codes

**Table 6-9 Procedure for Accessing Accutune Error Codes**

Step	Operation	Press	Result
1	Select Accutune Set-up Group	<b>SET UP</b>	Upper Display = <b>SET</b> Lower Display = <b>ATUNE</b>
2	Go to Error Code Prompt	<b>FUNCTION</b>	Upper Display = <b>(an error code)</b> Lower Display = <b>ATERR</b> <b>Table 6-10 lists all the error codes, definitions, and fixes.</b>

**Table 6-10 Accutune Error Codes**

Error Code (Upper Display)	Definition	Fix
<b>RUN</b>	ACCUTUNE RUNNING	The Accutune process is still active (Read Only)
<b>NONE</b>	NO ERRORS OCCURRED DURING LAST ACCUTUNE PROCEDURE	None
<b>IDFL</b>	PROCESS IDENTIFICATION FAILURE Autotune has aborted because an illegal value of GAIN, RATE, or reset was calculated.	<ul style="list-style-type: none"> <li>Illegal Values – try Accutune again.</li> <li>untunable process -- contact local application engineer.</li> </ul>
<b>ABRT</b>	CURRENT ACCUTUNE PROCESS ABORTED caused by the following conditions: <i>a. Operator changed to Manual mode</i> <i>b. Digital Input detected</i> <i>c. In Heat region of output and a Cool output calculated or vice versa.</i>	Try Accutune again

### Aborting Accutune

To abort Accutune and return to the last previous operation (SP or output level), press **MAN-AUTO/RESET** key to abort the Accutune process.

### Completing Accutune

When Accutune is complete, the calculated tuning parameters are stored in their proper memory location in the controller, and the controller will control at the local setpoint using the newly calculated tuning constants.

## 6.8 Fuzzy Overshoot Suppression

### Introduction

Fuzzy Overshoot Suppression minimizes Process Variable overshoot following a setpoint change or a process disturbance. This is especially useful in processes which experience load changes or where even a small overshoot beyond the setpoint may result in damage or lost product.

### How it works

The fuzzy logic observes the speed and direction of the PV signal as it approaches the setpoint and temporarily modifies the internal controller response action as necessary to avoid an overshoot. There is no change to the PID algorithm, and the fuzzy logic does not alter the PID tuning parameters. This feature can be independently Enabled or Disabled as required by the application to work with “TUNE” (On-Demand) Accutune II tuning algorithm.

### Configuration

To configure this item, refer to Section 4 - Configuration:

Set Up Group “**ATUNE**”

Function Prompt “**FUZZY**”

Select “**ENAB**”(enable) or “**DIS**” (disable) - Use ▲ or ▼.

## 6.9 Using Two Sets of Tuning Constants

### Introduction

You can use two sets of tuning constants for single output types and choose the way they are to be switched. (Does not apply for Duplex control..)

The sets can be:

- keyboard selected,
- automatically switched when a predetermined process variable value is reached,
- automatically switched when a predetermined setpoint value is reached.

### Set up Procedure

The following procedure (Table 6-11) to:

- select two sets,
- set the switch-over value,
- set tuning constant value for each set.

**Table 6-11 Set Up Procedure**

Step	Operation	Press	Result
1	Select Control Set-up Group	SET UP	Until you see: <i>Upper Display = SET</i> <i>Lower Display = CONTRL</i>
2	Select PID SETS	FUNCTION	Until you see: <i>Upper Display = (available selections)</i> <i>Lower Display = PID SETS</i>
3	Select PID SETS Function	[▲] [▼]	To select the type of function. Available selections are: <b>ONE</b> —1 set of constants <b>2 KBD</b> —2 sets, keyboard selectable <b>2 PR</b> —2 sets, auto switch at PV value <b>2 SP</b> —2 sets, auto switch at SP value
4	Set Tuning Values for Each Set		Refer to “TUNING” Set up group, subsection 4.5 and set the following tuning parameters:  PB or GAIN* RATE T* I MIN or I RPM* CYCT1 or CTIX3* PB2 or GAIN2** RATE 2T** I2MIN or I2RPM** CYC2T2 or CT2X3**  *PIDSET1 will be used when PV or SP, whichever is selected, is <b>greater</b> than the switchover value.  **PIDSET2 will be used when PV or SP, whichever is selected, is <b>less</b> than the switchover value.
5	Set Switchover Value for 2PR or 2SP Selection	FUNCTION	Until you see: <i>Upper Display = (the switchover value)</i> <i>Lower Display = SW VAL</i>
		[▲] [▼]	To select the switchover value in the upper display.

**Switch between two sets via keyboard (without automatic switch-over)**

**Table 6-12 Procedure for Switching PID SETS from the Keyboard**

Step	Operation	Press	Result
1	Select Control Set-up Group	DISPLAY	Until you see: <i>Upper Display = (the PV value)</i> <i>Lower Display = PIDS X (X= 1 or 2)</i>
2		[▲] [▼]	To change PID SET 1 to PID SET2 or Vice Versa. You can use Accutune on each set.

## 6.10 Alarm Setpoints

### Introduction

An alarm consists of a relay contact and an operator interface indication. The alarm relay is de-energized if setpoint 1 or setpoint 2 is exceeded.

The alarm relay is energized when the monitored value goes into the allowed region by more than the hysteresis.

The relay contacts can be wired for normally open (NO) energized or normally closed (NC) de-energized using internal jumper placement. See Table 2-4 in the *Section 2 – Installation* for alarm relay contact information.

There are four alarm setpoints, two for each alarm. The type and state (High or Low) is selected during configuration. See *Subsection 4.13 – Configuration* for details.

### Alarm Setpoints Display

**Table 6-13 Procedure for Displaying Alarm Setpoints**

Step	Operation	Press	Result
1	Select Alarm Set-up Group	SET UP	Until you see: <i>Upper Display = SET</i> <i>Lower Display = ALARMS</i>
2	Access the Alarm Setpoint Values	FUNCTION	To successively display the alarm setpoints and their values. Their order of appearance is shown below. <i>Upper Display = (the alarm setpoint value)</i> <i>Range values are within the range of the selected parameters except:</i> <b>DEVIATION (DE)</b> value = PV Span <b>EVENTS (E-ON/E-OFF)</b> value = Event Segment Number <b>PV RATE OF CHANGE (PVRT)</b> = The amount of PV change in one minute in engineering units. <b>LOOP BREAK ALARMS (BRAK)</b> = The timer value may be changed only for controllers configured for ON/OFF. <i>Lower Display = A1S1VA = Alarm 1, Setpoint 1</i> <i>A1S2VA = Alarm 1, Setpoint 2</i> <i>A2S1VA = Alarm 2, Setpoint 1</i> <i>A2S2VA = Alarm 2, Setpoint 2</i>  NOTES: <b>With 3 position step control, the alarms set for “output” will not function.</b> <b>MAN, RSP, AND FSAF selections do not have setpoint values.</b>
3	Change a value	[▲] [▼]	To change any alarm setpoint value in the upper display.
4	Return to Normal Display	DISPLAY	

## 6.11 Three Position Step Control Algorithm

### Introduction

The Three Position Step Control algorithm allows the control of a valve (or other actuator) with an electric motor driven by two controller output relays; one to move the motor upscale, the other to move it downscale, without a feedback slidewire linked to the motor shaft.

### Estimated Motor Position

The Three Position Step control algorithm provides an output display (“OT”) which is an estimated motor position since the motor is not using any feedback.

- Although this output indication is only accurate to a few percent, it is corrected each time the controller drives the motor to one of its stops (0 % or 100 %).
- It avoids all the control problems associated with the feedback slidewire (wear, dirt, and noise).
- When operating in this algorithm, the estimated “OT” display is shown to the nearest percent (that is, no decimal).

Refer to Subsection 9.4 to set the Motor Travel Time (the time it takes the motor to travel from 0 % to 100 %).

### Motor Position Display

**Table 6-14 Procedure for Displaying 3Pstep Motor Position**

Step	Operation	Press	Result
1	Access the Displays	<input type="button" value="DISPLAY"/>	Until you see: <i>Upper Display = PV</i> <i>Lower Display = OT (The estimated motor position in %)</i>

## 6.12 Setting a Failsafe Output Value for Restart After a Power Loss

### Introduction

If the power to the controller fails and power is reapplied, the controller goes through the power up tests, then goes to a user configured FAILSAFE OUTPUT VALUE.

### Set a Failsafe Value

**Table 6-15 Procedure for Setting a Failsafe Value**

Step	Operation	Press	Result
1	Select Control Set-up Group	<b>SET UP</b>	Until you see: <i>Upper Display = SET</i> <i>Lower Display = CONTRL</i>
2	Select Failsafe Function Prompt	<b>FUNCTION</b>	You will see: <i>Upper Display = (range)</i> <i>within the range of the Output 0 to 100 for all output types except 3 Position Step</i> <b>3 Position Step</b> <i>0 = motor goes to closed position</i> <i>100 = motor goes to open position</i> <i>Lower Display = FAILSF</i>
3	Select a value	<b>[▲] [▼]</b>	To select a failsafe output value in the upper display
4	Return to Normal Display	<b>DISPLAY</b>	At power up, the output will go to the value set.

---



## 6.13 Setting Failsafe Mode

### Introduction

You can set the Failsafe Mode to be Latching or Non-Latching.

### Set Failsafe Mode

**Table 6-16 Procedure for Setting a Failsafe Mode**

Step	Operation	Press	Result
1	Select Control Set-up Group	<b>SET UP</b>	Until you see: <i>Upper Display</i> = <b>SET</b> <i>Lower Display</i> = <b>CONTRL</b>
2	Select Failsafe Function Prompt	<b>FUNCTION</b>	You will see: <i>Upper Display</i> = <b>LACH</b> (Controller goes to manual and output goes to failsafe value) <b>NO L</b> (Controller mode does not change and output goes to failsafe value) <i>Lower Display</i> = <b>FSMODE</b>
3	Select a value	<b>[▲] [▼]</b>	To select a failsafe mode in the upper display.
4	Return to Normal Display	<b>DISPLAY</b>	At power up, the output will go to the value set.



## 7 Setpoint Rate/Ramp/Program Operation

### 7.1 Overview

#### Introduction

The Setpoint Ramp configuration group lets you enable and configure any of the following:

- **SPRATE** – a specific rate of change for any local setpoint change. (Subsection 7.2)
- **SPRAMP** – a single setpoint ramp that occurs between the current local setpoint and a final local setpoint over a time interval of 1 to 255 minutes. (Subsection 7.3)
- **SPPROG** – a ramp/soak profile in a 12-segment program. (Subsection 7.4)

This section explains the operation of each selection and configuration reference where necessary.

#### ATTENTION

For any option to function, the other options must be disabled (see *Subsection 4.6 – Configuration*).

#### PV Hot Start

This is a standard feature. At power-up, the setpoint is set to the current PV value and the Rate or Ramp or Program then starts from this value.

#### RUN/HOLD key

You can start or stop the Ramp or Program using the RUN/HOLD key.

#### What's in this section?

The following topics are covered in this section.

TOPIC	See Page
7.2 Setpoint Rate	72
7.3 Setpoint Ramp	72
7.4 Setpoint Ramp/Soak Programming	74

## 7.2 Setpoint Rate

### Introduction

When you have configured a SETPOINT RATE, it will apply immediately to local setpoint change.

### Configuration check

Make sure:

- SPRATE is enabled
- SPRAMP and SPPROG are disabled
- A Rate Up (EUHRUP) or Rate Down (EUHRDN) value has been configured in Engineering units per hour.

**ATTENTION:** A value of 0 will imply an immediate change in setpoint, that is, NO RATE applies. See Subsection 4.6 – Configuration group “SPRAMP” for details.)

### Operation

When a change to local setpoint is made, this controller will ramp from the original setpoint to the “target” setpoint at the rate specified.

The current setpoint value can be viewed at Sn on the lower display.

### Power outages

If power is lost before the “target” setpoint is reached, upon power recovery, the controller powers up with Sn = Current PV value and it automatically “Restarts” from Sn = current PV value up to the original “target” setpoint.

## 7.3 Setpoint Ramp

### Introduction

When you have configured a SETPOINT RAMP, the ramp will occur between the current local setpoint and a final local setpoint over a time interval of from 1 to 255 minutes. You can RUN or HOLD the ramp at any time.

### Configuration Check

Make sure

- SPRAMP is enabled
- SP RATE and SPPROG are disabled
- A Ramp Time (TIMIN) in minutes has been configured
- A final setpoint value (FINLSP) has been configured. See Subsection 4.6 – Configuration group “SPRAMP” for details.

## Operation

Running a Setpoint Ramp includes starting, holding, viewing the ramp, ending the ramp and disabling it. See Table 7-1.

**Table 7-1 Running A Setpoint Ramp**

Step	Operation	Press	Result
1	Select Automatic Mode	MAN/AUTO	"A" indicator is on. <i>Upper Display</i> = Hold and PV value <i>Lower Display</i> = SP and Present value
2	Set Start Setpoint	DISPLAY	Until start SP value is in lower display <i>Upper Display</i> = Hold and PV value <i>Lower Display</i> = SP and start SP value
3	Start the Ramp	RUN/HOLD	You will see <i>Upper Display</i> = Run and a changing PV value <i>Lower Display</i> = SP and a changing SP value increasing or decreasing toward a final SP value
4	Hold/Run the Ramp	RUN/HOLD	This holds the ramp at the current setpoint value. Press again to continue.
5	View the remaining ramp time	DISPLAY	Until you see <i>Upper Display</i> = RUN or HOLD and the PV value <i>Lower Display</i> = <b>RP xx HH.MM</b> (time remaining)
6	End the Ramp		When the final setpoint is reached, "RUN" changes to "HOLD" in the upper display and the controller operates at the new final setpoint.
7	Disable SPRAMP		See Section 4 – Configuration group "SPRAMP" for details.

## Power Outage

If power is lost during a ramp, upon power-up the controller will be in HOLD and the setpoint value will be the setpoint value prior to the beginning of the setpoint ramp.

The ramp is placed in hold at the beginning.

Configure the mode at Set Up Group "CONTROL", function prompt "PWRUP". See Subsection 4.11 – CONTRL GROUP FUNCTION Prompts.

## 7.4 Setpoint Ramp/Soak Programming

### Introduction

The term “programming” is used here to identify the process for selecting and entering the individual ramp and soak segment data needed to generate the rEquired setpoint versus time profile (also called a program).

A segment is a ramp or soak function which together make up a setpoint program. Setpoint Ramp/Soak Programming lets you configure six ramp and six soak segments to be stored for use as one program or several small programs. You designate the beginning and end segments to determine where the program is to start and stop.

### Review program data and configuration

While the procedure for programming is straightforward, and aided by prompts, we suggest you read “Program Contents”. Table 7-2 lists the program contents and an explanation of each to aid you in configuration. Then refer to Subsection 4.6 – Configuration to do the setpoint program.

Make sure SPRATE and SPRAMP are disabled.

### Fill out the worksheet

Refer to the example in Figure 7-1 and draw a Ramp/Soak Profile on the worksheet provided (Figure 7-2) and fill in the information for each segment. This will give you a record of how the program was developed.

### Operation

Refer to Table 7-3 Run/Monitor the program.

### Program Contents

Table 7-2 lists all the program contents and a description of each.

Table 7-2 Program Contents

Contents	Definition
<b>Ramp time or rate segments</b>	<p>A ramp segment is the time or rate of change it takes to change the setpoint to the next setpoint value in the program.</p> <ul style="list-style-type: none"> <li>• Ramps are odd number segments. Segment #1 will be the initial ramp time.</li> <li>• Ramp time is determined in either:               <p style="margin-left: 40px;">TIME* - Hours:Minutes      Range = 0-99 hr.:59 min.</p> <p style="text-align: center;">or</p> <p style="margin-left: 40px;">EU-M* - Degrees/Minute Range = 0 to 999 EU-H* - Degrees/Hour</p> </li> </ul> <p>*The selection of time or rate is made at prompt "RP UNIT" - Set this prompt before entering any Ramp information.</p> <div style="border: 1px solid black; padding: 2px; display: inline-block;"><b>ATTENTION</b></div> Entering "0" will imply an immediate step change in setpoint to the next soak.
<b>Ramp unit</b>	<p>The ramp unit selection determines the engineering units for the ramp segments.</p> <p>The selections are:</p> <ul style="list-style-type: none"> <li>• TIME = Hours:Minutes (XX:XX) Range: 0-99 hr.:0-59 min</li> <li>• EU-H = Degrees/Hour    OR    EU-M = Degrees/Minute (Range – 0-999)</li> </ul>
<b>Soak segments</b>	<p>A soak segment is a combination of soak setpoint (value) and a soak duration (time).</p> <ul style="list-style-type: none"> <li>• Soaks are even number segments.</li> <li>• Segment 2 will be the initial soak value and soak time.</li> <li>• The soak setpoint range value must be within the setpoint high and low range limits in engineering units.</li> <li>• Soak time is the duration of the soak and is determined in:               <p style="margin-left: 40px;">TIME - Hours:Minutes      Range = 0-99 hr.:59 min.</p> </li> </ul>
<b>Start segment number</b>	<p>The start segment number designates the number of the first segment. Range = 1 to 11</p>
<b>End segment number</b>	<p>The end segment number designates the number of the last segment, it must be a soak segment (even number). Range = 2 to 12</p>
<b>Recycle number</b>	<p>The recycle number allows the program to recycle a specified number of times from beginning to end. Range = 0 to 99</p>

Contents	Definition
<b>Guaranteed soak</b>	<p>All soak segments can have a deviation value of from 0 to <math>\pm 99</math> (specified by SOK DEV) which guarantees the value for that segment.</p> <p><b>Guaranteed</b> soak deviation values <math>&gt;0</math> guarantee that the soak segment's process variable is within the <math>\pm</math> deviation for the configured soak time. Whenever the <math>\pm</math> deviation is exceeded, soak timing is frozen.</p> <p>There are no guaranteed soaks whenever the deviation value is configured to 0, (that is, soak segments start timing soak duration as soon as the soak setpoint is first reached, regardless of where the process variable remains relative to the soak segment).</p> <p>The soak deviation value is the number in engineering units, above or below the setpoint, outside of which the timer halts. The range is 0 to <math>\pm 99</math>.</p> <p>The decimal location corresponds to input 1 decimal selection.</p>
<b>PV Start</b>	<p>This function determines whether LSP1 or PV is used as the setpoint when the program is initially changed from HOLD to RUN.</p> <p>The selections are:</p> <p>DISABL = When the program is initially changed from HOLD to RUN the present LSP1 value is captured as the default setpoint. If the program is terminated or the power cycled before the program has completed, the LSP1 is used as the control setpoint. The beginning segment uses this value as the initial ramp setpoint.</p> <p>ENABL = When the program is initially changed from HOLD to RUN the present PV value is captured and used as the beginning setpoint value for the ramp segment. If the program is terminated before completion, the setpoint value will revert back to the PV value captured at the initial HOLD to RUN transition. If the power is cycled before program completion, upon power-up the setpoint is set to the PV value at power-up and when the program is restarted that setpoint value is used initially.</p>
<b>Program state</b>	<p>The program state selection determines the program state after completion.</p> <p>The selections are:</p> <ul style="list-style-type: none"> <li>• DIS = program is disabled (so program value changed to DIS)</li> <li>• HOLD = program on hold</li> </ul>
<b>Program termination state</b>	<p>The program termination state function determines the status of the controller upon completion of the program.</p> <p>The selections are:</p> <ul style="list-style-type: none"> <li>• LAST = controls to last setpoint</li> <li>• FSAF = manual mode and failsafe output.</li> </ul>
<b>Reset Program to Beginning</b>	<p>When enabled, this selection allows you to reset the program to the beginning from the keyboard.</p>



### Ramp/soak profile example

Before you perform the actual configuration, we recommend that you draw a Ramp/Soak profile in the space provided on the “*Program Record Sheet*” (Figure 7-2) and fill in the associated information. An example of a Ramp-Soak Profile is shown in Figure 7-1. Start setpoint is at 200 degrees F.

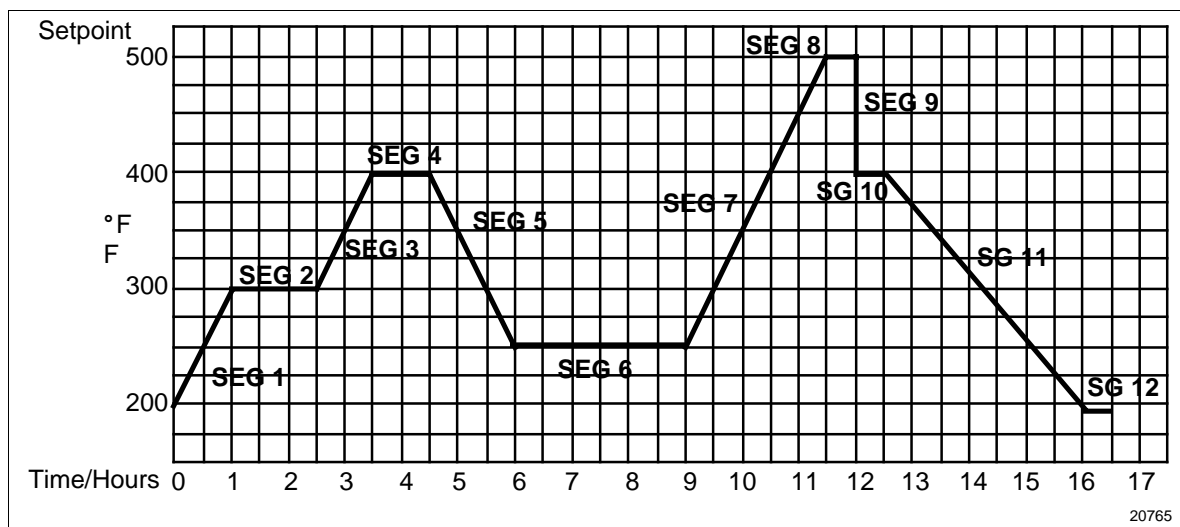

Figure 7-1 Ramp/Soak Profile Example

Ramp/Soak Profile Example

Prompt	Function	Segment	Value	Prompt	Function	Segment	Value
STRSEG	Start Seg.		1	SG4 TI	Soak Time	4	1 hr.
ENDSEG	End Seg.		12	SG5 RP	Ramp Time	5	1 hr.:30 min.
RP UNIT	Engr. Unit for Ramp		TIME	SG6 SP	Soak SP	6	250
PG END	Controller Status		LAST SP	SG6 TI	Soak Time	6	3 hr.:0 min.
STATE	Controller State at end		HOLD	SG7 RP	Ramp Time	7	2 hr.:30 min.
TO BEGIN	Reset SP Program		DIS	SG8 SP	Soak SP	8	500
PVSTRT	Program starts at PV value		DIS	SG8 TI	Soak Time	8	0 hr.:30 min.
RECYCL	Number of Recycles		2	SG9 RP	Ramp Time	9	0
SOKDEV	Deviation Value		0	SG10 SP	Soak SP	10	400
SG1 RP	Ramp Time	1	1 hr.	SG10 TI	Soak Time	10	0 hr.:30 min.
SG2 SP	Soak SP	2	300	SG11 RP	Ramp Time	11	3 hr.:30 min.
SG2 TI	Soak Time	2	1 hr.:30 min.	SG12 SP	Soak SP	12	200
SG3 RP	Ramp Time	3	1 hr.	SG12TI	Soak Time	12	0 hr.:30 min.
SG4 SP	Soak SP	4	400				

**Program record sheet**

Draw your ramp/soak profile on the record sheet shown in Figure 7-2 and fill in the associated information in the blocks provided. This will give you a permanent record of your program and will assist you when entering the Setpoint data.

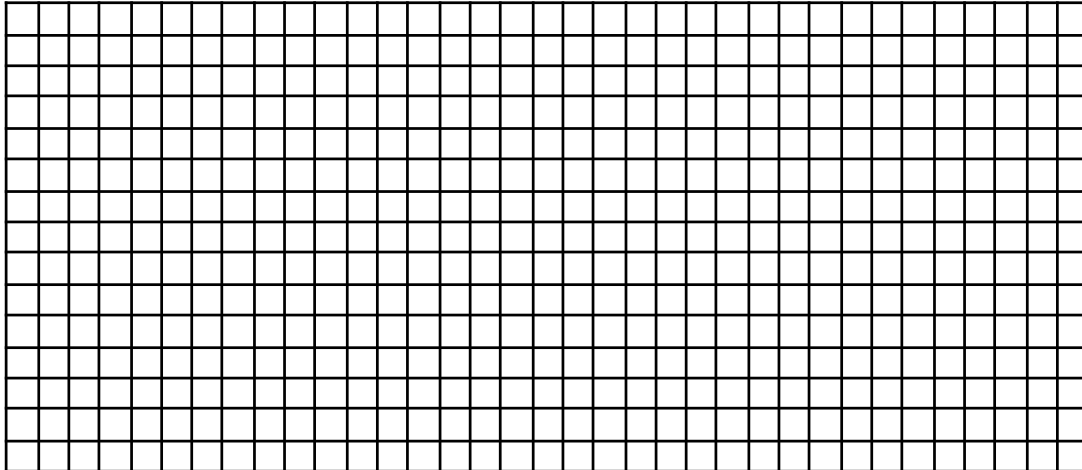

20766

**Figure 7-2 Program Record Sheet**

Prompt	Function	Segment	Value	Prompt	Function	Segment	Value
STRSEG	Start Seg.			SG4 TI	Soak Time	4	
ENDSEG	End Seg.			SG5 RP	Ramp Time	5	
RP UNIT	Engr. Unit for Ramp			SG6 SP	Soak SP	6	
RECYCL	Number of Recycles			SEG6 TI	Soak Time	6	
SOKDEV	Deviation Value			SG7 RP	Ramp Time	7	
PG END	Controller Status			SG8 SP	Soak SP	8	
STATE	Program Controller State			SG8 TI	Soak Time	8	
TO BEGIN	Reset SP Program			SG9 RP	Ramp Time	9	
PVSTRT	Program starts at PV value			SG10 SP	Soak SP	10	
SG1 RP	Ramp Time	1		SG10 TI	Soak Time	10	
SG2 RP	Soak SP	2		SG11RP	Ramp Time	11	
SG2 TI	Soak Time	2		SG12SP	Soak SP	12	
SG3 RP	Ramp Time	3		SG12TI	Soak Time	12	
SG4 SP	Soak SP	4					

## Run/Monitor the program

Prior to running the program, make sure all the “SP PROG” function prompts under the Set Up group “SP RAMP” have been configured with the required data.

“HOLD” appears periodically in the upper display indicating that the program is in the HOLD state.

**ATTENTION** SP Programmer parameter *cannot* be changed during RUN state (must be in HOLD state).

## Run/Monitor functions

Table 7-3 lists all the functions required to run and monitor the program.

**Table 7-3 Run/Monitor Functions**

Function	Press	Result
Set the Local Setpoint	DISPLAY	Upper Display = PV value Lower Display = SP
	▲ or ▼	To set the Local Setpoint value to where you want the program to start out.
Run State	RUN/HOLD	Initiates the setpoint program. “RUN” appears in the upper display indicating that the program is running.
Hold State	RUN/HOLD	Holds the setpoint program. “HOLD” appears in the upper display indicating that the program is in the HOLD state. The setpoint holds at the current setpoint.
External Hold		If Remote Switching (Digital Input Option) is present on your controller, contact closure places the controller in the HOLD state, if the setpoint program is running. The “HOLD” in the upper display will be displayed periodically in lower case. <b>ATTENTION</b> The keyboard takes priority over the external switch for the RUN/HOLD function. Contact reopening runs program.
Viewing the present ramp or soak segment number and time	DISPLAY until you see	Upper Display = PV value Lower Display = XXHH.MM Time remaining in the SEGMENT in hours and minutes. XX = 1 to 12

*continued*

Function	Press	Result
Viewing the number of cycles left in the program	<b>DISPLAY</b> until you see	<i>Upper Display</i> = PV value <i>Lower Display</i> = <b>REC_XX</b> Number of cycles remaining in the setpoint program. X = 0 to 99
End Program		When the final segment is completed, the <b>"RUN"</b> in the upper display either changes to <b>"HOLD"</b> (if configured for HOLD state), or disappears (if configured for disable of setpoint programming). <ul style="list-style-type: none"> <li>The controller either operates at the last setpoint in the program or goes into manual mode/failsafe output.</li> </ul>
Disable Program		See Section 4 – Configuration Group "SPPROG" for details.

## Power outage

**ATTENTION** If power is lost during a program, upon power-up the controller will be in hold and the setpoint value will be the setpoint value prior to the beginning of the setpoint program. The program is placed in hold at the beginning. The mode will be as configured under "PWR UP" in the "CONTROL" group.

## Digital input (remote) operation

Program can be placed in RUN or HOLD state through a remote dry contact connected to optional digital input terminals, as follows:

RUN—contact closure places Program in RUN state, OR

HOLD—contact closure places Program in HOLD state

Opening contact reverts to original state.



## 8 Input Calibration

### 8.1 Overview

#### Introduction

This section describes the field calibration procedures for Input 1 and Input 2.

- Every UDC 2300 controller contains all input actuation ranges which are fully factory-calibrated and ready for configuration to range by the user.
- However, these procedures can be implemented if the factory calibration of the desired range is not within specification.

#### CAUTION

The field calibration will be lost if a change in input type configuration is implemented at a later time. The original factory calibration data remains available for later use after a field calibration is done. See subsection 8.8 if you want to restore factory calibration values.

#### What's in this section?

The following topics are covered in this section.

TOPIC	See Page
8.1 Overview	83
8.2 Minimum and Maximum Range Values	84
8.3 Preliminary Information	85
8.4 Input #1 Set Up Wiring	87
8.5 Input #1 Calibration Procedure	89
0 Input #2 Set Up Wiring	91
8.7 Input #2 Calibration Procedure	92
8.8 Restore Factory Calibration	93



**WARNING—SHOCK HAZARD**



**INPUT CALIBRATION MAY REQUIRE ACCESS TO HAZARDOUS LIVE CIRCUITS, AND SHOULD ONLY BE PERFORMED BY QUALIFIED SERVICE PERSONNEL. MORE THAN ONE SWITCH MAY BE REQUIRED TO DE-ENERGIZE UNIT BEFORE CALIBRATION.**

## Calibration Steps

Use the following steps when calibrating an input.

Step	Action
1	Find the minimum and maximum range values for your PV input range from Table 8-1.
2	Disconnect the field wiring and find out what equipment you will need to calibrate.
3	Wire the calibrating device to your controller according to the set up wiring instructions for your particular input (Subsection 8.4 or 8.6).
4	Follow the calibration procedure given for Input #1 or Input #2 (Subsection 8.5 or 8.7).

## 8.2 Minimum and Maximum Range Values

### Select the Range Values

You should calibrate the controller for the minimum (0 %) and maximum (100 %) range values of your particular controller. If you have a two input controller, calibrate each input separately.

Select the Voltage or Resistance equivalent for 0 % and 100 % range values from Table 8-1. Use these values when calibrating your controller.

**Table 8-1 Voltage and Resistance Equivalents for Input 1 Range Values**

Sensor Type	PV Input Range		Range Values	
	°F	°C	0 %	100 %
<b>Thermocouples</b>				
<b>B</b>	0 to 3300	-18 to 1816	-0.100 mV	13.769 mV
<b>E</b>	-454 to 1832	-270 to 1000	-9.835 mV	76.373 mV
<b>E (low)</b>	-200 to 1100	-129 to 593	-6.472 mV	44.455 mV
<b>J</b>	0 to 1600	-18 to 871	-0.886 mV	50.060 mV
<b>J (low)</b>	20 to 770	-7 to 410	-0.334 mV	22.400 mV
<b>K</b>	0 to 2400	-18 to 1816	-0.692 mV	52.952 mV
<b>K (low)</b>	-20 to 1000	-29 to 538	-1.114 mV	22.255 mV
<b>NiNiMoly (NNM68)</b>	32 to 2500	0 to 1371	0.000 mV	71.330 mV
<b>NiNiMoly (low)</b>	32 to 1260	0 to 682	0.000 mV	31.820 mV
<b>NiMo-NiCo (NM90)</b>	32 to 2500	0 to 1371	0.000 mV	71.773 mV
<b>NiMo-NiCo (low)</b>	32 to 1260	0 to 682	0.000 mV	31.825 mV
<b>Nicrosil Nisil (Nic)</b>	0 to 2372	-18 to 1300	-0.461 mV	47.513 mV
<b>R</b>	0 to 3100	-18 to 1704	-0.090 mV	20.281 mV
<b>S</b>	0 to 3100	-18 to 1704	-0.092 mV	17.998 mV



Sensor Type	PV Input Range		Range Values	
	°F	°C	0 %	100 %
<b>T</b>	-300 to 700	-184 to 371	-5.341 mV	19.097 mV
<b>T (low)</b>	-200 to 500	-129 to 260	-4.149 mV	12.574 mV
<b>W5W26</b>	0 to 4200	-18 to 2315	-0.234 mV	37.075 mV
<b>W5W26 (low)</b>	0 to 2240	-18 to 1227	-0.234 mV	22.283 mV
<b>Honeywell Radamatic</b>  <b>Type RH</b> <b>Type RI</b>	0 to 3400 0 to 3200	-18 to 1871 -18 to 1760	0.00 mV 0.00 mV	57.12 mV 60.08 mV
<b>RTD (IEC Alpha=0.00385)</b>  <b>100 ohms</b> <b>100 ohms (low)</b> <b>200 ohms</b> <b>500 ohms</b>	-300 to 1200 -300 to 300 -300 to 900 -300 to 900	-184 to 649 -184 to 149 -184 to 482 -184 to 482	25.18 ohms 25.18 ohms 50.36 ohms 125.90 ohms	274.96 ohms 156.90 ohms 549.92 ohms 1374.80 ohms
<b>Linear</b>  <b>Milliamps (impedance – 249 Ω)</b>  <b>Millivolts</b>  <b>Volts</b>	4 to 20 mA 0 to 20 mA  0 to 10 mV 0 to 50 mV 0 to 100 mV  1 to 5 Volts 0 to 2 Volts 0 to 5 Volts 0 to 10 Volts		4.00 mA 0.00 mA  0.00 mV 0.00 mV 0.00 mV  1.00 Volts 0.00 Volts 0.00 Volts 0.00 Volts	20.00 mA 20.00 mA  10.00 mV 50.00 mV 100.00 mV  5.00 Volts 2.00 Volts 5.00 Volts 10.00 Volts

### 8.3 Preliminary Information

#### Disconnect the Field Wiring

Tag and disconnect any field wiring connected to the input (#1 or #2) terminals on the rear of the controller.

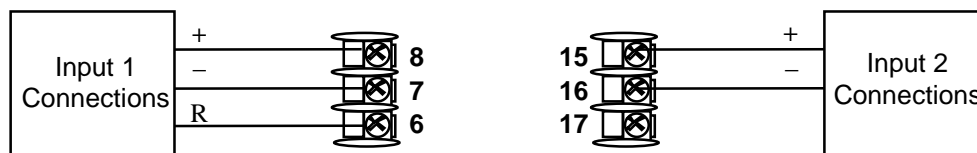

24869

**Figure 8-1 Input 1 and Input 2 Wiring Terminals**

### Check the Jumper for Input 1

Before you calibrate Input #1, check the internal jumper for Input 1 to make sure it is set for the correct input type. The jumper is located at position S101 on the printed wiring board. Figure 2-2 shows the location of the jumper and position selections.

### Check the Jumper for Input 2

Before you calibrate Input #2, check the internal jumper for Input 2 to make sure it is set for the correct input type. The jumper is located at position S201 on the printed wiring board. Figure 2-2 shows the location of the jumper and position selections.

### Equipment Needed

Table 8-2 lists the equipment you will need to calibrate the specific types of inputs that are listed in the table. You will need a screwdriver to connect these devices to your controller.

**Table 8-2 Equipment Needed**

Type of Input	Equipment Needed
Thermocouple Inputs (Ice Bath)	<ul style="list-style-type: none"> <li>• A calibrating device with <math>\pm 0.02\%</math> accuracy for use as a signal source such as a millivolt source.</li> <li>• Thermocouple extension wire that corresponds with the type of thermocouple that will be used with the controller input.</li> <li>• Two insulated copper leads for connecting the thermocouple extension wire from the ice baths to the mV source.</li> <li>• Two containers of crushed ice.</li> </ul>
Thermocouple Inputs (T/C Source)	<ul style="list-style-type: none"> <li>• A calibrating device with <math>\pm 0.02\%</math> accuracy for use as a signal source such as a millivolt source.</li> <li>• Thermocouple extension wire that corresponds with the type of thermocouple that will be used with controller input.</li> </ul>
RTD (Resistance Thermometer Device)	<ul style="list-style-type: none"> <li>• A decade box, with <math>\pm 0.02\%</math> accuracy, capable of providing stepped resistance values over a minimum range of 0 to 1400 ohms with a resolution of 0.1 ohm.</li> <li>• Three insulated copper leads of equal length for connecting the decade box to the controller.</li> </ul>
Milliampere, Millivolt, Volts, and Radiamatic	<ul style="list-style-type: none"> <li>• A calibrating device with <math>\pm 0.02\%</math> accuracy for use as a signal source.</li> <li>• Two insulated copper leads for connecting the calibrator to the controller.</li> <li>• Place current source at zero before switching ON.</li> <li>• Do not switch current sources OFF/ON while connected to the UDC 2300 input.</li> </ul>
<p>ATTENTION: For radiamatic inputs only, set emissivity value to 1.0. See <i>Subsection 4.9</i>– Configuration Set Up prompt INPUT1, function prompt EMISS.</p>	

## 8.4 Input 1 Set Up Wiring

### Thermocouple Inputs Using an Ice Bath

Refer to Figure 8-2 and wire the controller according to the procedure given in Table 8-3. Make sure the jumper at S101 is in the #1 position. See Figure 2-2 Jumper Placements.

**Table 8-3 Set Up Wiring Procedure for Thermocouple Inputs Using an Ice Bath**

Step	Action
1	Connect the copper leads to the calibrator.
2	Connect a length of thermocouple extension wire to the end of each copper lead and insert the junction points into the ice bath.
3	Connect the thermocouple extension wires to the terminals for Input #1. See Figure 8-2.

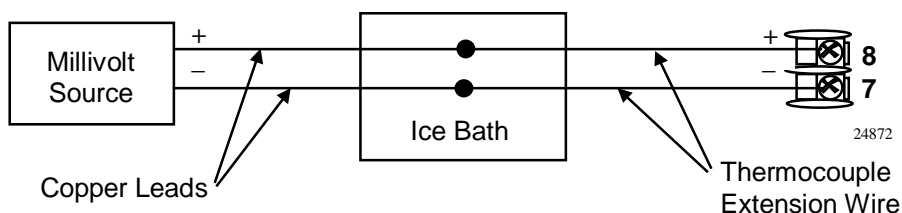

**Figure 8-2 Wiring Connections for Thermocouple Inputs Using an Ice Bath**

### Thermocouple Inputs Using a Thermocouple Source

Refer to Figure 8-3 and wire the controller according to the procedure given in Table 8-4. Make sure the jumper at S101 is in the #1 position. See Figure 2-2 Jumper Placements.

**Table 8-4 Set Up Wiring Procedure for Thermocouple Inputs using Thermocouple Source**

Step	Action
1	Connect the thermocouple extension wires to the terminals for Input #1 as shown in Figure 8-3.

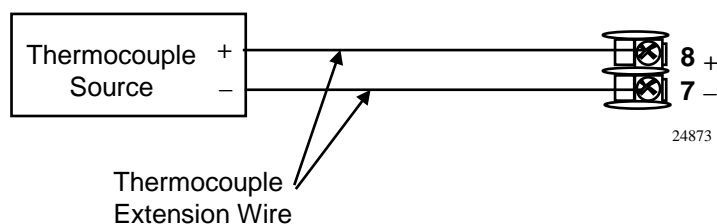

**Figure 8-3 Wiring Connections for Thermocouple Inputs Using Thermocouple Source**

## RTD Inputs

Refer to Figure 8-4 and wire the controller according to the procedure given in Table 8-5. Make sure the jumper at S101 is in the #2 position. See Figure 2-2 Jumper Placements

**Table 8-5 Set Up Wiring Procedure for RTD Inputs**

Step	Action
1	Connect the copper leads from the calibrator to the Input #1 terminals as shown in Figure 8-4.
2	Place current source at zero before switching on.
3	Do not switch current sources ON/OFF while connected to the UDC 2300 input.

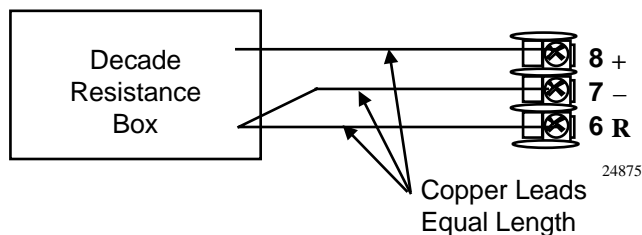

**Figure 8-4 Wiring Connections for RTD (Resistance Thermometer Device)**

## Radiamatic, Millivolts, Milliampere, or Volts

Refer to Figure 8-5 and wire the controller according to the procedure given in Table 8-6. Make sure the jumper at S101 is in the #2 position for, mV, Volts, or the #4 position for mA. See Figure 2-2 Jumper Placements.

**Table 8-6 Set Up Wiring Procedure for Radiamatic, Milliampere, Millivolts, or Volts Inputs (Except 0-10 Volts)**

Step	Action
1	Connect the copper leads from the calibrator to the Input #1 terminals as shown in Figure 8-5.
2	Place current source at zero before switching on.
3	Do not switch current sources ON/OFF while connected to the UDC 2300 input.

### ATTENTION

For radiamatic inputs only, set emissivity value to 1.0. See *Subsection 4.9 – Configuration Set Up* prompt INPUT1, function prompt EMISS.

*Continued next page*

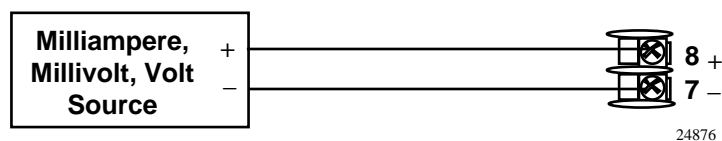

**Figure 8-5 Wiring Connections for Radiamatic, Milliampere, Millivolts, or Volts (Except 0 to 10 Volts)**

## 0 to 10 Volts

Refer to Figure 8-6 and wire the controller according to the procedure given in Table 8-7. Make sure the jumper at S101 is in parked position. See Figure 2-2 Jumper Placements.

**Table 8-7 Set Up Wiring Procedure for 0 to 10 Volts**

Step	Action
1	Connect the copper leads from the calibrator to the Input #1 terminals as shown in Figure 8-6.
2	Place current source at zero before switching on.
3	Do not switch current sources ON/OFF while connected to the UDC 2300 input.

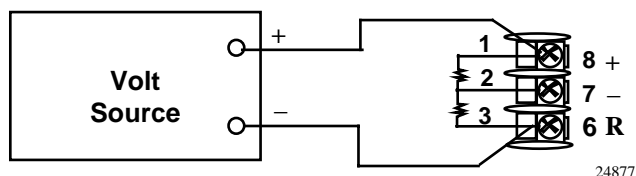

**Figure 8-6 Wiring Connections for 0 to 10 Volts**

## 8.5 Input 1 Calibration Procedure

### Preliminary Steps

- Apply power and allow the controller to warm up for 30 minutes before you calibrate.
- Please read *Subsection 8.4 – Input 1 Set Up Wiring* before beginning the procedure.
- **Make sure you have LOCK set to NONE.** See *Subsection 4.5 - Tuning Set Up Group*.
- See Table 8-1 for Voltage vs. Resistance equivalents or 0 % and 100 % range values.

### CAUTION

For linear inputs, avoid step changes in inputs. Vary smoothly from initial value to final 100 % value.

**Procedure**

The calibration procedure for Input #1 is listed in Table 8-8. The numeric codes are also listed.

**Table 8-8 Input 1 Calibration Procedure (Numeric Code 10000)**

Step	Operation	Press	Result						
1	Enter Calibration Mode	<div style="border: 1px solid black; padding: 2px; display: inline-block;">SET UP</div> until you see	Upper Display = <b>CAL ( - - - - )</b> Lower Display = <b>INPUT1 (10000)</b>						
		<div style="border: 1px solid black; padding: 2px; display: inline-block;">FUNCTION</div>	You will see:  Upper Display = <b>DIS ( 0 )</b> Lower Display = <b>CALIN1 (10001)</b>						
		<div style="border: 1px solid black; padding: 2px; display: inline-block;">▲</div>	The calibration sequence is enabled and you will see:  Upper Display = <b>BEGN ( 1 )</b> Lower Display = <b>CALIN1 (10001)</b>  At the completion of the sequence, the selection automatically reverts to disable.						
2	Calibrate 0 %	<div style="border: 1px solid black; padding: 2px; display: inline-block;">FUNCTION</div>	You will see:  Upper Display = <b>APLY ( 2 )</b> Lower Display = <b>IN1ZRO (10002)</b> <ul style="list-style-type: none"> <li>• Adjust your calibration device to an output signal equal to the 0 % range value for your particular input sensor. See Table 8-1 for Voltage, Degrees, or Resistance equivalents for 0 % range values.</li> <li>• Wait 15 seconds, then go to the next step.</li> </ul>						
3	Calibrate 100 %	<div style="border: 1px solid black; padding: 2px; display: inline-block;">FUNCTION</div>	You will see:  Upper Display = <b>APLY ( 2 )</b> Lower Display = <b>IN1SPN (10003)</b> <ul style="list-style-type: none"> <li>• Adjust your calibration device to an output signal equal to the 100 % range value for your particular input sensor. See Table 8-1 for Voltage, Degrees, or Resistance equivalents for 100 % range values.</li> <li>• Wait 15 seconds, and</li> </ul> <table border="1" style="width: 100%; margin-top: 10px;"> <tr> <td style="width: 50%; padding: 5px;"><b>If ...</b></td> <td style="width: 50%; padding: 5px;"><b>Then ...</b></td> </tr> <tr> <td style="padding: 5px;">you are calibrating a Thermocouple input</td> <td style="padding: 5px;">go to step 4</td> </tr> <tr> <td style="padding: 5px;">you are calibrating other than a Thermocouple input</td> <td style="padding: 5px;">go to step 5</td> </tr> </table>	<b>If ...</b>	<b>Then ...</b>	you are calibrating a Thermocouple input	go to step 4	you are calibrating other than a Thermocouple input	go to step 5
<b>If ...</b>	<b>Then ...</b>								
you are calibrating a Thermocouple input	go to step 4								
you are calibrating other than a Thermocouple input	go to step 5								

*Continued next page*

Step	Operation	Press	Result
4	Check the Cold Junction Temperature	FUNCTION	<p>The calculations for zero and span are now stored and you will see:</p> <p><i>Upper Display</i> = The cold junction temperature at the rear terminals  <i>Lower Display</i> = <b>CJTEMP (10004)</b></p> <p>The value in the upper display is in tenths of a degree. It is the current reading of the temperature as measured at the thermocouple terminals and recognized by the controller. You can change this value, if it is in error, using the [▲] [▼] keys.</p> <p>NOTE: The accuracy of the controller is directly affected by the accuracy of this value. Change this value only if the zero and span calibration procedures did not bring the controller within the specified accuracy requirements.</p>
5	Exit the Calibration Mode	FUNCTION then DISPLAY	<p>The controller stores the calibration constants and exits the calibration mode.</p>

## 8.6 Input 2 Set Up Wiring

### 0 to 20 mA or 4 to 20 mA Inputs

- Use the copper leads and connect the calibrator to the rear terminals of Input #2 (see Figure 8-7).
- Make sure jumper at S201 is set for mA (position 1). See Figure 2-2 Jumper Placements.

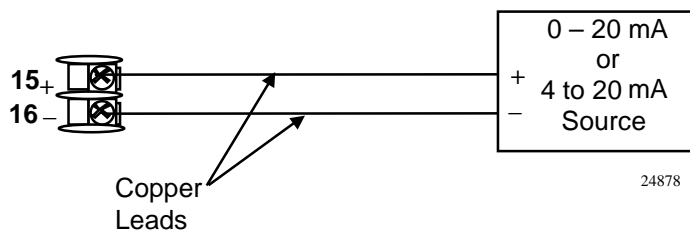
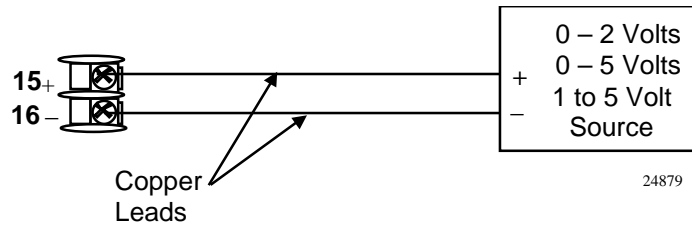

Figure 8-7 Wiring Connections for 4 to 20 mA Input – Input 2

### 0 to 2 Volts, 0 to 5 Volts, or 1 to 5 Volt Inputs

- Use the copper leads and connect the calibrator to the rear terminals of Input #2 (see Figure 8-8).
- Make sure the jumper of S201 is set for Volts (position 2). See Figure 2-2 Jumper Placements.



**Figure 8-8 Wiring Connections for 1 to 5 Volt Input – Input 2**

## 8.7 Input 2 Calibration Procedure

### Preliminary Steps

- Apply power and allow the controller to warm up for 30 minutes before you calibrate.
- Please read *Subsection 8.6 – Input 2 Set Up Wiring* before beginning the procedure.
- **Make sure you have LOCK set to NONE. See *Subsection 4.5 - Tuning Set Up Group*.**

*Continued next page*



## Procedure

The calibration procedure for Input #2 is listed in Table 8-9. The numeric codes are also listed.

**Table 8-9 Input 2 Calibration Procedure (Numeric Code 20000)**

Step	Operation	Press	Result
1	Enter Calibration Mode	<input type="button" value="SET UP"/>	<i>Upper Display = CAL ( - - - - )</i> <i>Lower Display = INPUT2 (20000)</i>
		until you see	
		<input type="button" value="FUNCTION"/>	You will see: <i>Upper Display = DIS ( 0 )</i> <i>Lower Display = CALIN2 (20001)</i>
		<input type="button" value="▲"/>	You will see: <i>Upper Display = BEGN ( 1 )</i> <i>Lower Display = CALIN2 (20001)</i>
2	Calibrate 0 %	<input type="button" value="FUNCTION"/>	You will see: <i>Upper Display = APLY ( 2 )</i> <i>Lower Display = INZZRO (20002)</i>
			<ul style="list-style-type: none"> <li>Adjust your calibration device to an output signal equal to the 0 % range value for your particular input sensor.</li> <li>Wait 15 seconds, then go to the next step.</li> </ul>
3	Calibrate 100 %	<input type="button" value="FUNCTION"/>	You will see: <i>Upper Display = APLY ( 2 )</i> <i>Lower Display = IN2SPN (20003)</i>
			<ul style="list-style-type: none"> <li>Adjust your calibration device to an output signal equal to the 100 % range value for your particular input sensor.</li> <li>Wait 15 seconds, then go to the next step.</li> </ul>
4	Exit the Calibration Mode	<input type="button" value="FUNCTION"/>	The controller stores the calibration constants.
		<input type="button" value="DISPLAY"/>	To store the calibration constants and exit the calibration mode.

## 8.8 Restore Factory Calibration

### Introduction

The factory calibration constants for all the input actuation types that can be used with the controller are stored in its nonvolatile memory. Thus, you can quickly restore the “Factory Calibration” for a given input actuation type by simply changing the actuation type to another type and then changing it back to the original type.

*Refer to Table 8-10 Restore Factory Calibration for procedure.*

**ATTENTION:** A restored factory calibration overwrites any previous field calibration done for the input and may change the High and Low Range Limits.

Be sure to protect any field calibration from accidental overwrites by configuring the appropriate LOCKOUT selection after calibration.

See the *Section 4 - Configuration* for specific instructions to set the lockout.

**Table 8-10 Restore Factory Calibration**

Step	Operation	Press	Result
1	Set LOCKOUT to NONE	SET UP	until you see: <i>Upper Display</i> = <b>SET UP</b> <i>Lower Display</i> = <b>TUNING</b>
		FUNCTION	Until you see: <i>Upper Display</i> = <b>one of the following:</b> <b>NONE</b> – all parameters are read/write <b>CAL</b> – all parameters are read/write except Calibration <b>CONF</b> – configuration parameters are Read Only; no writes permitted <b>VIEW</b> – Tuning and Setpoint Ramp parameters are read/write. No other parameters can be viewed. <b>ALL</b> – Tuning and Setpoint Ramp parameters are available for read only. No other parameters can be viewed. <i>Lower Display</i> = <b>LOCK</b>
		[▲] [▼]	Until <b>NONE</b> is in the upper display
2	Enter INPUT 1 Setup Group	SET UP	until you see: <i>Upper Display</i> = <b>SET UP</b> <i>Lower Display</i> = <b>INPUT 1 or 2</b>
		FUNCTION	until you see: <i>Upper Display</i> = the current selection <i>Lower Display</i> = <b>INxTYP</b>
		[▲] [▼]	to change the current selection to another selection
3	Scroll through Functions	FUNCTION	until the lower display rolls through the rest of the functions and returns to: <i>Upper Display</i> = the new selection <i>Lower Display</i> = <b>INxTYP</b>
		[▲] [▼]	until you change the input selection in the upper display back to the proper selection. You will see: <i>Upper Display</i> = Original Input Selection that matches your type of sensor. <i>Lower Display</i> = <b>INxTYP</b>
4	Return to Normal Operation	DISPLAY	to return to Normal operating mode. The factory calibration will be restored. If the problem is not corrected, contact the Honeywell Technical Assistance Center. 1-800-423-9883 USA and Canada

## 9 Output Calibration

### 9.1 Overview

#### Introduction

This section describes the field calibration procedures for the following types of outputs:

- Current Proportional Output
- Auxiliary Output
- Motor Travel Time Setting for Three Position Step

#### What's in this section?

The following topics are covered in this section.

TOPIC	See Page
9.1 Overview	95
0 Current Proportional Output Calibration	96
9.3 Auxiliary Output Calibration	98
9.4 Three Position Step Control Output Calibration	100



**WARNING—SHOCK HAZARD**



**OUTPUT CALIBRATION MAY REQUIRE ACCESS TO HAZARDOUS LIVE CIRCUITS, AND SHOULD ONLY BE PERFORMED BY QUALIFIED SERVICE PERSONNEL. MORE THAN ONE SWITCH MAY BE REQUIRED TO DE-ENERGIZE UNIT BEFORE CALIBRATION.**

## 9.2 Current Proportional Output Calibration

### Introduction

Calibrate the controller so that the output provides the proper amount of current over the desired range. The controller can provide an output current range of from 0 to 21 milliamperes and can be calibrated at 4 mA for 0 % of output and 20 mA for 100 % of output, or any other values between 0 mA and 21 mA.

### Equipment Needed

You will need a standard shop type milliammeter, with whatever accuracy is required, capable of measuring 0 to 20 milliamps.

### Calibrator Connections

Refer to Figure 9-1 and wire the controller according to the procedure given in Table 9-1.

**Table 9-1 Set Up Wiring Procedure for Current Proportional Output**

Step	Action
1	Apply power and allow the controller to warm up 30 minutes before you calibrate.
2	Set LOCK in the Tuning Set Up group to NONE.
3	Tag and disconnect the field wiring, at the rear of the controller, from terminals 4 (-) and 5 (+). See Figure 9-1.
4	Connect a milliammeter across these terminals.

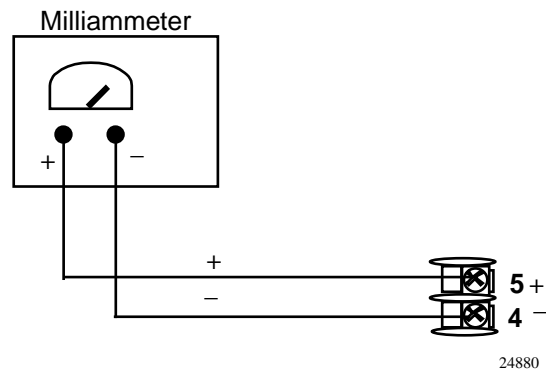

**Figure 9-1 Wiring Connections for Calibrating Current Proportional Output**

**Procedure**

The procedure for calibrating the Current Proportional Output is listed in Table 9-2. The numeric codes are also listed. Make sure LOCK in the Tuning Set Up group is set to NONE. (See Subsection 4.5 – Tuning Set Up Group.)

**Table 9-2 Current Proportional Output Calibration Procedure  
(Numeric Code 30000)**

Step	Operation	Press	Result
1	Enter Calibration Mode	<div style="border: 1px solid black; padding: 2px; display: inline-block;">SET UP</div> until you see	Upper Display = <b>CAL ( - - - - )</b> Lower Display = <b>CURRENT (30000)</b>
2	Calibrate 0 %	<div style="border: 1px solid black; padding: 2px; display: inline-block;">FUNCTION</div>  [▲] [▼]	You will see:  Upper Display = A Value Lower Display = <b>ZROVAL (30001)</b>  Until the desired 0 % output is read on the milliammeter, use the values shown below depending on the action of your controller. <ul style="list-style-type: none"> <li>• 0 mA For 0 to 20 mA Direct Action</li> <li>• 4 mA For 4 to 20 mA Direct Action</li> <li>• 20 mA For 4 to 20 mA Reverse Action or 0 to 20 mA Reverse Action</li> </ul>
3	Calibrate 100 %	<div style="border: 1px solid black; padding: 2px; display: inline-block;">FUNCTION</div>  [▲] [▼]	This stores the 0 % value and you will see:  Upper Display = A Value Lower Display = <b>SPNVAL (30002)</b>  Until the desired 100 % output is read on the milliammeter, use the values shown below depending on the action of your controller. <ul style="list-style-type: none"> <li>• 20 mA For 0 to 20 mA Direct Action</li> <li>• 20 mA For 4 to 20 mA Direct Action</li> <li>• 4 mA For 4 to 20 mA Reverse Action</li> <li>• 0 mA For 0 to 20 mA Reverse Action</li> </ul>
4	Exit the Calibration Mode	<div style="border: 1px solid black; padding: 2px; display: inline-block;">FUNCTION</div>  <div style="border: 1px solid black; padding: 2px; display: inline-block;">DISPLAY</div>	The controller stores the span value.  To exit the calibration mode.

## 9.3 Auxiliary Output Calibration

### Introduction

Calibrate the controller so that the auxiliary output provides the proper amount of current over the desired range. The controller can provide an auxiliary current output range of from 0 mA to 20 mA and can be calibrated at 4 mA for 0 % of output and 20 mA for 100 % of output or any other values between 0 mA and 21 mA.

### Equipment Needed

You will need a calibrating device with whatever accuracy is required, capable of measuring 0 to 20 mA.

### Calibrator Connections

Refer to Figure 9-2 and wire the controller according to the procedure given in Table 9-3.

**Table 9-3 Set Up Wiring Procedure for Auxiliary Output**

Step	Action
1	Apply power and allow the controller to warm up 30 minutes before you calibrate.
2	<b>Set LOCK in the Tuning Set Up group to NONE.</b>
3	Tag and disconnect the field wiring, at the rear of the controller, from terminals 13 (+) and 14 (-). See Figure 9-2.
4	Connect a milliammeter across these terminals.

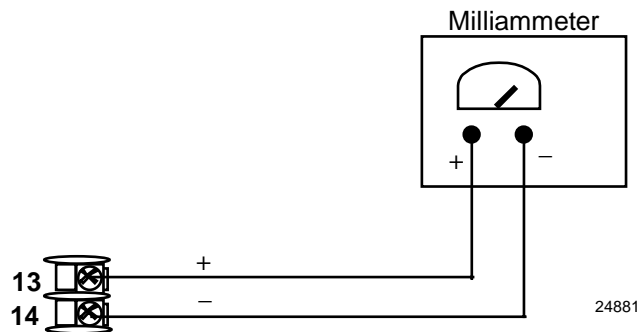

**Figure 9-2 Wiring Connections for Calibrating Auxiliary Output**

**Procedure**

The procedure for calibrating the auxiliary output is listed in Table 9-4. The numeric codes are also listed.

Make sure “LOCK” in the Tuning Set Up group is set to “NONE” (see *Subsection 4.5*).

**Table 9-4 Auxiliary Output Calibration Procedure  
(Numeric Code 50000)**

Step	Operation	Press	Result
1	Enter Calibration Mode	<div style="border: 1px solid black; padding: 2px; display: inline-block;">SET UP</div> until you see	Upper Display = <b>CAL ( - - - - )</b> Lower Display = <b>AUXOUT (50000)</b>
2	Calibrate 0 %	<div style="border: 1px solid black; padding: 2px; display: inline-block;">FUNCTION</div>  <div style="border: 1px solid black; padding: 2px; display: inline-block;">[▲] [▼]</div>	You will see: Upper Display = A Value Lower Display = <b>ZROVAL (50001)</b>  until the desired 0 % output is read on the milliammeter, use the values shown below depending on the action of your controller.
3	Calibrate 100 %	<div style="border: 1px solid black; padding: 2px; display: inline-block;">FUNCTION</div>  <div style="border: 1px solid black; padding: 2px; display: inline-block;">[▲] [▼]</div>	To store the 0 % value you will see: Upper Display = A Value Lower Display = <b>SPNVAL (50002)</b>  until the desired 100 % output is read on the milliammeter.
4	Exit the Calibration Mode	<div style="border: 1px solid black; padding: 2px; display: inline-block;">FUNCTION</div>  <div style="border: 1px solid black; padding: 2px; display: inline-block;">DISPLAY</div>	The controller stores the span value.  To exit the calibration mode.

## 9.4 Three Position Step Output Calibration

### Three position step control

*Three Position Step Control Output Models **without** Motor Position Indication*

*(Model Numbers 230B-EE-XX-X0, DC230B-AA-XX-X0)*

This model only requires that the “Motor Time” be entered as shown in the calibration procedure.

### Equipment needed

None.

### Connections

Apply power and allow the controller to warm up 30 minutes before you calibrate. Leave all field wiring connected to the rear terminals.

### Procedure

The procedure for calibrating the 3 Position Step control output is listed in Table 9-5. The numeric codes are also listed. Make sure LOCKOUT in Tuning Set Up group is set to NONE. See *Subsection 4.5*.

**ATTENTION** These prompts *only* appear when “TPSC” is selected in the algorithm group function prompt.

**Table 9-5 3 Position Step Output Calibration Procedure  
(Numeric Code 40000)**

Step	Description	Press	Action
1	Enter Calibration Mode	<input type="button" value="SET UP"/>	Until you see <i>Upper Display = CAL ( - - - - )</i> <i>Lower Display = TPSC (40000)</i>
2	Set Motor Traverse Time  NOTE: This is the time it takes the motor to travel from 0 % to 100 %.	<input type="button" value="FUNCTION"/>	Until you see <i>Upper Display = a value</i> <i>Lower Display = MTR TI (40001)</i>
		<input type="button" value="▲"/> <input type="button" value="▼"/>	until the proper motor stroke time is reached (see the motor specs or measure the time)  Range of setting = 5 to 1800 Seconds
3	Exit the Calibration Mode	<input type="button" value="FUNCTION"/>	The controller will store the 100 % value.
		<input type="button" value="DISPLAY"/>	To exit the calibration mode.
		Or <input type="button" value="SET UP"/>	



# 10 Troubleshooting/Service

## 10.1 Overview

### Introduction

Instrument performance can be adversely affected by installation and application problems as well as by hardware problems. We recommend that you investigate the problems in the following order:

- installation related problems
- application related problems
- hardware and software related problems

and use the information presented in this section to solve them.

### What's in this section?

The following topics are covered in this section.

TOPIC		See Page
10.1	Overview	101
10.2	Troubleshooting Aids <ul style="list-style-type: none"> <li>• Overall Error Messages</li> <li>• Controller Failure Symptoms</li> <li>• Customer Support</li> <li>• Determining the Software Version Number</li> </ul>	102
10.3	Power-up Tests	104
10.4	Status Tests	104
10.5	Background Tests	105
10.6	Controller Failure Symptoms	107
10.7	Troubleshooting Procedures <ul style="list-style-type: none"> <li>• Power Failure</li> <li>• Current Proportional Output Failure</li> <li>• Time Proportional Output Failure</li> <li>• Time/Current - Current/Time Proportional Output Failure</li> <li>• Alarm Relay Output Failure</li> <li>• Keyboard Failure</li> </ul>	108

## Installation related problems

Read the Installation section in this manual to make sure the UDC 2300 has been properly installed. The installation section provides information on protection against electrical noise, connecting external equipment to the controller, and shielding and routing external wiring.

**ATTENTION** System noise induced into the controller will result in diagnostic error messages recurring. If the diagnostic error messages can be cleared, it indicates a “soft” failure and is probably noise related.

If system noise is suspected, completely isolate the controller from all field wiring. Use calibration sources to simulate PV and check all controller functions; i.e. Gain, Rate, Reset, Output, Alarms, etc.

## Application related problems

Review the application of the controller; then, if necessary, direct your questions to the local sales office.

## Hardware and software related problems

Use the troubleshooting error message prompts and controller failure symptoms to identify typical failures which may occur in the controller. Follow the troubleshooting procedures to correct them.

## 10.2 Troubleshooting Aids

### Overall error messages

An error message can occur

- at power-up, see Subsection 10.3.
- when the Status Tests are requested. See Subsection 10.4.
- during continuous background tests while in normal operation. See Subsection 10.5.

### Controller failure symptoms

Other failures may occur that deal with the Power, Output, or Alarms. Refer to the controller failure symptom in Table 10-4 to determine what is wrong and the troubleshooting procedures to use to correct the problem.

### Check installation

If a set of symptoms still persists, refer to *Section 2 - Installation* and ensure proper installation and proper use of the controller in the system.

## Customer support

If you cannot solve the problem using the troubleshooting procedures listed in this section, you can get **technical assistance** by dialing 1-800-423-9883 USA and Canada.

An engineer will discuss your problem with you. **Please have your complete model number, serial number, and Software version available.** The model and serial numbers can be found on the chassis nameplate. The software version can be viewed under Setup Group “Status.” See Table 10-1.

If it is determined that a hardware problem exists, a replacement controller or part will be shipped with instructions for returning the defective unit.

Do not return your controller without authorization from Honeywell’s Technical Assistance Center or until the replacement has been received.

For a list of frequently asked questions and their answers, dial Honeywell’s **Faxback** 24 hour Service:

1-888-423-9883 USA

Or check out Honeywell’s **web site** at <http://www.honeywell.com/sensing>.

## Determining the software version

Table 10-1 lists the procedure for identifying the software version number.

**Table 10-1 Procedure for Identifying the Software Version**

Step	Operation	Press	Result
1	Select STATUS Set Up Group	<b>SET UP</b>	<i>Upper Display = READ</i> <i>Lower Display = STATUS (1200)</i>
2	Read the software version	<b>FUNCTION</b>	You will see: <i>Upper Display = Software version number</i> <b>A1xx Basic Controller and Indicator</b> <b>A2xx Limit Controller</b>  <i>Lower Display = VERSON (1201)</i>  Please give this number to the Customer Support person. It will indicate which version of UDC 2300 you have and help them determine a solution to your problem.

## 10.3 Power-up Tests

### What happens at power-up

When power is applied, the controller will run three diagnostic tests. After these tests are completed, “TEST DONE” is displayed.

### Test Failures

If one or more of these tests fail, the controller will go to the Failsafe Manual Mode, and FAILSF will flash in the lower display and a message indicating which test failed will appear in the lower display. Then, “DONE” will appear in the lower display.

### 3 position step test failures

For controller configured for 3 Position Step control with motor position indication and Auto-cal has never been done, a prompt CAL MTR will appear suggesting that the controller be calibrated. *Refer to Subsection 9.4 - Three Position Step Output Calibration.*

## 10.4 Status Tests

### Introduction

When required, the results of these tests can be checked to determine the reason the controller has gone to Failsafe.

### How to check the status tests

The procedure in Table 10-2 tells you how to display the results of the status tests.

**Table 10-2 Procedure for Displaying the Status Test (Numeric Code 1200) Results**

Step	Operation	Press	Result
1	Select STATUS Set Up Group	SET UP	Upper Display = READ Lower Display = STATUS (1200)
2	Read the test results	FUNCTION	You will see:  Upper Display = NO ( 0 ) or YES ( 1 ) YES indicates a failure Lower Display = FAILSF ( 1202)
		FUNCTION	Upper Display = PASS ( 0 ) or FAIL ( 1 ) Lower Display = TEST (1203)

## 10.5 Background Tests

### Introduction

The UDC 2300 performs ongoing background tests to verify data and memory integrity. If there is a malfunction, an error message will be displayed (blinking) in the lower display.

In the case of simultaneous malfunctions, the messages will appear in sequence in the lower display. Table 10-3 lists these background tests, the reason for their failure, and how to correct the problem.

**Table 10-3 Background Tests**

Lower Display	Reason for Failure	How to Correct the Problem
<b>E FAIL</b>	Unable to write to non-volatile memory. Anytime you change a parameter and it is not accepted, you will see E FAIL.	<ol style="list-style-type: none"> <li>1. Check the accuracy of the parameter and re-enter.</li> <li>2. Try to change something in configuration.</li> <li>3. Run through Read STATUS tests to re-write to EEPROM.</li> </ol>
<b>FAILSF</b>	This error message shows whenever the controller goes into a failsafe mode of operation. This will happen if: <ul style="list-style-type: none"> <li>• RAM test failed</li> <li>• Configuration test failed</li> <li>• Calibration test failed</li> <li>• Burnout configured for none and the input failed.</li> </ul>	<ol style="list-style-type: none"> <li>1. Run through STATUS check to determine the reason for the failure.</li> <li>2. Press the <b>SET UP</b> key until STATUS appears in the lower display.</li> <li>3. Press the <b>FUNCTION</b> key to see whether the tests pass or fail, then run through the STATUS codes a second time to see if the error cleared.</li> </ol>
<b>IN1RNG</b>	Input 1 out of range. The process input is outside the range limits.	<ol style="list-style-type: none"> <li>1. Make sure the range and actuation are configured properly.</li> <li>2. Check the input source.</li> <li>3. Restore the factory calibration. (See <i>Subsection 8.8.</i>)</li> <li>4. Field calibrate. See <i>Section 8 - Input Calibration.</i></li> </ol>
<b>IN1_FL</b>	Two consecutive failures of input 1 integration; i.e., cannot make analog to digital conversion. This will happen if: <ul style="list-style-type: none"> <li>• Upscale or Downscale burnout is selected</li> <li>• Input not configured correctly</li> </ul>	<ol style="list-style-type: none"> <li>1. Make sure the actuation is configured correctly. See <i>Section 4 - Configuration.</i></li> <li>2. Make sure the input is correct.</li> <li>3. Check for gross over-ranging. Check S101 jumper position. See Figure 2-2 Jumper Placements.</li> <li>4. Restore factory calibration. See <i>Subsection 8.8.</i></li> </ol>
<b>IN2RNG</b>	Input 2 out of range. The remote input is outside the range limits.	Same as IN1RNG above.

Lower Display	Reason for Failure	How to Correct the Problem
<b>IN2_FL</b>	Two consecutive failures of input 2 integration. i.e., cannot make analog to digital conversion.	Same as IN1FL above.
<b>CNFERR</b>	<ul style="list-style-type: none"> <li>• PV low limit is &gt; PV high limit</li> <li>• SP low limit is &gt; SP high limit</li> <li>• Output low limit &gt; Output high limit</li> </ul>	1. Check the configuration for each item and reconfigure if necessary.
<b>PV LIM</b>	PV out of range. $PV = INP1 \times RATIO1 + INP1 \text{ BIAS}$	1. Make sure the input signal is correct. 2. Make sure the Ratio and Bias settings are correct. 3. Recheck the calibration. Use Bias of 0.0
<b>RV LIM</b>	The result of the formula shown below is beyond the range of the remote variable.  $RV = INP2 \times RATIO + BIAS$	1. Make sure the input signal is correct. 2. Make sure the Ratio2 and Bias2 settings are correct. 3. Recheck the calibration. Use a Ratio2 of 1.0 and a Bias2 of 0.0.
<b>SEGERR</b>	Setpoint Program start segment number is less than ending segment number.	1. Check SP Program configuration, subsection 4.6 Set up Group SPPROG function prompts "STRSEG" and "ENDSEG".

## 10.6 Controller Failure Symptoms

### Introduction

In addition to the error message prompts, there are failure symptoms that can be identified by noting how the controller displays and indicators are reacting.

### Symptoms

Compare your symptoms with those shown in Table 10-4.

**Table 10-4 Controller Failure Symptoms**

Upper Display	Lower Display	Indicators	Controller Output	Probable Cause	Trouble-shooting Procedure
Blank	Blank	Off	None	Power Failure	1
OK	Displayed Output disagrees with Controller Output	OK	Controller Output disagrees with Displayed Output	Current Proportional Output	2
OK		OK		Time Proportional Output	3
OK		OK		Current/Time Proportional Output	4
OK		OK		Current/Time Proportional Output	5
OK	OK	OK	External Alarm function does not operate properly	Malfunction in alarm output	6
Display does not function when a key is pressed				Keyboard Malfunction	7

### Other symptoms

If a set of symptoms or prompts other than the one you started with appears while troubleshooting, re-evaluate the symptoms. This may lead to a different troubleshooting procedure.

If the symptom still persists, refer to the installation section in this manual to ensure proper installation and proper use of the controller in your system.

## 10.7 Troubleshooting Procedures

### Introduction

The troubleshooting procedures are listed in numerical order as they appear in Table 10-4. Each procedure lists what to do if you have that particular failure and how to do it or where to find the data needed to accomplish the task.

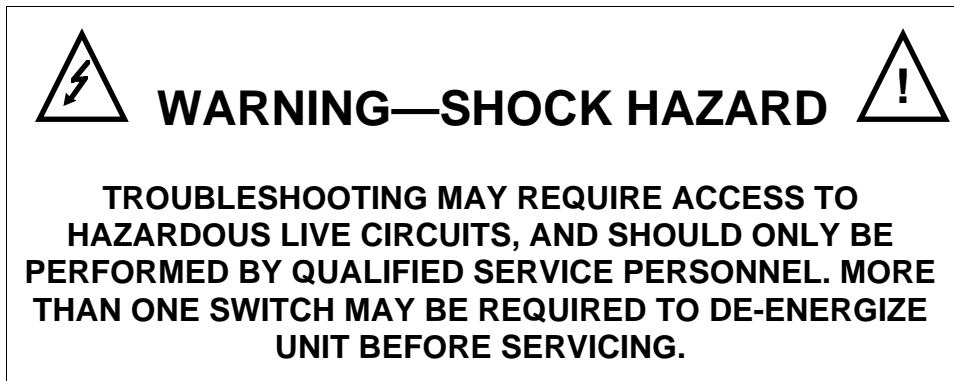

### Equipment needed

You will need the following equipment in order to troubleshoot the symptoms listed in the tables that follow:

- DC Milliammeter – mA<sub>dc</sub>
- Calibration sources – T/C, mV, Volt, etc.
- Voltmeter



**Procedure #1**

Table 10-5 explains how to troubleshoot power failure symptoms.

**Table 10-5 Troubleshooting Power Failure Symptoms**

Step	What to do	How to do it
1	Check the AC line voltage.	Use a voltmeter to measure the AC voltage across terminals L1 and L2 on the rear terminal panel of the controller.  Check the earth ground connection.
2	Make sure the chassis plugs into the rear of the case properly.	Withdraw the chassis and visually inspect the controller board and the inside of the case.
3	Check the system for Brown-outs, heavy load switching, etc., and conformance to installation instructions.	Refer to <i>Section 2 - Installation</i> .
4	Change Main board.	Installation instructions supplied with new board.

**Procedure #2**

Table 10-6 explains how to troubleshoot Current Proportional Output failure symptoms.

**Table 10-6 Troubleshooting Current Proportional Output Failure**

Step	What to do	How to do it
1	Make sure the controller is configured for Current output.	Make Algorithm Set Up group function prompt OUT ALG = CUR.  Refer to <i>Section 4 - Configuration</i> .
2	Check the field wiring.	Output impedance must be less than or equal to 750 ohms.
3	Check the output.	Put the controller into Manual mode and change the output from 0 % to 100 % (4-20 mA). Use a DC milliammeter at the rear terminals to verify the output.
4	Recalibrate the Current Proportional output.	Refer to <i>Section 9 - Output Calibration</i> for details.
5	Change Main board.	Installation instructions provided with new board.
6	Change Controller	

**Procedure #3**

Table 10-7 explains how to troubleshoot Time Proportional Output failure.

**Table 10-7 Troubleshooting Time Proportional Output Failure**

Step	What to do	How to do it
1	Make sure the controller is configured for Time Proportional output.	Make Output Algorithm Set Up group function prompt OUTALG = RLY or RLYD.  Refer to <i>Section 4 - Configuration</i> .
2	Check the field wiring.	Make sure the NO or NC contact selection is correct.  Refer to <i>Section 2 - Installation</i> for details.
3	Check the output (control) relay jumper position.	Refer to <i>Section 2 – Installation</i> for relay jumper placement and relay contact information.
4	Check the output.	Put the controller into Manual mode. Vary the output above and below the present value. Observe OUT indicator on the operator interface. Contact should change state. 1E 0 % open, 100 % closed.
5	Check relay.	Change relay.
6	Change Main board.	Installation instructions supplied with the new board.

---

**Procedure #4**

Table 10-8 explains how to troubleshoot Current/Time or Time/Current Proportional Output failure.

**Table 10-8 Troubleshooting Current/Time or Time/Current Proportional Output Failure**

Step	What to do	How to do it
1	Make sure the controller is configured for Time/Current or Current/Time Proportional output.	Make Output Algorithm Set Up group function prompt OUT ALG = TCUR or CURT.  Refer to <i>Section 4 – Configuration</i> .
2	Check the field wiring.	Make sure the NO or NC contact wiring selection is correct.  Refer to <i>Section 2 - Installation</i> for details.
3	<ol style="list-style-type: none"> <li>1. Check the output (control) relays jump position.</li> <li>2. Check the relay output.</li> </ol>	<ol style="list-style-type: none"> <li>1. Refer to <i>Section 2 – Installation</i> for relay jumper placement and relay contact information.</li> <li>2. Put the controller into Manual mode. Vary the output above and below the present value. Observe OT indicator on the operator interface.</li> </ol>
4	Check the Current Proportional Output.	Put the controller into Manual mode and change the output from 0 % to 100 % (4-20 mA). Use a DC milliammeter at the rear terminals to verify the output.
5	Recalibrate the controller.	Refer to <i>Section 9 - Output Calibration</i> for details.
6	Change Main board.	Installation instructions supplied with new board.

**Procedure #5**

Table 10-9 explains how to troubleshoot Alarm Relay Output failure.

**Table 10-9 Troubleshooting Alarm Relay Output Failure**

Step	What to do	How to do it
1	Check the alarm configuration data. If it is correct, check the field wiring.	Reconfigure if necessary. Refer to <i>Section 4 - Configuration</i> for details.
2	Check that the applicable alarm relay actuates properly depending on what you have set at prompt AxSxTYPE.  If it does, check the field wiring.	If the alarm type is set for PV, place the controller in manual mode. Vary the input to raise and lower the PV around the setpoint. Listen for a click from the relay as the PV moves in either direction and note that the proper ALM1 or ALM2 is lit.  EXAMPLE: If the alarm is set for MAN, put the controller into manual mode. The alarm light is ON. Put the controller into automatic mode and the alarm light is OFF.
3	Check the contacts.	Make sure the NO or NC contact wiring is correct.  Refer to <i>Section 2 - Installation</i> for relay jumper placement and relay contact information.
4	Change Main board.	Installation instructions supplied with new board.

---

**Procedure #6**

Table 10-10 explains how to troubleshoot a Keyboard failure.

**Table 10-10 Troubleshooting a Keyboard Failure**

Step	What to do	How to do it
1	Make sure the keyboard is connected properly.	Withdraw the chassis from the case and visually inspect the connection.
2	Controller Keyboard or specific keys may be LOCKED OUT via the security code.	Use your four-digit security code number to change the lockout level. Refer to <i>Section 4 – Configuration</i> .  <b>ATTENTION</b> Using “1000” as a security code number will override the 4-digit code previously entered.
3	Replace the display/keyboard if any keys are not functioning.	Installation instructions supplied with new display/keyboard.



## 11 Parts List

### 11.1 Exploded View

#### Introduction

Figure 11-1 is an exploded view of the UDC 2300 Controller. Each part is labeled with a key number. The part numbers are listed by key number in Table 11-1. Parts not shown are listed in Table 11-2.

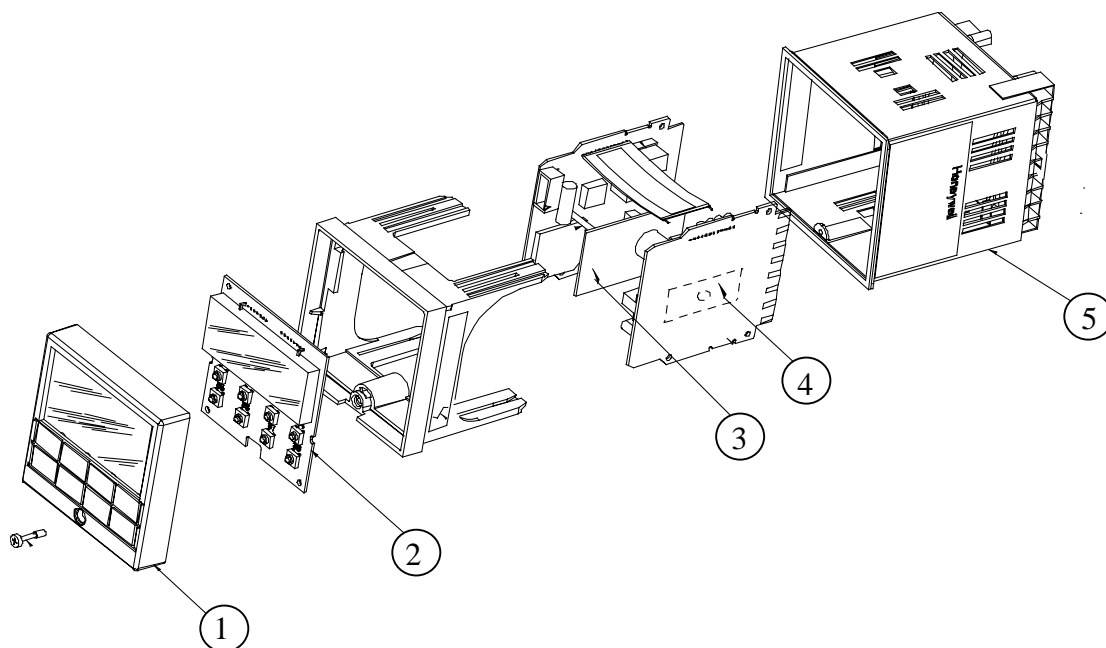

**Figure 11-1 UDC 2300 Exploded View**

**Table 11-1 Parts Identification**

Key Number	Part Number	Description
1	30756667-503	Bezel Assembly (Gray)
2	51309766-501	Display/Keyboard
3	51309782-501	Auxiliary Output/Digital Input PWA
	51309831-501	RS-422/485 Communications PWA
4	51309796-501	Current Output PWA
5	51404896-501	Case Assembly (includes 30755050-001 Mounting Kit)

**Table 11-2 Parts Not Shown**

<b>Part Number</b>	<b>Description</b>
30755223-003	DIN Adaptor (Gray)
30756683-001	NEMA 3 Gasket (Panel to Case)
30755050-001	Mounting Kit
30757215-001	NEMA 4 Adaptor Kit
30756679-501	Open Collector Output printed Wiring Jumper
30756764-002	Rear Terminal Cover Kit
30756018-001	SS Relay 10 Amp (external)
30756725-501	SS Relay 1 Amp (internal)
30754465-501	0-10 Volt Input resistor Assy (100K pair)
30754142-003	Terminal Strip Assy
30755306-501	Electro-mechanical Relay (5 Amp)



## 12 Function Parameter Reference Guide

### 12.1 Overview

#### Purpose of this section

This Reference Guide presents detailed reference data for each function parameter in the UDC 2300 Controller. The reference data is organized in **alphabetical** order by the Function Parameter identification label.

The presented data covers each Function Parameter's:

- Label,
- Name,
- Description,
- Definition of parameter selections or range of setting

#### Reader assumptions

It is assumed that you are familiar with the operation of the UDC 2300 controller, and that you have read the Configuration section - Section 4.

#### In this section

Refer to Table 12-1 for a listing of each function parameter and respective reference subsection.

Table 12-1 Function Parameter Look-up Table

Prompt	Section	Prompt	Section	Prompt	Section	Prompt	Section
0 PCT	12.2.1	DICOM	12.2.29	LSP'S	12.2.57	SGx SP	12.2.85
100 PCT	12.2.2	DIGIN	12.2.30	MANRST	12.2.58	SGx TI	12.2.86
4-20RG	12.2.3	DISPLY	12.2.31	MINRPM	12.2.59	SDMODE	12.2.87
A TUNE	12.2.4	EMISS	12.2.32	OUTALG	12.2.60	SHD_SP	12.2.88
ACTION	12.2.5	ENDSEG	12.2.33	OUT Hi	12.2.61	SHDTIM	12.2.89
ALARM1	12.2.6	EUHRDN	12.2.34	OUT Lo	12.2.62	SOKDEV	12.2.90
ALHYST	12.2.7	EUHRUP	12.2.35	PARITY	12.2.63	SP Hi	12.2.91
AT ERR	12.2.8	FAILSF	12.2.36	PB or GAIN	12.2.64	SP Lo	12.2.92
AUTOMA	12.2.9	FILTR1	12.2.37	PB 2 or GAIN 2	12.2.65	SPPROG	12.2.93
AUXOUT	12.2.10	FILTR2	12.2.38	PBorGN	12.2.66	SPRAMP	12.2.94
AxSxEV	12.2.11	FINLSP	12.2.39	PERIOD	12.2.67	SPRATE	12.2.95
AxSxHL	12.2.12	FREQ	12.2.40	PG END	12.2.68	SP SEL	12.2.96
AxSxTY	12.2.13	FSMODE	12.2.41	PIDSET	12.2.69	SP TRK	12.2.97
AxSxVA	12.2.14	FUZZY	12.2.42	PVSTRT	12.2.70	START	12.2.98
BAUD	12.2.15	HYST	12.2.43	PWROUT	12.2.71	STATE	12.2.99
BIAS 1	12.2.16	I MIN or I RPM	12.2.44	PWR UP	12.2.72	STRSEG	12.2.100
BIAS 2	12.2.17	I2 MIN or I2 RPM	12.2.45	RATE T	12.2.73	SW VAL	12.2.101
BLOCK	12.2.18	INCRMT	12.2.46	RATE2T	12.2.74	TI MIN	12.2.102
BRNOUT	12.2.19	IN1 HI	12.2.47	RATIO1	12.2.75	TIMER	12.2.103
ComADD	12.2.20	IN1 LO	12.2.48	RATIO2	12.2.76	ToBEGN	12.2.104
ComSTA	12.2.21	IN1TYP	12.2.49	RECYCL	12.2.77	TUNE	12.2.105
CSP BI	12.2.22	IN2 HI	12.2.50	RLY TY	12.2.78	TX DLY	12.2.106
CTRALG	12.2.23	IN2 LO	12.2.51	RESET	12.2.79	UNITS	12.2.107
CSRATO	12.2.24	IN2TYP	12.2.52	RN HLD	12.2.80	UNITS	12.2.108
CYC T1 or CT1 X3	12.2.25	L DISP	12.2.53	RPUNIT	12.2.81	XMITR1	12.2.109
CYC2T2 or CT2 X3	12.2.26	LNGUAG	12.2.54	RSPSRC	12.2.82	XMITR2	12.2.110
D BAND	12.2.27	LOCK	12.2.55	SECUR	12.2.83		
DECIMAL	12.2.28	LOOPBACK	12.2.56	SGx RP	12.2.84		

## 12.2 Function Prompts

### Introduction

The reference data is organized in **alphabetical** order by the Function Parameter identification label and referenced by a subsection number.

#### 12.2.1 0 PCT (AUXILIARY OUTPUT LOW SCALING FACTOR)

This prompt is part of the *Options* Set Up Group.

This selection uses a value in engineering units to represent AUXOUT except output which is in percent (%).

**Range of setting:** within the range of the selected variable to represent 4 mA.

#### 12.2.2 100 PCT (AUXILIARY OUTPUT HIGH SCALING FACTOR)

This prompt is part of the *Options* Set Up Group.

This selection uses a value in engineering units to represent AUXOUT except output which is in percent (%).

**Range of setting:** within the range of the selected variable to represent 20 mA.

#### 12.2.3 4-20 RG (CURRENT DUPLEX RANGE)

This prompt is part of the *Algorithm* Set up group.

Used with Output Algorithm selections CURD, CURT, or TCUR.

##### *Selections*

##### *Definitions*

**50 CURRENT DUPLEX RANGE (SPLIT)**—This setting should be used for Relay/Current and Current/Relay Duplex Outputs. It can also be used for Current Duplex when an Auxiliary Output board is present. This enables the normal control current output to provide heat control and the auxiliary current output to provide cool control. To enable this:

- AUX OUT in the Options Set Up group must be selected for Out.
- The Auxiliary Current Output is scaled as desired for 0-50 % controller output.
- Deadband for this configuration only applies to the Current Output. The Auxiliary Output must have the Deadband scaled in.

FOR EXAMPLE: If a 2 % Deadband is desired, then enter **2.0** for the Deadband selection in the Control Algorithm group. This will apply Deadband to the Current Output. In the Options group, set the Auxiliary Output 4mA VAL selection to **49.0** and the 20mA VAL selection to **0.0**.

**100 CURRENT DUPLEX RANGE (FULL)** enables the Current Output to provide both heat and cool functions for control over 0-100 % of the controller output. The PID heat parameters apply when the output is greater than 50 % and the PID cool parameters apply when the output is less than 50 %. The second current output is not required for this type of duplex operation.

**12.2.4 A TUNE** (AUTOTUNE KEY LOCKOUT)

This prompt is part of the *Tuning* Set up group.

This selection allows you to disable the **AUTOTUNE** key. “*LOCK*” must be set to “None”.

*Selections**Definitions*

<b>DIS</b>	Disable the <b>AUTOTUNE</b> key
<b>ENAB</b>	Enables the <b>AUTOTUNE</b> key

---

**12.2.5 ACTION** (CONTROL OUTPUT DIRECTION)

This prompt is part of the *Control* Set up group.

This selection allows you to select the direction you want the controller output to go when the process variable increases.

*Selections**Definitions*

<b>DIR</b>	<b>DIRECT ACTING CONTROL</b> —The controller's output <i>increases</i> as the process variable increases.
<b>REV</b>	<b>REVERSE ACTING CONTROL</b> —The controller's output <i>decreases</i> as the process variable increases.

---

**12.2.6 ALARM1** (LATCHING ALARM FOR OUTPUT)

This prompt is part of the *Alarms* Set up group.

Each alarm output can be configured to be Latching or Non-latching.

**ATTENTION**

When configured for latching, the alarm will stay on, after the alarm condition ends, until the **RUN/HOLD** key is pressed.

---

*Selections**Definitions*

<b>NO L</b>	Non-Latching
<b>LACH</b>	Latching

---

**12.2.7 ALHYST** (ALARM HYSTERESIS)

This prompt is part of the *Alarms* Set up group.

A single adjustable hysteresis is provided on alarms such that when the alarm is OFF it activates at exactly the alarm setpoint; when the alarm is ON, it will not deactivate until the variable is 0.0 % to 100 % away from the alarm setpoint.

Configure the hysteresis of the alarms based on INPUT signals as a % of input range span.

Configure the hysteresis of the alarm based on OUTPUT signals as a % of the full scale output range.

*Range of Setting:* 0.0 to 100.0 % of span or full output as appropriate

**12.2.8 AT ERR** (ACCUTUNE ERROR CODES)

This prompt is part of the *ATUNE* Set up group.

ACCUTUNE ERROR STATUS—When an error is detected in the Accutune process, an error prompt will appear.

*Selections**Definitions*

<b>RUN</b>	<b>RUNNING</b> —An Accutune process is still active checking process gain, even though “TUNE” is not displayed. It does not affect keyboard operation.
<b>NONE</b>	<b>NONE</b> —No errors occurred during last Accutune procedure.
<b>IDFL</b>	<b>IDENTIFICATION PROCESS FAILED</b> —An illegal value for Gain, Rate, or Reset was calculated.
<b>ABRT</b>	<b>CURRENT ACCUTUNE PROCESS ABORTED</b> —Caused by one of the following conditions: <ul style="list-style-type: none"> <li>• changing to manual mode</li> <li>• digital input detected</li> <li>• in heat region of output but a cool output is calculated, or vice versa.</li> </ul>

**12.2.9 AUTOMA** (AUTO/MANUAL KEY LOCKOUT)

This prompt is part of the *Tuning* Set up group.

This selection allows you to disable/enable the **AUTO/MANUAL** key.

*“LOCK” must be set to “None” for the prompt to be displayed.*

*Selections**Definitions*

<b>DIS</b>	Disable the <b>AUTO/MANUAL</b> key
<b>ENAB</b>	Enables the <b>AUTO/MANUAL</b> key

**12.2.10 AUX OUT** (AUXILIARY OUTPUT)

This prompt is part of the *Options* Set Up Group.

This selection provides an MA output representing one of several control parameters. The display for auxiliary output viewing will be in engineering units for all but output. Output will displayed in percent.

**Selections****Definitions**

<b>DIS</b>	No Auxiliary Output
<b>IN 1</b>	This represents the configured range of Input 1 For example: Type J Thermocouple (0 °F to 1600 °F) 0 °F display = 0 % output 1600 °F display = 100 % output
<b>IN 2</b>	This represents the configured range of Input 2
<b>PROC</b>	Process Variable
<b>DEV</b>	Deviation (Process Variable minus Setpoint) – Represents –100 % to + 100 % of the selected PV span in engineering units. For Example: Type T Thermocouple PV range = -300 °F to +700 °F PV span = 1000 °F Deviation Range = –1000 °F to +1000 °F If PV = 500 °F and SP = 650 °F then Deviation Display = –150 °F Auxiliary Output = 42.5 %  When Deviation is selected, only one operating parameter will be entered. This value represents the deviation level that will produce 20 mA (100 %) output Zero deviation will produce a center scale (12 mA or 50 %) output. A negative deviation equal in magnitude to the auxiliary output high value will produce a low end (4 mA or 0 %) output.
<b>OUTPUT</b>	OUTPUT – represents the displayed controller output in percent (%). Cannot be used with 3 Position Step Control.
<b>SP</b>	SETPOINT – represents the value of the setpoint in units of PV.
<b>LSP1</b>	Local Setpoint One – Auxiliary output represents local setpoint one regardless of active setpoint.

---

**12.2.11 AxSxEV** (ALARM<sub>x</sub> SETPOINT<sub>x</sub> EVENT - X = 1 OR 2)

This prompt is part of the *Alarms* Set up group.

Select whether you want the alarm type chosen in prompt AxSxTY to alarm the beginning or end of a segment in setpoint Ramp/Soak programming.

**ATTENTION**

Select if Setpoint Programming is *enabled* and if the Alarm Type is configured for Event On/Off. Alarms configured for events will not operate on Setpoint Program segments of zero length.

---

<i>Selections</i>	<i>Definitions</i>
<b>BEGN</b>	Beginning of Segment
<b>END</b>	End of Segment

---

**12.2.12 AxSxHL** (ALARM<sub>x</sub> SETPOINT<sub>x</sub> STATE - X = 1 OR 2)

This prompt is part of the *Alarms* Set up group.

Select whether you want the alarm type chosen in prompt AxSxTY to alarm High or Low

.

**ATTENTION**

Select if Setpoint Programming is *disabled* or if the Alarm Type is not configured for Event On/Off.

---

<i>Selections</i>	<i>Definitions</i>
<b>HIGH</b>	High Alarm
<b>LOW</b>	Low Alarm

---

**12.2.13 AxSxTY** (ALARM<sub>x</sub> SETPOINT<sub>x</sub> TYPE - X = 1 OR 2)

This prompt is part of the *Alarms* Set up group.

Select what you want Setpoint x of Alarm x to represent. It can represent the Process Variable, Deviation, Input 1, Input 2, Output, Remote Setpoint, PV rate of Change, Loop Break, or Failsafe, and if you have a model with communications, you can configure the controller to alarm on SHED. If you have setpoint programming, you can alarm when a segment goes ON or OFF.

**Selections****Definitions**

<b>NONE</b>	Disables the alarms.
<b>IN 1</b>	Input 1
<b>IN 2</b>	Input 2
<b>PV</b>	Process Variable
<b>DE</b>	Deviation
<b>OUT</b>	Output (note 1)
<b>SHED</b>	Shed from Communications
<b>EVON</b>	Event ON (Setpoint Programmer)
<b>EVOF</b>	Event OFF (Setpoint Programmer)
<b>MAN</b>	Alarm on Manual mode (note 2)
<b>RSP</b>	Remote Setpoint
<b>FSAF</b>	Failsafe
<b>PVRT</b>	PV Rate of Change
<b>DI</b>	Alarm on Digital Input
<b>DE II</b>	Deviation Alarm based on deviation from 2 <sup>nd</sup> Local Setpoint or Remote SP regardless of which SP is active.
<b>BRAK</b>	Loop Break (note 3)

---

**NOTE 1** *When the controller is configured for Three Position Step Control, alarms set for Output will not function.*

**NOTE 2** *Not available if Timer is enabled because Alarm 1 is dedicated to Timer output.*

**NOTE 3** *When enabled, the control output is checked for minimum and maximum limits. When this occurs, a timer begins and, if the output has not caused the PV to be corrected by a pre-determined amount and time, the alarm activates. For loop break alarms, the timer value may be changed only for controllers configured for On-Off control.*

---



**12.2.14 AxSxVA** (ALARM<sub>x</sub> SETPOINT<sub>x</sub> VALUE - X = 1 OR 2)

This prompt is part of the *Alarms* Set up group.

This is the value at which you want the alarm type chosen in Prompt “AxSxTY” to actuate. The value depends on what the alarm setpoint has been configured to represent.

For **SP Programming**, the value is the segment number for which the event applies.

For **PV Rate of Change**, the value is the amount of PV rate of change in one minute in engineering units.

This prompt does not appear for “Alarm on Manual” type alarm (i.e., AxSxTY is set to MAN).

*Range of Setting:* within the range of the selected parameter or of the PV Span for Deviation configurations.

**12.2.15 BAUD** (BAUD RATE)

This prompt is part of the *Communications* Set up group.

**BAUD RATE** is the transmission speed in bits per second.

<i>Selections</i>	<i>Definitions</i>
<b>2400</b>	2400 BAUD
<b>4800</b>	4800 BAUD
<b>9600</b>	9600 BAUD
<b>19200</b>	19200 BAUD

**12.2.16 BIAS 1** (INPUT 1 BIAS)

This prompt is part of the *Input 1* Set up group.

Bias is used to compensate the input for drift of an input value due to deterioration of a sensor, or some other cause. Select the bias value you want on Input 1.

*Range of Setting:* -999 to 9999

**12.2.17 BIAS 2** (INPUT 2 BIAS)

This prompt is part of the *Input2* Set up group.

Bias is used to compensate the input for drift of an input value due to deterioration of a sensor, or some other cause. Select the bias value you want on Input 2.

*Range of Setting:* -999 to 9999

### 12.2.18 **BLOCK** (ALARM BLOCKING)

This prompt is part of the *Alarms Set up* group.

Prevent nuisance alarms when the controller is first powered up. The alarm is suppressed until the parameter gets to the non-alarm limit or band. Alarm blocking affects both alarm setpoints.

**ATTENTION**

When enabled on power up or initial enabling via configuration, the alarm will not activate unless it has not been in alarm for one cycle (167 ms).

---

<i>Selections</i>	<i>Definitions</i>
<b>DIS</b>	Disable Blocking
<b>BK1</b>	Blocks Alarm 1 only
<b>BK2</b>	Blocks Alarm 2 only
<b>BK12</b>	Blocks Alarm 1 and Alarm 2

---

### 12.2.19 **BRNOUT** (BURNOUT PROTECTION - SENSOR BREAK)

This prompt is part of the *Input 1 Set up* group.

BURNOUT PROTECTION (SENSOR BREAK) provides most input types with upscale or downscale protection if the input fails. 1-5V, 0-10V, or 4-20 mA inputs require no burnout or NONE selection.

<i>Selections</i>	<i>Definitions</i>
<b>NONE</b>	<b>NO BURNOUT</b> —Pre-configured Failsafe output applied if failed input is detected (does not apply for an input out of range). Error message IN 1 FAIL is flashed on the lower display intermittently every 10 seconds.
<b>UP</b>	<b>UPSCALE BURNOUT</b> —will make the PV signal increase to full scale, +10 %, when a sensor fails, and flash IN 1 FAIL on the lower display intermittently every 10 seconds. The controller remains in Automatic control mode and adjusts the controller output signal in response to the full scale PV signal developed by the Burnout circuitry.
<b>DOWN</b>	<b>DOWNSCALE BURNOUT</b> —will make the PV signal decrease to the lower range value, -10 %, when a sensor fails, and flash INPUT 1 FAIL on the lower display intermittently every 10 seconds. The controller remains in Automatic control mode and adjusts the controller output signal in response to the zero percent PV signal developed by the Burnout circuitry.
<b>NOFS</b>	<b>NO FAILSAFE</b> —This selection does not provide input failure detection and should only be used when an absolute accuracy is the most important criteria. (For this selection, no burnout signal went to the sensor.)

---

---

**12.2.20 ComADD** (STATION ADDRESS)

This prompt is part of the *Communications* Set up group.

This is a number that is assigned to a controller that is to be used with the communications option. This number will be its address.

*Range of Setting: 1 to 99*

---

**12.2.21 ComSTA** (COMMUNICATIONS STATE)

This prompt is part of the *Communications* Set up group.

This prompt lets you select the type of communications protocol.

*Selections**Definitions*

**DIS** Disable

**R422** RS-422/485 ASCII - Allows RS422/485 ASCII communication prompts.

**MODB** MODBUS - Allows Modbus RTU communication prompts

---

**12.2.22 CSP BI** (COMPUTER SETPOINT BIAS)

This prompt is part of the *Communications* Set up group.

Computer setpoint bias

*Range of Setting: -999 to 9999 in Engineering Units*

---

**12.2.23 CTRLG** (CONTROL ALGORITHM)

This prompt is part of the *Algorithm* Set up group.

This prompt lets you select the type of control that is best for your process.

*Selections**Definitions*

**ONOF** **ON/OFF** is the simplest control type. The output can be either ON (100 %) or OFF (0 %). The Process Variable (PV) is compared with the setpoint (SP) to determine the sign of the error ( $ERROR = PV - SP$ ). The ON/OFF algorithm operates on the sign of the error signal.

In Direct Acting Control, when the error signal is positive, the output is 100 %; and when the error signal is negative, the output is 0 %. If the control action is reverse, the opposite is true. An adjustable overlap (Hysteresis Band) is provided between the on and off states.

Other prompts affected: "HYST"

**DUPLEX ON/OFF** is an extension of this algorithm when the output is configured for Duplex. It allows the operation of a second ON/OFF output. There is a deadband between the operating ranges of the two inputs and an

---

adjustable overlap (hysteresis) of the on and off states of each output. Both Deadband and Hysteresis are separately adjustable. With no relay action the controller will read 50 %.

Other prompts affected: “HYST” and “D BAND”

**PIDA**

PID A is normally used for three-mode control. This means that the output can be adjusted somewhere between 100 % and 0 %. It applies all three control actions—Proportional (P), Integral (I), and Derivative (D)—to the error signal.

*Proportional (Gain)*—Regulates the controller’s output in proportion to the error signal (the difference between Process Variable and Setpoint).

*Integral (Reset)*—Regulates the controller's output to the size of the error and the time the error has existed. (The amount of corrective action depends on the value of proportional Gain.)

*Derivative (Rate)*—Regulates the controller's output in proportion to the rate of change of the error. (The amount of corrective action depends on the value of proportional Gain.)

**NOTE:** *PID A should not be used for Proportional only action (that is, no integral (reset) action). Instead, use PD+MR with rate set to 0.*

**PIDB**

Unlike the PID A equation, the controller gives only an integral response to a setpoint change, with no effect on the output due to the gain or rate action, and it gives full response to PV changes. Otherwise controller action is as described for the PID A equation. See note on PID A

**PDMR**

**PD WITH MANUAL RESET** is used whenever integral action is not wanted for automatic control. The equation is computed with no integral contribution. The MANUAL RESET, which is operator adjustable, is then added to the present output to form the controller output. Switching between manual and automatic mode will not be bumpless.

If you select PD with Manual Reset you can also configure the following variations

- PD (Two Mode) control,
- P (Single Mode) control.

Set Rate (D) to 0.

Other prompts affected: “MANRST” in the *TUNING* Set Up Group.

**TPSC**

The **THREE POSITION STEP** algorithm allows the control of a valve (or other actuator), with an electric motor driven by two controller relay outputs; one to move the motor upscale, the other downscale without a feedback slidewire linked to the motor shaft. The deadband and hysteresis are adjustable in the same manner as the relay duplex output algorithm.

The Three Position Step Control algorithm provides an output display (OUT) which is an estimated motor position since the motor is not using any feedback. Although this output indication is only an approximation, it is

“corrected” each time the controller drives the motor to one of its stops (0 % or 100 %). It avoids all the control problems associated with the feedback slidewire (wear, dirt, noise). When operating in this algorithm, the estimated “OUT” display is shown to the nearest percent (that is, no decimal).

Other prompts affected: D BAND

---

### 12.2.24 **CSRATO** (COMPUTER SETPOINT RATIO)

This prompt is part of the *Communications* Set up group.

**RATIO**—Computer setpoint ratio

*Range of Setting: -20.0 to 20.0*

---

### 12.2.25 **CYC T1 or CT1 X3** (CYCLE TIME - HEAT)

This prompt is part of the *Tuning* Set up group.

CYCLE TIME (HEAT) determines the length of one time proportional output relay cycle. Defined as “HEAT” Cycle time for Heat/Cool applications.

CYC TI—Electromechanical relays (seconds)

CTIX3—Solid state relays (1/3 seconds)

Cycle times are in either second or 1/3-second increments depending upon the configuration of RLY TY in the Output Algorithm Set Up group.

*Range of Setting: 1 to 120*

---

#### ATTENTION

If 1/3 second increments are used, 1 = .33 seconds and 120 = 40 seconds.

---

**12.2.26 CYC2T2 or CT2 X3** (CYCLE TIME2 - COOL)

This prompt is part of the *Tuning* Set up group.

**CYCLE TIME2 (COOL)** determines the length of one time proportional output relay cycle. Defined as “COOL” Cycle time for Heat/Cool applications.

**CYC2TI**—Electromechanical relays (seconds)

**CT2X3**—Solid state relays (1/3 seconds)

Cycle times are in either second or 1/3-second increments depending upon the configuration of RLY TY in the Output Algorithm Set Up group.

*Range of Setting: 1 to 120*

---

**ATTENTION**

If 1/3 second increments are used, 1 = .33 seconds and 120 = 40 seconds.

---

**12.2.27 DBAND** (DEADBAND)

This prompt is part of the *Control* Set up group.

DEADBAND is an adjustable gap between the operating ranges of output 1 and output 2 in which neither output operates (positive value) or both outputs operate (negative value). It is the difference between the nominal trip points of relays 1 and 2.

Shows when only Time Duplex or Three Position Step is selected.

*Range of Setting: -5.0 to 25.0 % (Time Duplex)  
0.5 to 5.0 % (Three Position Step)*

**12.2.28 DECIMAL** (DECIMAL POINT LOCATION)

This prompt is part of the *Input 1* Set up group.

This selection determines where the decimal point appears in the display.

**Selections****Definitions**

<b>8888</b>	None
<b>888.8</b>	One Place
<b>88.88</b>	Two Places (range is only $\pm 99.99$ )

---

### 12.2.29 DI COM (DIGITAL INPUT COMBINATIONS)

This prompt is part of the *Options Set Up Group*

There are five selections available for combination with any digital input selection.

<i>Selections</i>	<i>Definitions</i>
<b>DIS</b>	DISABLE-Disables combination function.
<b>+PD2</b>	Any Digital Input Selection PLUS PID2-Contact closure selects PID Set 2.
<b>+DIR</b>	Any Digital Input Selection PLUS DIRECT ACTION – Contact closure selects direct controller action.
<b>+SP2</b>	Any Digital Input Selection PLUS SETPOINT 2 – Contact closure puts the controller into setpoint 2.
<b>+SP1</b>	Any Digital Input Selection PLUS SETPOINT 1 – Contact closure puts the controller into setpoint 1.
<b>+RUN</b>	Any Digital Input Selection PLUS RUN SETPOINT PROGRAM/RAMP – Contact closure starts SP Program/Ramp if enabled.

### 12.2.30 DIG IN (DIGITAL INPUT)

This prompt is part of the *Options Set Up Group*

This selection allows remote selection of various parameters.

<i>Selections</i>	<i>Definitions</i>
<b>NONE</b>	NO DIGITAL INPUT SELECTIONS
<b>MAN</b>	TO MANUAL – Contact closure puts the affected loop into manual mode. Contact open returns controller to former mode.
<b>LSP</b>	TO LOCAL SETPOINT – When a remote setpoint is configured, contact closure puts the controller into local setpoint 1. When contact opens, the controller returns to former operation – local or remote setpoint – unless <b>SETPOINT SELECT</b> key is pressed while digital input is active. If this happens, the controller will stay in the local setpoint mode when contact opens.
<b>SP2</b>	TO LOCAL SETPOINT TWO - Contact closure puts the controller into local setpoint 2.
<b>DIR</b>	TO DIRECT ACTION - Contact closure selects direct controller action.
<b>HOLD</b>	TO HOLD – Contact closure suspends Setpoint Program or Setpoint Ramp. When contact reopens, the controller starts from the Hold point of the Ramp/Program unless the Ramp/Program was not previously started via the <b>RUN/HOLD</b> key.  This selection applies to either loop.
<b>PID2</b>	TO PID2 – Contact closure selects PID Set 2.

- RUN** RUN – Contact closure starts a stopped SP Ramp or Program. Upper left characters blinks "R". Reopening the contact puts controller in HOLD mode.
- BEGN** EXTERNAL SP PROGRAM RESET – Contact closure resets SP Program back to the beginning of the first segment in the program and places the program in HOLD mode. Program cycle number is not affected. Reopening switch has not effect.
- ATTENTION** Once the last segment of the setpoint program has timed out, the controller enters the mode of action specified in the configuration data and the program cannot be reset to the beginning of the first segment by digital input closure.
- NO\_I** INHIBIT INTEGRAL (RESET) – Contact closure disables PID Integral (Reset) action.
- MANFS** MANUAL FAILSAFE OUTPUT – Controller goes to Manual mode, output goes to the Failsafe value.
- ATTENTION** This will cause a bump in the output when switching from Automatic to Manual. The switch back from Manual to Automatic is bumpless. When the switch is closed, the output can be adjusted from the keyboard after pressing the **MANUAL/AUTO** key to the put the controller in the Manual mode.
- LOCK** KEYBOARD LOCKOUT – Contact closure disables all keys. Lower display shows LOCKED if a key is pressed.
- TIMR** TIMER – Contact closure starts timer, if enabled. Reopening the switch has no effect.
- TUNE** INITIATE LIMIT CYCLE TUNING – Contact closure starts the tuning process. The lower display shows TUNE ON. Opening the contact has no effect.
- INIT** SETPOINT INITIALIZATION – Contact closure forces the setpoint to the current PV value. Opening the contact has no effect.
- RSP** TO REMOTE SETPOINT – Contact closure selects the Remote setpoint.
- MNLT** MANUAL LATCHING – Contact closure transition forces the loop to Manual mode. Opening the switch has no effect. If the **MANUAL/AUTO** key is pressed while the switch is closed, the loop will return to Automatic mode.
- TRAK** OUTPUT TRACKING – Contact closure allows output to track Input 2. For the Output Tracking, when the switch is open, the output is in accordance with its predefined functionality. When the switch is closed, the output value (in percent) will track the Input 2 percent of range value. When the switch is reopened, the output will start at this last output value and normal PID action will then take over control. The transfer is bumpless.
- NOTE: Output Tracking does not apply to Three Position Step Control.



**12.2.31 DISPLAY** (SINGLE DISPLAY DEFAULT)

This prompt is part of the *Input 1* Set Up Group on single display models.

Pressing the **DISPLAY** key will cycle through all applicable values. One minute after the last press of the display key, the display will revert to the display configured here.

*Selections**Definitions*

<b>SP</b>	Active Setpoint
<b>PRY</b>	Process Variable with lower display prompt.
<b>PRn</b>	Process Variable with <i>no</i> lower display prompt.

**12.2.32 EMISS** (EMISSIVITY)

This prompt is part of the *Input 1* Set up group.

**EMISSIVITY** is a correction factor applied to the Radiamatic input signal that is the ratio of the actual energy emitted from the target to the energy which would be emitted if the target were a perfect radiator. Available only for “Radiamatic” inputs.

*Range of Setting: 0.01 to 1.00*

**12.2.33 ENDSEG** (END SEGMENT)

This prompt is part of the *Setpoint Ramp/Program* Set up group.

The end segment number designates the number of the last segment, it must be a soak segment (even number).

*Range of Setting: 2 to 12*

**12.2.34 EUHRDN** (RATE DOWN VALUE)

This prompt is part of the *Setpoint Rate* Set up group.

When making a setpoint change, this is the rate at which the controller will change from the original setpoint down to the new one. The ramping (current) setpoint can be viewed as SPn in the lower display.

Entering a 0 will imply an immediate change in Setpoint (i.e., no rate applies).

*Range of Setting: 0 to 9999 in Engineering Units per Hour*

**12.2.35 EUHRUP** (RATE UP VALUE)

This prompt is part of the *Setpoint Rate* Set up group.

When making a setpoint change, this is the rate at which the controller will change from the original setpoint up to the new one. The ramping (current) setpoint can be viewed as SPn in the lower display.

Entering a 0 will imply an immediate change in Setpoint (i.e., no rate applies).

*Range of Setting: 0 to 9999 in Engineering Units per Hour*

**12.2.36 FAILSF** (FAILSAFE OUTPUT VALUE)

This prompt is part of the *Control Set up* group.

The value used here will also be the output level when Input 1 fails for all inputs except T/C, or when NO BURNOUT is configured and input 1 fails for T/C Inputs.

**Range of Setting:** 0 to 100 %

**For 3 Position Step**

100 - Motor position set to 100 % output position (open)

0 - Motor position set to 0 % output position (closed)

---

**12.2.37 FILTR1** (INPUT 1 FILTER)

This prompt is part of the *Input 1 Set up* group.

A software digital filter is provided for input 1 to smooth the input signal. You can configure the first order lag time constant from 1 second to 120 seconds. If you do not want filtering, enter 0.

**Range of Setting:** 1 to 120

0 = No Filter

---

**12.2.38 FILTR2** (INPUT 2 FILTER)

This prompt is part of the *Input 2 Set up* group.

A software digital filter is provided for input 2 to smooth the input signal. You can configure the first order lag time constant from 1 second to 120 seconds. If you do not want filtering, enter 0.

**Range of Setting:** 1 to 120

0 = No Filter

---

**12.2.39 FINLSP** (SINGLE SETPOINT RAMP FINAL SETPOINT)

This prompt is part of the *Setpoint Ramp/Program Set up* group.

Enter the value desired for the final setpoint. The controller will operate at the setpoint set here when ramp is ended.

**ATTENTION**

If the ramp is on HOLD, the held setpoint can be changed by the increment or decrement keys. However, the ramp time remaining and original ramp rate is not changed. Therefore, when returning to RUN mode, the setpoint will ramp at the same rate as previous to the local setpoint change and will stop if the final setpoint is reached before the time expires. If the time expires before the final setpoint is reached, it will jump to the final setpoint.

---

**Range of Setting:** within the setpoint limits

---

**12.2.40    FREQ**       (POWER LINE FREQUENCY)

This prompt is part of the *Input 1* Set up group.

At what power line frequency are you going to operate?

<i>Selections</i>	<i>Definitions</i>
<b>60</b>	60 Hertz
<b>50</b>	50 Hertz

**12.2.41    FSMODE** ( FAILSAFE MODE)

This prompt is part of the *Control* Set Up group.

This selection determines what state the controller will revert to if it goes into Failsafe.

<i>Selections</i>	<i>Definitions</i>
<b>NO L</b>	Controller stays in last mode (automatic or manual); output goes to Failsafe value.
<b>LACH</b>	Controller goes to manual mode; output goes to Failsafe value.

**12.2.42    FUZZY**       (FUZZY OVERSHOOT SUPPRESSION)

This prompt is part of the *Accutune* Set up group.

The UDC will use Fuzzy Logic to inherently suppress or minimize any overshoot that may occur, when PV approaches SP, as a result of the existing tuning parameters. It does NOT change the parameters.

Can be enabled or disabled independently of whether Demand Tuning is enabled or disabled.

<i>Selections</i>	<i>Definitions</i>
<b>DIS</b>	Disable the Fuzzy Overshoot Suppression.
<b>ENAB</b>	Enables the Fuzzy Overshoot Suppression.

**12.2.43    HYST**       (HYSTERESIS - OUTPUT RELAY ONLY)

This prompt is part of the *Control* Set up group.

HYSTERESIS is an adjustable overlap of the ON/OFF states of each control output. This is the difference between the value of the process variable at which the control outputs energize and the value at which they de-energize. Only applicable for ON-OFF control.

**Range of Setting:**    0.0 to 100.0 % of PV (*On/Off Control*)

**12.2.44 I MIN or I RPM** (RESET - INTEGRAL TIME)

This prompt is part of the *Tuning* Set up group.

**I MIN** = RESET TIME IN MINUTES / REPEAT

**I RPM** = RESET TIME IN REPEATS PER MINUTE

**RESET RATE or INTEGRAL TIME** adjusts the controller's output in accordance with both the size of the deviation (SP-PV) and the time it lasts. The amount of the corrective action depends on the value of Gain. The Reset adjustment is measured as how many times proportional action is repeated/minute.

*Used with control algorithm PID-A.*

*Defined as "HEAT" Reset on Duplex models for variations of Heat/Cool applications. The selection of minutes per repeat or repeats per minute is made in the Control parameters group under prompt "MINRPM."*

**Range of Setting:** 0.02 to 50.00

---

**12.2.45 I2 MIN or I2 RPM** (RESET2 - INTEGRAL TIME)

This prompt is part of the *Tuning* Set up group.

**I2 MIN** = RESET IN MINUTES / REPEAT

**I2 RPM** = RESET IN REPEATS PER MINUTE

**RESET RATE 2 or INTEGRAL TIME 2** adjusts the controller's output in accordance with both the size of the deviation (SP-PV) and the time it lasts. The amount of the corrective action depends on the value of Gain. The Reset adjustment is measured as how many times proportional action is repeated/minute.

*Used with control algorithm PID-A.*

*Defined as "COOL" Reset on Duplex models for variations of Heat/Cool applications or for a Second Set of PID constants.*

*The selection of minutes per repeat or repeats per minute is made in the Control parameters group under prompt "MINRPM."*

**Range of Setting:** 0.02 to 50.00

---

**12.2.46 INCRMT** (TIME COUNT INCREMENT)

This prompt is part of the *Timer* Set Up group.

This selection determines how the timer's count will increment.

**Selections****Definitions**

**MIN** Counts in hours:minutes.

**SEC** Counts in minutes:seconds.

---

**12.2.47 IN1 HI** (INPUT 1 HIGH RANGE VALUE)

This prompt is part of the *Input 1* Set up group.

This selection lets you the Input 1 high range value in engineering units.

**Linear or Square Root Inputs only.**

Scale the #1 input signal to the display value you want for 100 %.

EXAMPLE:

Actuation (Input) = 4 to 20 mA  
Process Variable = Flow  
Range of Flow = 0 to 250 Gal/Min  
High Range display value = 250  
Then 20 mA = 250 Gal/Min

The control setpoint will be limited by the range of units selected here.

**Range of Setting:** -999 to 9999 (*floating*) in Engineering Units

---

**12.2.48 IN1 LO** (INPUT 1 LOW RANGE VALUE)

This prompt is part of the *Input 1* Set up group.

This selection lets you the Input 1 Low range value in engineering units.

**Linear or Square Root Inputs only.**

Scale the #1 input signal to the display value you want for 0 %.

EXAMPLE:

Actuation (Input) = 4 to 20 mA  
Process Variable = Flow  
Range of Flow = 0 to 250 Gal/Min  
Low Range display value = 0  
Then 4 mA = 0 Gal/Min

The control setpoint will be limited by the range of units selected here.

**Range of Setting:** -999 to 9999 (*floating*) in Engineering Units

---

**12.2.49 IN1TYP** (INPUT 1 ACTUATION TYPE)

This prompt is part of the *Input 1* Set up group.

This selection determines what actuation you are going to use for Input 1.

**ATTENTION**

Changing the input type will result in the loss of Field Calibration values and will restore Factory Calibration values.

*Selections**Definitions*

<b>B</b>	<b>B</b> —B Thermocouple
<b>E H</b>	<b>E H</b> —E Thermocouple High
<b>E L</b>	<b>E L</b> —E Thermocouple Low
<b>J H</b>	<b>J H</b> —J Thermocouple High
<b>J L</b>	<b>J H</b> —J Thermocouple Low
<b>K H</b>	<b>K H</b> —K Thermocouple High
<b>K L</b>	<b>K H</b> —K Thermocouple Low
<b>NNMH</b>	<b>NNMH</b> —Ni-Ni-Moly Thermocouple High
<b>NNML</b>	<b>NNML</b> —Ni-Ni-Moly Thermocouple Low
<b>N90H</b>	<b>N90H</b> —NiMo-NiCo Thermocouple High
<b>N90L</b>	<b>N90L</b> —NiMo-NiCo Thermocouple Low
<b>NIC</b>	<b>NIC</b> —Nicrosil-Nisil Thermocouple
<b>R</b>	<b>R</b> —R Thermocouple
<b>S</b>	<b>S</b> —S Thermocouple
<b>T H</b>	<b>T H</b> —T Thermocouple High
<b>T L</b>	<b>T L</b> —T Thermocouple Low
<b>W H</b>	<b>W H</b> —W5W26 Thermocouple High
<b>W L</b>	<b>W L</b> —W5W26 Thermocouple Low
<b>100H</b>	<b>100H</b> —100 Ohm RTD High
<b>100L</b>	<b>100L</b> —100 Ohm RTD Low
<b>200</b>	<b>200</b> —200 Ohm RTD
<b>500</b>	<b>500</b> —500 Ohm RTD
<b>RADH</b>	<b>RADH</b> —Radamatic RH
<b>RADI</b>	<b>RADI</b> —Radamatic RI
<b>0-20</b>	<b>0-20</b> —0 to 20 Milliamperes
<b>4-20</b>	<b>4-20</b> —4 to 20 Milliamperes
<b>10m</b>	<b>10m</b> —0 to 10 Millivolts
<b>50m</b>	<b>50m</b> —0 to 50 Millivolts
<b>0-5</b>	<b>0-5</b> —0 to 5 Volts
<b>1-5</b>	<b>1-5</b> —1 to 5 Volts
<b>0-10</b>	<b>0-10</b> —0 to 10 Volts
<b>100m</b>	<b>100m</b> —0 to 100 Millivolts

**12.2.50 IN2 HI** (INPUT 2 HIGH RANGE VALUE)

This prompt is part of the *Input2* Set up group.

This selection lets you the Input2 high range value in engineering units.

**Linear or Square Root Inputs only.**

Scale the #2 input signal to the display value you want for 100 %.

EXAMPLE:

Actuation (Input) = 4 to 20 mA  
Process Variable = Flow  
Range of Flow = 0 to 250 Gal/Min  
High Range display value = 250  
Then 20 mA = 250 Gal/Min

The control setpoint will be limited by the range of units selected here.

**Range of Setting:** -999 to 9999 (*floating*) in *Engineering Units*

---

**12.2.51 IN2 LO** (INPUT 2 LOW RANGE VALUE)

This prompt is part of the *Input2* Set up group.

This selection lets you the Input 2 Low range value in engineering units.

**Linear or Square Root Inputs only.**

Scale the #2 input signal to the display value you want for 0 %.

EXAMPLE:

Actuation (Input) = 4 to 20 mA  
Process Variable = Flow  
Range of Flow = 0 to 250 Gal/Min  
Low Range display value = 0  
Then 4 mA = 0 Gal/Min

The control setpoint will be limited by the range of units selected here.

**Range of Setting:** -999 to 9999 (*floating*) in *Engineering Units*

---

**12.2.52 IN2TYP** (INPUT 2 ACTUATION TYPE)

This prompt is part of the *Input2* Set up group.

This selection determines what actuation you are going to use for Input 2.

<i>Selections</i>	<i>Definitions</i>
<b>DIS</b>	<b>DIS</b> —Disable Input 2
<b>0-20</b>	<b>0-20</b> —0 to 20 Milliamperes
<b>4-20</b>	<b>4-20</b> —4 to 20 Milliamperes
<b>0-5</b>	<b>0-5</b> —0 to 5 Volts
<b>1-5</b>	<b>1-5</b> —1 to 5 Volts
<b>0-2</b>	<b>0-2</b> —0 to 2 Volts

---

**12.2.53 L DISP** (DISPLAY FOR TIMER OPTION)

This prompt is part of the *Timer* Set up group.

This selection allows you to select what is displayed for the timer option. The time is shown on the lower display in hh:mm or mm:ss format along with a rotating “clock” character.

<i>Selections</i>	<i>Definitions</i>
<b>TREM</b>	If the “clock” rotation is counterclockwise, <b>time remaining</b> is indicated.
<b>ET</b>	If the “clock” rotation is clockwise, <b>elapsed time</b> is indicated.

---

**12.2.54 LNGUAG** (LANGUAGE)

This prompt is part of the *Input 1* Set up group.

Select what the language will be for the displays.

<i>Selections</i>	<i>Definitions</i>
<b>ENGL</b>	English
<b>FREN</b>	French
<b>GERM</b>	German
<b>SPAN</b>	Spanish
<b>ITAL</b>	Italian
<b>NUMB</b>	Numeric

---



**12.2.55 LOCK** (LOCKOUT)

This prompt is part of the *Tuning* Set up group.

LOCKOUT applies to one of the functional groups: Configuration, Calibration, Tuning, Accutune.

**DO NOT CONFIGURE UNTIL ALL CONFIGURATION IS COMPLETE.**

<i>.Selections</i>	<i>Definitions</i>
<b>NONE</b>	No lockout; all groups are read/write
<b>CAL</b>	All groups are available for read/write except for the Calibration and Keyboard Lockout groups.
<b>CONF</b>	Timer, Tuning, SP Ramp, and Accutune groups are read/write. All other groups are read only. Calibration and Keyboard Lockout groups are not available.
<b>VIEW</b>	Tuning and Setpoint Ramp parameters are read/write. No other parameters can be viewed.
<b>ALL</b>	Tuning and Setpoint Ramp parameters are available for read only. No other parameters can be viewed.

**12.2.56 LOOPBACK** (LOCAL LOOPBACK TEST)

This prompt is part of the *Communications* Set up group.

<i>Selections</i>	<i>Definitions</i>
<b>DIS</b>	Disables the Loopback test
<b>ENAB</b>	Allows loopback test. The UDC goes into Loopback mode in which it sends and receives its own message. The UDC displays PASS or FAIL status in the upper display and LOOPBACK in the lower display while the test is running. The UDC will go into manual mode. The test will run until the operator disables it here, or until power is turned off and on.

**ATTENTION** The UDC does not have to be connected to the RS-485 link to perform this test. If it is connected, only one UDC 2300 should run the loopback test at a time. The computer should not be transmitting on the link while the loopback test is active.

**12.2.57 LSP'S** (LOCAL SETPOINT SOURCE)

This prompt is part of the *Control* Set up group.

This selection determines what your local setpoint source will be.

<i>Selections</i>	<i>Definitions</i>
<b>ONE</b>	<b>LOCAL SETPOINT 1</b> —The setpoint entered from the keyboard.
<b>TWO</b>	<b>TWO LOCAL SETPOINTS</b> —This selection lets you switch between two local setpoints using the <b>FUNCTION</b> key.

**12.2.58 MANRST** (MANUAL RESET)

This prompt is part of the *Tuning* Set up group.

**MANUAL RESET** is only applicable if you have control algorithm PD WITH MANUAL RESET (**PD + MR**). Because a proportional controller will not necessarily line out at setpoint, there will be a deviation (offset) from setpoint. This eliminates the offset and lets the PV line out at setpoint.

**NOTE:** This Manual Reset value is also available as a lower display parameter, BI.

*Range of Setting: -100 to +100 (in % of output)*

---

**12.2.59 MINRPM** (RESET UNITS)

This prompt is part of the *Control* Set up group.

Selects units of minutes or repeat per minutes for the I term of the PID algorithm.  
20 Repeats per Minute = 0.05 Minutes per Repeat.

*Selections**Definitions*

- |            |   |
|------------|---|
| <b>RPM</b> | <b>REPEATS PER MINUTE</b> — The number of times per minute that proportional action is repeated by reset. |
| <b>MIN</b> | <b>MINUTES PER REPEAT</b> — The time between each repeat of the proportional action by reset.             |
- 

**12.2.60 OUTALG** (OUTPUT ALGORITHM)

This prompt is part of the *Algorithm* Set up group.

The **OUTPUT ALGORITHM** lets you select the type of output you want.

Not applicable with Control Algorithm prompt “TPSC.”

*Selections are model dependent. For example, current output models cannot be configured for Time Proportioning Simplex Output.*

*Selections**Definitions*

- |             |  |
|-------------|--|
| <b>RLY</b>  | <b>TIME SIMPLEX</b> — Type of output using one SPDT relay. Its normally open (NO) or normally closed (NC) contacts are wired at the rear terminals.<br><br>Other prompts affected: “HYST”  |
| <b>CUR</b>  | <b>CURRENT SIMPLEX</b> — Type of output using one 4 to 20 mA signal that can be fed into a positive or negative grounded load of 0 to 750 ohms. The signal can be recalibrated for any desired range from 4 mA to 20 mA for 0 % to 100 % output. |
| <b>RLYD</b> | <b>TIME DUPLEX</b> — Type of output using two SPST relays. Its normally open (NO) or normally closed (NC) contacts are wired at the rear terminals.<br><br>Other prompts affected: “D BAND” and “HYST”   |
-

- 
- CURD**     **CURRENT DUPLEX** — is similar to current simplex but uses a second current output. The second output is usually scaled so that zero and span correspond with 0 % and 50 % output (cool zone). When the output is 0 % to 50 %, the controller uses tuning parameter set #2, when the output is 50 % to 100 % it uses set #1.  
Other prompts affected: 4-20RG
- CURT**     **CURRENT/TIME DUPLEX** — is a variation of duplex with current active for 0 % to 50 % output (tuning set 2) and time is active 50 % to 100 % output (tuning set 1). Relay controls heat, current controls cool.  
Other prompts affected: 4-20RG
- TCUR**     **TIME CURRENT DUPLEX** — is similar to CUR TI except that current is active for 50 % to 100 % and time is active for 0 % to 50 %. Relay controls cool, current controls heat.  
Other prompts affected: 4-20RG
- 

### 12.2.61     **OUT Hi**     (HIGH OUTPUT LIMIT)

This prompt is part of the *Control Set up* group.

This is the highest value of output beyond which you do not want the controller automatic output to exceed. Use 0 % to 100 % for time proportional output type.

**Range of Setting:**     -5.0 to 105 % of Output (Current)  
                                      0.0 to 100.0 % of Output (Relay)

---

### 12.2.62     **OUT Lo**     (LOW OUTPUT LIMIT)

This prompt is part of the *Control Set up* group.

This is the highest value of output below which you do not want the controller automatic output to exceed. Use 0 % to 100 % for time proportional output type.

**Range of Setting:**     -5.0 to 105 % of Output (Current)  
                                      0.0 to 100.0 % of Output (Relay)

---

### 12.2.63     **PARITY**     (PARITY)

This prompt is part of the *Communications Set up* group.

**PARITY** pertains to the use of a self-checking code employing binary digits in which the total number of ONE's (or ZERO's) in each permissible code expression is either **ODD** or **EVEN**.

---

**12.2.64 PB or GAIN** (PROPORTIONAL BAND or GAIN)

This prompt is part of the *Tuning* Set up group.

**PROPORTIONAL BAND** is the percent of the range of the measured variable for which a proportional controller will produce a 100 % change in its output.

**GAIN** is the ratio of output change (%) over the measured variable change (%) that caused it.

$$G = \frac{100 \%}{PB \%}$$

where PB is the proportional band (in %)

If the PB is 20 %, then the Gain is 5. Likewise, a 3 % change in the error signal (SP-PV) will result in a 15 % change in the controller's output due to proportional action. If the gain is 2, then the PB is 50 %.

*Defined as "HEAT" Gain on Duplex models for variations of Heat/Cool applications.*

*The selection of Prop. Band or Gain is made in the Control parameter group under prompt "PB or GN."*

**Range of Setting:** PB = 0.1 to 1000 %

GAIN = 0.01 to 1000

---

**12.2.65 PB 2 or GAIN 2** (PROPORTIONAL BAND 2 or GAIN 2)

This prompt is part of the *Tuning* Set up group.

**PROPORTIONAL BAND 2** is the percent of the range of the measured variable for which a proportional controller will produce a 100 % change in its output.

**GAIN 2** is the ratio of output change (%) over the measured variable change (%) that caused it.

$$G = \frac{100 \%}{PB \%}$$

where PB is the proportional band (in %)

If the PB is 20 %, then the Gain is 5. Likewise, a 3 % change in the error signal (SP-PV) will result in a 15 % change in the controller's output due to proportional action. If the gain is 2, then the PB is 50 %.

*Defined as "COOL" Gain on Duplex models for variations of Heat/Cool applications or for a Second Set of PID constants.*

*The selection of Prop. Band or Gain is made in the Control parameter group under prompt "PB or GN."*

**Range of Setting:** PB 2 = 0.1 to 1000 %

GAIN 2 = 0.01 to 1000

---

**12.2.66 PBoRGN** (PROPORTIONAL BAND UNITS)

This prompt is part of the *Control Set up* group.

Select one of the following for the Proportional (P) term of the PID algorithm:

*Selections**Definitions*

**PB**      **PROPORTIONAL BAND** — Selects units of percent proportional band for the P term of the PID algorithm.

$$\text{Where: } \text{PB \%} = \frac{100 \%}{\text{GAIN}}$$

**GAIN**    **GAIN**— selects the unitless term of gain for the P term of the PID algorithm.

$$\text{Where: } \text{GAIN} = \frac{100 \%}{\text{PB \%}}$$

**12.2.67 PERIOD** (TIMEOUT PERIOD)

This prompt is part of the *Timer Set up* group.

This selection allows you to configure a Time-out period

*Range of Setting:* 0.00 to 99:59 (Hours:Minutes)

**12.2.68 PG END** (PROGRAM TERMINATION STATE)

This prompt is part of the *Setpoint Ramp/Program Set up* group.

The program termination state function determines the status of the controller upon completion of the program.

*Selections**Definitions*

**LAST**      Hold at last Setpoint in program

**FSAF**      Manual Mode/Failsafe Output

**12.2.69 PIDSET** (NUMBER OF TUNING PARAMETER SETS)

This prompt is part of the *Control Set up* group.

This selection lets you choose one or two sets of tuning constants (gain, rate, and reset).

*Selections**Definitions*

- ONE**      **ONE SET ONLY**—Only one set of tuning parameters is available. Configure the values for:  
    Gain (proportional band),  
    Rate,  
    Reset Time, and  
    Cycle Time (if time proportional is used).
- 2KBD**      **TWO SETS KEYBOARD SELECTABLE**—Two sets of tuning parameters can be configured and can be selected at the operator interface or by using the Digital Inputs.
- Press **DISPLAY** key until you see PID SET1 or PID SET2 to switch between sets. Configure the values for:  
    Gain, Rate, Reset, Cycle Time  
    Gain #2, Rate #2, Reset #2, Cycle #2 Time
- 2 PV**      **TWO SETS PV AUTOMATIC SWITCHOVER**—When the process variable is **GREATER** than the value set at prompt SW VAL (Switchover Value), the controller will use Gain, Rate, Reset, and Cycle Time. The active PID SET can be read in the lower display.
- When the process variable is **LESS** than the value set at prompt SW VAL, the controller will use Gain #2, Rate #2, Reset #2, and Cycle #2 Time. The active PID SET can be read in the lower display.
- Other prompts affected: SW VAL
- 2 SP**      **TWO SETS SP AUTOMATIC SWITCHOVER**—When the setpoint is **GREATER** than the value set at prompt SW VAL (Switchover Value), the controller will use Gain, Rate, Reset, and Cycle.
- When the setpoint is **LESS** than the value set at prompt SW VAL, the controller will use Gain #2, Rate #2, Reset #2, and Cycle #2.
- Other prompts affected: SW VAL
-

### 12.2.70 PVSTRT (PV START)

This prompt is part of the *Setpoint Ramp/Program* Set up group.

This function determines whether LSP1 or PV is used as the setpoint when the program is initially changed from HOLD to RUN.

#### *Selections*

#### *Definitions*

- |             |   |
|-------------|---|
| <b>DIS</b>  | <b>DISABLE</b> —When the program is initially changed from HOLD to RUN the present LSP1 value is captured as the default setpoint. If the program is terminated or the power cycled before the program has completed, the LSP1 is used as the control setpoint. The beginning segment uses this value as the initial ramp setpoint.   |
| <b>ENAB</b> | <b>ENABLE</b> — When the program is initially changed from HOLD to RUN the present PV value is captured and used as the beginning setpoint value for the ramp segment. If the program is terminated before completion, the setpoint value will revert back to the PV value captured at the initial HOLD to RUN transition. If the power is cycled before program completion, upon power-up the setpoint is set to the PV value at power-up and when the program is restarted that setpoint value is used initially. |

### 12.2.71 PWROUT (THREE POSITION STEP CONTROL OUTPUT START-UP MODE)

This prompt is part of the *Control* Set up group.

This selection determines what position the motor will be in when powered up (the last one prior to shutdown or in the failsafe position).

#### *Selections*

#### *Definitions*

- |             |   |
|-------------|---|
| <b>LAST</b> | <b>LAST OUTPUT</b> —At power-up in automatic mode, the motor position will be the last one prior to power down. When the unit goes into FAILSAFE, it will stay in automatic mode; motor will <b>not</b> be driven to the configured failsafe position.  |
| <b>FSAF</b> | <b>FAILSAFE OUTPUT</b> —At power-up in manual mode, the motor will be driven to either the 0 % or 100 % output position, whichever is selected at prompt FAILSF. For Burnout/None, when the unit goes into FAILSAFE, it will go to manual mode; motor will be driven to the configured failsafe position. |

**12.2.72 PWR UP** (POWER UP CONTROLLER MODE RECALL)

This prompt is part of the *Control Set up* group.

This selection determines which mode and setpoint the controller will use when the controller restarts after a power loss.

*Selections**Definitions*

<b>MAN</b>	<b>MANUAL, LSP, FAILSAFE OUTPUT</b> —At power-up, the controller will use manual mode with the local setpoint displayed.
<b>ALSP</b>	<b>AUTOMATIC MODE, LAST LSP</b> —At power-up, the controller will use automatic mode with the last local setpoint used before power down displayed.
<b>ARSP</b>	<b>AUTOMATIC MODE, LAST RSP</b> —At power-up, the controller will use automatic mode with the last remote setpoint used before power down displayed.
<b>AMSP</b>	<b>LAST MODE/LAST SETPOINT</b> used before power down
<b>AMLS</b>	<b>LAST MODE/LAST LOCAL SETPOINT</b> on power down.

---

**12.2.73 RATE T** (RATE TIME)

This prompt is part of the *Tuning Set up* group.

**RATE** Time affects the controller's output whenever the deviation is changing; and affects it more when the deviation is changing faster.

*Defined as "HEAT" Rate on Duplex models for variations of Heat/Cool applications.*

*Range of Setting: 0.08 to 10.00 minutes*

*0.08 or less = OFF*

---

**12.2.74 RATE2T** (RATE2 TIME)

This prompt is part of the *Tuning Set up* group.

**RATE 2** Time affects the controller's output whenever the deviation is changing; and affects it more when the deviation is changing faster.

*Defined as "COOL" Rate on Duplex models for variations of Heat/Cool applications or for a Second Set of PID constants.*

*Range of Setting: 0.08 to 10.00 minutes*

*0.08 or less = OFF*

---



---

**12.2.75 RATIO1** (INPUT 1 RATIO)

This prompt is part of the *Input 1* Set up group.  
Select the Ratio value you want on Input 1.

*Range of Setting:* -20.0 to 20.0

---

**12.2.76 RATIO2** (INPUT 2 RATIO)

This prompt is part of the *Input 2* Set up group.  
Select the Ratio value you want on Input 2.

*Range of Setting:* -20.0 to 20.0

---

**12.2.77 RECYCL** (RECYCLES)

This prompt is part of the *Setpoint Ramp/Program* Set up group.  
The recycle number allows the program to recycle a specified number of times from beginning to end.

*Range of Setting:* 0 to 99

---

**12.2.78 RLY TY** (RELAY CYCLE TIME INCREMENT)

This prompt is part of the *Algorithm* Set up group.

**RELAY CYCLE TIME INCREMENT** selection is used only for Time Simplex and Duplex output configurations. This configuration sets the increment size of the relay cycle times in the Tuning Set Up group. The Lockout selection must be set to NONE in order to view this selection.

*Selections**Definitions*

- |             |   |
|-------------|---|
| <b>MECH</b> | <b>ELECTROMECHANICAL RELAY</b> —Cycle time in one-second increments.  |
| <b>S S</b>  | <b>SOLID STATE RELAY</b> —Cycle time in 1/3-second increments. This is useful for solid state relay applications that require shorter cycle times. DO NOT use this setting unless cycle times of less than 1 second are required. |
-

**12.2.79    RESET** (TIMER RESET CONTROL)

This prompt is part of the *Timer Set Up* group.

This selection determines how the timer will be reset.

<i>Selections</i>	<i>Definitions</i>
<b>KEY</b>	Run/Hold key.
<b>AL1</b>	Alarm 1

---

**12.2.80    RN HLD** (RUN/HOLD KEY LOCKOUT)

This prompt is part of the *Tuning Set up* group.

This selection allows you to disable/enable the Setpoint Ramp/Program **RUN/HOLD** key. *“LOCK” must be set to “None”.*

<i>Selections</i>	<i>Definitions</i>
<b>DIS</b>	Disable the <b>RUN/HOLD</b> key
<b>ENAB</b>	Enables the <b>RUN/HOLD</b> key

---

**12.2.81    RPUNIT** (ENGINEERING UNITS FOR RAMP SEGMENTS)

This prompt is part of the *Setpoint Ramp/Program Set up* group.

This selection determines the engineering units for ramp segments.

<i>Selections</i>	<i>Definitions</i>
<b>TIME</b>	Hours:Minutes
<b>EU-M</b>	Rate - Engineering units per minute
<b>EU-H</b>	Rate - Engineering units per hour

---

**12.2.82    RSPSRC** (REMOTE SETPOINT SOURCE)

This prompt is part of the *Control Set up* group.

This selection determines what your Remote setpoint source will be when toggled by the **FUNCTION** key or Digital Input.

<i>Selections</i>	<i>Definitions</i>
<b>NONE</b>	<b>NONE</b> —No remote setpoint.
<b>INP2</b>	<b>INPUT 2</b> —Remote Setpoint is Input 2.

---

**12.2.83    SECUR**    (SECURITY CODE)

This prompt is part of the *Tuning Set up* group.

**SECURITY CODE**—The level of keyboard lockout may be changed in the Set Up mode. Knowledge of a “Security code” may be required to change from one level to another. Select this number here, copy it, and keep it in a secure location.

*Entering “0” disables the security code feature.*

NOTE: The Security Code is for keyboard entry only and is not available via communications.

*Can only be changed if LOCK selection is NONE.*

**.Range of Setting:** 0 to 4095 (Default = 1000)

**12.2.84    SGx RP**    (SEGMENT RAMP - x = Segment Number 1 THROUGH 12)

This prompt is part of the *Setpoint Ramp/Program Set up* group.

A ramp segment is the time it takes to change the setpoint to the next setpoint value in the program.

- Ramps are odd number segments. Segment #1 will be the initial ramp time.

**ATTENTION**

The selection of time or rate is made at prompt “RP UNIT”.

- **.Range of Setting:**

TIME - Hours:Minutes    Range = 0-99 hrs:59 min or

EU-M - Degrees/Minute    Range = 0 to 999

EU-H - Degrees/Hour    Range = 0 to 999

**12.2.85    SGx SP**    (SEGMENT SETPOINT - x = Segment Number 1 THROUGH 12)

This prompt is part of the *Setpoint Ramp/Program Set up* group.

A soak segment is a combination of soak setpoint (value) and a soak duration (see SGx TI).

This is Segment x Soak Setpoint Value

**.Range of Setting:** *within the setpoint limits*

**12.2.86 SGx TI** (SEGMENT DURATION - x = Segment Number 1 THROUGH 12)

This prompt is part of the *Setpoint Ramp/Program Set up* group.

A soak segment is a combination of soak setpoint (see SGx SP) and a soak duration.

This is the Soak Setpoint Duration (Time) of Segment x.

**.Range of Setting:** 0-99 hrs:59 min

---

**12.2.87 SDMODE** (SHED MODE)

This prompt is part of the *Communications Set up* group.

SHED CONTROLLER MODE AND OUTPUT LEVEL—Determines the mode of local control you want when the controller is shed from the communications link.

*Selections*

*Definitions*

- LAST** SAME MODE AND OUTPUT—The controller will return to the same mode (manual or automatic) at the same output level that it had before shed.
  - Man\_** MANUAL MODE, SAME OUTPUT—The controller will return to manual mode at the same output level that it had before shed.
  - FSAF** MANUAL MODE, FAILSAFE OUTPUT—The controller will return to manual mode at the output value selected at Control prompt FAILSAFE.
  - AUTO** AUTOMATIC MODE, LAST SP—The controller will return to the automatic mode and the last setpoint used before shed.
- 

**12.2.88 SHD\_SP** (SHED SETPOINT RECALL)

This prompt is part of the *Communications Set up* group.

The setpoint to be used after Shed is recalled.

*Selections*

*Definitions*

- LSP** Controller will use last local or remote setpoint used.
  - CSP** When in “slave” mode, the controller will store the last host computer setpoint and use it at the Local setpoint. When in “monitor” mode, the controller will shed to the last UDC Local or Remote setpoint used, and the LSP is unchanged.
- 

**12.2.89 SHDTIM** (SHED TIME)

This prompt is part of the *Communications Set up* group.

The number that represents how many sample periods there will be before the controller sheds from communications. Each period equals 1/3 seconds; 0 equals No shed.

**.Range of Setting:** 0 to 255 Sample Periods

---

**12.2.90 SOKDEV** (GUARANTEED SOAK DEVIATION)

This prompt is part of the *Setpoint Ramp/Program* Set up group.

Each soak segment can have a deviation value of from 0 to  $\pm 99$  which guarantees the value for that segment.

**Guaranteed** soak segment values  $>0$  guarantee that the segment's process variable is within the  $\pm$  deviation for the configured soak time. Whenever the  $\pm$  deviation is exceeded, soak timing is frozen.

There are no guaranteed soaks whenever the deviation value is configured to 0 (that is, soak segments start timing soak duration as soon as the soak setpoint is first reached, regardless of where the process variable remains relative to the soak segment).

The value is the number in engineering units, above or below the setpoint, outside of which the timer halts.

**Range of Setting:** 0 to  $\pm 99$ . The decimal location corresponds to input 1 decimal selection.

---

**12.2.91 SP Hi** (SETPOINT HIGH LIMIT)

This prompt is part of the *Control* Set up group.

This selection prevents the local and remote setpoints from going above the value selected here. The setting must be equal to or less than the upper range of input 1 and input 2. Input 2, when configured for remote setpoint, will be restricted to this upper limit.

**Range of Setting:** 0 to 100 % of span input in engineering units with decimal place

---

**12.2.92 SP Lo** (SETPOINT LOW LIMIT)

This prompt is part of the *Control* Set up group.

This selection prevents the local and remote setpoints from going below the value selected here. The setting must be equal to or greater than the lower range of input 1 and input 2. Input 2, when configured for remote setpoint, will be restricted to this lower limit.

**Range of Setting:** 0 to 100 % of span input in engineering units with decimal place

---

**12.2.93 SPPROG** (SETPOINT RAMP/SOAK PROGRAM)

This prompt is part of the *Setpoint Ramp/Program* Set up group.

This selection allows you to disable/enable the Setpoint Ramp/Soak Program function.

*“SPRAMP” and “SPRATE” must be disabled.*

**Selections****Definitions**

**DIS** Disables the Ramp/Soak Program Function. Allows “SPRAMP” or “SPRATE” option to be selected.

**ENAB** Enables the setpoint Ramp/Soak Program Function.

---

**12.2.94 SPRAMP** (SINGLE SETPOINT RAMP)

This prompt is part of the *Setpoint Ramp/Program* Set up group.

This selection allows you to disable/enable the Setpoint Ramp function.

*Make sure you configure a ramp time (TI MIN) and a final setpoint value (FINLSP).*

*“SPPROG” and “SPRATE” must be disabled.*

**Selections****Definitions**

**DIS** Disables the Setpoint Select Function. Allows “SPPROG” or “SPRATE” option to be selected.

**ENAB** Enables the Setpoint Select Function.

---

**12.2.95 SPRATE** (SETPOINT RATE)

This prompt is part of the *Setpoint Ramp/Program* Set up group.

This selection allows you to configure a specific rate of change for any local setpoint change.

*“SPRAMP” and “SPPROG” must be disabled*

**Selections****Definitions**

**DIS** Disables the Setpoint Rate option.

**ENAB** Enables the Setpoint Rate option. SP Rate parameters (EUHRUP, EUHRDN) appear when Rate is enabled.

---

**12.2.96 SP SEL** (SETPOINT SELECT FUNCTION LOCKOUT)

This prompt is part of the *Tuning* Set up group.

This selection allows you to disable/enable the Setpoint Select function.

“*LOCK*” must be set to “*NONE*”.

<i>Selections</i>	<i>Definitions</i>
<b>DIS</b>	Disables the Setpoint Select Function.
<b>ENAB</b>	Enables the Setpoint Select Function.

**12.2.97 SP TRK** (SETPOINT TRACKING)

This prompt is part of the *Control* Set up group.

The local setpoint can be configured to track either PV or RSP as listed below.

**ATTENTION**

For selections other than NONE, LSP is stored in nonvolatile memory only when there is a mode change; i.e., when switching from RSP to LSP or from Manual to Automatic. If power is lost, then the current LSP value is also lost.

<i>Selections</i>	<i>Definitions</i>
<b>NONE</b>	<b>NO TRACKING</b> —If local setpoint tracking is not configured, the LSP will not be altered when transfer from RSP to LSP is made.
<b>PV</b>	<b>PROCESS VARIABLE</b> —Local setpoint tracks the PV when in manual.
<b>RSP</b>	<b>REMOTE SETPOINT</b> —Local setpoint tracks remote setpoint when in automatic. When the controller transfers out of remote setpoint, the last value of the remote setpoint (RSP) is inserted into the local setpoint.

**12.2.98 START** (TIMER START SELECTION)

This prompt is part of the *Timer* Set up group. This selection allows you to select whether the Timer starts with the keyboard **RUN/HOLD** key or Alarm 2.

<i>Selections</i>	<i>Definitions</i>
<b>KEY</b>	Starts with <b>RUN/HOLD</b> key.
<b>AL2</b>	Starts on Alarm 2.

**12.2.99 STATE** (PROGRAM STATE AT PROGRAM END)

This prompt is part of the *Setpoint Ramp/Program* Set up group.

The program state selection determines the program state after completion.

<i>Selections</i>	<i>Definitions</i>
<b>DIS</b>	Program disabled at program end.
<b>HOLD</b>	Program held at program end.

**12.2.100 STRSEG** (START SEGMENT)

This prompt is part of the *Setpoint Ramp/Program Set up* group.

The start segment number designates the number of the first segment.

*Range of Setting:* 1 to 11

---

**12.2.101 SW VAL** (AUTOMATIC SWITCHOVER VALUE)

This prompt is part of the *Control Set up* group.

This is the value of Process Variable or Setpoint at which the controller will switch from Tuning Constant Set #2 to Set #1.

Only appears when PIDSET selection is configured for either 2 PV or 2 SP.

*Range of Setting:* Value in engineering units within PV or SP range limits

---

**12.2.102 TI MIN** (SINGLE SETPOINT RAMP TIME)

This prompt is part of the *Setpoint Ramp/Program Set up* group.

Enter the number of minutes desired to reach the final setpoint of a single setpoint ramp.

•A ramp time of “0” implies an immediate change of setpoint to the final setpoint.

*Range of Setting:* 0 to 255 minutes

---

**12.2.103 TIMER** (TIMER OPTION)

This prompt is part of the *Timer Set up* group.

This selection enables or disables a configured Time-out period.

<i>Selections</i>	<i>Definitions</i>
-------------------	--------------------

<b>ENAB</b>	Enables the Timer option.
-------------	---------------------------

<b>DIS</b>	Disables the Timer option.
------------	----------------------------

---

**12.2.104 ToBEGN** (RESET PROGRAMMING TO BEGINNING)

This prompt is part of the *Setpoint Ramp/Program Set up* group.

This selection enables or disables programming reset.

<i>Selections</i>	<i>Definitions</i>
-------------------	--------------------

<b>DIS</b>	Disables programming reset.
------------	-----------------------------

<b>KEY</b>	Allows programming reset from the keyboard.
------------	---

---



---

**12.2.105 TUNE** (ACCUTUNE - DEMAND TUNING)

This prompt is part of the *Accutune* Set up group.

If **TUNE** is selected, and tuning is initiated through the operator interface or digital input (if configured), the algorithm calculates new tuning parameters and enters them into the tuning group. This tuning requires no process knowledge and does not require line out for initialization.

***Selections***                      ***Definitions***

**DIS**            Disable Accutune.

**ENAB**        Enables Accutune.

---

**12.2.106 TX DLY** (RESPONSE DELAY)

This prompt is part of the *Communications* Set up group.

**TX DELAY**—Configurable response-delay timer allows you to force the UDC to delay its response for a time period of from 1 to 500 milliseconds compatible with the host system hardware/software.

*Range of Setting: 1 to 500 milliseconds*

---

**12.2.107 UNITS** (COMMUNICATION OVERRIDE UNITS)

This prompt is part of the *Communications* Set up group.

This selection determines how the controller values are expressed during communications.

***Selections***                      ***Definitions***

**PCT**            Percent

**ENG**            Engineering units

---

**12.2.108 UNITS** (TEMPERATURE UNITS)

This prompt is part of the *Input 1* Set up group.

This selection will be indicated on the annunciator—what display of temperature you want.

***Selections***                      ***Definitions***

**F**                Degrees Fahrenheit

**C**                Degrees Centigrade

**NONE**        None

**12.2.109 XMITR1** (TRANSMITTER CHARACTERIZATION)

This prompt is part of the *Input 1* Set up group.

This selection lets you instruct the controller to characterize a linear input to represent a non-linear one.

**ATTENTION**

Prompt only appears when a linear actuation is selected at prompt IN1TYP.

FOR EXAMPLE:

If input 1 is a 4 to 20 mA signal, but the signal represents a type K thermocouple, select K H and the controller will characterize the 4 to 20 mA signal so that it is treated as a type K thermocouple input (high range).

<i>Selections</i>	<i>Definitions</i>
<b>B</b>	<b>B</b> —B Thermocouple
<b>E H</b>	<b>E H</b> —E Thermocouple High
<b>E L</b>	<b>E L</b> —E Thermocouple Low
<b>J H</b>	<b>J H</b> —J Thermocouple High
<b>J L</b>	<b>J L</b> —J Thermocouple Low
<b>K H</b>	<b>K H</b> —K Thermocouple High
<b>K L</b>	<b>K L</b> —K Thermocouple Low
<b>NNMH</b>	<b>NNMH</b> —Ni-Ni-Moly Thermocouple High
<b>NNML</b>	<b>NNML</b> —Ni-Ni-Moly Thermocouple Low
<b>N90H</b>	<b>N90H</b> —NiMo-NiCo Thermocouple High
<b>N90L</b>	<b>N90L</b> —NiMo-NiCo Thermocouple Low
<b>NIC</b>	<b>NIC</b> —Nicrosil-Nisil Thermocouple
<b>R</b>	<b>R</b> —R Thermocouple
<b>S</b>	<b>S</b> —S Thermocouple
<b>T H</b>	<b>T H</b> —T Thermocouple High
<b>T L</b>	<b>T L</b> —T Thermocouple Low
<b>W H</b>	<b>W H</b> —W5W26 Thermocouple High
<b>W L</b>	<b>W L</b> —W5W26 Thermocouple Low
<b>100H</b>	<b>100H</b> —100 Ohm RTD High
<b>100L</b>	<b>100L</b> —100 Ohm RTD Low
<b>200</b>	<b>200</b> —200 Ohm RTD
<b>500</b>	<b>500</b> —500 Ohm RTD
<b>RADH</b>	<b>RADH</b> —Radamatic RH
<b>RADI</b>	<b>RADI</b> —Radamatic RI
<b>LIN</b>	<b>LIN</b> —Linear
<b>SrT</b>	<b>SrT</b> —Square Root

**12.2.110 XMITR2** (TRANSMITTER CHARACTERIZATION)

This prompt is part of the *Input 2* Set up group.

This selection lets you instruct the controller to characterize a linear input to represent a non-linear one.

**ATTENTION**

Prompt only appears when a linear actuation is selected at prompt IN2TYP.

FOR EXAMPLE:

If input 2 is a 4 to 20 mA signal, but the signal represents a type K thermocouple, select K H and the controller will characterize the 4 to 20 mA signal so that it is treated as a type K thermocouple input (high range).

<i>Selections</i>	<i>Definitions</i>
<b>B</b>	<b>B</b> —B Thermocouple
<b>E H</b>	<b>E H</b> —E Thermocouple High
<b>E L</b>	<b>E L</b> —E Thermocouple Low
<b>J H</b>	<b>J H</b> —J Thermocouple High
<b>J L</b>	<b>J L</b> —J Thermocouple Low
<b>K H</b>	<b>K H</b> —K Thermocouple High
<b>K L</b>	<b>K L</b> —K Thermocouple Low
<b>NNMH</b>	<b>NNMH</b> —Ni-Ni-Moly Thermocouple High
<b>NNML</b>	<b>NNML</b> —Ni-Ni-Moly Thermocouple Low
<b>N90H</b>	<b>N90H</b> —NiMo-NiCo Thermocouple High
<b>N90L</b>	<b>N90L</b> —NiMo-NiCo Thermocouple Low
<b>NIC</b>	<b>NIC</b> —Nicrosil-Nisil Thermocouple
<b>R</b>	<b>R</b> —R Thermocouple
<b>S</b>	<b>S</b> —S Thermocouple
<b>T H</b>	<b>T H</b> —T Thermocouple High
<b>T L</b>	<b>T L</b> —T Thermocouple Low
<b>W H</b>	<b>W H</b> —W5W26 Thermocouple High
<b>W L</b>	<b>W L</b> —W5W26 Thermocouple Low
<b>100H</b>	<b>100H</b> —100 Ohm RTD High
<b>100L</b>	<b>100L</b> —100 Ohm RTD Low
<b>200</b>	<b>200</b> —200 Ohm RTD
<b>500</b>	<b>500</b> —500 Ohm RTD
<b>RADH</b>	<b>RADH</b> —Radamatic RH
<b>RADI</b>	<b>RADI</b> —Radamatic RI
<b>LIN</b>	<b>LIN</b> —Linear
<b>SrT</b>	<b>SrT</b> —Square Root



## 13 Index

### A

Aborting Accutune, 63  
 Accuracy, 4  
 ACCUTUNE - DEMAND TUNING, 157  
 Accutune Error Codes, 31, 63  
 ACCUTUNE ERROR CODES, 121  
 Accutune II, 61  
 Accutune Set Up Group, 31  
 Alarm and Duplex Output Connections, 17, 19  
 Alarm Blocking, 42  
 ALARM BLOCKING, 126  
 Alarm Hysteresis, 42  
 ALARM HYSTERESIS, 121  
 Alarm Relay Action., 6  
 Alarm Relay Output failure, 112  
 Alarm Relays, 8  
 Alarm Setpoints, 66  
 Alarm Setpoints Display, 66  
 Alarms Set Up Group, 41  
 Alarmx Segment Event x, 42  
 Alarmx Setpoint x State, 42  
 ALARMx SETPOINTx EVENT, 123  
 ALARMx SETPOINTx STATE, 123  
 Alarmx Setpointx Type, 41  
 ALARMx SETPOINTx TYPE, 124  
 Alarmx Setpointx Value, 41  
 ALARMx SETPOINTx VALUE, 125  
 Algorithm Set Up Group, 32  
 Ambient Temperature, 4  
 Annunciators, 49  
 Application related problems, 102  
 ATUNE Group, 31  
 Auto/Manual key, 48  
 Auto/Manual Key Lockout, 28  
 AUTO/MANUAL KEY LOCKOUT, 121  
 Automatic Switchover Value, 36  
 AUTOMATIC SWITCHOVER VALUE, 156  
 AUTOMATIC with LOCAL SETPOINT, 57  
 AUTOMATIC with REMOTE SETPOINT, 57  
 Auto-only Mode, 54  
 Autotune is complete, 63  
 Autotune key, 48  
 Autotune Key Lockout, 28  
 AUTOTUNE KEY LOCKOUT, 120  
 Auxiliary Output, 38  
 AUXILIARY OUTPUT, 122  
 Auxiliary Output Calibration, 98  
 Auxiliary Output Calibration Procedure, 99  
 AUXILIARY OUTPUT HIGH SCALING FACTOR,  
 119

AUXILIARY OUTPUT LOW SCALING FACTOR,  
 119

### B

Background tests, 105  
 Baud Rate, 39  
 BAUD RATE, 125  
 Bias on Input 1, 34  
 Bias on Input 2, 35  
 Burnout Protection, 34  
 BURNOUT PROTECTION, 126

### C

Calibration Mode, 94  
 Calibration Steps, 84  
 CE Conformity, 4  
 CE Conformity (Europe), 2  
 Changing Control Modes, 58  
 Changing the Local Setpoints, 58  
 COMMUNICATION OVERRIDE UNITS, 157  
 Communications Override Units, 40  
 Communications State, 39  
 COMMUNICATIONS STATE, 127  
 Composite Wiring Diagram, 13  
 Computer Setpoint Bias, 40  
 COMPUTER SETPOINT BIAS, 127  
 Computer Setpoint Ratio, 40  
 COMPUTER SETPOINT RATIO, 129  
 Configuration, 23  
 Configuration Procedure, 25  
 Configuration Prompt Hierarchy, 24  
 Control Algorithm, 32  
 CONTROL ALGORITHM, 127  
 Control and Alarm Relay Contact Information, 8  
 Control Modes, 57  
 Control Output Direction, 36  
 CONTROL OUTPUT DIRECTION, 120  
 Control Relay 1, 6  
 Control Relay 2, 6  
 Control Relays, 8  
 Control Set Up Group, 36  
 Control/Alarm Circuit Wiring, 11  
 Controller Failure Symptoms, 107  
 Controller Grounding, 11  
 Current Duplex Range, 32  
 CURRENT DUPLEX RANGE, 119  
 Current Output, 6, 16  
 Current Proportional Output Calibration, 96  
 Current Proportional Output Failure, 109

Current/Time or Time/Current Proportional Output failure, 111

Customer support, 103

CYCLE TIME - HEAT, 129

Cycle Time (Cool), 28

Cycle Time (Heat), 28

CYCLE TIME2 - COOL, 130

## **D**

Deadband, 37

DEADBAND, 130

DECIMAL POINT LOCATION, 130

Decimal Point Selection, 33

Demand Tuning, 31

Digital Input, 38

DIGITAL INPUT, 131

Digital input (remote) operation, 81

Digital Input Combinations, 38

DIGITAL INPUT COMBINATIONS, 131

Dimensions, 9

DISPLAY FOR TIMER OPTION, 140

DOWNSCALE BURNOUT, 126

Duplex Control, 62

## **E**

ELAPSED TIME, 60

Electrical Considerations, 11

Electrical Noise Precautions, 11

Electromechanical Relay Output, 14

Emissivity, 34

EMISSIVITY, 133

END SEGMENT, 133

End segment number, 75

End Segment Number, 29

Engineering units for Ramp Segments, 30

ENGINEERING UNITS FOR RAMP SEGMENTS, 150

equipment you will need to calibrate, 86

Error Codes, 63

Error Messages, 51

Estimated Motor Position, 67

External Interface Option Connections, 18

External Solid State Relay Option, 16

*External Wiring*, 11

## **F**

Factory calibration, 93

Failsafe Function Prompt, 68, 69

Failsafe Manual Mode, 21, 104

Failsafe Mode, 37, 69

FAILSAFE MODE, 135

Failsafe Output Value, 37

FAILSAFE OUTPUT VALUE, 68, 134

Failsafe Output Value for Restart After a Power Loss, 68

features, 1

Field Wiring, 85

Filter for Input 1, 34

Filter for Input 2, 35

Function Parameter Reference Guide, 117

Function Prompts, 24

Fuzzy Overshoot Suppression, 31, 64

FUZZY OVERSHOOT SUPPRESSION, 135

## **G**

Guaranteed soak, 76

GUARANTEED SOAK DEVIATION, 153

Guaranteed Soak Deviation Value, 30

## **H**

High Output Limit, 37

HIGH OUTPUT LIMIT, 143

High Scaling Factor, 38

Hysteresis, 37

HYSTERESIS - OUTPUT RELAY ONLY, 135

## **I**

Initial Start-up, 21

Input 1 Actuation Type, 33

INPUT 1 ACTUATION TYPE, 138

Input 1 and Input 2 Wiring Terminals, 85

INPUT 1 BIAS, 125

Input 1 Calibration Procedure, 89

Input 1 Connections, 14

INPUT 1 FILTER, 134

Input 1 High Range Value, 34

INPUT 1 HIGH RANGE VALUE, 137

Input 1 Low Range Value, 34

INPUT 1 LOW RANGE VALUE, 137

INPUT 1 RATIO, 149

Input 1 Set Up Group, 33

Input 1 Set Up Wiring, 87

Input 2 (RSP) Jumper Placement, 6

INPUT 2 ACTUATION TYPE, 140

INPUT 2 BIAS, 125

Input 2 Calibration Procedure, 92

Input 2 Connections, 14

INPUT 2 FILTER, 134

Input 2 High Range Value, 35

INPUT 2 HIGH RANGE VALUE, 139

Input 2 Low Range Value, 35

INPUT 2 LOW RANGE VALUE, 139

INPUT 2 RATIO, 149

Input 2 Set Up Group, 35

Input 2 Set Up Wiring, 91

Input 2 Type, 35

Input Calibration, 83  
 Input I Jumper Placement, 6  
 Installation, 3  
 Installation related problems, 102  
 Internal Open Collector Output, 16

**J**

Jumper for Input 1, 86  
 Jumper for Input 2, 86  
 Jumper Placement, 7

**K**

Key error, 48  
 Key Error Message, 22  
 Key Functions, 22  
 key lockout, 48  
 Keyboard failure, 113

**L**

LANGUAGE, 140  
 Language Selection, 34  
 Latching, 69  
 Latching Alarm for Output, 42  
 LATCHING ALARM FOR OUTPUT, 120  
 Local Loopback Test, 40  
 LOCAL LOOPBACK TEST, 141  
 Local Setpoint Source, 36  
 LOCAL SETPOINT SOURCE, 141  
 Lockout, 28  
 LOCKOUT, 141  
 lockout feature, 47  
 Lockout levels, 47  
 Low Output Limit, 37  
 LOW OUTPUT LIMIT, 143  
 Low Scaling Factor, 38  
 Lower Display Key Parameter Prompts, 50

**M**

Mains Power Supply, 11, 13  
 MANUAL, 57  
 Manual Reset, 27  
 MANUAL RESET, 142  
 Mechanical Shock, 4  
 Minimum and Maximum Range Values, 84  
 Model Number Interpretation, 5  
 Monitoring t, 45  
 Motor Position Display, 67  
 Motor Time, 100  
 Mounting, 9  
 Mounting Method, 10  
 Mounting Procedure, 10

**N**

Non-Latching, 69  
 Number of Program Recycles, 30  
 Number of Tuning Parameter Sets, 36  
 NUMBER OF TUNING PARAMETER SETS, 146

**O**

Open Collector Relay Output, 15  
 Operating Limits, 4  
 operating parameters, 50  
 Operation, 53  
 Operator Interface, 1, 22, 46  
 Output Algorithm, 32  
 OUTPUT ALGORITHM, 142  
 Output Calibration, 95

**P, Q**

Parity, 39  
 PARITY, 143  
 Parts Identification, 115  
 Parts List, 115  
 Permissible Wiring Bundling, 12  
 Physical Considerations, 9  
 Position proportional or 3 position step test failures, 104  
 Power, 4  
 Power Consumption, 4  
 power failure symptoms, 109  
 Power Line Frequency, 34  
 POWER LINE FREQUENCY, 135  
 Power outage, 81  
 Power Outage, 73  
 Power Up Controller Mode Recall, 36  
 POWER UP CONTROLLER MODE RECALL, 148  
 Powering Up, 21  
 Power-up Tests, 104  
 Pre-installation Information, 4  
 Preliminary Checks, 6  
 Program Contents, 74  
 Program record sheet, 79  
 Program state, 76  
 Program State at Program End, 30  
 PROGRAM STATE AT PROGRAM END, 155  
 Program termination state, 76  
 Program Termination State, 30  
 PROGRAM TERMINATION STATE), 145  
 Proportional Band 2 or Gain 2, 27  
 PROPORTIONAL BAND 2 or GAIN 2, 144  
 Proportional Band or Gain, 27  
 PROPORTIONAL BAND or GAIN, 144  
 Proportional Band Units, 37  
 PROPORTIONAL BAND UNITS, 145  
 PV Hot Start, 71

**R**

Ramp time or rate segments, 75  
Ramp unit, 75  
Ramp/soak profile example, 77  
Rate 2 in Minutes, 27  
Rate Down, 29  
RATE DOWN VALUE, 133  
Rate in Minutes, 27  
RATE TIME, 148  
Rate Up, 29  
RATE UP VALUE, 133  
RATE2 TIME, 148  
Ratio on Input 1, 34  
Ratio on Input 2, 35  
Recycle number, 75  
RECYCLES, 149  
Relative Humidity, 4  
Relay Cycle Time Increment, 32  
RELAY CYCLE TIME INCREMENT, 149  
Remote Setpoint Source, 36  
REMOTE SETPOINT SOURCE, 150  
RESET - INTEGRAL TIME, 136  
Reset in minutes/repeat, 27  
Reset in repeats/minute, 27  
Reset Program to Beginning, 76  
Reset Program to the Beginning, 30  
RESET PROGRAMMING TO BEGINNING, 156  
Reset Units, 37  
RESET UNITS, 142  
RESET2 - INTEGRAL TIME, 136  
Response Delay, 39  
RESPONSE DELAY, 157  
Restore Factory Calibration, 93  
RTD Inputs, 88  
Run/Hold key, 48  
RUN/HOLD key, 71  
Run/Hold Key Lockout, 28  
RUN/HOLD KEY LOCKOUT, 150  
Run/Monitor the program, 80

**S**

Security Code, 28, 46  
SECURITY CODE, 151  
SEGMENT DURATION, 152  
SEGMENT RAMP, 151  
Segment Ramp or Rate Time, 30  
SEGMENT SETPOINT, 151  
Segment Soak Duration, 30  
Segment Soak Setpoint Value, 30  
Set Point Select function key, 48  
Set Up Group, 24  
Set Up groups, 23  
Set Up Wiring Procedure for Auxiliary Output, 98  
Setpoint High Limit, 36

SETPOINT HIGH LIMIT, 153  
Setpoint Low Limit, 36  
SETPOINT LOW LIMIT, 153  
Setpoint Ramp, 29, 72  
Setpoint Ramp Final Setpoint, 29  
SETPOINT RAMP/SOAK PROGRAM, 154  
Setpoint Ramp/Soak Programming, 29, 74  
Setpoint Rate, 29, 72  
SETPOINT RATE, 154  
Setpoint Rate/Ramp/Program Operation, 71  
Setpoint Select Function Lockout, 28  
SETPOINT SELECT FUNCTION LOCKOUT, 155  
Setpoint Tracking, 36  
SETPOINT TRACKING, 155  
Setpoints, 58  
SHED MODE, 152  
Shed Output Mode, 40  
Shed Setpoint Recall, 40  
SHED SETPOINT RECALL, 152  
Shed Time, 39  
SHED TIME, 152  
Shock hazard warning, 108  
SINGLE DISPLAY DEFAULT, 133  
Single Display Functionality, 54  
Single Display Parameters, 55  
SINGLE SETPOINT RAMP, 154  
SINGLE SETPOINT RAMP FINAL SETPOINT, 134  
Single Setpoint Ramp Time, 29  
SINGLE SETPOINT RAMP TIME, 156  
Soak segments, 75  
software version number, 103  
Solid State Relay Output, 15  
SP RAMP, 29  
SP Ramp Set Up Group, 29  
Specifications, 4  
SPPROG, 29  
SPRATE, 29  
Start Segment, 29  
START SEGMENT, 156  
Start segment number, 75  
Start Segment Number, 29  
start up, 21  
Start Up Procedure for Operation, 56  
Station Address, 39  
STATION ADDRESS, 127  
Status Tests, 104  
*Suppression Devices*, 11  
Switch between two sets via keyboard, 65  
Switching between setpoints, 59

**T**

Temperature Units, 33  
TEMPERATURE UNITS, 157



- Test Failures, 21, 104
  - Thermocouple Inputs Using a Thermocouple Source, 87
  - Thermocouple Inputs Using an Ice Bath, 87
  - Three position step control, 100
  - Three Position Step Control, 36
  - Three Position Step Control algorithm, 67
  - Three Position Step Control Connections, 17
  - THREE POSITION STEP CONTROL OUTPUT START-UP MODE, 147
  - TIME COUNT INCREMENT, 136
  - Time Proportional Output failure, 110
  - TIME REMAINING, 60
  - TIME-OUT, 60
  - Time-out Period, 26
  - TIMEOUT PERIOD, 145
  - Timer, 59
  - Timer Count Increment, 26
  - Timer Display, 26
  - Timer Function Start, 26
  - TIMER OPTION, 156
  - Timer Reset Control, 26
  - TIMER RESET CONTROL, 150
  - Timer Set Up Group, 26
  - TIMER START SELECTION, 155
  - Transmitter Characterization, 33
  - TRANSMITTER CHARACTERIZATION, 158, 159
  - Transmitter Characterization for, 35
  - Troubleshooting Aids, 102
  - troubleshooting procedures, 108
  - Troubleshooting/Service, 101
  - TUNE, 31, 61
  - Tune for Duplex (Heat/Cool), 62
  - Tuning, 27
  - Tuning indicators, 61
  - Tuning Set Up Group, 27
  - Two Sets of Tuning Constants, 64
- U**
- Universal Output Functionality and Restrictions, 12
  - UPSCALE BURNOUT, 126
- V**
- Vibration, 4
  - Voltage and Resistance Equivalents for 0% and 100% Range Values, 84
- W, X, Y, Z**
- WARNING—SHOCK HAZARD, 108
  - Wiring, 11
  - Wiring Bundling, 12
  - Wiring Connections for 1 to 5 Volt Input – Input 2, 92
  - Wiring Connections for 4 to 20 mA Input – Input 2, 91
  - Wiring Connections for Calibrating Auxiliary Output, 98
  - Wiring Connections for Calibrating Current Proportional Output, 96
  - Wiring Connections for Radiomatic, Milliampere, Millivolts, or Volts (Except 0 to 10 Volts), 89
  - Wiring Connections for RTD (Resistance Thermometer Device), 88
  - Wiring Diagrams, 12
  - Wiring the Controller, 13
  - worksheet, 74





**Honeywell**

---

**Sensing and Control**  
Honeywell Inc.  
11 West Spring Street  
Freeport, IL 61032