

**IPC5000
Universal Programmable
Controller
Installation Manual**

57-77-25-19

Notice

Copyright 2007 by Honeywell

Revision 1.29

June 2007

Warranty / Remedy

Honeywell warrants goods of its manufacture as being free of defective materials and faulty workmanship. Contact your local sales office for warranty information. If warranted goods are returned to Honeywell during the period of coverage, Honeywell will repair or replace without charge those items it finds defective. The foregoing is Buyer's sole remedy and is **in lieu of all other warranties, expressed or implied, including those of merchantability and fitness for a particular purpose**. Specifications may be changed without notice. The information we supply is believed to be accurate and reliable as of this printing. However, we assume no responsibility for its use.

While we provide application assistance personally, through our literature and the Honeywell web site, it is up to the customer to determine the suitability of the product in their application.

Industrial Measurement and Control

Honeywell Pte LTD

Honeywell Building

17 Changi Business Park Central 1

Singapore

To the Users

Thank you for purchasing IPC5000 (Universal Programmable Controller). This manual describes how to install and use IPC5000. To optimize the control solutions for furnaces, environmental chambers, ovens, reactors, cookers, freeze dryers, extruders, and other processes with similar control requirements, please read this manual carefully.

Warning



1. Keep the manual with the programmer so that a user can operate it properly.
 2. Handle this product only after you have carefully read and understand the installation manual.
 3. Honeywell does not bear responsibility for any damage inflicted by careless use of the product.
 4. This manual cannot be duplicated, re-edited or transferred in any form fully or partially without a prior consent from Honeywell. The content of this manual can be modified without prior notice.
 5. Please contact Honeywell if you have any questions or queries regarding this manual.
-
-

Safety Points

- **Explanation of symbols used**

Pictures and rules described below indicate potential danger that can injure the user or the product. Before reading the main text of the manual, please become familiar with the following symbols that indicate various degrees of damage.

- **Examples of symbols**

	This CAUTION symbol on the equipment refers the user to the product manual for additional information. This symbol appears next to required information in the manual.
	WARNING PERSONAL INJURY: Risk of electrical shock. This symbol warns the user of a potential shock hazard where HAZARDOUS LIVE voltages greater than 30 Vrms, 42.4 Vpeak, or 60 Vdc may be accessible. Failure to comply with these instructions could result in death or serious injury.
	Protective Earth (PE) terminal. Provided for connection of the protective earth (green or green/yellow) supply system conductor.

Points to check when unpacking the product:

The **IPC5000** consists of the following items.

Please, check the following items when unpacking the product:

1. Verify the model number is correct;
2. Whether the product has been damaged;
3. Whether the container includes all the ordered items.

Points to check when installing the product:

If any of the following components are missing or if the product is damaged after you unpack it, contact Honeywell.

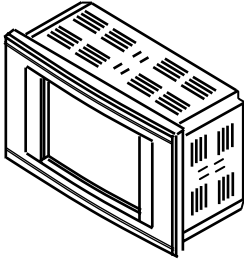
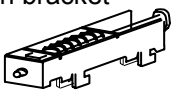
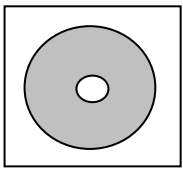
Name	Model number	Quantity	Remarks
Main frame 	IPC5000	1	Refer to the Section 5(Model Number Interpretation)
Installation bracket 	10-03057	4	
CD for installation 		1	PC Software(Setup program) PC Software User Manual(English) PC Software Install Manual(English) PC Software User Manual(Korean) PC Software Install Manual(Korean) IPC5000 User Manual(English) IPC5000 Install Manual(English) IPC5000 User Manual(Korean) IPC5000 Install Manual(Korean) IPC5000 Communication Manual(English) IPC5000 Communication Manual(Korean)

Contents

1. Overview	1
1.1 Introduction	1
1.2 Feature Summary.....	1
2. Installation and wiring	2
2.1 Installation environment.....	2
2.2 Installation precautions.....	3
2.3 Panel cutout dimension	4
2.4 Installation of fixed brackets.....	6
2.5 Making Terminal Connections	8
2.6 Terminal Array	9
2.7 Wiring.....	10
2.7 Terminal Allocation	25
2.8 Rear terminal	26
3. Configuration	27
3.1 Screen configuration	27
3.2 Configuration screen	28
3.3 AI SET screen	29
3.4 PWM set Screen	35
3.5 AO SET screen	37
3.6 DIO status screen.....	40
3.7 RANGE SET screen	45
3.8 OFFSET screen	47
3.9 Compensation set screen	48
3.10 EVENT SET	50
3.11 MODE Event set screen.....	53
3.12 ALARM EVENT SET screen.....	56
3.13 CONTROL SET screen.....	60
3.14 PID ZONE SET screen	63
3.15 PID CONSTANT SET screen.....	67
3.16 PID set screen	69
3.17 SYSTEM SET screen.....	71
3.18 TROUBLE SET Screen.....	75
3.19 TROUBLE MESSAGE set.....	78

3.20 NETWORK SET Screen.....	79
3.21 INITIALIZE screen	80
4. Specification	82
5. Model Number Interpretation.....	90

Tables

Table 2.7.1 Minimum Recommended Wire Sizes	10
Table 2.7.2 Instrument input range code and range	21
Table 2.7.3 The function table of External switch input (Digital input)	23
Table 3.6.1 Defaults of compensation	48
Table 3.11.1 Mode Event information	53
Table 3.11.2 DO information assigned by REGISTRATION number	55
Table 3.12.1 Alarm Event Flowchart	58
Table 3.12.2 Alarm Event On/Off Operation Algorithm	59
Table 3.21.1 Initial PID parameter list	81

Figures

Fig. 2.3.1 Panel cutout	4
Fig. 2.4.1 Installation of fixed brackets	6
Fig. 2.5.1 Terminal with tube	8
Fig. 2.5.2 Terminal diagram label and Terminal Block style	9
Fig. 2.6.1 Mains Power Supply	11
Fig. 2.6.2 Analog input 1 / input 2 Connections	12
Fig. 2.6.3 Control output 1 / output 2 Connections	13
Fig. 2.6.4 Digital outputs Connection	14
Fig. 2.6.5 Digital inputs Connections	15
Fig. 2.6.6 Auxiliary output 3 output 4 Connections	16
Fig. 2.6.7 RS-232C communication 9 pin Connection	16
Fig. 2.6.8 RS-232C communication 25 to 9 pin Connection	17
Fig. 2.6.9 RS422/485/Modbus Communications Option Connections (3-Wire shield)	18
Fig. 2.6.10 RS422/485/Modbus Communications Option Connections (5-Wire shield)	19
Fig. 2.8.1 Rear Terminal	26
Fig. 3.1.1 Screen switch block	27
Fig. 3.1.2 Main menu screen	28
Fig. 3.2.1 SETUP (Configuration)	28
Fig. 3.3.1 AI SET Screen	29
Fig. 3.3.2 SENSOR TYPE SELECTS	29
Fig. 3.4.1.a Outputs Assigning block diagram-IPC5000D	33
Fig. 3.4.1.b Outputs Assigning block diagram-IPC5000S	34
Fig. 3.4.2 PWM SET screen-IPC5000S	35
Fig 3.4.4 Pulse control output at MV = 75%	36
Fig. 3.5.1 AO SET screen	37
Fig. 3.5.2 Combo box for selecting analog output source	39
Fig. 3.5.3 Current output scale adjustable graph	39
Fig. 3.6.1 DI/DO Screen	40
Fig. 3.6.2 Digital outputs ON/OFF status	43
Fig. 3.6.3 Digital output type selection	43
Fig. 3.6.4 DO TYPE SET screen	44
Fig. 3.6.5 Arranging PWM No. of Digital output	44
Fig. 3.7.1 RANGE SET screen	45
Fig. 3.8.1 OFFSET screen	47
Fig. 3.9.1 Compensate set screen	48

Fig. 3.10.1 The part to arrange events to digital outputs on FIX SET screen of User Manual	51
Fig. 3.10.2 The part to arrange PV and Time events to digital outputs on SEG EDIT screen of User Manual	52
Fig. 3.11.1 MODE EVENT SET	53
Fig. 3.12.1 ALARM SET screen	56
Fig. 3.13.1 CONTROL SET screen	60
Fig. 3.13.2 PID ZONE Set screen	61
Fig. 3.13.3 Example for setting Segment PID group	62
Fig. 3.14.1 PID ZONE SET screen	63
Fig. 3.15.1 PID Const set	67
Fig. 3.16.1 PID SET screen	69
Fig. 3.17.1 SYSTEM SET screen	71
Fig. 3.17.2 Fix Control Operation when SP Tracking On and JC = 2	72
Fig. 3.17.3 Fix Control Operation when SP Tracking Off and JC = 2	72
Fig. 3.18.1 Trouble and Tune Lock Setting Screen	75
Fig. 3.18.2 Trouble Message Window	76
Fig. 3.18.3 Trouble Message List	76
Fig. 3.18.4 MON SUB Screen	77
Fig. 3.19.1 Assigning the TROUBLE MESSAGE	78
Fig. 3.19.2 Keypad Switching	78
Fig. 3.20.1 Network Setting Screen	79
Fig. 3.21.1 INITIAL screen	80
Fig. 3.21.2 Confirm for initializing	80

1. Overview

1.1 Introduction

The IPC5000 is a universal programmable microprocessor-based, a single loop or two-loop controller. It has a typical accuracy of ± 0.10 % of span, two analog control loops, 12 digital inputs and outputs, 100 programs and 2000 segments. The IPC5000 is an ideal control solution for furnaces, dryers and environmental chambers, corrosion testing chambers, lab ovens, sterilizers and other processes with similar control requirements.

1.2 Feature Summary

- IPC5000D support two mode; Synchronous and Asynchronous mode
 - Synchronous: depending on TIME each loop
 - Asynchronous mode: independent on time each loop
- 1 or Up to 2 loops, including:
 - Proportional Integral Derivative (PID),
 - ON/OFF and,
 - Heating/Cooling control
- Auto tuning for each control loop and automatic tuning for all zones (Max. 8 zones).
- Up to 36 different selection for 2 analog inputs
- 2 universal control output (Voltage pulse, Current (4~20mA), Relay)
- 12 digital inputs and 12 digital outputs
- Up to 100 programs, total 2000 segments
- Easy operator interface by touch screen and graphic displays by LCD.
- Universal Power(100 to 240 VAC) or 37 VA
- Ethernet communication (Option)
- Y2K compliant

<IPC5000S>

- Up to 36 selection for 1 analog input

2. Installation and wiring

2.1 Installation environment

Panel mounted, indoor Process Control Equipment; Pollution degree 2, Installation Category II



Warning

In order to enhance the product's credibility and give full scope to IPC5000 functions, **do not install** the product in the following places.

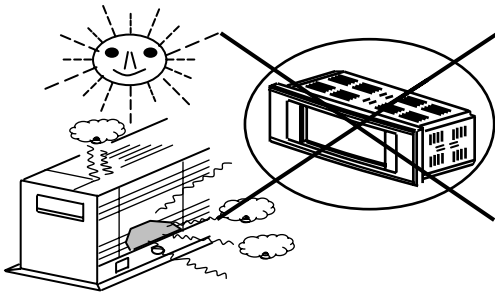

- Place where temperature exceed 50°C(122°F)
- Place exposed to direct sunlight
- Outdoors

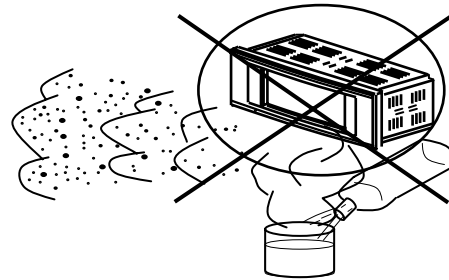

- Places exposed to corrosive or flammable gases
- Place with dust, salinity, iron powder and other conductible substances and organic solvents

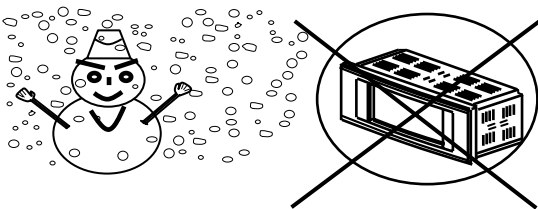

- Places with a sub-zero temperature (below 0°C)

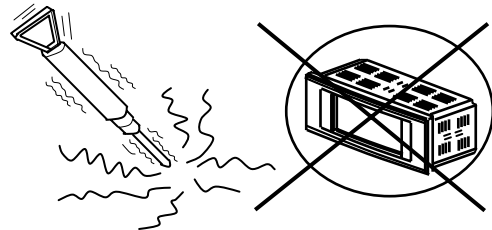

- Places susceptible to vibration and shock

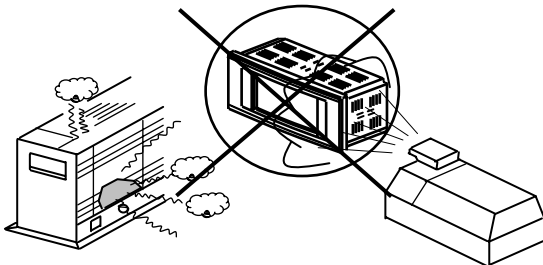

- Places with humidity of over 85%
- Places with abrupt temperature changes that cause dewdrops
- Place exposed to water, oil or chemical substances

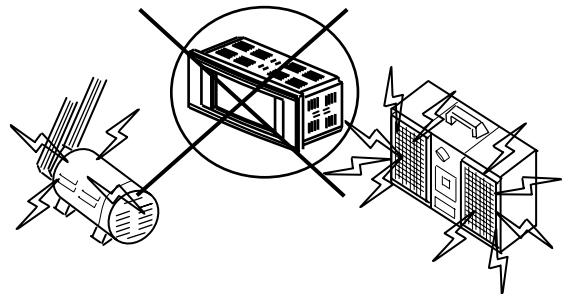

- Places exposed to strong electromagnetic fields

2.2 Installation precautions

This section describes precautions that should be taken when installing IPC5000 (Universal Programmable controller). It is essential to consider environmental stress, cracking resistance and operability.

- 1) Provide sufficient space for ventilation.
- 2) Do not install right above devices inside the panel that generate excessive heat such as (transformers, large-capacity resistors).
- 3) Install far from high-voltage devices, power devices or their cables, or install in a separate panel.
- 4) Use exclusive grounding to deal with noise. If the grounding cable is long enough to reach the grounding point, use a thick insulated wire and ground to earth ground.
- 5) Do not bind communications or data cables of IPC5000 with the cables of power devices or other cables that cause noise. When wiring in an identical duct, connect a shield cable to the FG terminal of the main frame.
- 6) Select a flat installation panel with no curves
- 7) If you want to use the product after having kept it in temperatures below 0 °C, allow it to warm up for at least 30 minutes at room temperature by connecting the power supply. Otherwise, there is a risk of damaging the product.
- 8) Before you clean the IPC5000, disconnect the IPC5000 from the site AC source. Clean your IPC5000 with a soft cloth dampened with water. Do not use liquid or aerosol cleaners, which may contain flammable substances.



WARNING

Be sure to **turn off** the main power supply when you are installing or removing the controller. **Failure to heed this warning may lead to electric shock.**



Be sure to follow the operating requirements (regarding temperature, humidity, voltage, vibration, shock, mounting direction etc.) as stated in the specifications of the controller.



Make sure that wire scraps, chips or water do not enter inside the case of the controller. **Failure to heed this caution may lead to fire or malfunction.**



Do not block the ventilation openings. **Failure to heed this caution may lead to fire or malfunction.**

2.3 Panel cutout dimension

Use 2mm thick steel panels in setting up the IPC5000.

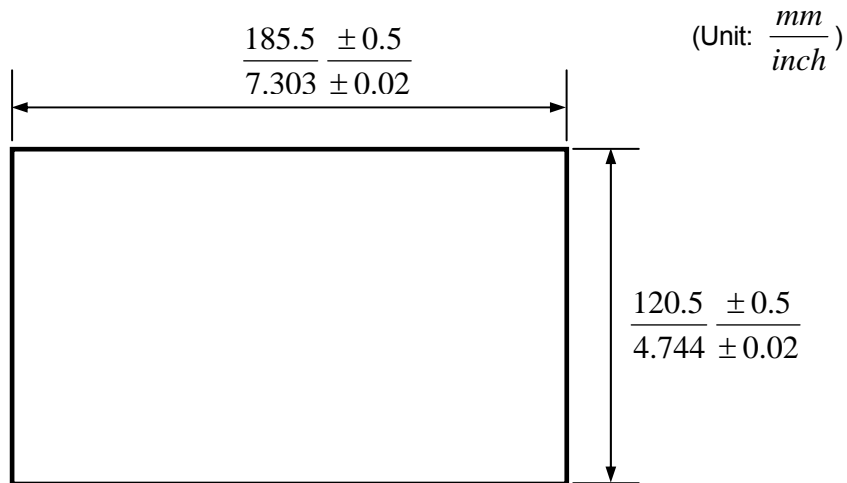
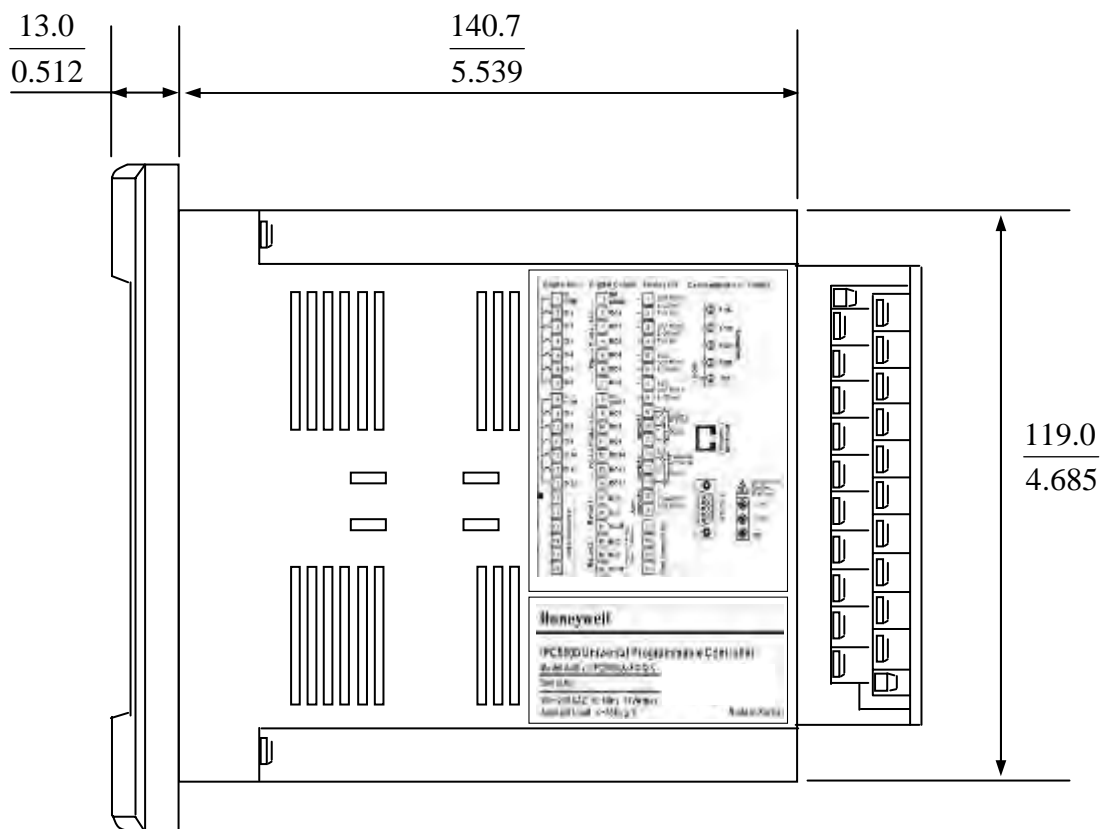
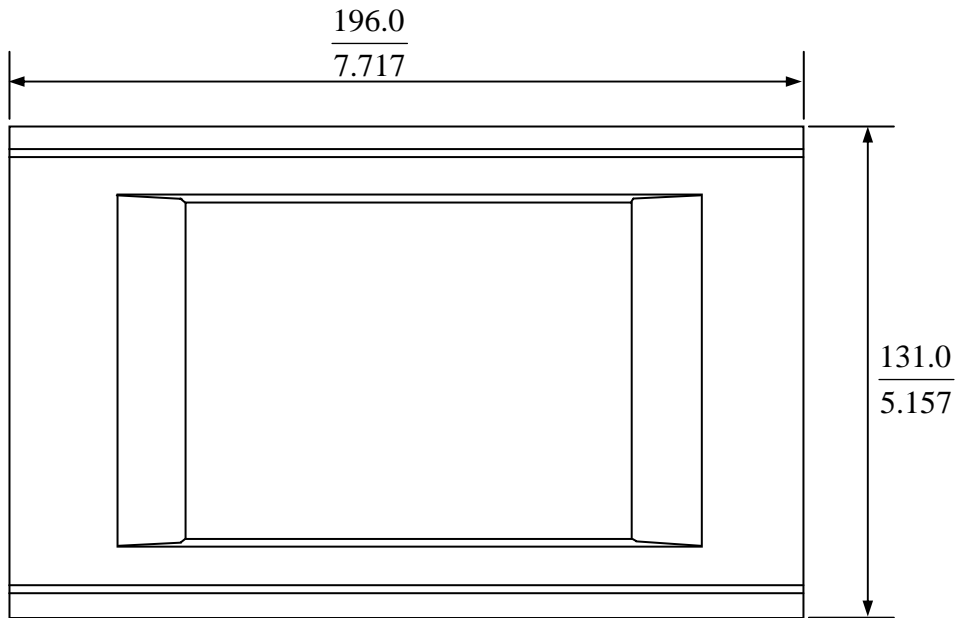

Fig. 2.3.1 Panel cutout



Install the **IPC5000** in a location where the lower panel is not exposed to temperatures that exceed the operating temperature range (0 to 50 °C).
Make sure that the temperatures above and below the controller meet specified requirements.

- Dimensions (Unit: $\frac{mm}{inch}$)



2.4 Installation of fixed brackets

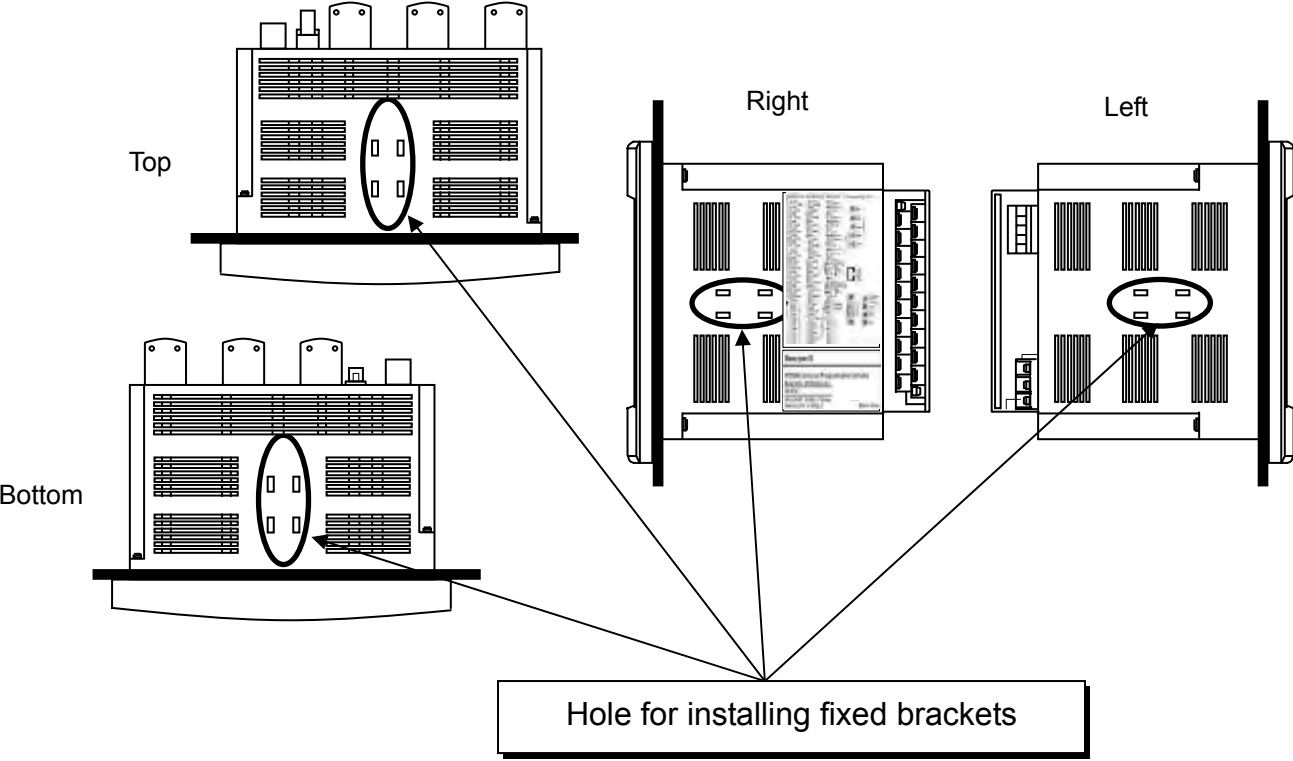

Fig. 2.4.1 Installation of fixed brackets

Mounting Method

Before mounting the controller, refer to the nameplate on the inside of the case and make a note of the model number. It will help later when selecting the proper wiring configuration.

Remove the mounting kit from the shipping container, and install the kit as follows:

- Insert the prongs of the fixed bracket into the holes
- Tighten the screw to secure the case against the panel

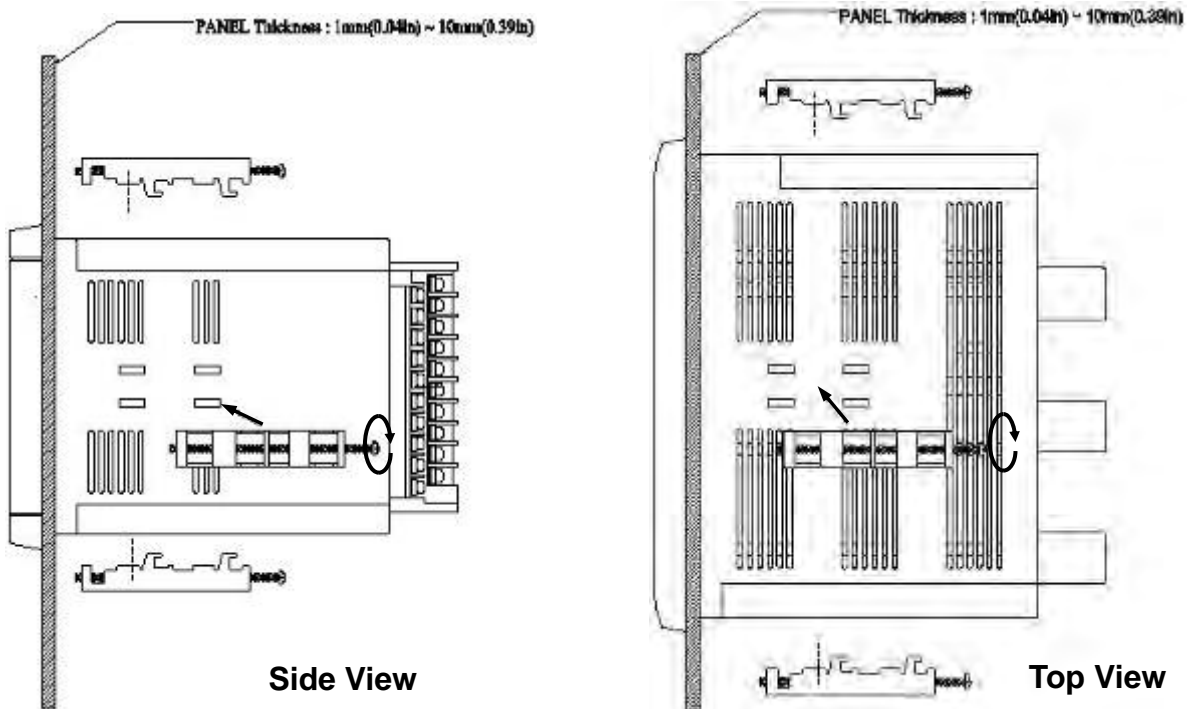

WARNING

Make sure that the main power is **switched off** before mounting IPC5000. Otherwise, there is a risk of electrical shock.



You may install the **two brackets** to the right or to the left, or at the top and the bottom.

* The case must be installed with 4 fixed brackets in case IP65 level is required for the front protection. (Two for the top and bottom, and two for both right and left sides)



Torque for clamping screws is **3~5 kg-cm (28 ~ 49 N-cm, 42~ 70 oz-in)**

2.5 Making Terminal Connections

To connect a line to the terminals (Power or Signals), use crimp-style solderless wire connectors that fit an M3.5 screw.

- Wire No. : #14 AWG (2.1 mm²)

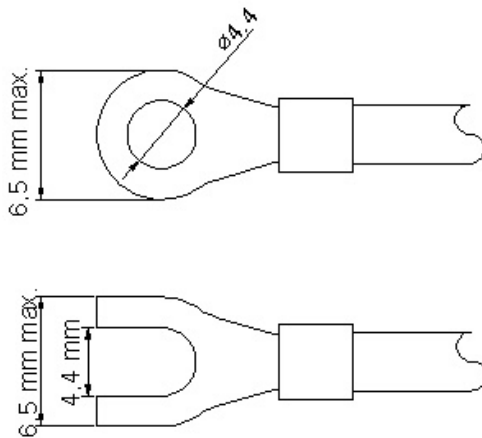

Fig. 2.5.1 Terminal with tube



If the IPC5000 is mounted in a location subject to noticeable vibration or impact, be sure to use round crimp-style solderless wire connectors to prevent lines from becoming disconnected from the terminals.



Be careful not to allow any of the crimp-style solderless wire connectors to touch adjacent terminals or connectors.



The terminal screws shall be tightened to **12 lb-in (5 kg-cm, 49 N-cm)** torque.

2.6 Terminal Array

Wires are connected to the terminal base according to the layout, shown at left in Fig 2.5.2

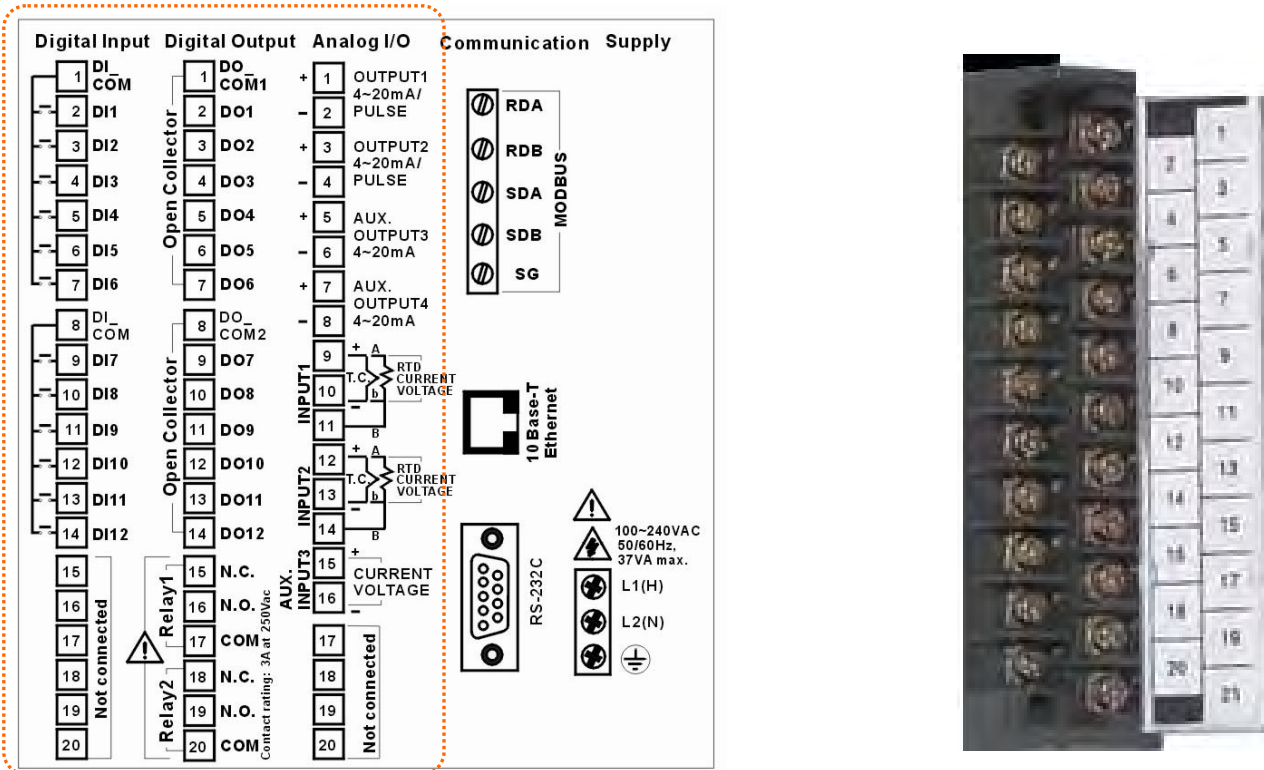

Fig. 2.5.2 Terminal diagram label and Terminal Block style

Terminal Block Style

The terminal block is available in the barrier style, shown at right in Fig.2.5.2.

- Screw : M3.0
- Wire No. : #22 to 16AWG

Wiring Rules and Recommendations

In general, stranded copper wire should be used for non-thermocouple electrical connections. Twisted-pair wiring with shielded cable will improve noise immunity if wire routing is suspect.

Wire Gage

The recommended minimum wire size for connections is as follows.

Wire Gauge	Wire Application
20	DC current and voltage field wiring
22	DC current and voltage wiring in control room

2.7 Wiring

Line voltage wiring

The controller is considered “rack and panel mounted equipment” per EN61010-1, Safety Requirements for Electrical Equipment for Measurement, Control, and Laboratory Use, Part 1: General Requirements. Conformity with 72/23/EEC, the Low Voltage Directive requires the user to provide adequate protection against a shock hazard, the user shall install this controller in an enclosure that limits OPERATOR access to the rear terminals.

Controller Grounding

PROTECTIVE BONDING (grounding) of this controller and the enclosure in which it is installed shall be in accordance with National and local electrical codes. To minimize electrical noise and transients that may adversely affect the system, supplementary bonding of the controller enclosure to a local ground, using a No.12(4 mm²) copper conductor, is recommended.

Control/Alarm Circuit Wiring

The insulation of wires connected to the Control/Alarm terminals shall be rated for the highest voltage involved. Extra Low Voltage (ELV) wiring (input, current output, and low voltage Control/Alarm circuits) shall be separated from HAZARDOUS LIVE (>30 Vac, 42.4 Vpeak, or 60 Vdc) wiring.

Terminal Block Style

The terminal block is available in the barrier style, shown in Fig.2.6.1.

- Screw : M3.5
- Wire No. : #16 to 14AWG

Wiring Rules and Recommendations

In general, stranded copper wire should be used for non-thermocouple electrical connections. Twisted-pair wiring with shielded cable will improve noise immunity if wire routing is suspect.

Wire Gage

Observe all local codes when making power connections. Unless local electrical codes dictate other wire, the recommended minimum wire size for connections is given in Table 2.7.1.

Table 2.7.1 Minimum Recommended Wire Sizes

Wire Gauge	Wire Application
14 to 16	AC to power supply
10 to 14	Earth ground wire

Wiring Diagrams

1) Connection of power supply input terminal

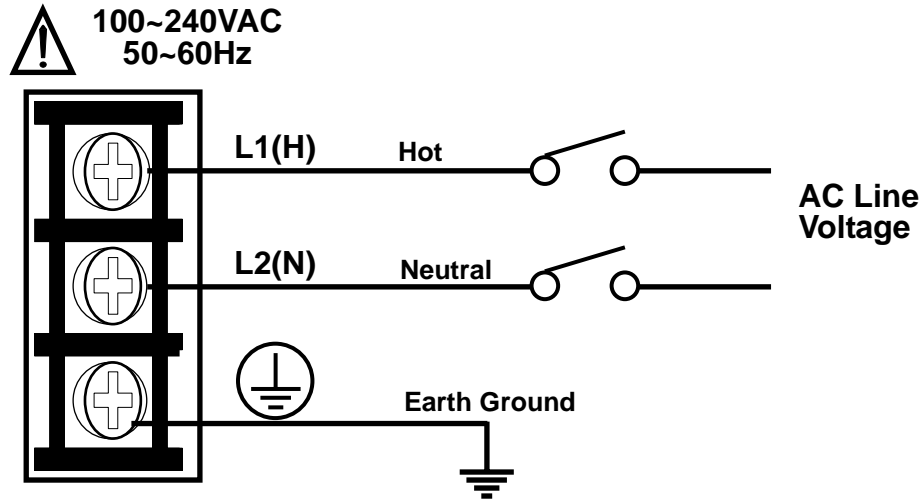

Fig. 2.7.1 Mains Power Supply



PROTECTIVE BONDING (grounding) of this controller and the enclosure in which it is installed shall be in accordance with National and local electrical codes. To minimize electrical noise and transients that may adversely affect the system, supplementary bonding of the controller enclosure to a local ground, using a No.12(4 mm²) copper conductor, is recommended.



CAUTION

To prevent product damage and failure, **do not connect power supply cable to PE terminal.**



WARNING

Make sure that wiring to the main power supply is disconnected from the site AC source before installing wiring.

2) Connection of **Analog input** terminal

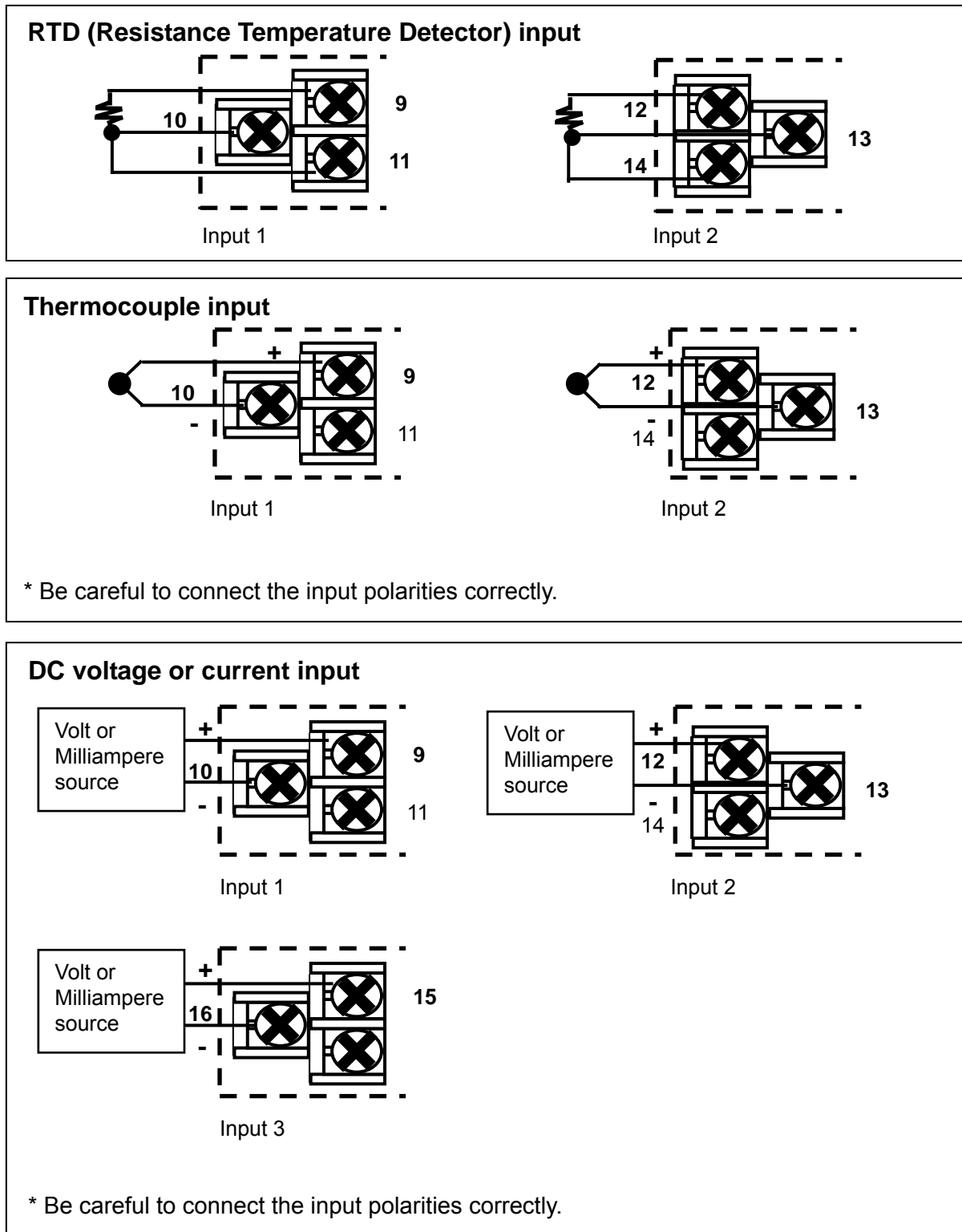

Fig. 2.7.2 Analog input 1 / input 2 Connections

For INPUT2 and INPUT3, these are NOT available for IPC5000S.

3) Connection of Universal control output

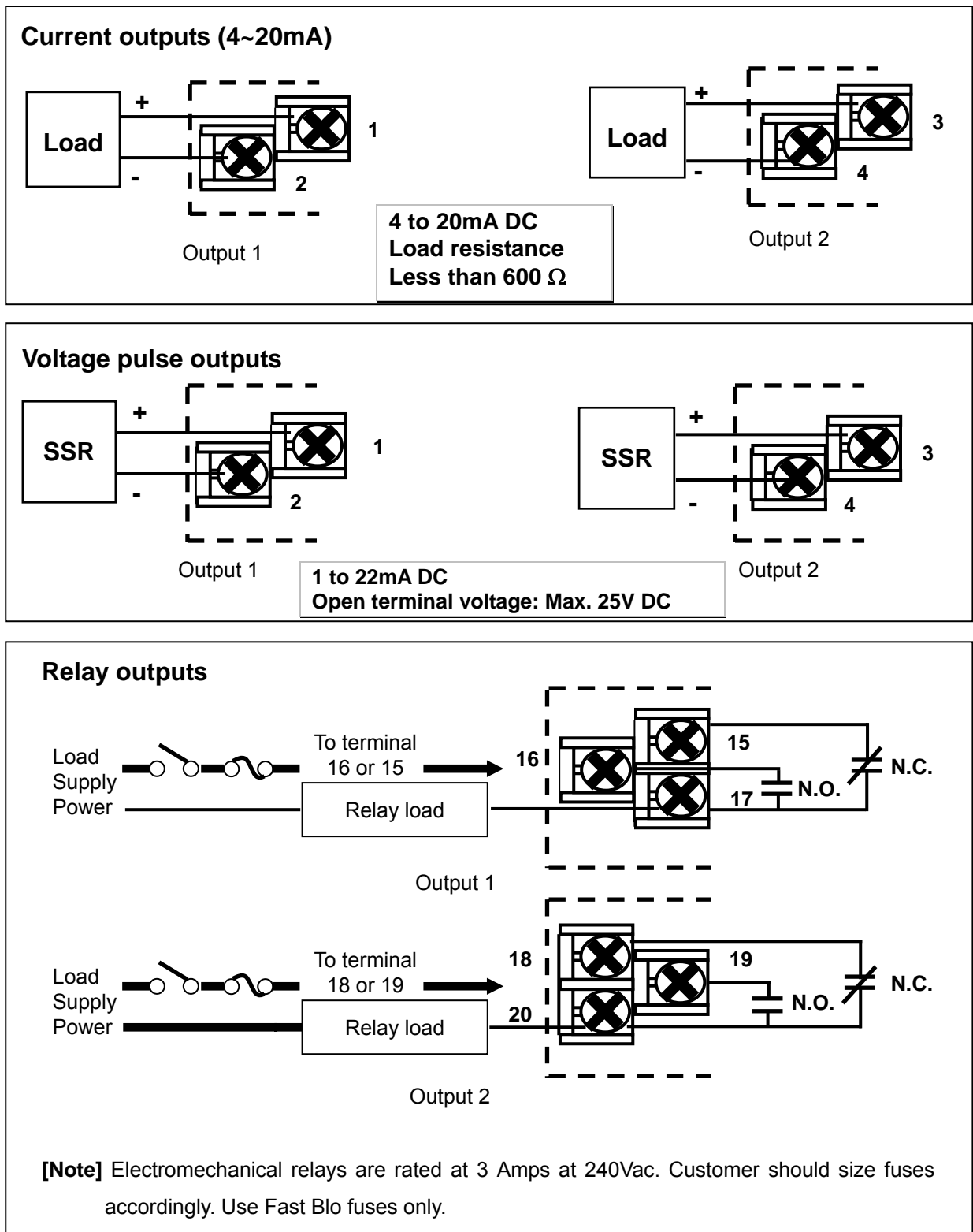

Fig. 2.7.3 Control output 1 / output 2 Connections

The 'Voltage pulse output' is not available for IPC5000S.

4) Connection of Digital outputs

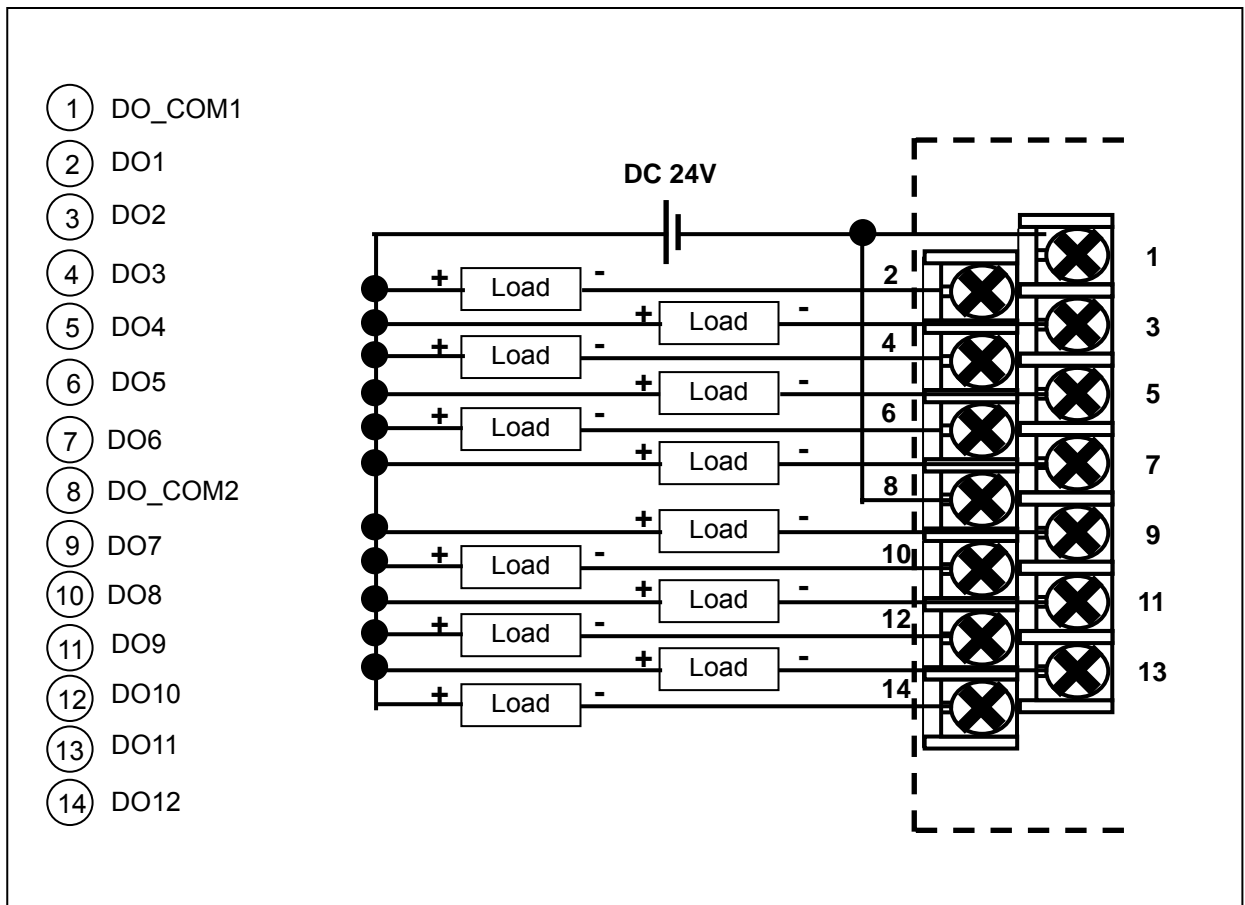

Fig. 2.7.4 Digital outputs Connection



CAUTION

Open-collector output of IPC5000 is designed for **30VDC** and less than **100mA**. When using a relay as a load, use a relay for 24VDC. 24 volt power supply needs **supplied by user**. Supply should have a **minimum current rating of 1.5A**.

5) Connection of **Digital input**

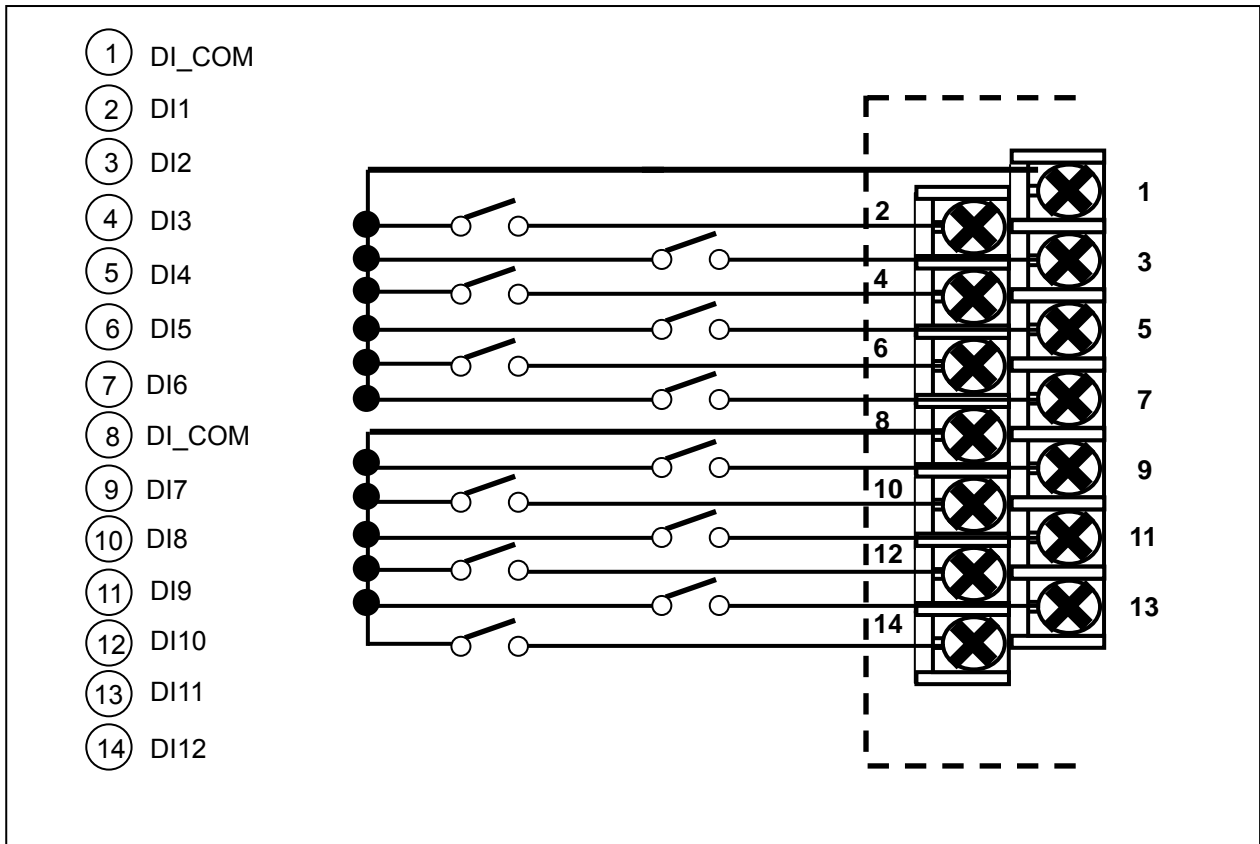

Fig. 2.7.5 Digital inputs Connections

6) Connection of **Auxiliary output** (Option) – IPC5000D

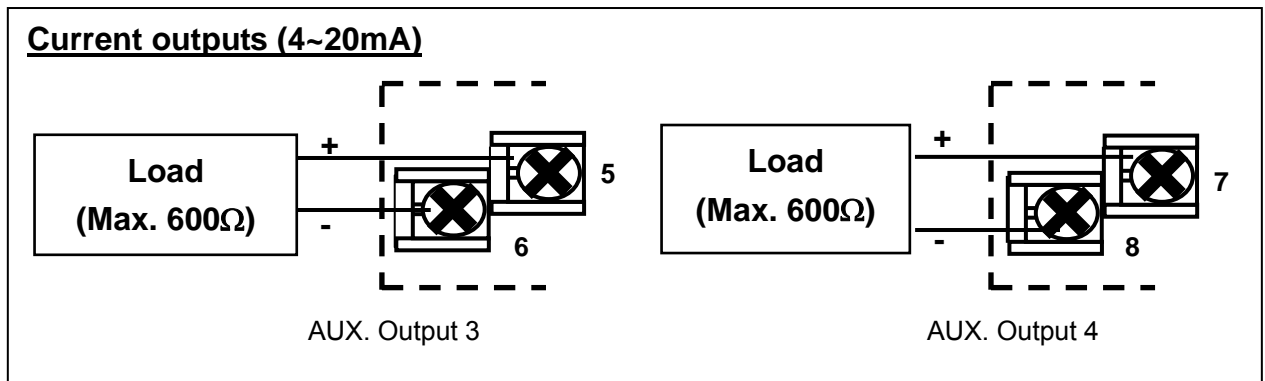

Fig. 2.7.6 Auxiliary output 3 output 4 Connections

For Auxiliary output 3 and 4, these are NOT available for IPC5000S.

7) Connection of **RS-232C** communication

- **9 pin to 9 pin**

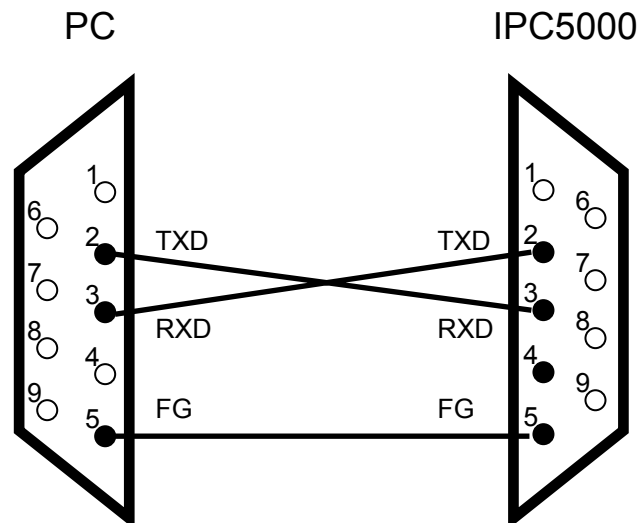

Fig. 2.7.7 RS-232C communication 9 pin Connection

In this 3-wire cable, **pin 2 and 3** should **be crossed** and pin 5 should be directly wired. The length of the communication line between PC and IPC5000 should be 15m (49.2 ft.) or less.

- 25 pin to 9 pin

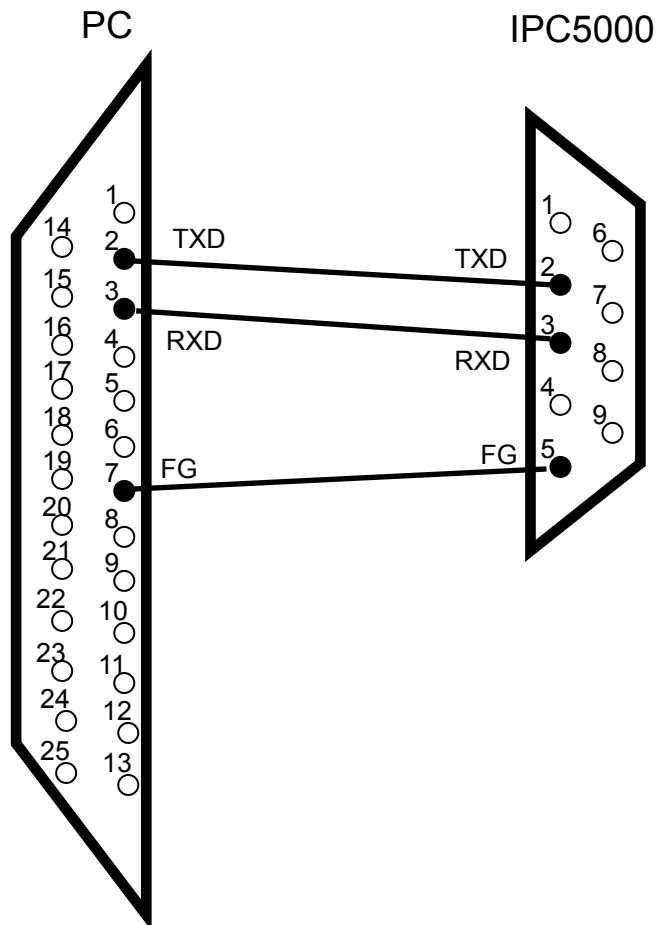

Fig. 2.7.8 RS-232C communication 25 to 9 pin Connection

In this 3-wire cable **pin 2 and 3** should **be connected directly** and pin 5 should be directly wired to pin 7. The length of the communication line between PC and IPC5000 should be 15m (49.2 ft.) or less.

8) Connection of **ModBus**

The IPC5000 with the optional communication provides an RS 485 communications ports with ModBus RTU protocol support.

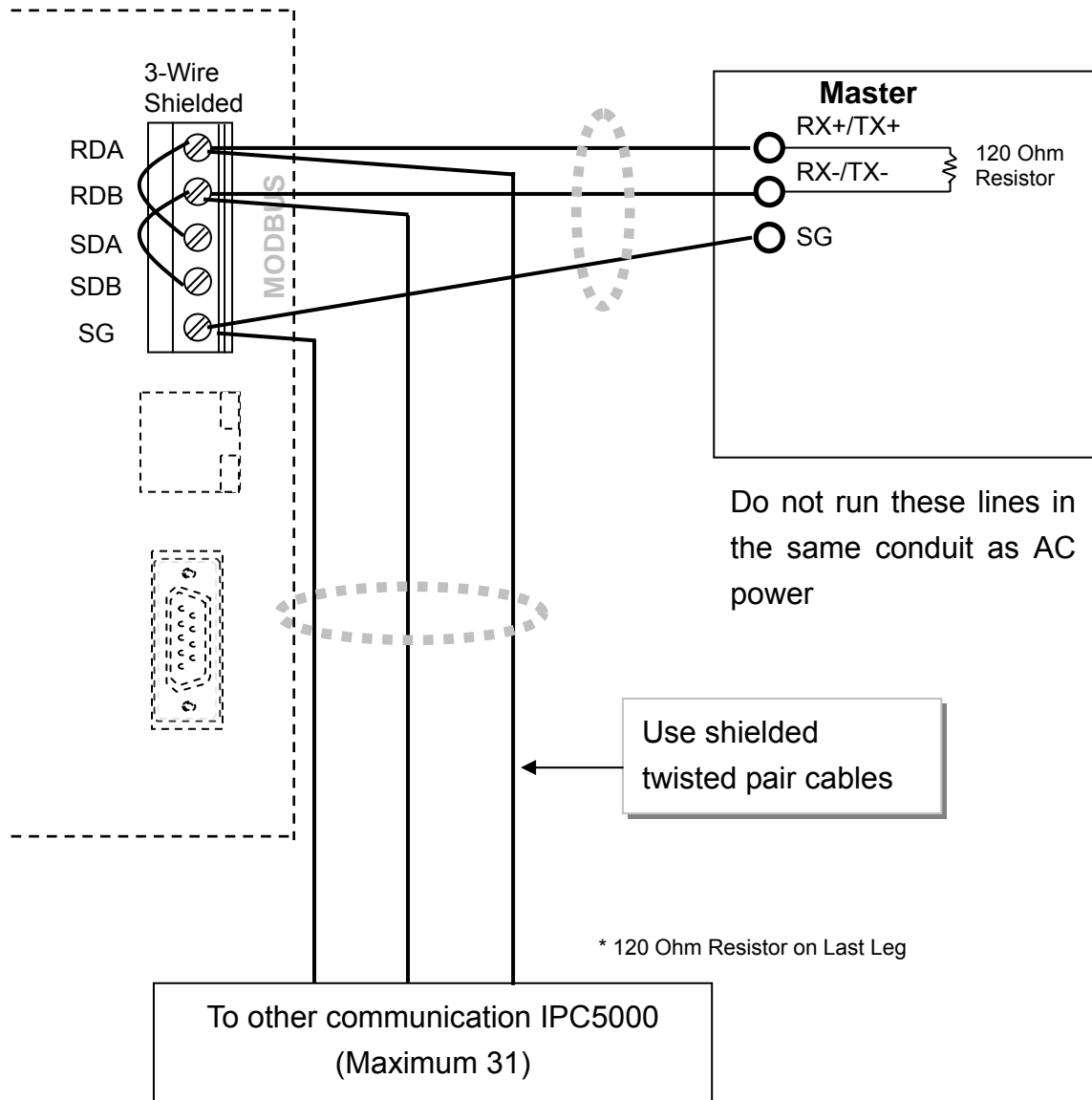

Fig. 2.7.9 RS422/485/Modbus Communications Option Connections (3-Wire shield)

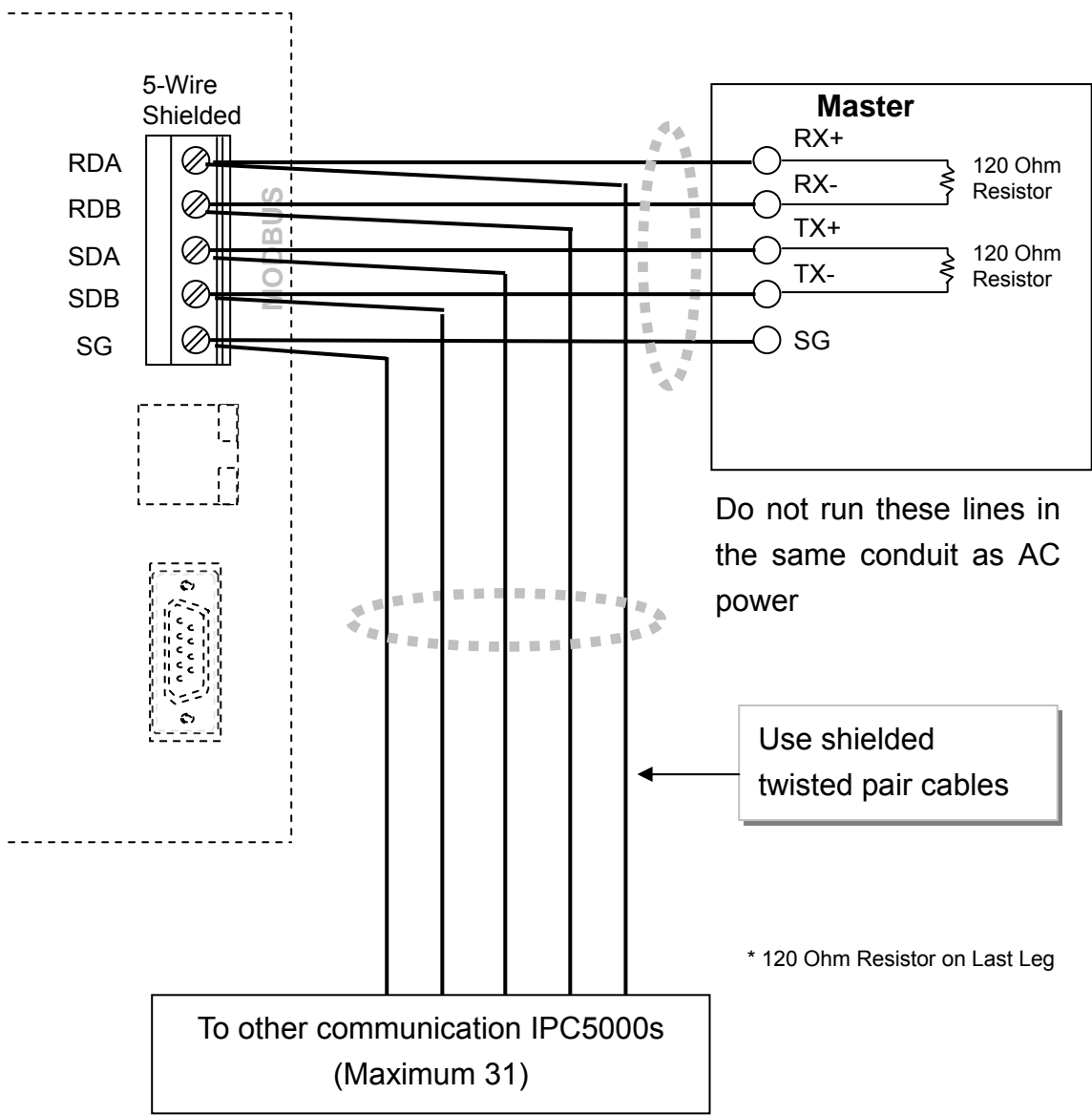

Fig. 2.7.10 RS422/485/Modbus Communications Option Connections (5-Wire shield)

9) Connection of **Ethernet** (Option)

IPC5000 is available for data monitoring or operating on touch operation panel as HMI or PC software by 1:1 or 1:N through Ethernet port, Protocol should be used Modbus TCP only.

Setup of **Ethernet port**

The setup of Ethernet port can be set on '3.20 NETWORK SET' screen, the setting parameters are as following table.

Parameter for setup of Ethernet port

Setting parameter	Range	Remark
Protocol	Modbus TCP : Fixed	
FP Type	FPB, FPLB, FPBB, FPL	It is available for Universal Modbus only.
IP Address	-	Default=192.168.0.2
GATE way	-	Default =192.168.0.2
Sub net	-	Default =255.255.255.0

Wiring

For Ethernet Communication, it should be used as followings.

Direct cable(PC to HUB)



	Output	Input	Remark
Transmitt(TX)	Cable 1,2	Cable 1,2	
Receiving(RX)	Cable 3,6	Cable 3,6	

Crossover cable

- In case of connection PC into IPC5000.



	Output	Input	Remark
Transmitt(TX)	Cable 1,2	Cable 3,6	Output
Receiving(RX)	Cable 3,6	Cable 1,2	Input

Table 2.7.2 Instrument input range code and range

Input type		Input range code	Instrument input range		Measurement accuracy: ± 0.1% of span typical(± 1 digit for display)	
			°C	°F		
DC Voltage	0~10V	DCV1	Programmable range -19999 ~ 20000 (Decimal point position is variable)		+/-0.1%FS	
	0~5V	DCV2			+/-0.1%FS	
	1~5V	DCV3			+/-0.1%FS	
DC Current	0~20mA	MA1	Programmable range -19999 ~ 20000 (Decimal point position is variable)		+/-0.1%FS	
	4~20mA	MA2			+/-0.1%FS	
RTD	Pt100 (JIS/IEC)	Pt1	-200.0~500.0	-328.0~932.0	+/-0.1%FS	
		Pt2	-200.0~200.0	-328.0~392.0	+/-0.1%FS	
		Pt3	-100.0~150.0	-148.0~302.0	+/-0.1%FS	
		Pt4	-50.0~200.0	-58.0~392.0	+/-0.1%FS	
		Pt5	-40.0~60.0	-40.0~140.0	+/-0.2%FS	
		Pt6	0.0~100.0	32.0~212.0	+/-0.2%FS	
		Pt7	0.0~300.0	32.0~572.0	+/-0.1%FS	
		Pt8	0.0~500.0	32.0~932.0	+/-0.1%FS	
RTD	JPt100 (JIS)	JPt1	-200.0~500.0	-328.0~932.0	+/-0.1%FS	
		JPt2	-200.0~200.0	-328.0~392.0	+/-0.1%FS	
		JPt3	-100.0~150.0	-148.0~302.0	+/-0.1%FS	
		JPt4	-50.0~200.0	-58.0~392.0	+/-0.1%FS	
		JPt5	-40.0~60.0	-40.0~140.0	+/-0.2%FS	
		JPt6	0.0~100.0	32.0~212.0	+/-0.2%FS	
		JPt7	0.0~300.0	32.0~572.0	+/-0.1%FS	
		JPt8	0.0~500.0	32.0~932.0	+/-0.1%FS	

* FS : Full Scale

NEXT

Continued

Input type		Input range code	Instrument input range		Measurement accuracy: ± 0.1% of span typical(± 1 digit for display)	
			°C	°F		
Thermo couple	K(CA)	K1	-200.0~200.0	-328.0~392.0	+/-0.1%FS	Below 0°C : +/-0.2%FS
		K2	0.0 ~ 1200.0	32.0~2192.0	+/-0.1%FS	
		K3	0.0~800.0	32.0~1472.0	+/-0.1%FS	
		K4	0.0~400.0	32.0~752.0	+/-0.1%FS	
		K5	0.0~1316.0	32.0~2400.0	+/-0.1%FS	
	J(IC)	J	0.0~800.0	32.0~1472.0	+/-0.1%FS	
	R	R	0.0~1600.0	32.0~2912.0	+/-0.1%FS	
	S	S	0.0~1600.0	32.0~2912.0	+/-0.1%FS	
	B	B	0.0~1800.0	32.0~3272.0	+/-0.1%FS	+/-4.0%FS at 0 to 260°C +/-0.15%FS at 260 to 800°C
	E(CRC)	E	0.0~800.0	32.0~1472.0	+/-0.1%FS	
	T(CC)	T	-200.0~300.0	-328~572.0	+/-0.1%FS	+/-0.3%FS at -200 to -45°C
	N	N	0.0~1300.0	32~2372	+/-0.1%FS	
	W1	W1	0.0~1200.0	32~2192	+/-0.1%FS	
	W2	W2	0.0~2300.0	32~4172	+/-0.1%FS	
C	C	0.0~2300.0	32~4172	+/-0.1%FS		

* FS : Full Scale

Table 2.7.3 The function table of External switch input (Digital input)

External switch number	Function		Detection way
	IPC5000D	IPC5000S	
SW1	RUN/STOP (RUN<-> STOP)		Leading edge
SW2	HOLD		ON status
SW3	ADV		Leading edge
SW4	Trouble input 1		
SW5	Trouble input 2		
SW6	Channel selection ^[NOTE 1]	Trouble input 3	ON status
SW7		Trouble input 4	ON status
SW8	Pattern selection ^[NOTE 2]		
SW9			
SW10			
SW11			
SW12			

[NOTE 1] Channel selection

SW6	SW7	Description	Remark
ON	ON	Enabled both channel (CH1,CH2)	These are available IPC5000D
ON	OFF	Enabled CH1, but disabled CH2	
OFF	ON	Enabled CH2, but disabled CH1	
OFF	OFF	Disabled both channel (CH1,CH2)	

[NOTE 2] Pattern selection

Pattern No.	SW8	SW9	SW10	SW11	SW12	Detection way
0	OFF	OFF	OFF	OFF	OFF	
1	OFF	OFF	OFF	OFF	ON	
2	OFF	OFF	OFF	ON	OFF	
3	OFF	OFF	OFF	ON	ON	
4	OFF	OFF	ON	OFF	OFF	
5	OFF	OFF	ON	OFF	ON	
6	OFF	OFF	ON	ON	OFF	
7	OFF	OFF	ON	ON	ON	
8	OFF	ON	OFF	OFF	OFF	
9	OFF	ON	OFF	OFF	ON	
10	OFF	ON	OFF	ON	OFF	
11	OFF	ON	OFF	ON	ON	
12	OFF	ON	ON	OFF	OFF	
13	OFF	ON	ON	OFF	ON	
14	OFF	ON	ON	ON	OFF	
15	OFF	ON	ON	ON	ON	
16	ON	OFF	OFF	OFF	OFF	
17	ON	OFF	OFF	OFF	ON	
18	ON	OFF	OFF	ON	OFF	
19	ON	OFF	OFF	ON	ON	
20	ON	OFF	ON	OFF	OFF	
21	ON	OFF	ON	OFF	ON	
22	ON	OFF	ON	ON	OFF	
23	ON	OFF	ON	ON	ON	
24	ON	ON	OFF	OFF	OFF	
25	ON	ON	OFF	OFF	ON	
26	ON	ON	OFF	ON	OFF	
27	ON	ON	OFF	ON	ON	
28	ON	ON	ON	OFF	OFF	
29	ON	ON	ON	OFF	ON	
30	ON	ON	ON	ON	OFF	
31	ON	ON	ON	ON	ON	

2.8 Terminal Allocation

No.	Terminal name	Function
1	DI_COM	
2	DI1	Digital input1
3	DI2	Digital input2
4	DI3	Digital input3
5	DI4	Digital input4
6	DI5	Digital input5
7	DI6	Digital input6
8	DI_COM	
9	DI7	Digital input7
10	DI8	Digital input8
11	DI9	Digital input9
12	DI10	Digital input10
13	DI11	Digital input11
14	DI12	Digital input12
15	Not Connected	
16		
17		
18		
19		
20		

No.	Terminal name	Function
1	DO_COM1	
2	DO1	Digital output1
3	DO2	Digital output2
4	DO3	Digital output3
5	DO4	Digital output4
6	DO5	Digital output5
7	DO6	Digital output6
8	DO_COM2	
9	DO7	Digital output7
10	DO8	Digital output8
11	DO9	Digital output9
12	DO10	Digital output10
13	DO11	Digital output11
14	DO12	Digital output12
15	N.C.	Relay 1
16	N.O.	
17	COM	
18	N.C.	Relay 2
19	N.O.	
20	COM	

[Note] Open collector outputs are externally powered.
Two common terminals are disconnected each other. And in case of need, connect two common terminal (DO_COM1 and DO_COM2) by a wire.

No.	Terminal name	Function
1	Output1(+)	4~20mA,
2	Output1(-)	Voltage Pulse
3	Output2(+)	4~20mA,
4	Output2(-)	Voltage Pulse
5	Output3(+)	AUX Output
6	Output3(-)	(4~20mA)
7	Output4(+)	AUX Output
8	Output4(-)	(4~20mA)
9	Input1 (+)	RTD(A),mA,V,TC
10	Input1 (-)	RTD(b)
11	Input1(B)	RTD(B)
12	Input2 (+)	RTD(A),mA,V,TC
13	Input2 (-)	RTD(B)
14	Input2(B)	RTD(B)
15	Input3(+)	AUX Input(mA,V)
16	Input3(-)	
17	Not Connected	
18		
19		
20		

No.	Terminal name	Function
9 pin	D-sub connector (9 pin)	RS232 (default)
8 pin	RJ-45 connector (8 pin)	Ethemet (option)
5 pin	RDA	RS485 Modbus (option)
	RDB	
	SDA	
	SDB	
	SG	

Terminal name	Function
L	100Vac to Main
N	240Vac Power supply
	Protective Earth Connect the PE to Chassis ground

[IPC5000D type]

No.	Terminal name	Function
1	Output1(+)	4~20mA,
2	Output1(-)	Voltage Pulse
3	Output2(+)	4~20mA,
4	Output2(-)	Voltage Pulse
5	Not Connected	
6		
7		
8		
9	Input1 (+)	RTD(A),mA,V,TC
10	Input1 (-)	RTD(b)
11	Input1(B)	RTD(B)
12	Not Connected	
13		
14		
15		
16		
17		
18		
19		
20		

No.	Terminal name	Function
9 pin	D-sub connector (9 pin)	RS232 (default)
8 pin	RJ-45 connector (8 pin)	Ethemet (option)
5 pin	RDA	RS485(Modbus) (option)
	RDB	
	SDA	
	SDB	
	SG	

Terminal name	Function
L	100Vac to Main
N	240Vac Power supply
	Protective Earth (PE) Connect the PE to Frame Ground

[IPC5000S type]

2.9 Rear terminal

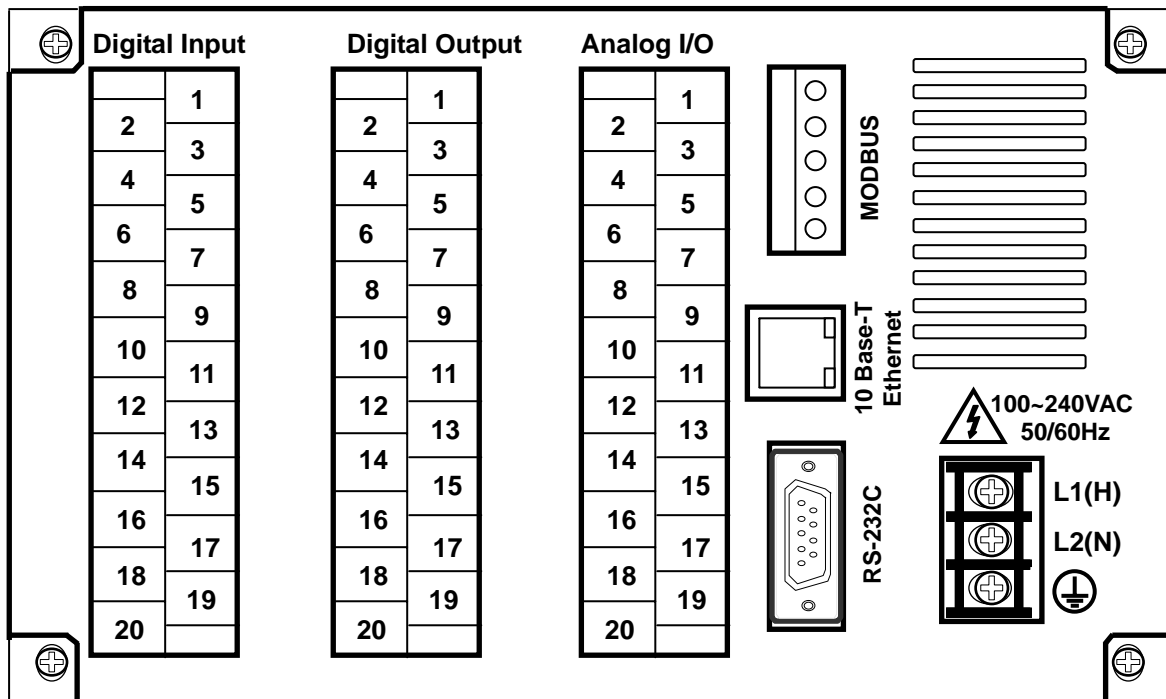

Fig. 2.9.1 Rear Terminal



1. **MODBUS** on Fig. 2.9.1 indicates the **OPTION** part. Models that do not select ModBus OPTION do not support ModBus communication.
2. **Ethernet** on Fig 2.9.1 indicates the **OPTION** part. Models that do not select Ethernet OPTION do not support Ethernet communication.

3. Configuration

This is an initial set-up that determines appropriate control performance and capacity of applied systems or devices and consists of the elements described on Fig. 3.1.1.

3.1 Screen configuration

Screen configuration consists of a screen switch selection mode (Fig. 3.1.1). To set up the initial screen configuration (Fig. 3.2.1), press the right-hand corner at the bottom of the main screen and then press the left-hand corner at the bottom of the screen (see Fig. 3.1.2).

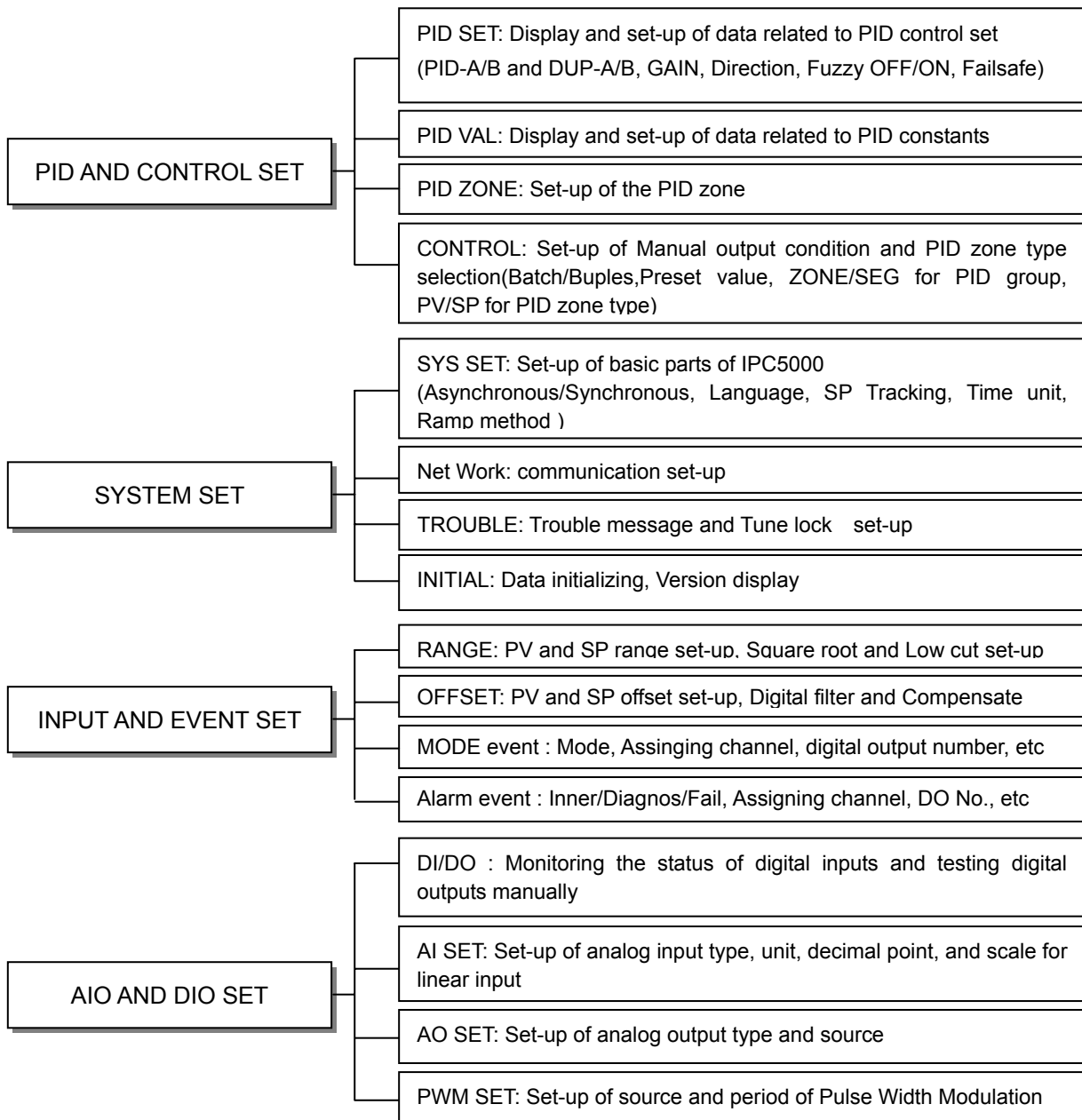

Fig. 3.1.1 Screen switch block

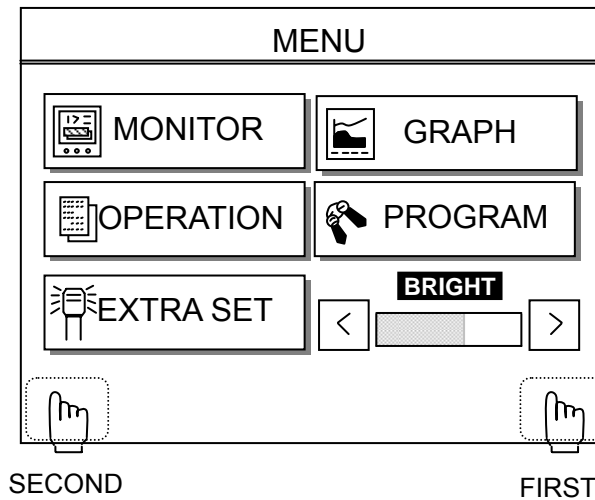

Fig. 3.1.2 Main menu screen

3.2 Configuration screen

In order to enter the screen shown on Fig. 3.2.1, press the right-hand corner at the bottom of the screen as is shown on Fig. 3.1.2 and then press the left-hand corner at the bottom within 1 second.

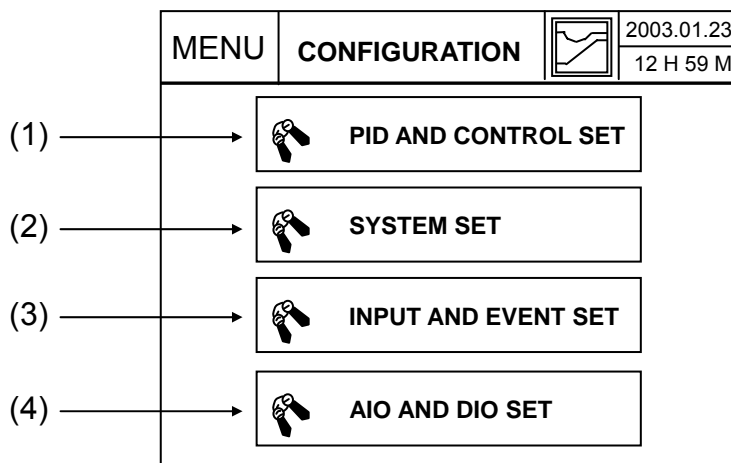

Fig. 3.2.1 SETUP (Configuration)

- (1) Button 1
 - Switch to **PID PARAMETER** and **CONTROL setup** screen
- (2) Button 2
 - Switch to **SYSTEM setup** screen
- (3) Button 3
 - Switch to **INPUT PARAMETER, EVENT setup** screen
- (4) Button 4
 - Switch to **AI/AO, Control Output** , and **DI/DO Monitor** screen

3.3 AI SET screen

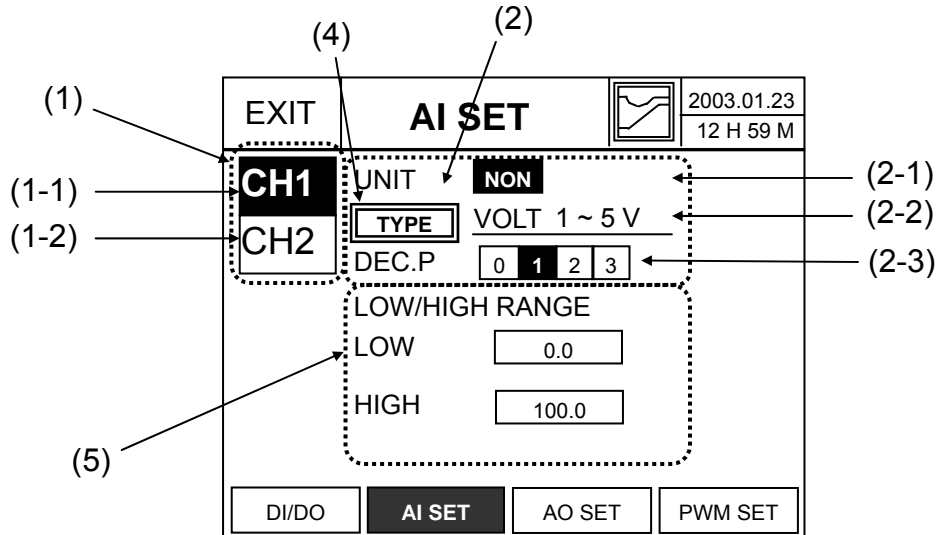

Fig. 3.3.1 AI SET Screen

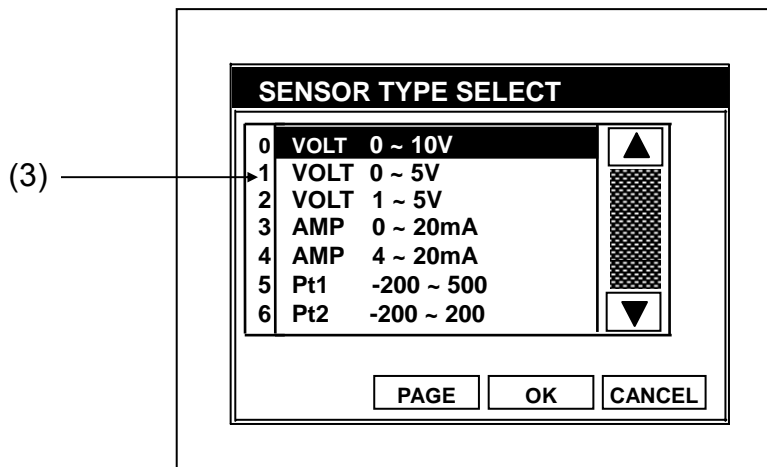

Fig. 3.3.2 SENSOR TYPE SELECTS

(1) Input Channel Setup

It is available for IPC5000D.

(1-1) CH1 Select & Setup button

- When button 'CH1' is pressed, it is **highlighted** and selected.

(1-2) CH2 Select & Setup button

- When button 'CH2' is pressed, it is highlighted and selected.

(2) Sensor Input Display Setup.

(2-1) UNIT: PV UNIT Setup

- Indicates unit by temperature input. Celsius: C / Fahrenheit: F / etc.: NONE
- If the unit is selected by Volt/Current(0~10V, 0~5V, 1~5V, 0~20mA, 4~20mA), the unit is fixed by NONE automatically.
- If the sensor type is selected by RTD or TC, the mean of the unit(NONE) is same with Celsius(C).

(2-2) TYPE: Code indicates ready-setup type of sensor. Default = VOLT 0 ~ 10V

- Sensor type & Code Table (See Chart below).

Input type		Input range code	Instrument input range	
			DEG C	DEG F
Linear	DC Voltage	DCV1	0~10V (-19999 ~ 20000)	
		DCV2	0~5V (-19999 ~ 20000)	
		DCV3	1~5V (-19999 ~ 20000)	
	DC Current	MA1	0~20mA (-19999 ~ 20000)	
		MA2	4~20mA (-19999 ~ 20000)	
RTD	Pt100 (JIS/IEC .00385)	Pt1	-200.0~500.0	-328.0~932.0
		Pt2	-200.0~200.0	-328.0~392.0
		Pt3	-100.0~150.0	-148.0~302.0
		Pt4	-50.0~200.0	-58.0~392.0
		Pt5	-40.0~60.0	-40.0~140.0
		Pt6	0.0~100.0	32.0~212.0
		Pt7	0.0~300.0	32.0~572.0
		Pt8	0.0~500.0	32.0~932.0
RTD	JPt100 (JIS)	JPt1	-200.0~500.0	-328.0~932.0
		JPt2	-200.0~200.0	-328.0~392.0
		JPt3	-100.0~150.0	-148.0~302.0
		JPt4	-50.0~200.0	-58.0~392.0
		JPt5	-40.0~60.0	-40.0~140.0
		JPt6	0.0~100.0	32.0~212.0
		JPt7	0.0~300.0	32.0~572.0
		JPt8	0.0~500.0	32.0~932.0

Input type		Input range code	Instrument input range	
			DEG C	DEG F
Thermo couple	K	K1	-200.0~200.0	-328.0~392.0
		K2	0.0 ~ 1200.0	32.0~2192.0
		K3	0.0~800.0	32.0~1472.0
		K4	0.0~400.0	32.0~752.0
		K5	0.0~1316.0	32.0~2400.0
	J(IC)	J	0.0~800.0	32.0~1472.0
	R	R	0.0~1600.0	32.0~2912.0
	S	S	0.0~1600.0	32.0~2912.0
	B	B	0.0~1800.0	32.0~3272.0
	E	E	0.0~800.0	32.0~1472.0
	T	T	-200.0~300.0	-328~572.0
	N	N	0.0~1300.0	32~2372
	W1	W1	0.0~1200.0	32~2192.0
	W2	W2	0.0~2300.0	32~4172
C	C	0.0~2300.0	32~4172	

- If the button(4) is pushed, Figure 3.3.2 appears and you can select the sensor type in the screen.
- **If the sensor type is changed, the PV and SP low/high limit range is adjusted automatically according to the range of the selected sensor type.**

(2-3) Dec. P. (decimal point) setup: Places Decimal point indication

- Decimal point of Thermocouple and RTD type is 0 ~ 2, **Default = 1**
- Volt and mA type is from 0 ~ 3, **Default = 1**
- **If the sensor type is changed, the decimal point is one.**

(3) Sensor Select.

They are listed by sensor input type and setup range.

After pushing UP and DOWN arrow buttons and selecting the sensor type, if you push the "OK" button, the sensor type is set and if you push the "CANCAL" button, it is canceled.

If you press the 'PAGE', 7 items of the sensor types are shown.

(4) SENSOR TYPE Setup Button: Screen switching

- Switch to '**SENSOR SELECT**' screen (Fig 3.3.2).

(5) SCALE LH(Low – High)

- The high and low range of the Linear input type(Volt/Current) is set.
- This set area is displayed, if the Volt/Current(0~10V, 0~5V, 1~5V, 0~20mA,

4~20mA) is selected.

- The set range is -19999 to 20000(LOW < HIGH).
- It can be changed according to decimal point and setting the scale range like the below table.

Decimal Point	Maximum and Minimum scale -19999 ~ 20000		Scale is 0 to 1000	
	Low	High	Low	High
0	-19999	20000	0	1000
1	-1999.9	2000.0	0.0	100.0
2	-199.99	200.00	0.00	10.00
3	-19.999	20.000	0.000	1.000

Analog output Assign (IPC5000D)

Here explains about the system to assign the Analog and Digital outputs to the output terminal of **IPC5000D**.

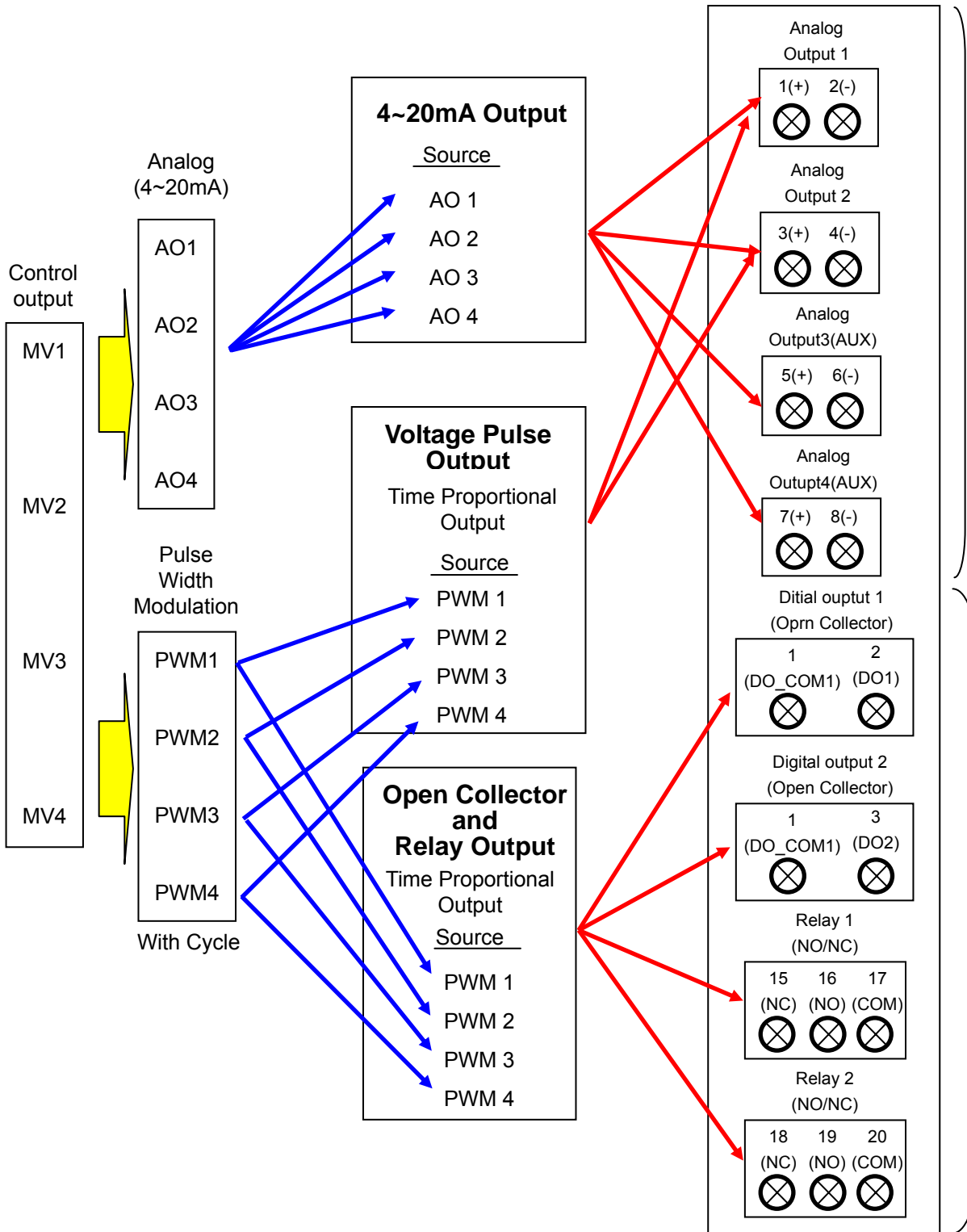

Fig. 3.4.1.a Outputs Assigning block diagram-IPC5000D

Analog output Assign (IPC5000S)

Here explains about the system to assign the Analog and Digital outputs to the output terminal of **IPC5000S**.

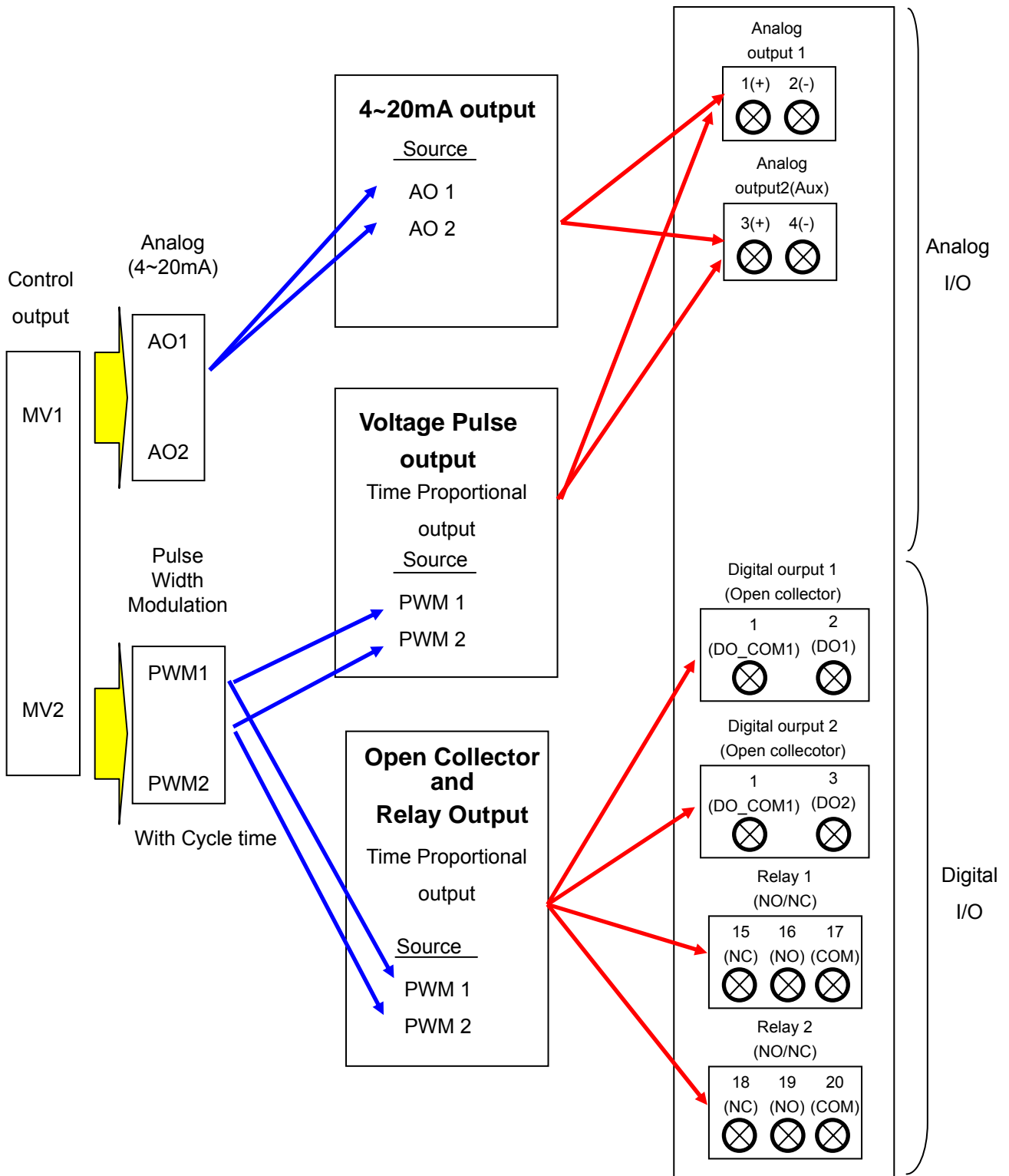
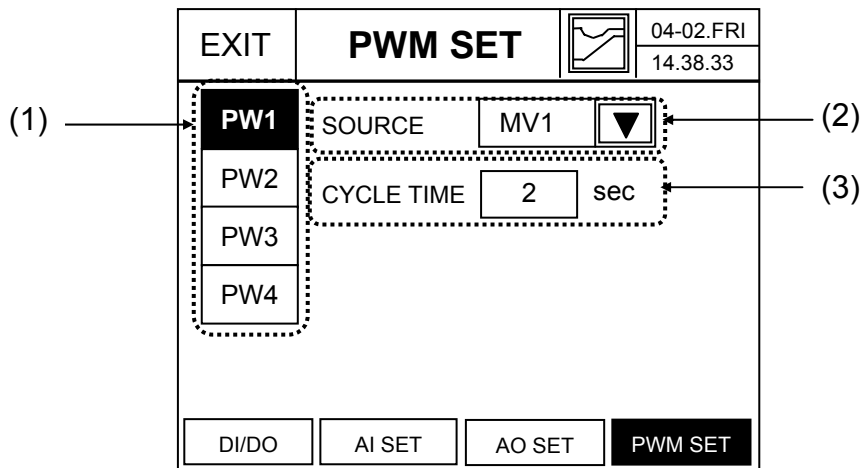

Fig. 3.4.1.b Outputs Assigning block diagram-IPC5000S

3.4 PWM set Screen

You can assign the Pulse output source of IPC5000 and set the cycle time of the pulse in this screen.

IPC5000 has four Pulse outputs(PW1,PW2,PW3,PW4) and they are used for Relay, Open Collector and Voltage Pulse output. If the MV1, MV2, MV3 and MV4 are assigned, the Pulse is operated according to the assigned MV output value. Refer to figure 3.4.1 for understanding. Assigning MVs to Pulse output is set in Figure 3.4.2.



(a) IPC5000D model

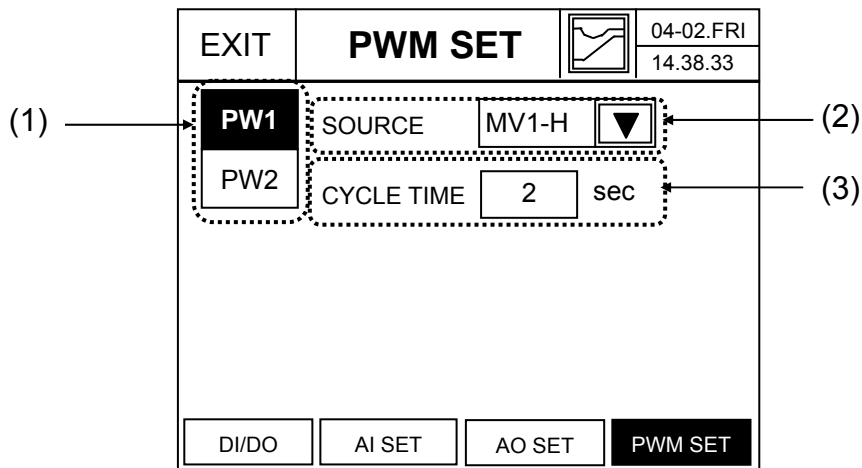

(b) IPS5000S model

Fig. 3.4.2 PWM SET screen-IPC5000S

(1) **PWM(Pulse Width Modulation) Channel Assign button** : it is **highlighted** and selected.

(2) **Source set** : It is combo box to assign the source(MV1,MV2,MV3 and MV4) for PWM.

If pushing the button(2), the combo box like figure 3.4.3 appears for the output selection and the output for assigning can be set.

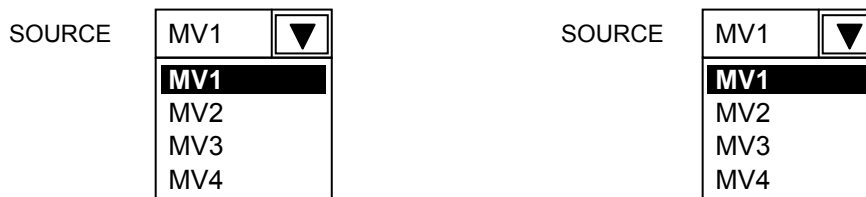

(a) IPC5000D

(b) IPC5000S

Fig. 3.4.3 MV output selection combo box

The sources for PWM of IPC5000D are MV1, MV2, MV3 and MV4 and they mean the outputs like below.

MV	Description	Addition Description
MV1	Heating control output for Loop(Channel) 1	Heating control output at Heat/Cool Heating control output at normal PID
MV2	Heating control output for Loop(Channel) 1	Heating control output at Heat/Cool Heating control output at normal PID
MV3	Cooling control output for Loop(Channel) 2	Cooling control output at Heat/Cool
MV4	Cooling control output for Loop(Channel) 2	Cooling control output at Heat/Cool

The sources for PWM of IPC5000D are MV1, MV2, MV3 and MV4 and they mean the outputs like below.

MV	Description	Addition Description
MV1	Heating control output for Loop(Channel) 1	Heating control output at Heat/Cool Heating control output at normal PID
MV2	Cooling control output for Loop(Channel) 2	Cooling control output at Heat/Cool

(3) **Cycle time set:** Sets the control cycle time for each pulse

- Set Range : 1 ~ 240 seconds
- The control cycle time set operates like fig 3.4.4.

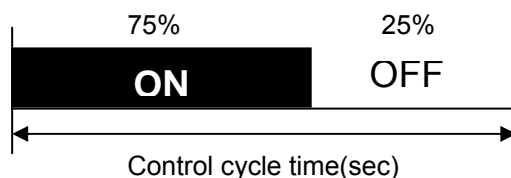

Fig 3.4.4 Pulse control output at MV = 75%

3.5 AO SET screen

This screen is for setting analog output source, output type and output scale of each channel.

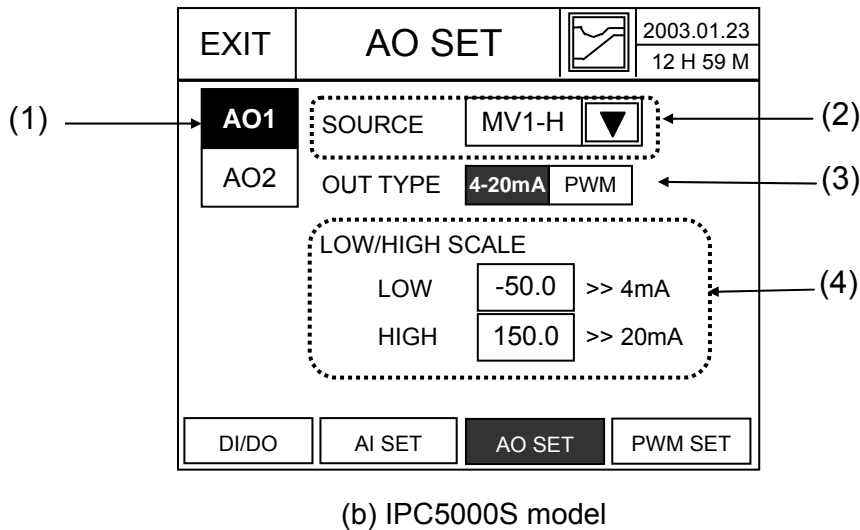
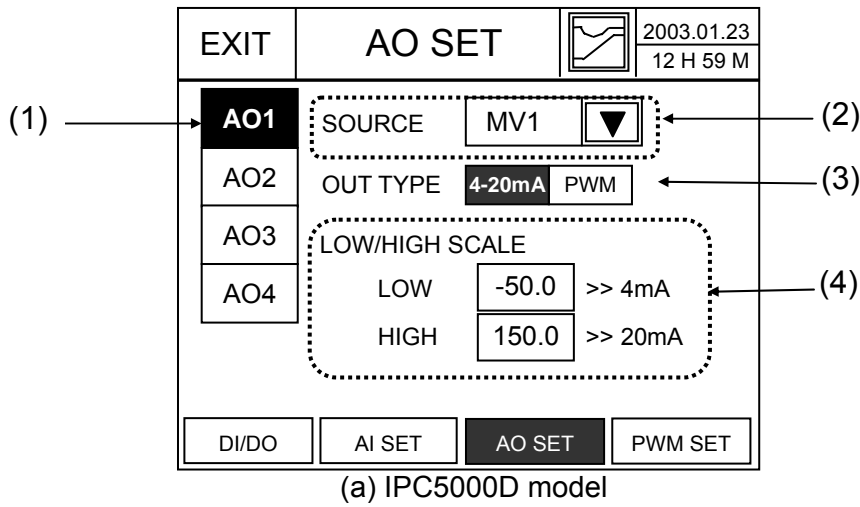

Fig. 3.5.1 AO SET screen

(1) **The selector for selecting analog output channel** : It is **highlighted** and selected.

Refer to below table for channel selection and description.

(a) IPC5000D

	Analog output	Terminal number (Analog I/O Group)	Output Type	Basic/OPT Spec.
AO1	1	1(+), 2(-)	4~20mA/ Voltage Pulse	Basic
AO2	2	3(+), 4(-)	4~20mA/ Voltage Pulse	Basic
AO3	3	5(+), 6(-)	4~20mA	OPT
AO4	4	7(+), 8(-)	4~20mA	OPT

OPT: Option

(a) IPC5000S

OPT: Option

	Analog output	Terminal number (Analog I/O Group)	Output Type	Basic/OPT Spec.
AO1	1	1(+), 2(-)	4~20mA/ Voltage Pulse	Basic
AO2	2	3(+), 4(-)	4~20mA/ Voltage Pulse	Basic

(2) **SOURCE set:** The Combo box for selecting analog output source

- If pushing this button, the items for selection like figure 3.5.2 appear in next page. If the OUT TYPE is 4~20mA, (A) appears and if it is PWM, (B) appears.
- IPC5000D : selecting one of PV1, PV2, SP1, SP2, DV1 and DV2
IPC5000S : selecting one of PV1, SP1 and DV1
When setting in figure 3.5.2, (4) item in figure 3.5.1 for setting output scale of 4~20mA is displayed.
- PWM Selection : PWM means Pulse Width Modulation and it is four pulse outputs IPC5000 supports. The MV1, MV2, MV3 and MV4 of IPC5000D and MV1 and MV2 of IPC5000S can be assigned to each pulse. Refer to figure 3.4.1 and 3.4.2 for the assigning.

(3) **OUT TYPE set :** Sets the output type to analog output terminal.

- Analog output channel 1 and 2 supports 4~20mA and Voltage pulse(PWM) and Analog output channel 3 and 4 only supports 4~20mA. Analog output channel 3 and 4 is option.

(a) IPC5000D

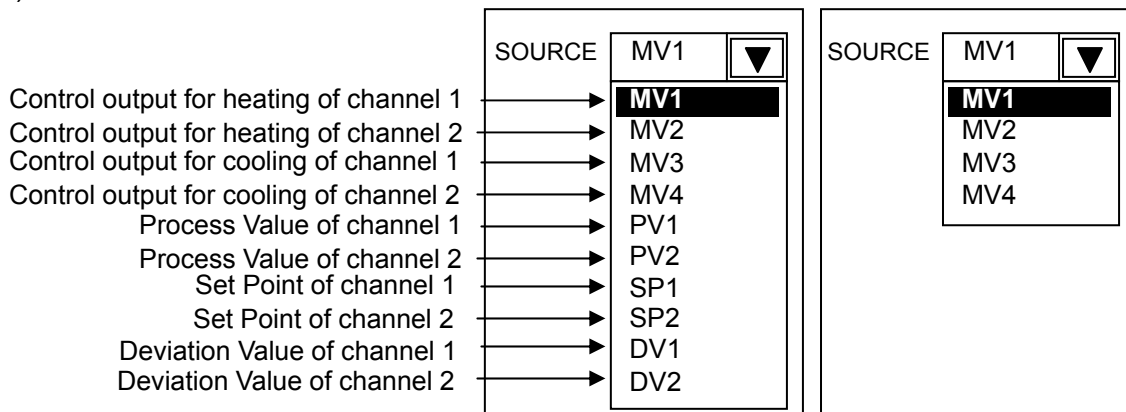

(i) OUT TYPE = 4~20mA (ii) OUT TYPE = PWM

(b) IPC5000S

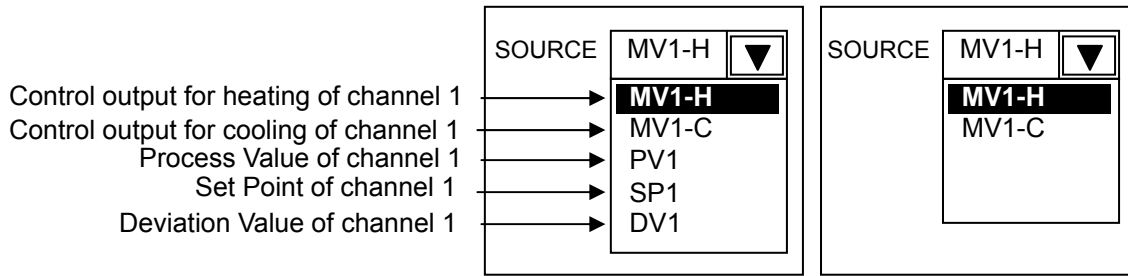

(i) OUT TYPE = 4~20mA (ii) OUT TYPE = PWM

Fig. 3.5.2 Combo box for selecting analog output source

(4) **LOW/HIGH SCALE** : Sets the analog output low/high scale for PV1, PV2, SP1, SP2, DV1 and DV2.

- This item is not displayed when the source is MV1, MV2, MV3 or MV4 of IPC5000D or output type is PWM.
- Refer to figure 3.5.3 to adjust 4~20mA by setting scale value.
 Exmample of Figure 3.5.3 is same case with set value of figure 3.5.1.

(Note) Low < High.

Refer to next page for scale graph.

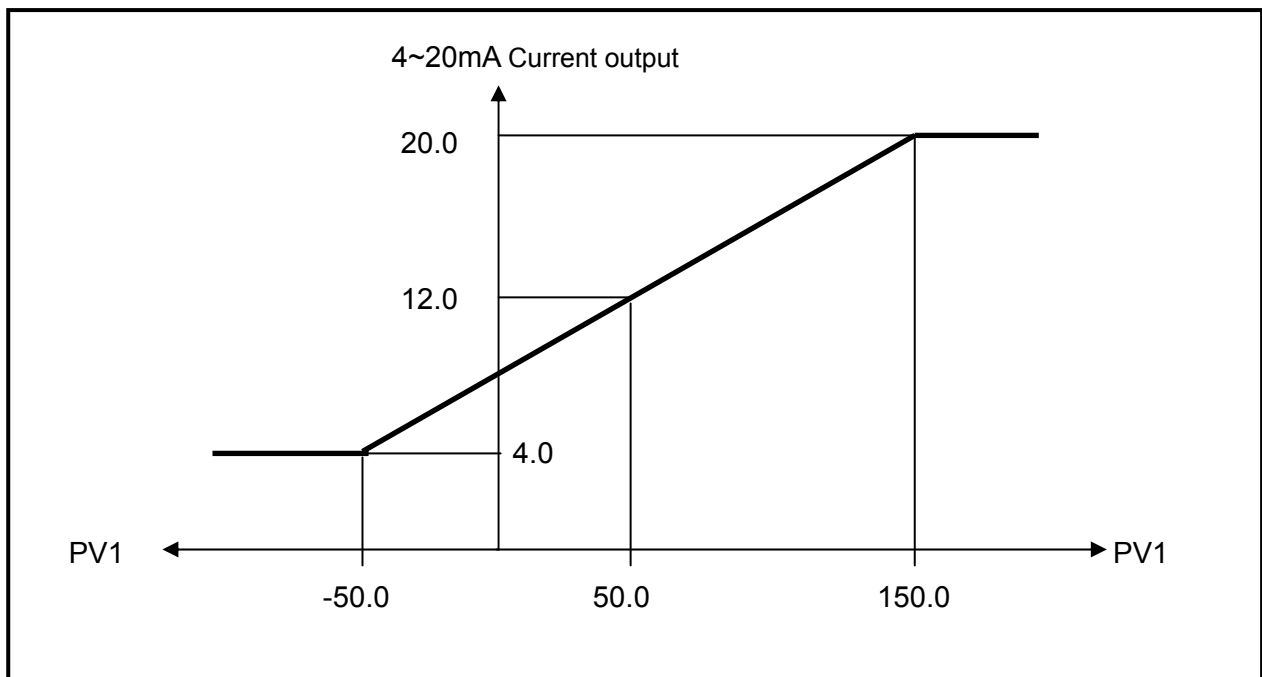
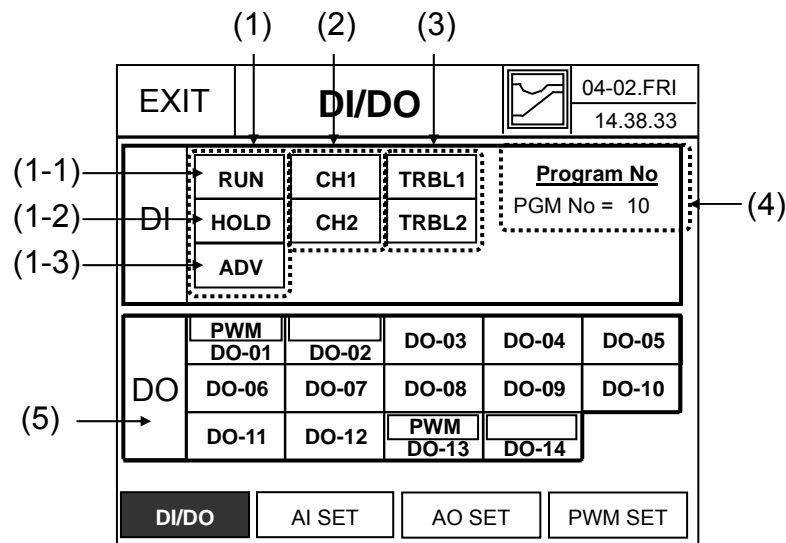

Fig. 3.5.3 Current output scale adjustable graph

3.6 DIO status screen

This display screen shows the status of external Digital input/output (Monitoring)



(a) IPC5000D

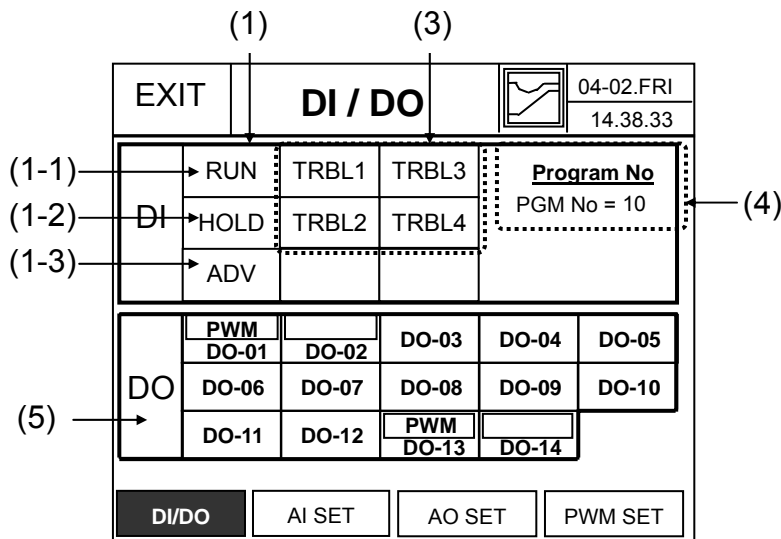

(b) IPC5000S

Fig. 3.6.1 DI/DO Screen

(1) **Status:** When highlighted it indicates that there is a remote input.

For (1-1), (1-2) and (1-3) items,

IPC5000D : These are available for depending on channel select (by DI6 and DI7).

IPC5000S : When inputting, the operation is instantly executed.

(1-1) RUN / STOP Input Status Indication.

Terminal number is 2(DI1) and 1(DI_COM) of Digital input group.

RUN: When the input of Digital input 1 is closed (at the rising edge), **“RUN” status** will

be highlighted if previous status was "STOP", and the program that is selected will start to run.

STOP: When the input of Digital input 1 is closed (at the rising edge), "**STOP**" status will be highlighted if previous status was "RUN", and the program that is selected will stop running.

(1-2) **HOLD:** Terminal number is 3(DI2) and 1(DI_COM) of Digital input group.

When Digital input 2 is ON, it **holds the running program** and when it is OFF, it continues to run the program

(1-3) **ADV:** Terminal number is 4(DI3) and 1(DI_COM) of Digital input group.

Each time Digital input 3 is ON, it **advances the processing** of a program by one segment.

(2) **Channel Select:** Terminal number is 7(DI6), 8(DI7) and 1(DI_COM)

When Digital input 6 and/or 7 are ON, channels are selected other external remote operations. **It is available for IPC5000D.**

- They are chosen by the status of DI (See chart below)

DI6	DI7	Operation	Status
ON	ON	Enabled both CHANNEL (CH1, CH2)	CH1, 2 - ON
ON	OFF	Enabled CH1, but disabled CH2	CH1 - ON
OFF	ON	Enabled CH2, but disabled CH1	CH2 - ON
OFF	OFF	Disabled both CHANNEL (CH1, CH2)	CH1, 2 - OFF

- **Default = Disable** both channel Input (CH1, 2 is **OFF**)

(Note) When current Control mode is synchronous mode(Figure 3.17.1), if either of DI6 or DI7 is ON, the remote control of Digital inputs is available.

(3) TROUBLE Status Indication :

Terminal of IPC5000D is 5(DI4), 6(DI5) and 1(DI_COM)

Terminal of IPC5000D is 5(DI4), 6(DI5), 7(DI6) and 1(DI_COM), 9(DI7) and 8(DI_COM)

When Digital **input 4 or 5 is ON**, The **trouble message** is displayed and operation mode of the controller is changed to a trouble status. And Control output is 0.0% and all digital output is OFF except digital output for TROUBLE. You can see the arrangement about Channel 1 or 2 of Digital input 4 and 5 on Table 2.6.2.

Refer the Section 3.18 for assigning Trouble Message.

(4) Program Number Selection

- When current status is only STOP mode, the selection can be enabled.
- Selection and indication are made according to the status of 'DI' below.

1	2	3	4	5	Program No. selected	
DI12	DI11	DI10	DI9	DI8	HEX	Decimal
OFF	OFF	OFF	OFF	OFF	00	0
OFF	OFF	OFF	OFF	ON	01	1
OFF	OFF	OFF	ON	OFF	02	2
OFF	OFF	OFF	ON	ON	03	3
OFF	OFF	ON	OFF	OFF	04	4
OFF	OFF	ON	OFF	ON	05	5
OFF	OFF	ON	ON	OFF	06	6
OFF	OFF	ON	ON	ON	07	7
OFF	ON	OFF	OFF	OFF	08	8
OFF	ON	OFF	OFF	ON	09	9
OFF	ON	OFF	ON	OFF	0A	10
OFF	ON	OFF	ON	ON	0B	11
OFF	ON	ON	OFF	OFF	0C	12
OFF	ON	ON	OFF	ON	0D	13
OFF	ON	ON	ON	OFF	0E	14
OFF	ON	ON	ON	ON	0F	15
ON	OFF	OFF	OFF	OFF	10	16
ON	OFF	OFF	OFF	ON	11	17
ON	OFF	OFF	ON	OFF	12	18
ON	OFF	OFF	ON	ON	13	19
ON	OFF	ON	OFF	OFF	14	20
ON	OFF	ON	OFF	ON	15	21
ON	OFF	ON	ON	OFF	16	22
ON	OFF	ON	ON	ON	17	23
ON	ON	OFF	OFF	OFF	18	24
ON	ON	OFF	OFF	ON	19	25
ON	ON	OFF	ON	OFF	1A	26
ON	ON	OFF	ON	ON	1B	27
ON	ON	ON	OFF	OFF	1C	28
ON	ON	ON	OFF	ON	1D	29
ON	ON	ON	ON	OFF	1E	30
ON	ON	ON	ON	ON	1F	31

(5) 'DO' Monitor & Force digital outputs

- If each digital input is ON, it is highlighted and if OFF, it is not highlighted.

Example :

If you register RUN mode event to digital output 1, now operation mode of IPC5000 is RUN mode, and you set digital output 1 to Normal type, this part will be displayed like below figure 3.6.2. If it is set as PWM, it can not be used for normal digital output type.

* DO-01display means Digital Output No. '01'.

DO	DO-01	DO-02	DO-03	DO-04	DO-05
	DO-06	DO-07	DO-08	DO-09	DO-10
	DO-11	DO-12	PWM DO-13	DO-14	

Fig. 3.6.2 Digital outputs ON/OFF status

- **Force digital outputs**(Only for test of digital outputs)
You can force digital outputs to ON or OFF by pressing the rectangle area of the digital output number. The force digital outputs are available for this screen. But if you exit this screen, the digital output will be OFF automatically.
- **Selection of PWM Control output or normal digital output.**
You can set digital output 1 and 2(Open Collector output) for Solid State Relay or Relay output DO13 and DO14 to PWM output. IPC5000 has 4 PWM (Pulse Width Modulation) for Time Proportional output. DO13 and DO14 mean Relay output terminals. In order to set output type of digital output 1, 2, DO13, or DO14, like figure 3.6.3, push the small box, and figure 3.6.4 will appear. You can only set this change in STOP mode.

The button to go to screen(Fig 3.6.4) to select whether it use Control output or normal digital output, but **DO13 and DO14 don't support normal digital output(for event output).**

* DO-01display means Digital Output No. '01'.

DO	DO-01	DO-02	DO-03	DO-04	DO-05
	DO-06	DO-07	DO-08	DO-09	DO-10
	DO-11	DO-12	PWM DO-13	DO-14	

Fig. 3.6.3 Digital output type selection

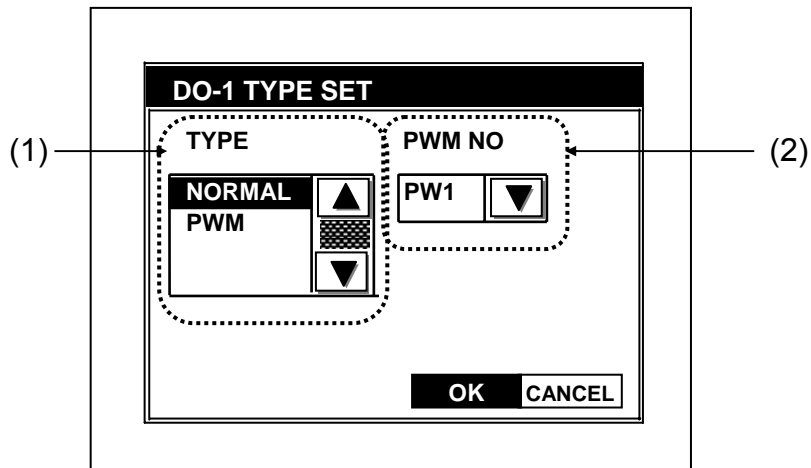

Fig. 3.6.4 DO TYPE SET screen

(1) 'DO' TYPE Setup.

- NORMAL: Setup for the use of EVENT output of normal 'DO'.
- PWM: Setup for the use of control output operation.

(2) PWM No. Setup.

- When setting to PWM , it is available. It can be set to items as below.
- For DO1 and DO2, it is impossible to use EVENT output when it is configured.

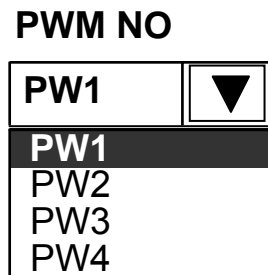

(a) IPC5000D

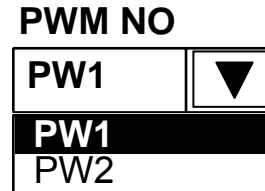

(b) IPC5000S

Fig. 3.6.5 Arranging PWM No. of Digital output

3.7 RANGE SET screen

PV/SP limit range and Square root can be set in this screen.

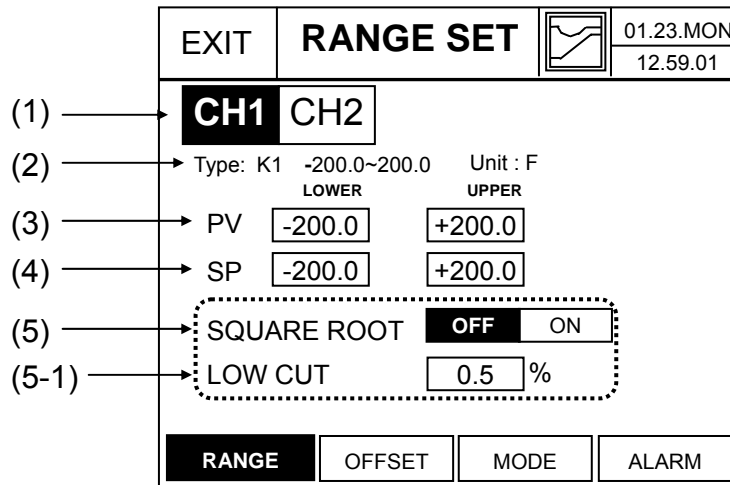

Fig. 3.7.1 RANGE SET screen

(1) **Channel Selection** button : It is available for **IPC5000D**.

(2) **TYPE and Unit** : Displaying full range and unit of Input Sensor type configured in 'AI SET' screen.

(3) **PV RANGE** Display and Setup

- PV low/high range is to limit the input from sensor and the limit range is **+/- 5%** of total PV low/high range and the out range of **+/- 5%** is displayed by OVER or UNDER.
- If the sensor type in AI SET(Section 3.3) is changed, PV low/high range also is changed to total range of the sensor type automatically.
- Low range of sensor type < PV LOWER < SP LOWER, SP UPPER < PV UPPER < High range of sensor type

(4) **SP RANGE** Display and Setup

- Limits user's set input like Target Set Point of Fix control or Segment etc.
- If the sensor type in AI SET(Section 3.3) is changed, SP low/high range also is changed to total range of the sensor type automatically.
- PV LOWER < SP LOWER < SP UPPER, SP LOWER < SP UPPER < PV UPPER

(5) **Square Root** computation(extraction)

- Pressing function selection ON/OFF button selects/cancels square root operation.

Default = OFF

(5-1) **LOW CUT**: sets the conversion limit value to input

- Linear Value is applied when under set value, and the equation below is applied when over the set value.

range = 0.0~5.0%(of input range)

computation equation : $Y = \sqrt{\frac{X}{10}}$ * Range (Range : PV High – PV Low)



Square root output

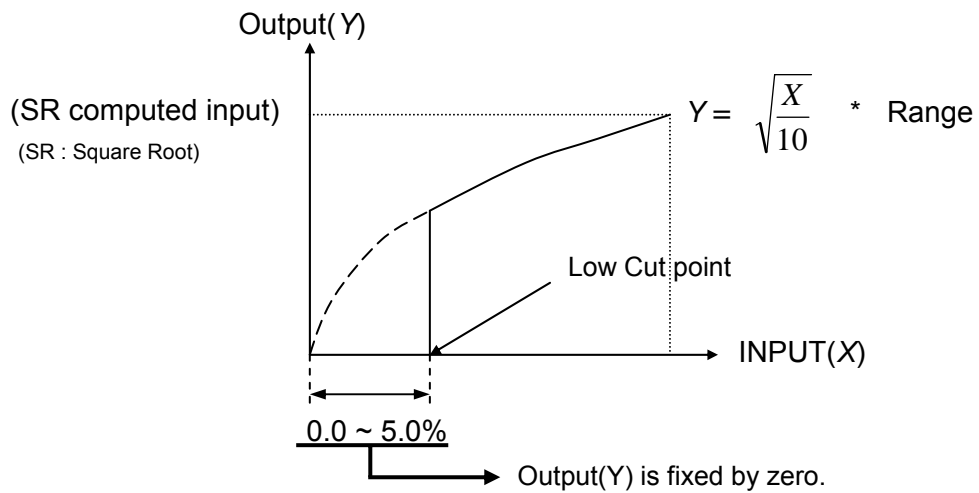

When a flowmeter of orifice or nozzle is used to measure flow, Square root computation is applied to convert differential pressure voltage signals into flow-rate signals. Low Cut value range = 0.0~5.0% (value of Ch1 < value of Ch2)

Example) Linear Voltage = 0.0 ~ 10.0, Range=0.0~1000.0,

1) Lowcut=0.1%(0.01V limit)

if input value = 1.0,

$$0.1\% : 1.0 = X : 1000.0, \therefore X = 0.01V$$

$$Y = \sqrt{\frac{X}{10}} * \text{Range} = \sqrt{\frac{0.01}{10}} * 1000.0 = 31.6 \rightarrow \text{PV input}$$

3.8 OFFSET screen

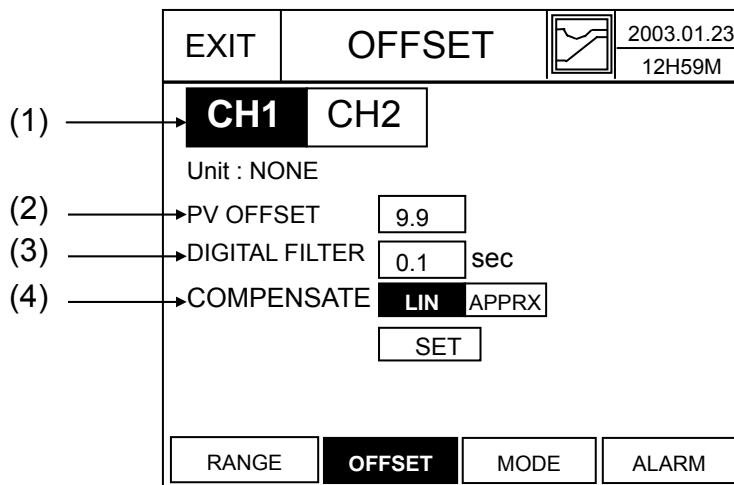

Fig. 3.8.1 OFFSET screen

- (1) **Channel Selection** Display : It is available for IPC5000D.
- (2) **PV Offset** Display and Input : Compensate the offset value of analog input.
 - $PV = \text{Analog input} + \text{OFFSET}$
 - Range: -99.9 ~ +99.9
- (3) **Digital Filter** Display and Input : The filter is used for preventing the quick change of analog input.
 - Range: 0.0 to 120sec(0.0 : Filter is OFF)
- (4) **Compensation**: compensatory function for input(Analog input)
 - LIN(Biasing) is used to correct input values affected by sensor deterioration. Apprx.(Approximation) is used to obtain capacity measurement signals when input signals and required measurement signals do not have a linear relationship, such as with spherical tank levels and capacities.
 - When 'SET' button is pressed, screen switches to the specified method setup screen ('COMPENSATE' screen)

3.9 Compensation set screen

This screen comes from Fig 3.8.1

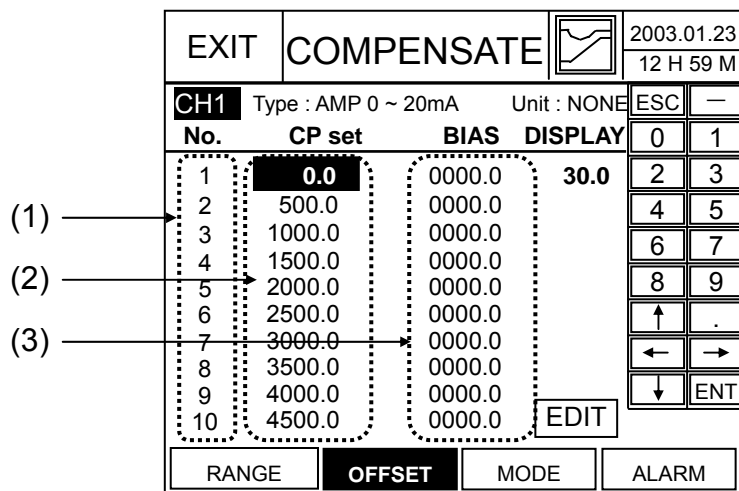

Fig. 3.9.1 Compensate set screen

(1) **ITEM Number** Display: displays up to 10

(2) **CP set (Correction Point):**

- Enters Correction Point input value at the specified item position. Typing in the input value with the keypad on the left and pressing 'ENT' key changes and saves the value. 'ESC' key cancels the process. Enter value in Engineering units. Also, input value can be moved with the direction keys of the keypad on the right.

Range = -5.0% to 105.5% of PV input range

Default = 0

(3) **BIAS** (Enter value in Engineering units)

- Enters BIAS input standby status at the specified item position.
- Range

LIN Bias = -99.9 to +99.9

Default = Refer to Table 3.6.1

APPRX = -5.0% to 105.0% of input range

Default = Refer to Table 3.6.1

Table 3.6.1 Defaults of compensation

No	LIN.		APPRX	
	CP set	BIAS	CP set	BIAS
1	105% of Input range	0.0	-5% of Input range	-5% of Input range
2~10	105% of Input range	0.0	105% of Input range	105% of Input range



Compensation

Selection Method: Sets 2-way temperature PV compensation.

1) **Lin. (Linearization) BIAS:** compensation of influence due to sensor deterioration

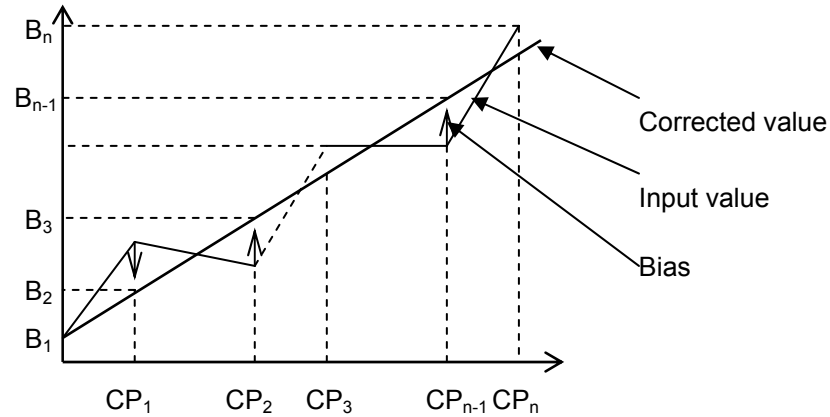

2) **Aprx. (Approximation):** Uses a random slope at each Line-Segment to calculate and display a PV signal.

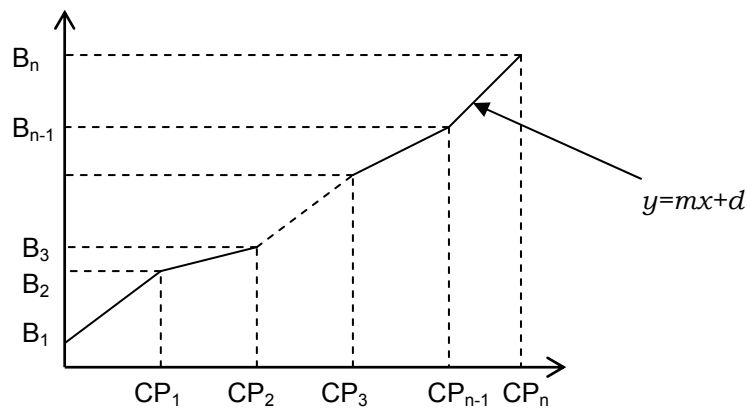

$y=mx+d$, (d : y-intercept, m : slope of the line passing the two points)

CP_n : peak point (Correction Point / line –segment break point)

B_n : Compensation value for each peak points (BIAS for Compensation)

3.10 EVENT SET

- IPC5000 has **12 events** in case of synchronous mode and each 6 events for channel 1 and 2 in case of asynchronous mode. And multiple events can be arranged to the same digital output.
- Event TYPE

Signal No	Signal name	Description	Used range	Set Position
00	EVENT OFF	Event output OFF	Only Program control	User set area
01	EVENT ON	Event output ON	Only Program control	User set area
02~17	TIME EVENT (For detail, refer to User Manual)	ON Delay and Cutback	Only Program control	User set area
21~40	PV EVENT	OFF/ON according to a changing of PV, SP, DEV, and MV	Program and Fix control	User set area
41~60	MODE EVENT	STOP	Program and Fix control	Maker set area
		RUN		
		READY		
		END		
		HOLD		
		ADV		
		WAIT		
		Auto Tune		
		Manual		
		FIX		
		DOWN		
61~80	ALARM Event	Alarm event output	Program and Fix control	Maker set area

(NOTE 1)

Mode and Alarm Event can assign the digital output number directly in the event set screen. And Event OFF/ON, Time Event or PV Event can assign digital output number in the Fix Set screen or Segment set screen of program. The digital number that Mode or Alarm event already is assigned can be not assigned to Time Event and PV Event. Refer to the user manual for Fix and Segment set screen.

(NOTE 2)

User set area : User area who use some Equipment or System and it is a input part to set at Fix or program.

Maker set area : Maker area who install or make a trial run of some Equipment or System and it is a input part to set at Mode or Alarm event.



Example to arrange Events to Digital outputs

1. When Fix control and synchronous mode, if you need 3 Mode events (RUN, END, DOWN), 3 PV events (11,12, 21), and 1 Alarm event. You can arrange signals like below. And like figure 3.10.1, the event part has to be set in Fix Set screen.

Digital input terminal	EVENT number	Description	Set Items
1	42	RUN	Event number in Figure 3.12.1 : 42 Mode : RUN Digital output number : 01
2	44	END	Event number in Figure 3.12.1 : 44 Mode : END Digital output number : 02
3	51	DOWN	Event number in Figure 3.12.1 : 51 Mode : DOWN Digital output number : 03
4	11	PV Event PV/ABS/LOW(CH 1)	Set the event number like Figure 3.10.1 in Fix Set screen.(Refer to User manual)
5	12	PV Event PV/ABS/LOW(CH 2)	
6	21	PV Event SP/ABS/LOW(CH 1)	
7	70	Alarm	Event number in Figure 3.12.1: 70 Digital output number : 07
8	-	Not used	
9	-	Not used	
10	-	Not used	
11	-	Not used	
12	-	Not used	

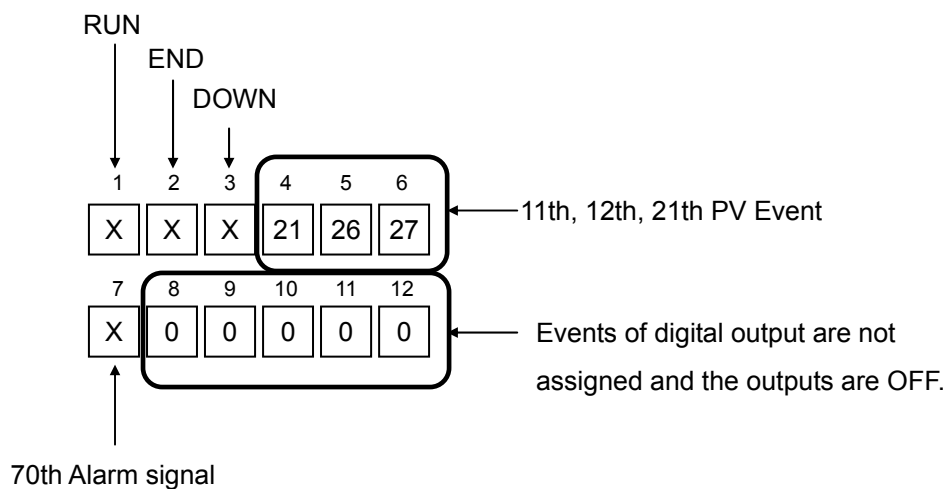

Fig. 3.10.1 The part to arrange events to digital outputs on FIX SET screen of User Manual

2. When Program control and Synchronous mode, if you need 3 mode events (RUN, END, DOWN), 3 PV events (21,26,27), 1 Alarm event (70), 2 Time Events (1,13), You can arrange the events like below, in case that set them to segment No. 0 of program No. 0. And like Figure 3.10.2, the event part has to be set in Segment Edit screen.

Digital input terminal	Event number	Description	Set Items
1	42	RUN	Event number in Figure 3.12.1 : 42 Mode : RUN Digital output number : 01
2	44	END	Event number in Figure 3.12.1 : 44 Mode : END Digital output number : 02
3	51	DOWN	Event number in Figure 3.12.1 : 51 Mode : DOWN Digital output number : 03
4	11	PV Event PV/ABS/LOW(CH 1)	Set the event number in segment No. 0 of program No. 0 like Figure 3.10.2 in Segment Edit screen.(Refer to User manual) Event numbers are equal to 12 but the OP Point or Differential value can not same with each other.
5	12	PV Event PV/ABS/LOW(CH 2)	
6	12	PV Event SP/ABS/LOW(CH 1)	
7	70	Alarm Event	Event number in Figure 3.12.1: 70 Digital output number : 07
8	1	ON Event	Event ON(Refer to User manual)
9	2	Time Event	Set the event number in segment No. 0 of program No. 0 like Figure 3.10.2 in Segment Edit screen.(Refer to User manual)
10	-	Not used	
11	-	Not used	
12	-	Not used	

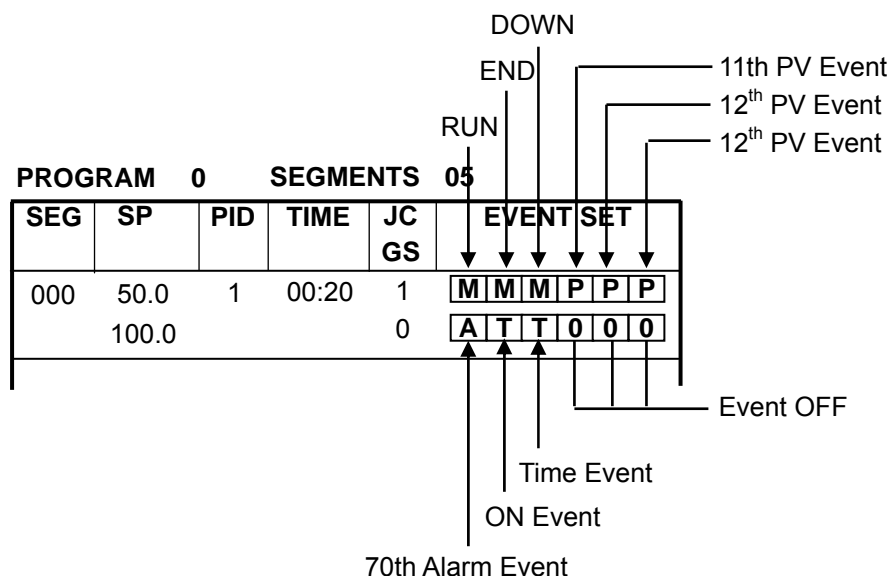

Fig. 3.10.2 The part to arrange PV and Time events to digital outputs on SEG EDIT screen of User Manual

3.11 MODE Event set screen

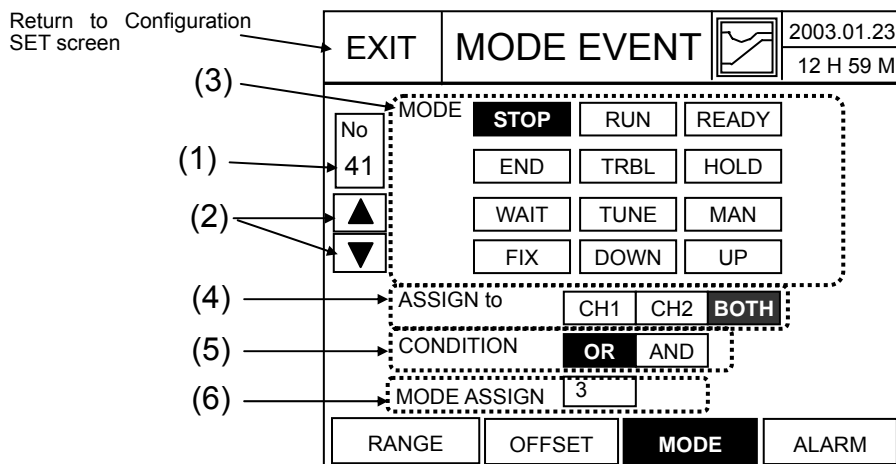

Fig. 3.11.1 MODE EVENT SET

(1) **EVENT No.** Display and Input

- EVENT No. for setup(21 ~ 40)
- The EVENT No. display to be set and buttons for input take place on the left. After this button is pressed, use the keypad on the right pressing the 'ENT' key after the input changes the value and it's saved, pressing 'ESC' key cancels the process.

(2) **Changing EVENT No.** for setup.

- ▲ (+) Increase : Whenever this button is pushed, the event No. increases by one.
- ▼ (-) Decrease : Whenever this button is pushed, the event No. decreases by one.

(3) **EVENT Content** Display

- Highlighted according to 'EVENT No' configuration in (1) (See below Table).

Table 3.11.1 Mode Event information

ITEM	Description	Remarks
STOP	When Program STOP(Quit), ON	READY, END, BREAK, TROUBLE = ON
RUN	During RUN operating, ON	HOLD, TUNE, WAIT = ON
READY	READY before operating the program, ON	
END	When Program or Fix timer is completed and the state is END, ON	
TRBL	When Trouble status occur, ON	
HOLD	When HOLD in process, ON	
WAIT	When the state us WAIT, ON	
TUNE	In Auto tuning, ON	

ITEM	Description	Remarks
FIX	In operation of FIX control mode, ON	
DOWN	In running, when the working SP is decreased (DOWN), ON	
UP	In running, when the working SP is increased (UP), ON	

(4) **ASSIGN** channel display : It is available for IPC5000D.

- CH1 : Operates OFF/ON according to the mode of Channel(Loop) 1.
- CH2 : Operates OFF/ON according to the mode of Channel(Loop) 2.
- BOTH : Operates OFF/ON according to OR or AND status of both channel selected by the selector(5).

(5) **CONDITION** button : It is available for IPC5000D.

- In item (5), **displayed when 'BOTH' button is selected**. Pressing the button will reverse its display.

- **OR** : Channel 1 and 2 operation is ON/OFF according to OR Condition.

(Example) If Mode of Mode event for a Digital output is "TUNE", the Digital output is operated like below.

Channel 1	Channel 2	DO operation
RUN(0)	RUN(0)	OFF
TUNE(1)	HOLD(0)	ON
HOLD(0)	TUNE(1)	ON
TUNE(1)	TUNE(1)	ON

- **AND** : Channel 1 and 2 operation is ON/OFF according to AND Condition.

(Example) If Mode of Mode event for a Digital output is "TUNE", the Digital output is operated like below.

Channel 1	Channel 2	DO operation
RUN(0)	RUN(0)	OFF
TUNE(1)	HOLD(0)	OFF
HOLD(0)	TUNE(1)	OFF
TUNE(1)	TUNE(1)	ON

(6) **EVENT Output Registration** : Registers the set mode event to actual digital output number.

- If the value is zero, the mode event is not assigned to a digital output. So To cancel the assigning, set the value to zero.

-
- Refer to the table 3.11.2 of next page for digital output number assigned by REGISTRATION number.

Table 3.11.2 DO information assigned by REGISTRATION number

REGISTRATION number	Digital output number	Terminal number
0	No Registration	
1	Digital output 1	2
2	Digital output 2	3
3	Digital output 3	4
4	Digital output 4	5
5	Digital output 5	6
6	Digital output 6	7
7	Digital output 7	9
8	Digital output 8	10
9	Digital output 9	11
10	Digital output 10	12
11	Digital output 11	13
12	Digital output 12	14

Note : If the digital output 1 or 2 is assigned for PWM control output, it is not registered.

3.12 ALARM EVENT SET screen

ALARM: meter instrument warning

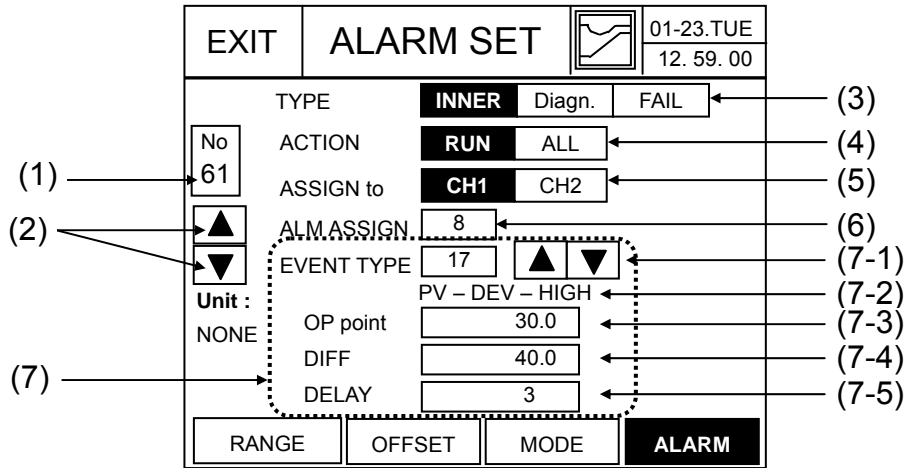

Fig. 3.12.1 ALARM SET screen

(1) EVENT No. Input and Display

- Type in the SIGNAL No to edit or configure. Then press 'ENT' button to move to the corresponding signal No.
- Set Range: 61~80

(2) Changing EVENT No. for setup.

- ▲ (+) Increase : Whenever this button is pushed, the event No. increases by one.
- ▼ (-) Decrease : Whenever this button is pushed, the event No. decreases by one.

(3) ALARM TYPE: alarm type selection

- **INNER** : A Digital output operates according to inner data already set without assigning event number. Or it is not necessary to assign digital output and event data in Fix set or Program segment edition screen like PV or Time event. INNER type is same data with event set of Fix set screen and the set part is same with (7) of figure 3.12.1.
- **DIAGNOSIS**: Triggered when in 'PV Input Burn-out' state. Set to MV OUPUT = 0.0%. If the DIAGNOSIS is selected, (7) part of figure 3.12.1 disappears.
- **FAIL**: Triggered when SRAM, Flash Memory error, Program DATA error, initial operation due to Power Failure, Auto-tuning fail, etc. occurs. If the FAIL is selected, (7) part of figure 3.12.1 disappears.

(4) **ALARM ACTION** : Selects alarm condition.

- **RUN** : Alarm output enabled at 'RUN' mode.
- **ALL** : Alarm output enabled at all time.

(5) **ALARM Assign to** : Selects channel for operation. It is available for IPC5000D.

(6) **ALM ASSIGN** : Registers the set alarm event to actual digital output number.

- If the value is zero, the mode event is not assigned to a digital output. So To cancel the assigning, set the value to zero.
- Digital output number assigned by REGISTRATION number is same with Mode Event.
Refer to Table 3.11.2

(7) **Data set part related to INNER alarm type.**

(7-1) **Event type number set**

- Sets event type number for OFF/ON operation of digital output. Event type number can be set by Keypad directly or Up and Down arrow button.
- Whenever Up and Down arrow button is pushed, (7-2) of figure 3.12.1 displays operation description of the event type. So event type for operation can be selected.
- Refer to Table 3.12.1 for Description by Event type number.

(7-2) **Event type number description**

- Explains the operation of selected event type number.
- Refer to Table 3.12.1 for more detail.

(7-3) **Operation Point or Max value**

- The operation point for OFF/ON is changed according to event type number.
- Refer to Table 3.12.1 and 2 for more detail.

(7-4) **Differential or Min value**

- The operation point for OFF/ON is changed according to event type number.
- Refer to Table 3.12.1 and 2 for more detail.

(7-5) **Delay time**

- Sets delay time for OFF/ON.
- Set range : 1 ~ 99 seconds

Table 3.12.1 Alarm Event Flowchart

Target	Type	Channel	Description	OP point value	Differential value	Delay Time
PV Measured Value	11/12	CH1/CH2	PV-ABS-LOW	-19999~20000	0~1000SPU	0~99sec
	13/14	CH1/CH2	PV-ABS-HIGH	-19999~20000	0~1000SPU	0~99sec
	15/16	CH1/CH2	PV-DEV-LOW	-19999~20000	0~1000SPU	0~99sec
	17/18	CH1/CH2	PV-DEV-HIGH	-19999~20000	0~1000SPU	0~99sec
SP Setting Value	21/22	CH1/CH2	SP-ABS-LOW	-19999~20000	0~1000SPU	0~99sec
	23/24	CH1/CH2	SP-ABS-HIGH	-19999~20000	0~1000SPU	0~99sec
MV Output Value	31/32	CH1/CH2	MV-ABS-LOW	-5.0 ~ 105.0 %	0.0 ~ 100.0 %	0~99sec
	33/34	CH1/CH2	MV-ABS-HIGH	-5.0 ~ 105.0 %	0.0 ~ 100.0 %	0~99sec

Target	Type	Channel	Description	Max Value	Min Value	Delay Time
SP Setting Value	25/26	CH1/CH2	SP-DEV-OFF	-19999~20000	-19999~20000	0~99sec
	27/28	CH1/CH2	SP-DEV-ON	-19999~20000	-19999~20000	0~99sec
DV Segment Target Value	31/32	CH1/CH2	DV-DEV-OFF	-19999~20000	-19999~20000	0~99sec
	33/34	CH1/CH2	DV-DEV-ON	-19999~20000	-19999~20000	0~99sec

(NOTE 1) When setting the Max/Min value, the Max value should be greater than the Min one.

(NOTE 2) See the table 3.12.2 in the next page for details on Alarm event On/Off operation algorithm.

For Type number in IPC5000S, it is available for odd number.

Table 3.12.2 Alarm Event On/Off Operation Algorithm

No	Description	Data Setting Range	No	Description	Data Setting Range
11 12	<p>PV-ABS-LOW</p>	<p>DIFF (0~1000SPU) OP point (-19999~20000)</p>	21 22	<p>SP-ABS-LOW</p>	<p>DIFF (0~1000SPU) OP point (-19999~20000)</p>
13 15	<p>PV-ABS-HIGH</p>	<p>DIFF (0~1000SPU) OP point (-19999~20000)</p>	23 24	<p>SP-ABS-HIGH</p>	<p>DIFF (0~1000SPU) OP point (-19999~20000)</p>
15 16	<p>PV-DEV-LOW</p> <p>OP = SP+Deviation SP: Variable setting value (Working SP)</p>	<p>DIFF (0~1000SPU) OP point (-19999~20000)</p>	25 26	<p>SP-DEV-OFF</p> <p>If SP is between upper and lower limit value, it is OFF. Otherwise, it is ON. SP: Variable setting value (Working SP)</p>	<p>Max. (-19999~20000) Min. (-19999~20000)</p>
17 18	<p>PV-DEV-HIGH</p> <p>OP = SP+Deviation SP: Variable setting value (Working SP)</p>	<p>DIFF (0~1000SPU) OP point (-19999~20000)</p>	27 28	<p>SP-DEV-ON</p> <p>If SP is between upper and lower limit value, it is ON. Otherwise, it is OFF. SP: Variable setting value (Working SP)</p>	<p>Max. (-19999~20000) Min. (-19999~20000)</p>
35 36	<p>MV-ABS-LOW</p>	<p>DIFF (0.0~100.0%) OP point (-5.0~105.0%)</p>	31 32	<p>DV-DEV-OFF</p> <p>If DV is between upper and lower limit value, it is OFF. Otherwise, it is ON. DV: Destination Value</p>	<p>Max. (-19999~20000) Min. (-19999~20000)</p>
37 38	<p>MV-ABS-HIGH</p>	<p>DIFF (0.0~100.0%) OP point (-5.0~105.0%)</p>	33 34	<p>DV-DEV-ON</p> <p>If DV is between upper and lower limit value, it is ON. Otherwise, it is OFF. DV: Destination Value</p>	<p>Max. (-19999~20000) Min. (-19999~20000)</p>

The type number of each operation is same for CH1 and CH2. (11/12 = CH1/CH2)

3.13 CONTROL SET screen

This screen is made up setting the preset type of manual output and the method to select the PID control parameter and ZONE.

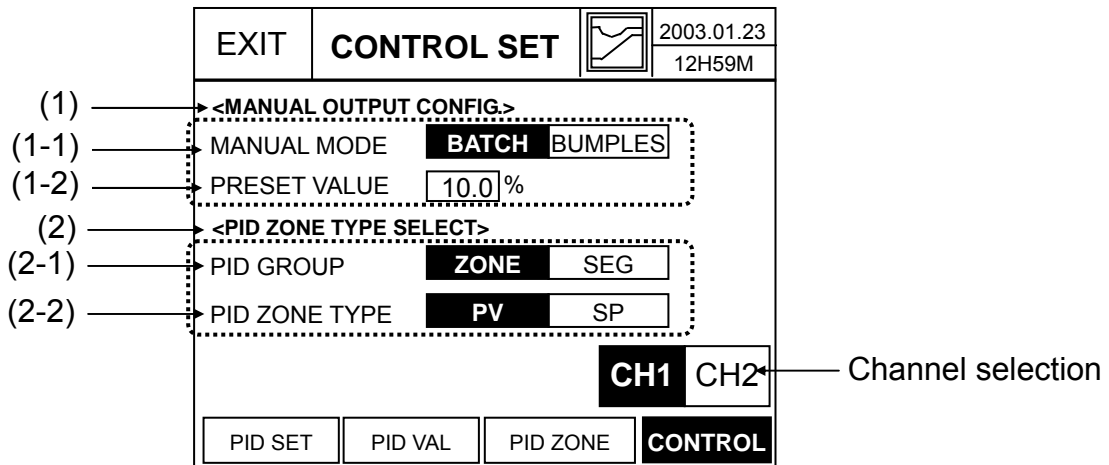

Fig. 3.13.1 CONTROL SET screen

For Channel selection, it is available for IPC5000D.

(1) **MANUAL OUTPUT CONFIG:** Sets manual output configuration according to each channel.

(1-1) **MANUAL MODE:** Sets MV output standard during operation control switchover from AUTO mode → MANUAL mode.

- **BATCH:** When this button is selected, during operation switchover, MV output is switched to the **Preset value** of (1-2) regardless of the previous output.
- **BUMPLES:** When the operation is selected, MV output is set depending on the PID output value.

(1-2) **PRESET VALUE:** When the manual mode is selected by “Batch”, sets the control output value for preset.

(2) **PID ZONE TYPE SELECT**

(2-1) **PID GROUP:** Determines PID group selection type to be applied in actual PID control and Auto-Tuning.

- **ZONE:** PID values are automatically determined according to the specified ZONE.
- **SEG (Segment):** PID selection is specified in Segment edition screen.

(2-2) **PID ZONE TYPE:** When PID GROUP(2-1) is selected as ZONE, Sets the standard to determine PID Zone automatically.

- **PV :** ZONE is selected automatically according to PV.
- **SP :** ZONE is selected automatically according to Working Set Point.
- Refer to figure 3.13.2 for detail.



Example for selecting PID constant group of ZONE and SEGMENT PID.

• Zone PID

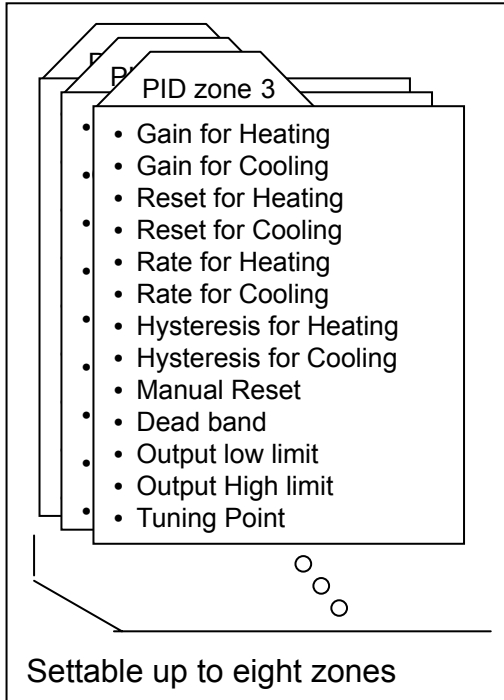

• Segment PID

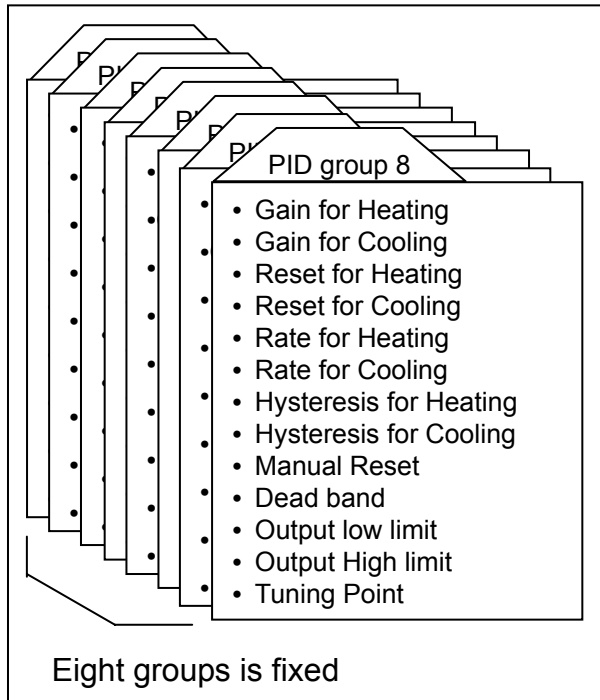

1. ZONE PID

PID ZONE can be divided up to eight according to setting T1 to T7 like figure 3.13.2. and PID ZONE number is selected by changing SP or PV automatically.

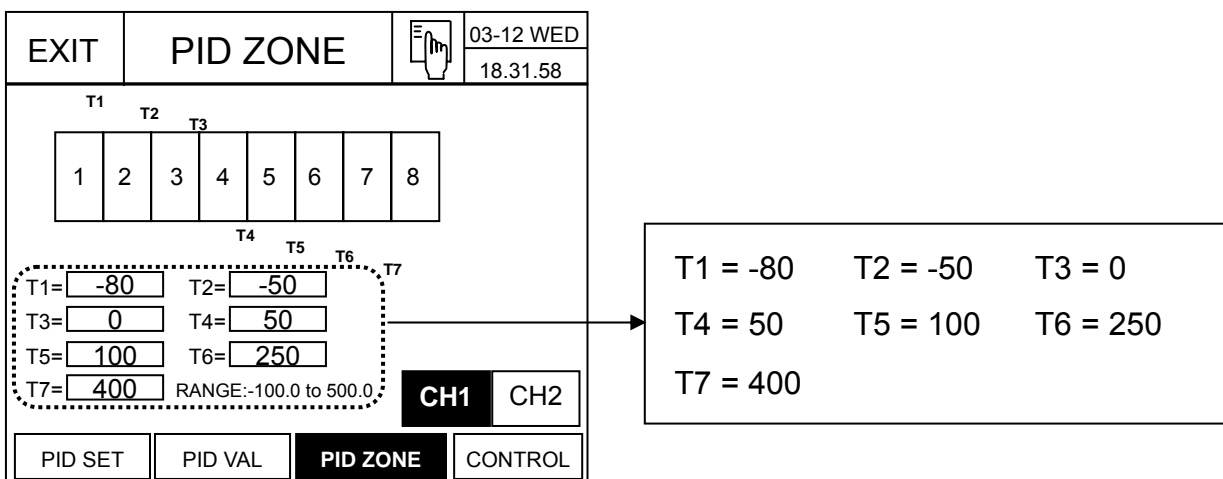

Fig. 3.13.2 PID ZONE Set screen

(Example 1)

If the PID ZONE type is SP, Working SP is 40.0 and like figure 3.13.2, T values are set, because the SP is between T3(0) and T4(50) by the figure, Zone number for PID control is four. So PID constants in ZONE 4 are operated for PID control.

(Example 2)

If the PID ZONE type is PV, the PV is 150.0 and like figure 3.13.2, T values are set, because the PV is between T5(100) and T6(250) by the figure, Zone number for PID control is 6. So PID constants in ZONE 6 are operated for PID control.

2. Segment PID

Segment PID is used for only program control and sets PID group number applied to PID control in Segment edition screen of program. It is like figure 3.13.3.

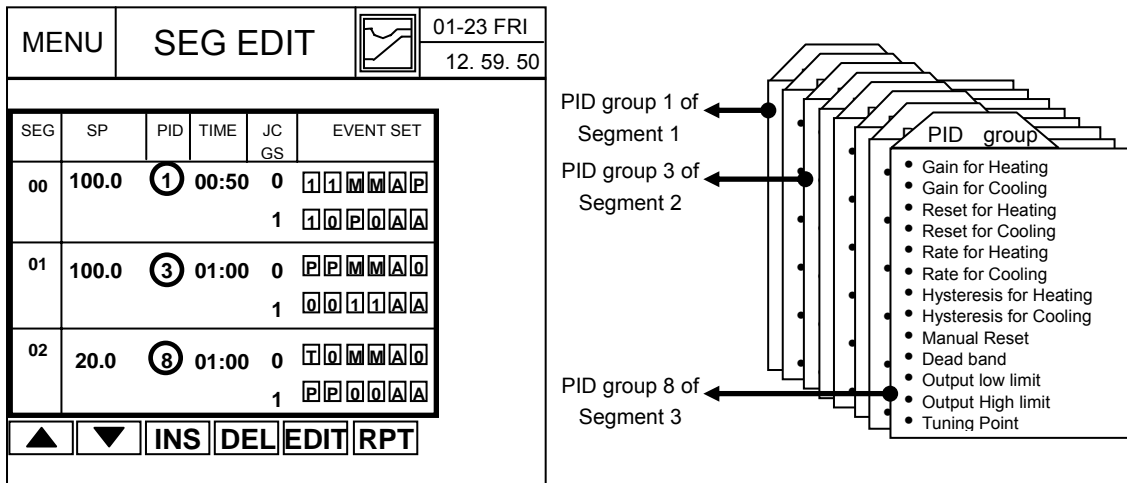

Fig. 3.13.3 Example for setting Segment PID group

3.14 PID ZONE SET screen

IPC5000 can have 8 different sets of PID constants based different setpoint or Process variable ranges.

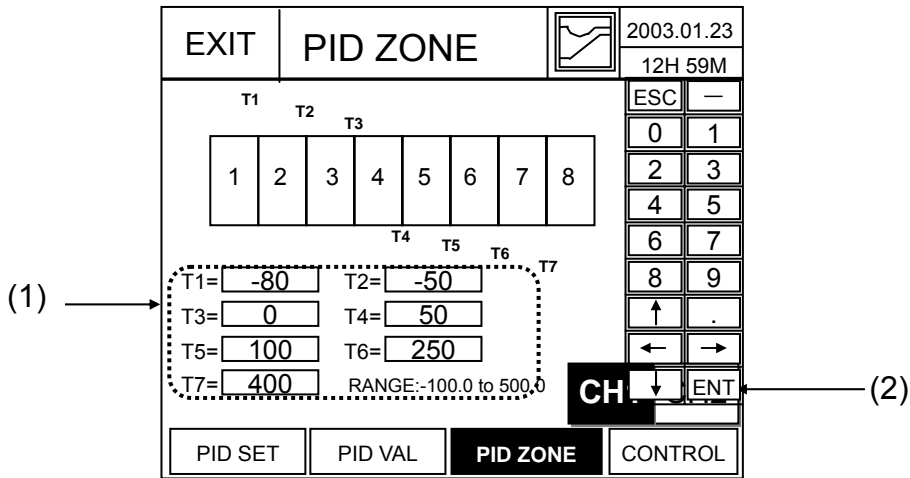

Fig. 3.14.1 PID ZONE SET screen

Change is **forbidden** under the 'RUN' operation.

(1) ZONE range configuration display & input

- ZONE configuration can be **divided from 1 to 8**
- Selection number is set up to the part typed in according to order.
- Magnitude of input value: $T1 < T2 < T3 < T4 < T5 < T6 < T7$
- Input range: LSPL to USPL ([RANGE SET/PV=])

(2) Channel selecting Button

- This button changes current Channel selection to the next Channel.
- When pressed, the button is highlighted.
- This button does not appear in [SETUP/CONTROL SET/Control mode = Single mode].



Screens set up by zone

1) The maximum of 8 zones:

When 8 zones are required, you may split into 1-8 zones in accordance with T1, T2, T3, T4, T5, T6, and T7 set-up.

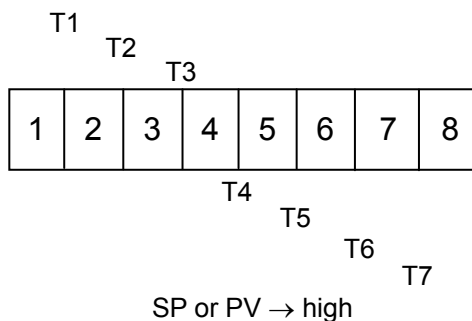

Set up values at T1, T2, T3, T4, T5, T6, and T7 and split into 8 zones.

2) 1 zone:

Set up at T1 = PV high limit value, T2 = PV high limit value... T7 = PV high limit value (initial value)

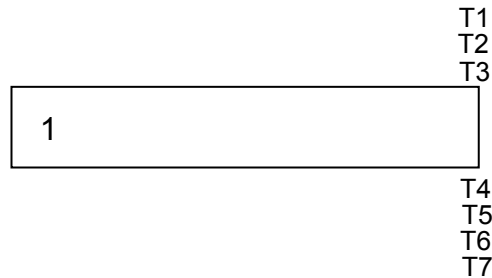

SP or PV → high

3) 2 zones:

Set up at T2 ~ T7 = PV high limit value. T1 must be set up at a value that defines zones.

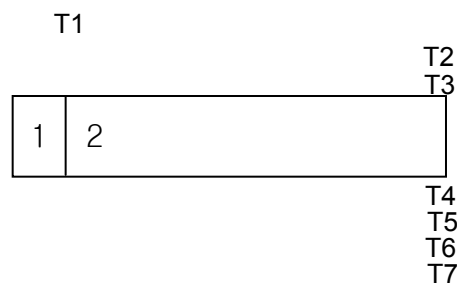

SP or PV → high

4) 3 zones:

Set up at T3 ~ T7 = PV high limit value. T1 and T2 must be set up at values that define zones.

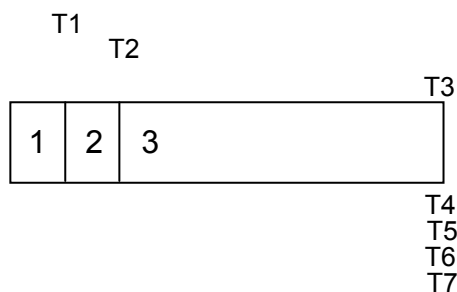

SP or PV → high

5) 4 zones:

Set up at T4 ~ T7 = PV high limit value. T1, T2 and T3 must be set up at values that define the zones.

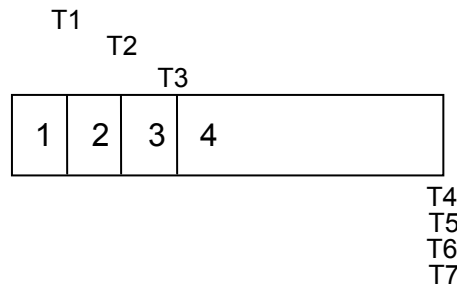

SP or PV → high

6) 5 zones:

Set up at T5 ~ T7 = PV high limit value. T1, T2, T3 and T4 must be set up at values that define the zones.

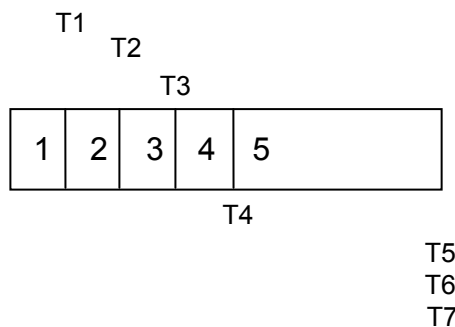

SP or PV → high

7) 6 zones:

Set up at T6 and T7 = PV high limit value. T1, T2, T3, T4 and T5 must be set up at values that define the zones.

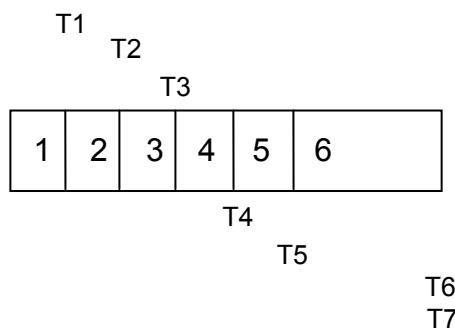

SP or PV → high

8) 7 zones:

Set up at T7 = PV high limit value. T1, T2, T3, T4, T5, and T6 must be set up at values that define the zones.

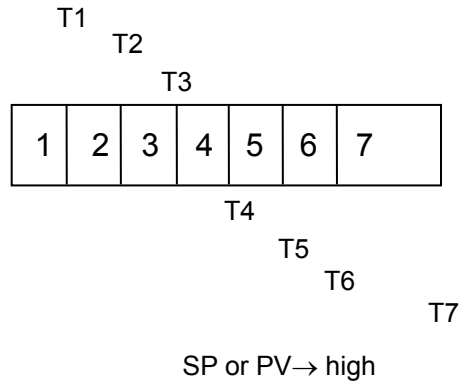

3.15 PID CONSTANT SET screen

Set PID Parameters according to each Group.

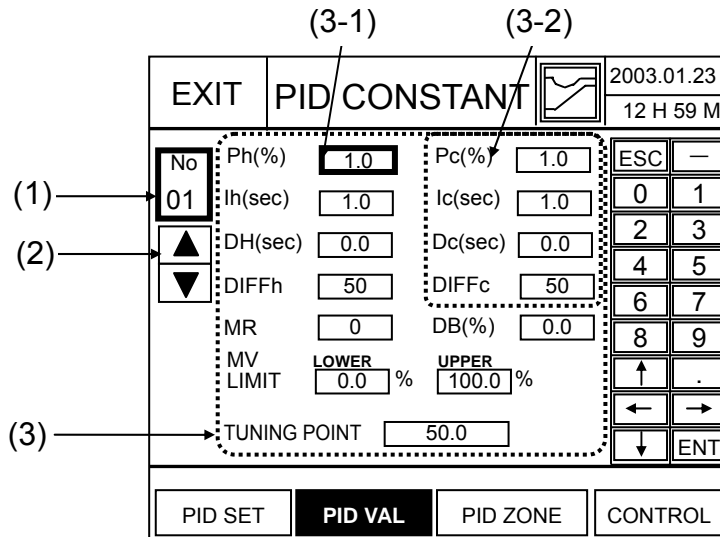

Fig. 3.15.1 PID Const set

(1) Display **PID Group** Number or PID Zone number

- Displays PID ZONE number or PID Group number according to <PID ZONE TYPE SELECT>.
- Initially, the PID number of this screen displays to be applying that currently.

(2) Selecting button of ZONE or Group number to edit

▲ (+) Increase: Whenever this button is pushed, the event No. increases by one.

▼ (-) Decrease: Whenever this button is pushed, the event No. decreases by one.

(3) PID constants and the related data to set

For range to set and description of each parameter, refer to table 3.15.1 on the following page.

(2-1) **Heating** Action Setup

- Set up & displayed on screen when [SETUP/PID SET/PID ALG=PIDA, PIDB, DUP-A, or DUP-B].

(2-2) **Cooling** Action Setup

- Displayed with contents of (2-1) when Heat/Cool control is selected.
[SETUP/PID SET/PID ALG = DUPA or DUPB]

- **Default value (factory setup)**

Table 3.15.1 Parameters on PID constants set screen

Parameter	Initial value	Range	Remarks
Ph	1.0 %	0.1~9999 % or 0.1 ~ 1000 %	Proportional band or Gain for Heating Value does change from PB or Gain. When the value is zero , ON/OFF Control or Duplex ON/OFF Control for Heating is operated.
Ih	1.0 min	00.02~50.00 min	Integral(Reset) for Heating Value does not change from MIN to RPT
Dh	0 min	00.00~10.00 min	Derivative(Rate) for Heating
DIFFh	50.0 %	0.0~100.0 % of PV span	Heating Differential(Hysteresis) only for ON/OFF Control
Pc	1.0 %	0.1~9999%	Proportional band or Gain for Cooling When the value is zero , Duplex ON/OFF Control is operated.
Ic	1.0 min	00.01~10.00min	Integral(Reset) for Cooling
Dc	0 min	00.02~50.00min	Derivative(Rate) for Cooling
DIFFc	50.0 %	0.0~100.0 % of PV span	Cooling Differential(Hysteresis) only for ON/OFF Control
MR	0 %	-100 ~ 100 %	Manual Reset: Only applicable if you do not use RESET (Integral time). Allows correction of output to account for load changes to bring the PV up to setpoint. When the value is not zero, Manual Reset is operated.
DB	1.0 %	Time duplex -5.0 ~ 25.0 % ON/OFF duplex 0 ~ 25.0 %	Dead Band
LOWER	0.0 %	-5.0 ~ 105.0 %	MV limit minimum value
UPPER	100.0 %	-5.0 ~ 105.0 %	MV limit maximum value
TUNING POINT	0.0 EU	According to SP limit range	Tuning point for automatic tuning

3.16 PID set screen

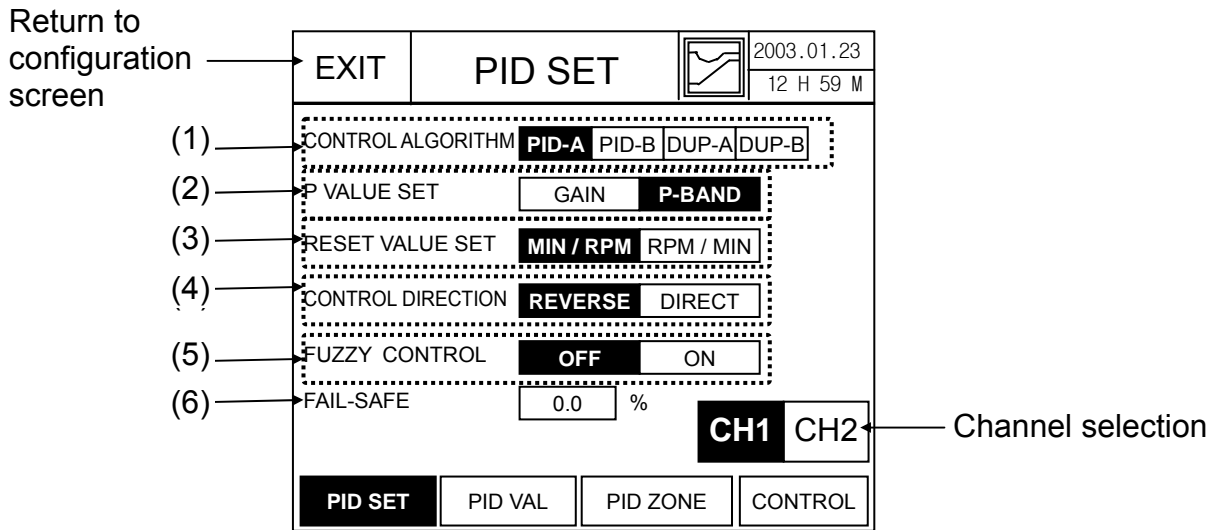

Fig. 3.16.1 PID SET screen

For Channel selection, it is available for IPC5000D.

(1) **Control Algorithm** selection button : It is changeable only at STOP mode.

- Button to select **PID Control** Algorithm.
- **PID-A** : This is three-mode control algorithm(P(Proportional), I(Integral),D(Derivative)) and used for most control field.
- **PID-B** : Unlike the PID A equation, the controller gives only an integral response to a setpoint change, with no effect on the output due to the gain or rate action, and it gives full response to PV changes. Otherwise controller action is as described for the PID A equation.
- **DUP-A** : PID-A algorithm for Heat/Cool control.
- **DUP-B** : PID-B algorithm for Heat/Cool control.

(2) **P-value Set** selection button

- Selects P (Proportional Band) value type

$$GAIN = \left| \frac{100\%}{P.B} \right|$$

P-BAND is the range indicated by the percentage of process value.

GAIN is the ratio of process value change (%) to output change (%).

(3) **Reset value set** selection button

- Selects the type applied to Reset value.
- **MIN / RPT**: Minutes per Repeat.
- **RPT / MIN**: Repeat per Minutes.

RESET (Integral) adjusts controller output according to variation (SP-PV) magnitude and lasting time. Amount of adjustment depends on that value, or the gain. Reset adjustments are measured according to the number of proportional action repetition per minute, or the number of minutes during which the proportional action repetition was taking place.

(4) **Control Direction** selection button : It is changeable only at STOP mode.

- Button to select Direct/Reverse operation of PID control operation.
- Reverse : Heating

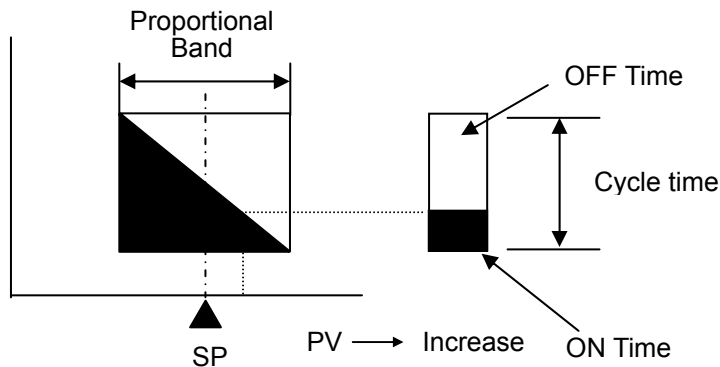

- Direct : Cooling

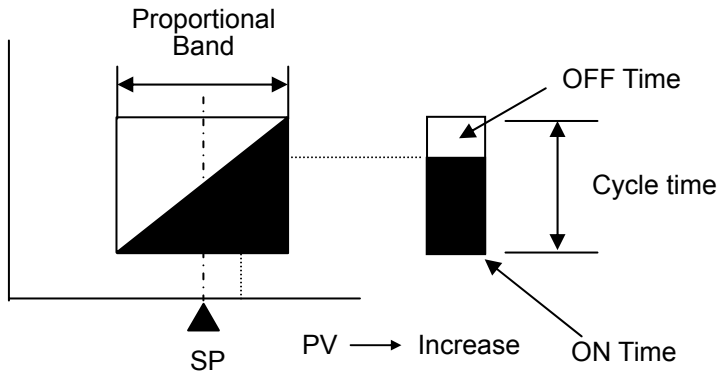

(5) **FUZZY** control selection button

- Selecting to enable or disable fuzzy control.

(6) **FAIL-SAFE:**

- When analog input sensor type is Voltage/mA(0~10V, 1~5V, 4~20mA..), if input fail status(Burn out, input high, input low) occurs, the control output become fail-safe value instead of PID control output.
- Set range: -5.0~105.0%

3.17 SYSTEM SET screen

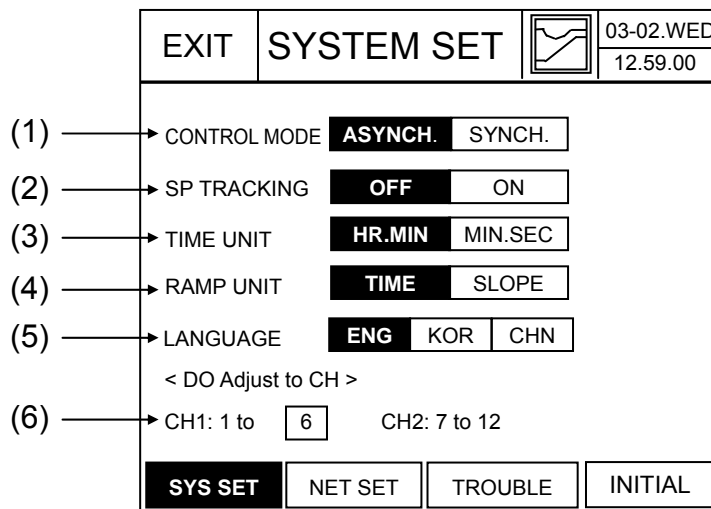

Fig. 3.17.1 SYSTEM SET screen

(NOTE)

To change the system data except LANGUAGE, set the controller operation mode to the STOP status first.

(1) Control Mode selection button

- Select whether control operation is synchronous or asynchronous. (Default = Asynchronous)
- **ASYNCH.** : Asynchronous mode that both channels operate independently.
That is, RUN and STOP can be operation for each channel.
- **SYNCH.** : Synchronous mode that both channels operate dependently.
That is, RUN and STOP runs with each channel.

(2) SP tracking

If the SP tracking is ON, the controller enters into the condition that program control changes to fix control when the last segment is completed. The next operation after completion of program operation is determined by the JC condition of the last segment and the SP tracking ON/OFF as shown in the Figure 3.17.2.

When the SP tracking function is enabled, the target setting value (SP) at the program end becomes the target setting value of the fix control. The PV event runs as the event set by the fix control and the time event does not work. SP tracking operation is enabled only when the SP tracking is on and the JC value at the last segment of the program is set to 2.

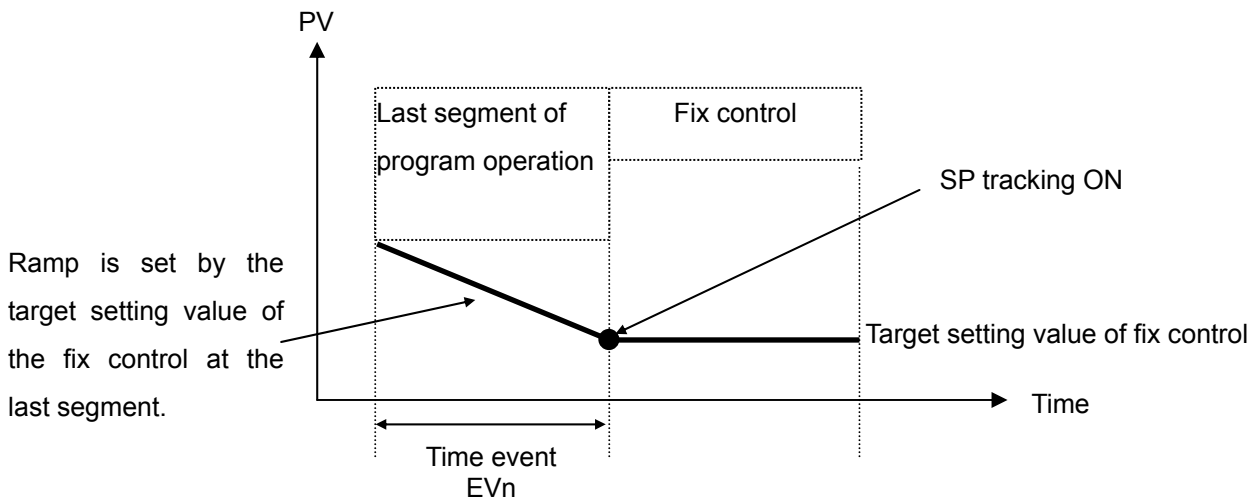

Fig. 3.17.2 Fix Control Operation when SP Tracking On and JC = 2

If **SP tracking is OFF**, the target setting value (SP) at the program end becomes the last target setting value. The PV event runs as the event of the fix control and the time event is disabled.

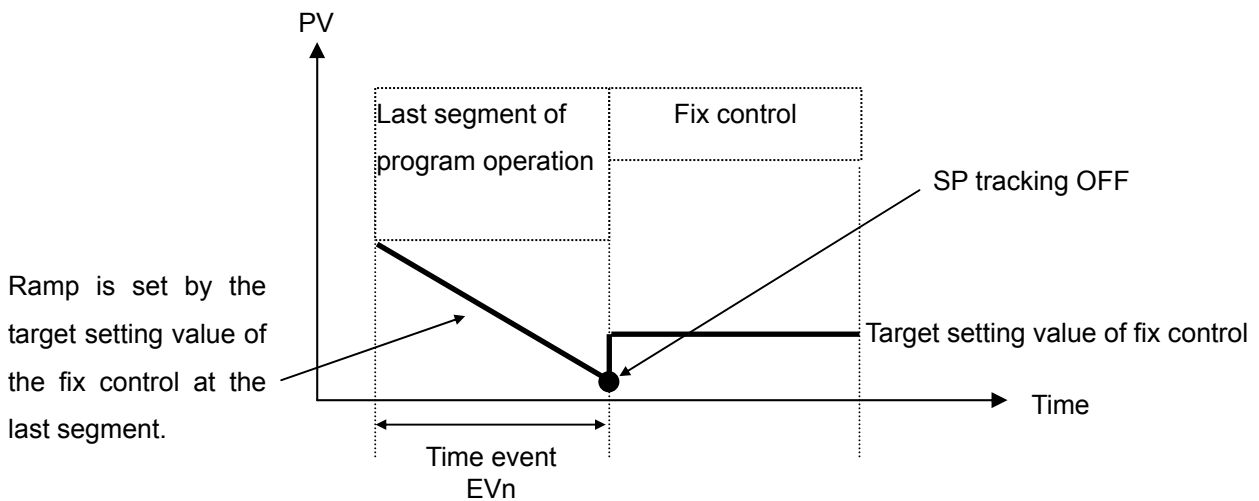

Fig. 3.17.3 Fix Control Operation when SP Tracking Off and JC = 2

(3) TIME UNIT setting button

- Sets the default time unit of IPC5000.
- HR.MIN: The minimum unit of the IPC5000 default time will be hour and minute.
- MIN.SEC: The minimum unit of the IPC5000 default time will be minute and second.

(4) RAMP UNIT type selection button

- Selects the ramp type for program or fix control.

TIME: Sets the ramp by the hour unit. The slope is set by the difference ratio of the previous target setting value and the current setting value. See the following figure.

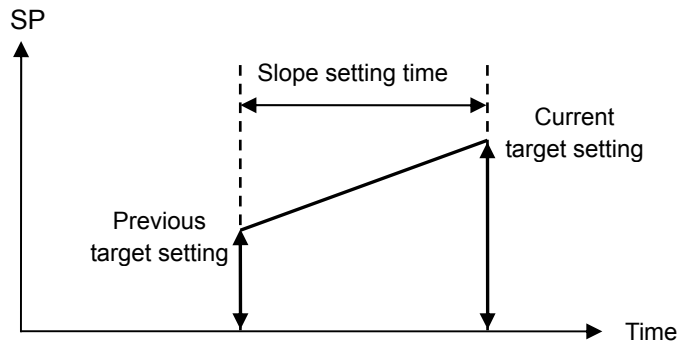

SLOPE: Sets the slope by the rate unit.

Input unit: SPU/MIN or SPU/SEC (SPU: Set Point Unit)

See the following figure.

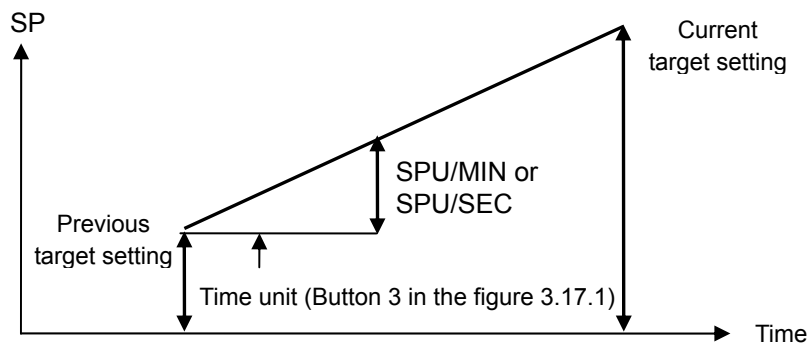

(5) LANGUAGE selection button

You can set or modify the language shown in the default menu and user interface screen.

Default = ENG (English)

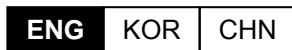

ENG: English, KOR: Korean, CHN: Chinese (non-simplified)

(6) Digital output channel adjustment

- For the asynchronous mode, 12 digital outputs are allocated by channel.
- For the synchronous mode, the setting section will be hidden.
- When allocating the digital outputs, the event setting section will appear as much as the number of digital output allocation in the segment editing window, whereas 12 event sections appear in the fix control setting screen. However, settings can be made according to channel allocation.

(Example 1) Input "8" if you want to use digital output 1 to 8 for channel 1 and other outputs for channel 2.

		PROGRAM	0	SEGMENTS	05		
CH 1	SEG	SP	PID	TIME	JC	EVENT SET	
					GS		
	000	50.0	1	00:20	1	M	M 0 P P P
					0	A	0

		PROGRAM	50	SEGMENTS	05		
CH 2	SEG	SP	PID	TIME	JC	EVENT SET	
					GS		
	000	120.0	1	00:20	1		
					0	T	0 0 0 0

(Example 2) Input "3" if you want to use digital output 1 to 3 for channel 1 and other outputs for channel 2.

		PROGRAM	0	SEGMENTS	05		
CH 1	SEG	SP	PID	TIME	JC	EVENT SET	
					GS		
	000	50.0	1	00:20	1	M	M 0
					0		

		PROGRAM	50	SEGMENTS	05		
CH 2	SEG	SP	PID	TIME	JC	EVENT SET	
					GS		
	000	120.0	1	00:20	1		P P P
					0	A	0 T 0 0 0 0

(Example 3) If you want to use all of 12 digital outputs for channel 2, input "0".

		PROGRAM	0	SEGMENTS	05		
CH 1	SEG	SP	PID	TIME	JC	EVENT SET	
					GS		
	000	50.0	1	00:20	1		
					0		

		PROGRAM	50	SEGMENTS	05		
CH 2	SEG	SP	PID	TIME	JC	EVENT SET	
					GS		
	000	120.0	1	00:20	1	M	M 0 P P P
					0	A	0 T 0 0 0 0

3.18 TROUBLE SET Screen

You can set the data related with the trouble messages and tune lock that are received from the digital inputs.

The messages that you set in (1) and (2) in the Figure 3.18.1 will be displayed when the ON signal is set for the trouble input, which enables you to identify the current trouble status. Press the “CLEAR” button to clear the message.

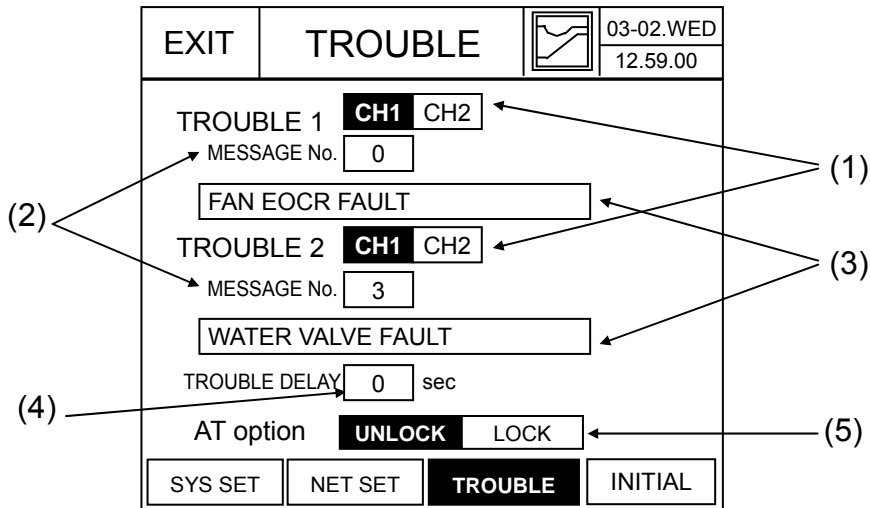

(a) IPC5000D

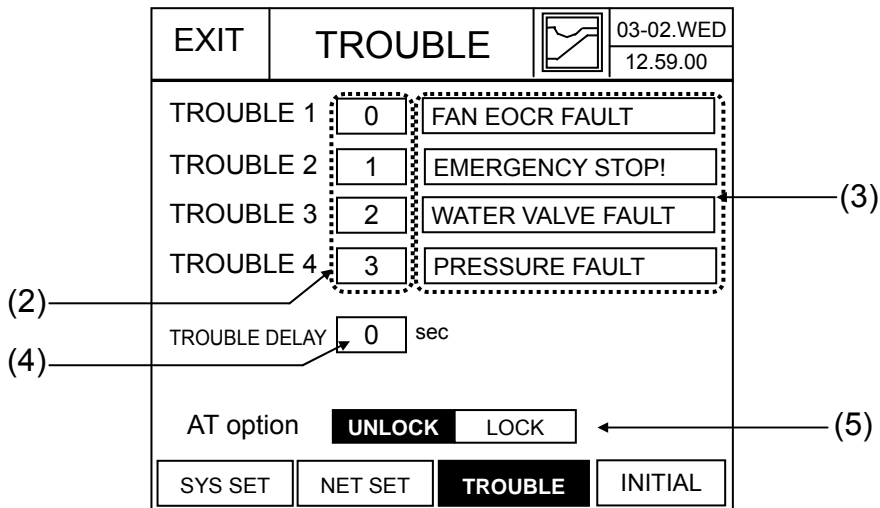

(b) IPC5000S

Fig. 3.18.1 Trouble and Tune Lock Setting Screen

- (1) Button to **Assign the channel** : It is available for Asynchronous mode of IPC5000D. Select the channel number to assign when trouble occur.
- (2) **Message number set** button
Input the number that is displayed in the trouble input message list. When you input the number displayed at the left side of the Figure 3.18.3, the message contents will be

displayed at (2).

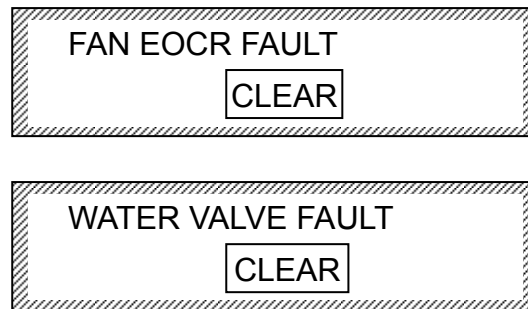

Fig. 3.18.2 Trouble Message Window

(3) **Message selection** button

When you press the button, the screen as shown in the Figure 3.18.3 will appear and you can allocate the message.

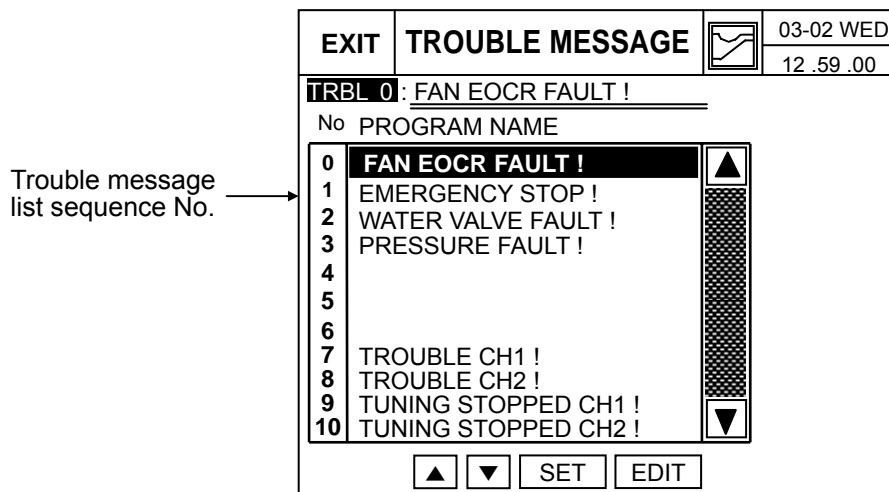
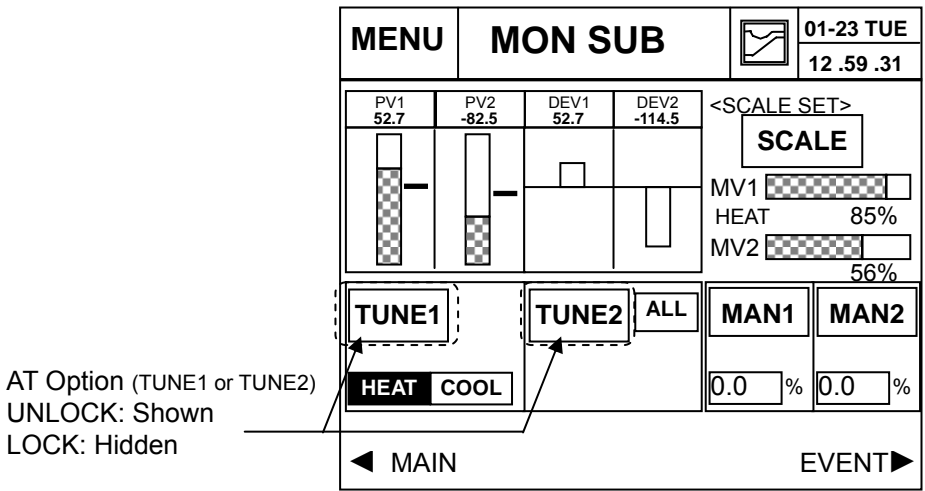

Fig. 3.18.3 Trouble Message List

(4) Button to input the delay time for the trouble message

If you set the delay time, the trouble output and message will be displayed after the set period of time when the trouble input is received. The delay time setting range is 0 ~ 99 seconds.

(5) AT Option (TUNE button lock/unlock)



(a) IPC5000D

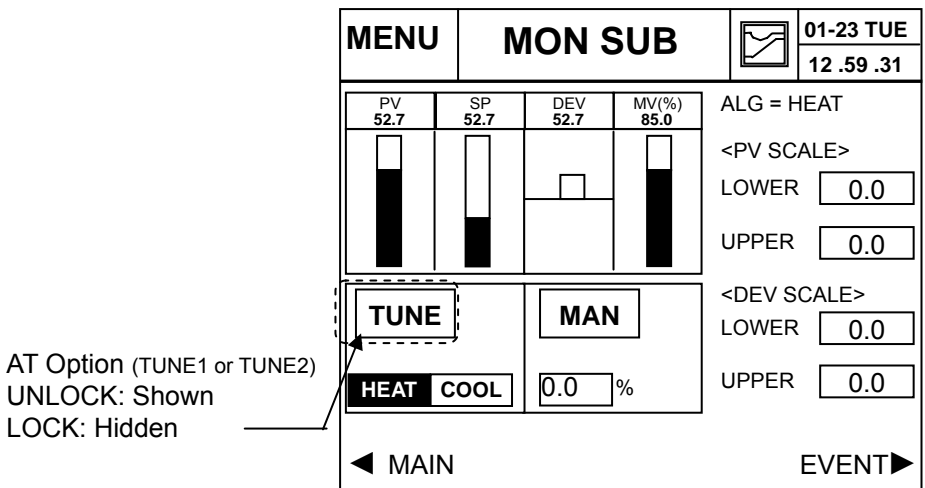

(b) IPC5000S

Fig. 3.18.4 MON SUB Screen

- The AT option is used to prevent auto tuning operation.
- If the AT option is set to “LOCK”, the channel 1 and 2 section will be hidden in the screen as shown in the Figure 3.18.4. Therefore, auto tuning cannot be performed.

3.19 TROUBLE MESSAGE set

You can assign up to 32 unique messages for the TROUBLE. Or you can edit the messages by using IPC5000 User Tool software.

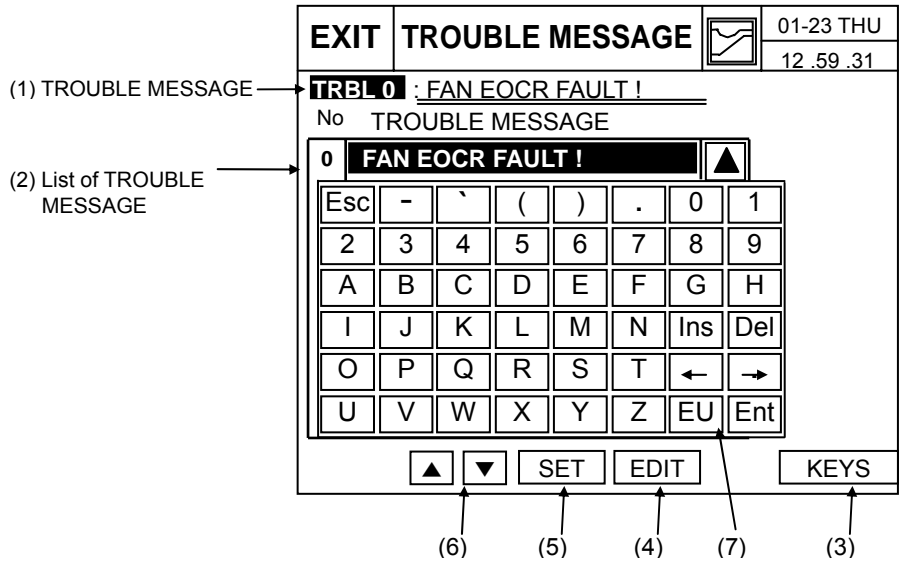

Fig. 3.19.1 Assigning the TROUBLE MESSAGE

By 'EDIT' button, it starts to edit the message. If you press the 'PAGE' button, the 11 messages are shown.

- (1) Displays the message of the TROUBLE.
- (2) Displays the list of TROUBLE MESSASGE and number.
- (3) 'KEYS' : Switches the keypad input mode – number, English character and special character, as follows.

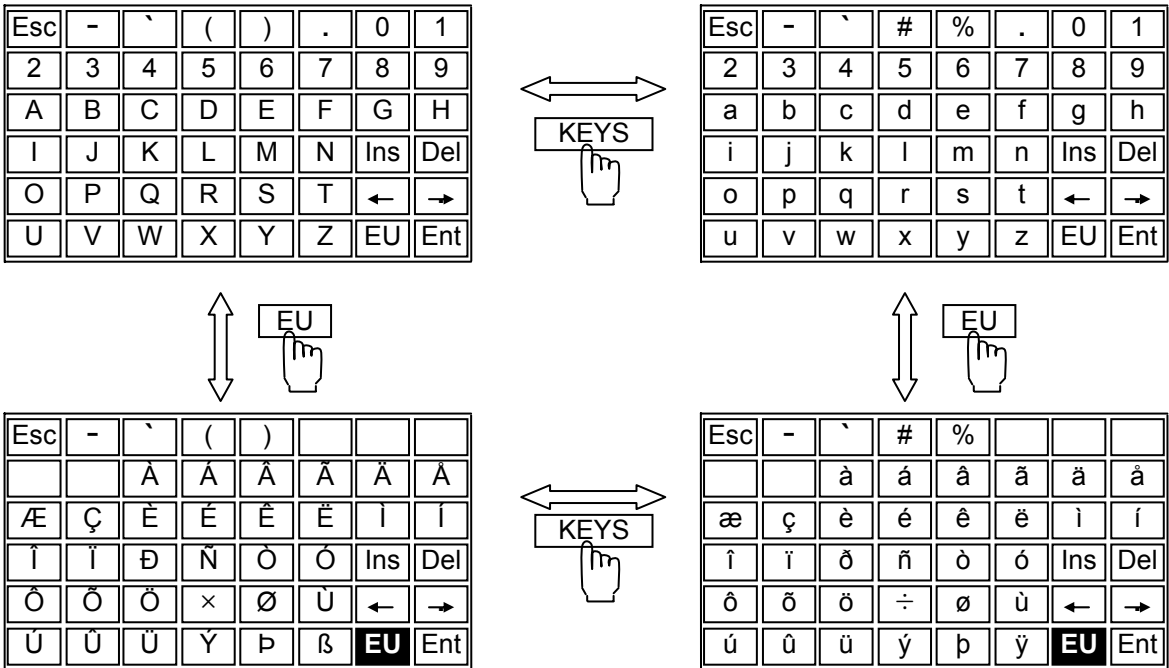

Fig. 3.19.2 Keypad Switching

- (4) If you press the 'SET' button, the message on cursor is selected.(Refer to 'TROUBLE SET screen')
- (7) If you press 'EU' button, switch the keypad to input European font.

3.20 NETWORK SET Screen

You can set the communication related parameters of IPC5000.

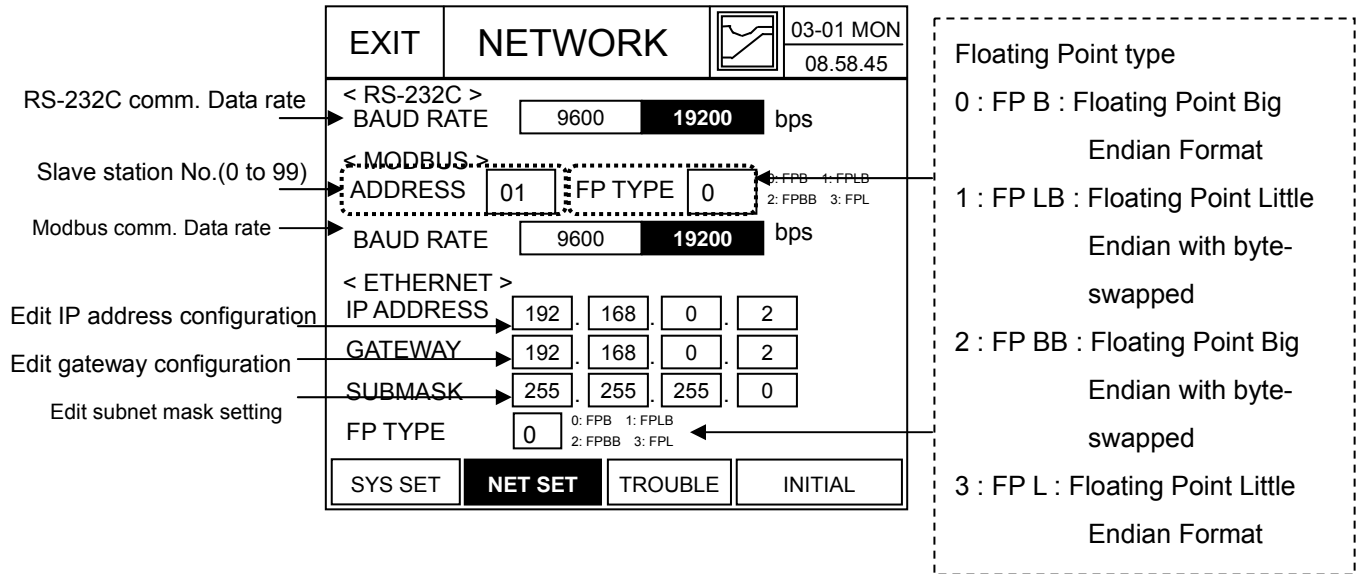

Fig. 3.20.1 Network Setting Screen

(NOTE)

Modbus and Ethernet communication features are enabled only for the models equipped with the communication option.

Refer to the communication manual for more details.

3.21 INITIALIZE screen

Initializes program data and display program version of IPC5000

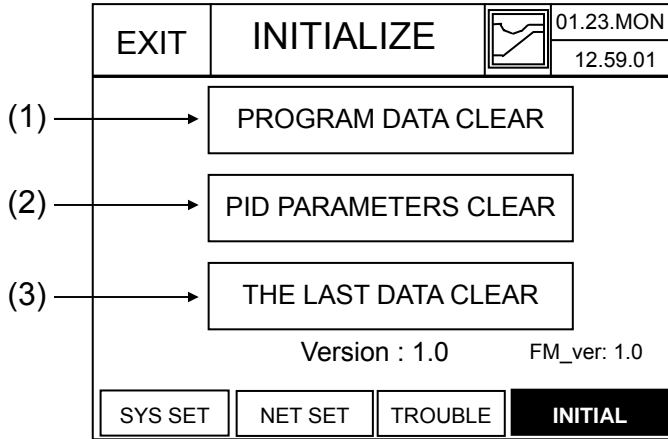

WARNING
Before initializing, **record data** to be clear, which you already have set, because you will be lost them.

Fig. 3.21.1 INITIAL screen

If the a certain button is pressed, the message box is shown as followings,

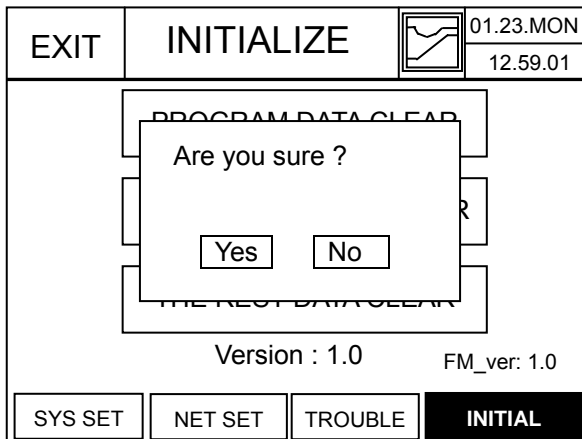

Fig. 3.21.2 Confirm for initializing

If the Yes button is pressed, initializes the data as followings.

(1) PROGRAM DATA CLEAR

- Initializes all PROGRAM DATA to initial value.
- SSP1/2, TSP1/2, TIME, JC, SIG SET = 0, Start mode = SSP, PID group number.

(2) PID PARAMETERS CLEAR

- Initializes all data related to PID parameter of Channel 1 and 2.
- Each PID parameter will be initialized like below Table 3.21.1

Table 3.21.1 Initial PID parameter list

Parameter	Initial value	Parameter	Initial value
Ph	1.0 %	Pc	1.0 %
Ih	1.0 min	Ic	1.0 min
Dh	0 min	Dc	0 min
DIFFh	50.0 %	DIFFc	50.0 %
MR	0 %		
DB	1.0 %		
LOWER	0.0 %		
UPPER	100.0 %		
TUNING POINT	0.0 EU		

(3) THE LAST DATA CLEAR

- Initialize all the rest data except PID and program data to default value.
- For example, the screens to be initialized are Operation set, Link set, Wait set, Extra set, PID set, PID zone set, Control set, Range set, Offset, Event set, Analog input/output Configuration, System set, DIO set, and PWM set.



Caution

In only STOP state, the initialization is executed.

Be careful!

You may lose all data if the initialization is executed.

4. Specification

- General Specifications

Items		Specification
Rated power supply voltage		100 to 240V AC, 37VA, 50/60Hz
Inrush current when power supply turns on		Lower than 50 A
Insulation Resistance		Higher than 50 MΩ under DC 500V megger during power terminal and FG terminal
Withstand voltage		1500V AC 50/60Hz for 1min across power terminal and PE terminal
Standard conditions	Ambient temperature	23 °C ± 2 °C (73.4 °F ± 2 °F)
	Ambient humidity	60 ± 5% RH
	Rated power supply voltage	100 to 240V AC
	Power supply Frequency	50 ± 1Hz or 60 ± 1HZ
	Vibration resistance	0 m/s ²
Operating Conditions	Ambient temperature range	0 to 50°C
	Ambient humidity range	10 to 90%RH (non-condensing)
	Rated power supply voltage	100 to 240V AC
	Allowable power supply voltage	85 to 264V AC
	Power supply frequency	50 ± 2Hz or 60 ± 2Hz
	Vibration resistance	0 to 1.96m/s ² (10 to 60Hz in X, Y, Z directions for 2 hours each)
Transportation and storage conditions	Ambient temperature range	-20 °C to +70 °C(-4 °F to +158 °F)
	Ambient humidity range	10 to 95% RH (non-condensing)
	Vibration resistance	0 to 1.96m/s ² (10 to 60Hz in X, Y, Z directions for 2 hours each)
Exterior		Case and front panel : plastic
Mounting		Panel-mount
Exterior size (unit: $\frac{mm}{inch}$)		$\frac{196}{7.717}(W) \times \frac{131}{5.157}(H) \times \frac{154}{6.063}(D)$
Panel cutout (unit: $\frac{mm}{inch}$)		$\frac{185.5 \pm 0.5}{7.303 \pm 0.02}(W) \times \frac{120.5 \pm 0.5}{4.744 \pm 0.02}(H)$

Items		Specification
Display and setting section	Display	5.7" LCD (STN Negative, BLUE), LED backlight
	Screen size (unit: $\frac{mm}{inch}$)	$\frac{115.17}{4.534}(W) \times \frac{86.37}{3.4}(H)$
	The number of dot	320(W) X 240 (H) dots
	Back light	LED, White (Luminous Intensity: 20 cd/m ²)
	Display size	40 lines X 30 lines (case of 8X8 dot characters)
	Display color	Blue characters on a white ground
	Display language	Korean/English/Chinese (Conversion to Korean/English/Chinese selection screen at the Menu screen)
	Operation	Analog touch panel (Actuation force: 10g~80g)

- Input/output specifications

Items		Specification
Analog input	Number of inputs	2 (Universal input)
	Type	TC: K, J, R, S, B, E, T, N, W, C (JIS/IEC) RTD: Pt100 (JIS/IEC), JPt100 (JIS) Linear: VOLTAGE 0~10V, 0~5V, 1~5V CURRENT 0 ~ 20mA, 4 ~ 20mA For detail, refer to Table 2.6.1
	Sampling cycle	100 ms/channel
	Indication Accuracy	$\pm 0.1\%FS \pm 1$ digit (Accuracy is variable according to input type or range.)
	Cold junction accuracy	± 1.0 °C (± 1.8 °F) (under standard conditions)
	Input bias	-99.9 ~ +99.9 variable
	Digital filter	0 ~ 120 sec (0: filter off)
	Square-root Extraction	Low-cutoff: 0.1~5.0% of input (in case of voltage input from orifice or pressure sensor)
	Compensation	Linearity / Approximation (1)Segment breakpoint: 1 to 10 of total range (2)Compensation: -50.0~105.0% of CH1/2 PV input range (3)Bias Linearity : -50.0~105.0% of CH1/2 PV input range span Approximation: -50.0~105.0% of CH1/2 PV input range
External switch input	Input count	12 points
	Connectable output type	No-Voltage contact (relay contact) and Open collector (sink current toward 0V)
	Allocation (Fixed)	RUN/STOP, ADV, HOLD, Channel selection, Trouble inputs, Program number (or detail, refer to Table 2.6.2)
	Sampling cycle	100 ms
	Trouble messages	32 items

Items		Specification			
Event output	Open collector output	External supply voltage	MAX 30Vdc		
		Max. load current	MAX 100mA per channel		
	Time event	Output	Open collector x 12 (variable)		
		Event mode	3 types can be selected (depending on number 0, 1 and 2 input) only for Program segment. 0: OFF, 1: ON, 2: ON/OFF time setting		
Event output	PV events	Output points	Open collector output ON/OFF x 12 (Changeable) (MAX DC30V MAX 100mA / 1ch internal resistance 47Ω)		
		Event mode	According to number of 11 ~ 38		
		Operation channel	Loop1 /Loop2		
		Target value	Set Point (SP) / Present value (PV) / Target value (DV) / Manipulated value(MV)		
		Operating point	Absolute value (ABS) / Deviation (DEV)		
		Output operation	ZONE ON/OFF / Operation direction (LOW/HIGH)		
		Operation Range		Loop1	Loop2
			Absolute value	-19999.0 ~ 20000.0	-19999.0 ~ 20000.0
			Deviation value	-99.9 ~ +99.9	-99.9 ~ +99.9
			Operational point	± 0.0 ~ ± 100.0	± 0.0 ~ ± 100.0
On delay time	0 ~ 99 seconds				
Event output	Mode event	Output type	STOP,RUN,READY,END,TRBL,HOLD,WAIT, TUNE,MAN,FIX,DOWN,UP		
		Event mode	According to number of 41~60		
		Output points	Open collector output ON/OFF x 12 (Changeable) (MAX DC30V MAX 100mA / 1ch internal resistance 47Ω)		
		Target	Loop 1 /Loop 2 /BOTH		
		Condition	OR: When Loop 1 or Loop 2 is occurred , output AND: When Loop 1 and Loop 2 are occurred, output		

Items		Specification	
Event output	Alarm event	Output type	<u>INNER</u> : Set Point (SP) / Present value (PV) / Target value (DV) / Manipulated value(MV) ABS/DEV, Operation direction(LOW/HIGH) <u>DIAGNOSIS</u> : PV input burn-out <u>FAIL</u> : Instrument fail (Type : Memory, Power)
		Event mode	According to number of 61 ~ 80
		Operation	RUN : Operation in RUN mode ALL : Operation in all cases
		Output points	Open collector output ON/OFF x 12 (Changeable) (MAX DC 30V MAX 100mA / 1ch internal resistance 47Ω)
Auxiliary output (Option)	Type	Aux. Output 1	PV1, SP1, MV1, PV2, SP2, MV2, DEV1, 2
		Aux. Output 2	PV1, SP1, MV1, PV2, SP2, MV2, DEV1, 2
	Scaling	Variable	
	Output signals	4 ~ 20mA DC	
	Output accuracy	+/- 0.1% of span	
	Output update cycle	100 ms	

- Program specifications

	Items	Specification
Program section	No. of programs	100 programs (0 ~ 99)
	No. of segments	100 segments/1 program, or total 2000 segments
	Segment setting system	Segment time: Set by set points (SP) and time (Max. 99hours59min or 99min59sec) Segment Ramp-unit: Soaking-segment ramp rate (hr.min/min.sec) Ascending/descending ramp (Slope per hour/min) * Time unit is switchable
	PID group setting	Using segment PID Using zone PID: According to PV According to SP Group No.: 1 to 8
	WAIT function (Guarantee Soak)	Type (Front, rear, all) and WAIT zone and WAIT time
	Repeat	1 pattern all repeat x 1 (Maximum repeat is 999 cycle) Part repeat x 5 (Maximum repeat is 999 cycle)
	PV Start	Starting Target Set Point (SSP1 or SSP2) Starting with PV data point: Program operation starts with the PV data at the time of starting and advances toward the target Set Point of segment-1 for both PV1 and PV2 programs
	Event setup	TIME and PV events setup are available. Max 2000 items.
	Program link	Maximum 6 programs Link program registration: Maximum 10 links
	Program name	100 programs (Each pattern can have its name), Max. 12 characters
	POWER FAILURE	Controls right away after recovery of power failure, if the power failure lasts less than 5 seconds. For power failure that lasts longer than 5 seconds, setup modes below will be followed. <u>BREAK</u> : Stops program <u>HOT START</u> : Controls at the state just before power failure <u>COLD START</u> : It starts again at the beginning of program (Note) It is HOT START for fix control

- Control output specifications

Items		Specification		
Control Section	PID control	Algorithm	PID-A / PID-B / DUP-A / DUP-B	
		Proportional band (P)	Proportional Band: 0.1 ~ 9999% GAIN: 0.001 ~ 1000	
		Integral time (I)	0.00 ~ 10.00 RPT/MIN	
		Derivative time (D)	0.02 ~ 50.00 RPT/MIN	
		Manipulated variable limit (MV)	Low-limit: -5.0 to High-limit % High-limit: Low-limit to +105.0%	
		Manual reset	-100 to +100	
		No. of PID groups	Loop 1: 8 groups Loop 2: 8 groups	
		PID groups selection	Segment specified, automatic zone selectable during program run	
		Auto tuning	Accutune II: Automatic setting of PID value by limit cycle method.	
		Fuzzy Control function	Fuzzy Control function	
		On-off control differential	0 ~ 1000	
	Control direction	Selection is settable (Reverse/Direct) HEAT/COOL is settable each channel		
Operation mode	Auto/Manual operation is switchable *Manual output : i) Bumpless ii) Preset value : -5.0~105.0%			
Control output section	Output set	TYPE	Current, Voltage Pulse, Relay	
	Current output	Output signals	4~20mA DC	
		Output accuracy	+/-0.1% of span	
		Output update cycle	100 msec	
	Voltage output	Open time terminal voltage	Lower than 15V DC (20mA)	
		Time proportional cycle	1 ~ 240 sec	
	Relay contact Output	Output signal	NC, NO, and common terminals (SPDT)	
		Contact rating	250VAC, 3A or 30VDC, 3A (Resistance load)	
	Open Collector	External Supply Voltage	MAX DC30V	
		Max. Load Current	MAX 100mA/1ch	

- Control mode

Items		Specification
Mode	Program run mode	READY: It ready until scheduled time (Control stop) RUN: Advancing run state HOLD: Hold run state WAIT: Wait run state END: End point run state (Control stop) BREAK: POWER FAILURE mode and Stop state(Control stop) TUNE: AUTO-TUNING state
		QUICK: Start by RUN/STOP key or contact relay input TIMER: Start by scheduled time
	Fix control mode	READY: It ready until scheduled time(Control stop) RUN: Advancing run state HOLD: Hold run state TUNE: AUTO-TUNING state
		QUICK: Start by RUN/STOP key or contact relay input TIMER: Start by scheduled time

- Communication specifications

Items		Specification		
Communication	RS232 (Basic)	Speed	9600 or 19200	
		Parity check	NONE	
		Bit length	8	
		Stop Bits	1	
	ModBus (Option)	Number of data bits per character	Bit transfer order	LSB first
			End of message	Idle line for three or more characters (>1.56 msec).
	Ethernet (Option)	Protocol	ModBus / TCP protocol	
		Port	One 10BaseT(RJ-45 connector)	
		Cabling type	UTP category 2 or better Note) UTP: Unshielded Twisted Pair cable	

5. Model Number Interpretation

Instruction

- Select the desired key number
- Make the desired selections from Table I through Table III. A dot (•) denotes the availability

Key Number Table I Table II Table III
IPC5000 - - -

KEY NUMBER

Description		Selection	Availability	
Control Loop	Single Loop Control	IPC5000S	↓	
	Dual Loops Control	IPC5000D		↓

TABLE I - Input & Outputs

Input	Standard Input (1 AI(S) / 2 AIs(D) + 12 Digital Inputs)	0 _	•	•
	Standard Input + 1 Analog Input	1 _		
Output	Standard Output (2 Analog Outputs + 14 Digital Outputs)	_ 0	•	•
	Standard Output + 2 Analog Outputs	_ 1		•

TABLE II - Options

Communication	RS-232C	0 _	•	•
	RS-232C, RS-485 (Modbus RTU)	1 _	•	•
	RS-232C, Ethernet (Modbus TCP)	2 _	•	•
	RS-232C, RS-485 (Modbus RTU), Ethernet (Modbus TCP)	3 _	•	•
Manual CD & Cable	Manual CD	_ 0	•	•
	Manual CD with RS-232C Cable	_ 1	•	•

TABLE III - Language

Display Language	English/Korean	0	•	•
------------------	----------------	---	---	---

ORDERING INSTRUCTIONS

1. Orders may be placed only by model selection (not by part number)
2. Orders placed by model selection are systematically protected against incompatibility.

* Analog Input (option) may be selected only in case its functional purpose is specified.
 Please, contact the factory to check the price for its customization

HONEYWELL ASIA PACIFIC AFFILIATES

Australia

Honeywell Limited
5 Thomas Holt Drive
North Ryde NSW 2113
Phone: (61) 2-9370-4500
Fax: (61) 2-9370-4525
Toll Free: 1300-36-39-36
Toll Free Fax: 1300-36-04-70
e-mail: salomon.avach@honeywell.com
Web: www.honeywell.com.au

China – PRC – Beijing

Honeywell China Inc.
15F Han Wei Plaza, East Tower
No.7 Guang Hua Road
Choyang District
Beijing 100020, P.R.C.
Phone: (86) 10 6561-0208 Ext. 205
Fax: (86) 10 6561 0618
e-mail: jn.qui.wang@honeywell.com

China – PRC – Shanghai

Honeywell (Tianjin) Ltd.
23F Tower B City Center,
100 Zun Yi Road,
Shanghai 200051, P.R.C.
Phone: (86) 21 6237-0237 Ext. 305
Fax: (86) 21 6236 1237
e-mail: jing.sheng.qiao@honeywell.com

China – Hong Kong S.A.R

Honeywell Ltd.
25F Honeywell Tower Olympia Plaza
255 King's Road
North Point, HongKong
Phone: (852) 2331-9133
Fax: (852) 2331-9998
e-mail: wilson.chow@honeywell.com

China – PRC – Shenzhen

Honeywell China Inc.
Units 04-07, 32F Shenzhen Kerry Center
Renminnan Road, Luo Hu District
Shenzhen 518001, P.R.C.
Phone: (86) 755-518-1226
Fax: (86) 755-518-1221
e-mail: robin.tu@honeywell.com

Indonesia

Honeywell Indonesia Pte Ltd.
Wisma Budi, #405 4th Floor
H.R. Rasuna Said Kav C-6
Jakarta 12940, Indonesia
Phone: (6221) 521-3330
Fax: (6221) 521-3735
e-mail: ariantowibowo@honeywell.com

India

TATA Honeywell Ltd.
55A 8&9
Hadapsar Industrial Estate
Pune 411013, India
Phone: (91) 20 6875-532
Fax: (91) 20 6875-535
e-mail: ashutoshd@tatahoneywell.co.in

Japan

Honeywell Inc. Sensing&Control
TF B/D 14-6 Shibaura 1-Chome
Minato Ku Tokyo 105-0023 Japan
Phone: (81) 3 5440-1425
Fax: (81) 3 5440-1368
e-mail: tetsuo.shinno@honeywell.com

South Korea

Honeywell Korea Co. Ltd.
18F KukJe Center B/D
191 HanGangRo-2Ga
YongSan-Gu, Seoul, 140-702, Korea
Phone: (82) 2 799-6176
Fax: (82) 2 792-9013
e-mail: byeongdeok.choi@honeywell.com
Web: www.honeywell.co.kr

Malaysia

Honeywell Engineering Sdn Bhd
2F Wisma CSA
No.4 Jalan Bersatu 13/4
46200 Petaling Jaya
Selangor Darul Ehsan
Phone: (603) 7950 4759
Fax: (603) 7958 8922
e-mail: ks.yong@honeywell.com

New Zealand

Honeywell Limited
264 Mt. Eden Road
Mt. Eden Auckland
New Zealand
Phone: (64) 9 623-5050
Fax: (64) 9 623-5060
Toll Free: 0800 202-088
e-mail:
ProductCustomerService@honeywell.com.au

Philippines

Honeywell Systems (Philippines) Inc.
E-1507A, 15F Tektite Tower 1
Exchange Road, Ortigas Center
Pasig City 1605, Philippines
Phone: (63) 2 636 1649
Fax: (63) 2 636 1650
e-mail: melchor.nicolas@honeywell.com

Sensing&Control

Asia Pacific Headquarters
Honeywell Building
17 Changi Business Park, Central 1
Singapore 486073
Phone: (65) 355-2828
Fax: (65) 445-3033
Web: www.honeywell.com/sensing
e-mail: info.sc@honeywell.com

Singapore

Honeywell South East Asia
Honeywell Private Limited
Honeywell B/D
17 Changi Business Park, Central 1
Singapore 486073
Phone: (65) 355-2828
Fax: (65) 445-3033
Web: www.honeywell.com/sensing
e-mail: info.sc@honeywell.com

Thailand

Honeywell Systems (Thailand) Ltd.
252/121
25F Muang Thai-Phatra Office Tower II
Ratchadapisek Road, Huay Khwang
Bangkok 10320, Thailand
Phone: (662) 693-3099
Fax: (662) 693-3085
e-mail:
somboon.rungjaraspan@honeywell.com

Taiwan R.O.C.

Honeywell Taiwan Ltd.
10F Honeywell B/D
168-1 Lien Chen Road, Chung Ho City
Taipei Hsien, Taiwan R.O.C.
Phone: (886) 2 2245-1000
Fax: (886) 2 2245-3242
e-mail: steven.chi@honeywell.com

For Countries (SEAsia) Listed below,

See Honeywell SEAsia Regional Office
Bangladesh
Cambodia
Guam
Laos
Myanmar
Nepal
Pakistan
Sri Lanka
Vietnam
East Timor

Industrial Measurement & Control

Honeywell Pte LTD
Honeywell Building
17 Changi Business Park Central 1
Singapore
<http://www.honeywell.com>

Honeywell