

System Overview

CALogix is a modular multi-loop PID controller with logic function capability. The controller consists of a DIN-rail mount base-unit that incorporates power supply, RS485 communications ports and slots for up to 4 control modules. The control modules are available as PID or Logic I/O and can be selected then mounted into the base-unit as required for the application. Variations in PID control modules include temperature sensor and linear (0-50mV, 4-20mA, 0-5V & 0-10V) inputs with options for relay, ssd or analog (4-20mA, 0-5V & 0-10V) outputs. Logic I/O modules have user defined 0-5, 0-10, 0-24Vdc inputs with relay or ssd outputs. All wiring connectors to the base unit and control modules are plug-in to reduce installation and maintenance times.

CALogix is configured using the Windows™ based CALogix-sw configuration tool which is provided with each base-unit. PID setup, input & output parameter settings, profile creation and writing logic function block diagrams can all be performed within the software utility. These settings can be read, modified and written to and from the controller and also saved on the PC as a file to be recalled at a later date when required. The program also provides information on current process value, set-points and output status which can be useful when commissioning the system.

Mechanical Installation

The controller is designed as two main components

BASE-UNIT

DIN rail mount device containing main CPU and connections for up to 4 control modules.

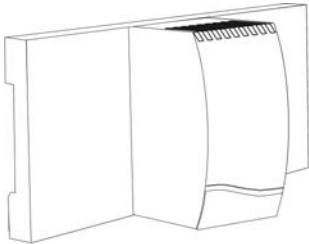

CONTROL MODULE

PID or Logic control modules can be mixed as required for the application and plugged in to base-unit.



1 base-unit and 1-4 control modules must be used for operation of product. A CALogix system can only be configured using CALogix-sw pc-based software.

MOUNTING

To mount a base unit with control modules proceed as follows:

1. Affix 35mm type DIN rail securely to mounting surface, minimum length 140mm. The unit should be mounted vertically as shown.
2. Attach carrier unit to DIN rail ensuring the spring release is at the bottom, facing downward.

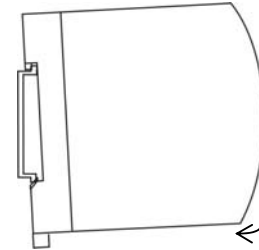

3. Ensuring the input terminals are facing downwards, add the control modules to base unit. Press the top and bottom tabs on the module lightly and ensuring module is kept straight, push to locate in base unit (see diagram below).

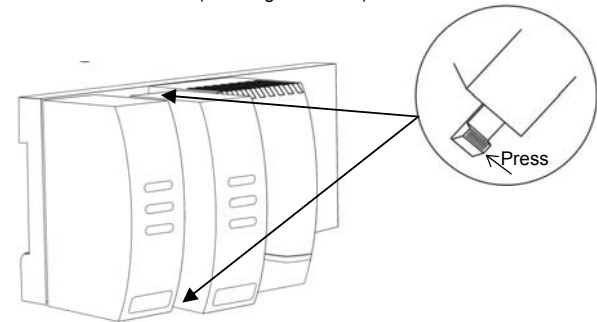

4. Pre-wire connectors and plug into the appropriate modules (we suggest wire markers for identification)

REMOVING A MODULE



1. Isolate supply to CALogix and all module input and output connectors.
2. Unplug connectors to module requiring removal.
3. Press tabs as shown above to release module.
4. Carefully pull the module away from base-unit ensuring tabs are free to remove.

REMOVING BASE-UNIT FROM DIN-RAIL

- 1. Isolate supply to CALogix and all module input and output connectors.
- 2. Unplug connectors to base-unit and all modules.
- 3. Insert screwdriver into DIN-rail release block and apply pressure away from the controller, the base-unit can then be removed.

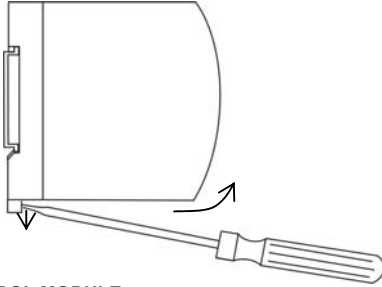

REPLACING A CONTROL MODULE

When replacing a control module follow the instructions above for removing and installing control modules. If a control module is being replaced with another that has the same part number, all parameter settings will be automatically transferred from the base unit to the new module on re-powering the system, no reconfiguration will be required.

- ! If a module is being replaced with a module that has a different part number, ensure that the system is re-wired accordingly and the module settings are modified to reflect the changes made, before running your system. Failure to do so may result in dangerous operation or damage to the system.

If you are replacing logic modules with PID modules, it is important to turn off or delete any associated logic.

CLEANING

Wipe down with damp cloth (water only).

DIMENSIONS

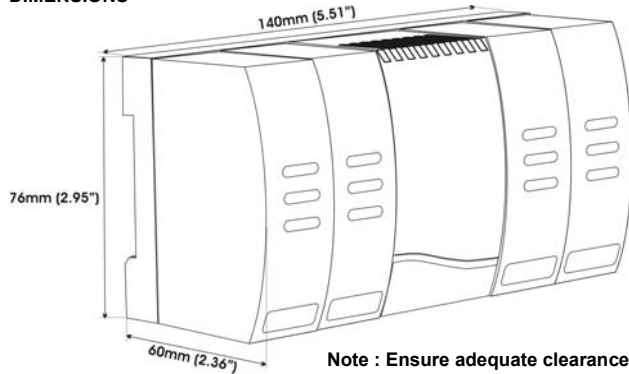

Note : Ensure adequate clearance for connectors and wiring

Electrical Installation

- ⚡ The system is designed to be installed in an enclosure which provides adequate protection against electrical shock. The enclosure should also be of a sufficient IP (NEMA) rating for protection against water and dust.

OUTPUT DEVICES

Three types of output are available on a module: relay, solid state relay drive (ssd) and analog. Output 1 may be any one of the three options, output 2 can be relay or ssd and output 3 is always relay. Any of these outputs can be assigned as SP1, SP2 and SP3 using the CALogix-sw software. Check the model number and output configuration before wiring the instrument and applying power. See section on **output options** for more details.

1. **Solid state relay drive**
12Vdc +10/-15% (nominal), 20mA
To switch remote SSR
2. **Miniature power relay**
2A/250Vac resistive, Form A/SPST contacts
3. **Analog Output (Isolated) - NOT AVAILABLE WITH LOGIC I/O MODULE**
Specify 4-20mA 500Ω max. ±0.1% fs typical
0-5Vdc 10mA (500Ω min). ±0.1% fs typical
0-10Vdc 10mA (1KΩ min). ±0.1% fs typical

- ⚡ **SUPPLY VOLTAGE**
18-30Vdc, 8 watts ±10% fluctuation permitted

WIRING THE CONNECTOR

Prepare the cable carefully, remove between 6 and 8mm insulation and ideally tin or terminate to avoid bridging. Prevent excessive cable strain. Maximum recommended wire size 32/0.2mm 1.0mm² (18 AWG)

- ⚡ **REPLACING MODULES**
Hot-plugging of modules should not be carried out. To change a module always de-power the base-unit. Once power is re-applied the carrier will reload the settings for that module and continue with the original module settings. Hot-plugging can cause the carrier to fail and is potentially dangerous.

INDUCTIVE LOADS

To prolong relay contact life and suppress interference, it is recommended engineering practice to fit a snubber (0.1µF/100Ω) between relay output terminals.

CAUTION
Snubber leakage current can cause some electro-mechanical devices to be held ON. Check with manufacturers specification.

EN61010 - 1 / UL61010C-1/ CSA22.2 No 1010

Compliance shall not be impaired when fitted to the final installation. Designed to offer a minimum of basic insulation only.

- The body responsible for the installation is to ensure suitable for measurement category II or III
- To avoid possible hazards, accessible conductive parts of the installation should be protectively earthed in accordance with EN61010 for Class 1 equipment.

- Output wiring should be within a protectively earthed cabinet.
- Sensor sheaths should be bonded to protective earth or not be accessible
- Live parts should not be accessible without the use of a tool.

EMC GUIDELINES

We make a number of general recommendations that can reduce the possibility of EMC problems.

- 1) It is important to suppress CALogix relay contacts, this will reduce switching interference and also prolongs life of the contacts.

RC Networks fitted across the relay contacts are recommended for resistive and larger inductive loads, values such as 0.1µF capacitor in series with a 100Ω resistor.

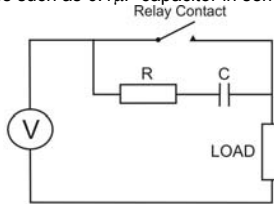

For small inductive loads, a suitable rated VDR is recommended.

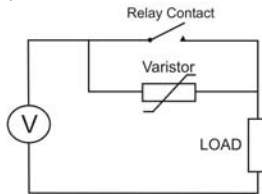

For small inductive dc loads, relays etc, a suitably rated diode fitted in parallel with the load is recommended.

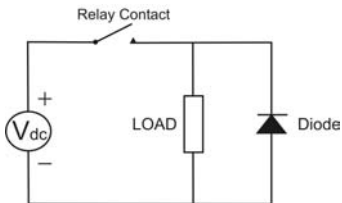

- 2) CALogix should be mounted into a metal cabinet which is properly earthed, good all round metal shielding is important.
- 3) It should be borne in mind that the wiring of the installation can significantly reduce the efficiency of the instrumentation immunity. This is due to the ease with which high frequency RF can enter via unprotected incoming and outgoing cables. Earthed thermocouples or sensors with screened cable, should be earthed at the cabinet entry point.

Any long cables entering the control cabinet should be protected at the point where they enter the cabinet, large diameter ferrite sleeves are an economical and effective method of reducing high frequency RF, looping the cables through ferrite sleeves a number of times will improve the efficiency of the filtering.

Alternatively for mains cables, the fitting of a suitable mains filter can provide good results.

Data or communications cables should be screened. If using Belden 8132 connect drain wire to PIN 5 of a shielded RJ45 connector.

Ideally data and sensor cables should be routed separately from power cables and away from inverters or other high power/frequency devices.

SUPPLY AND RS485 COMMUNICATIONS CONNECTIONS

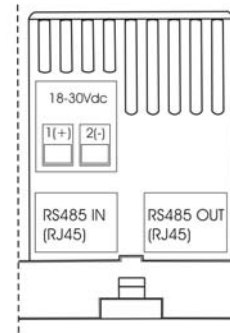

INPUT OPTIONS

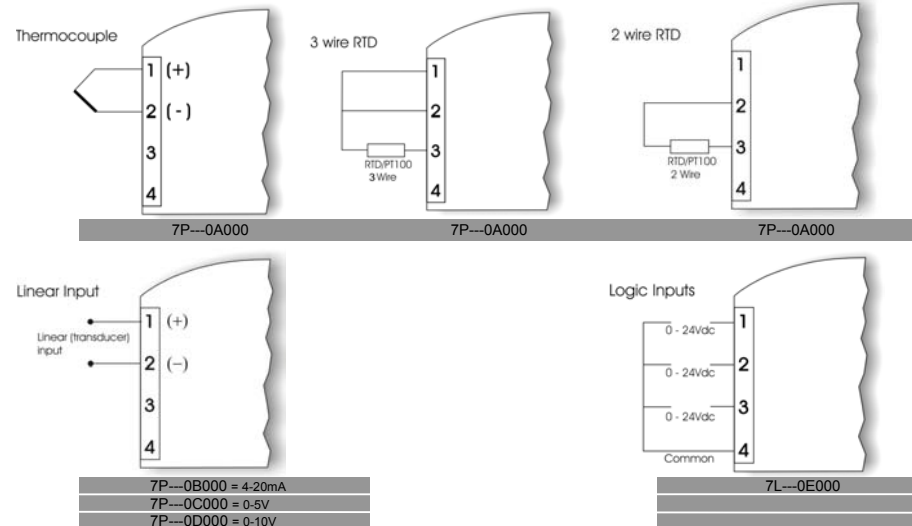

OUTPUT OPTIONS

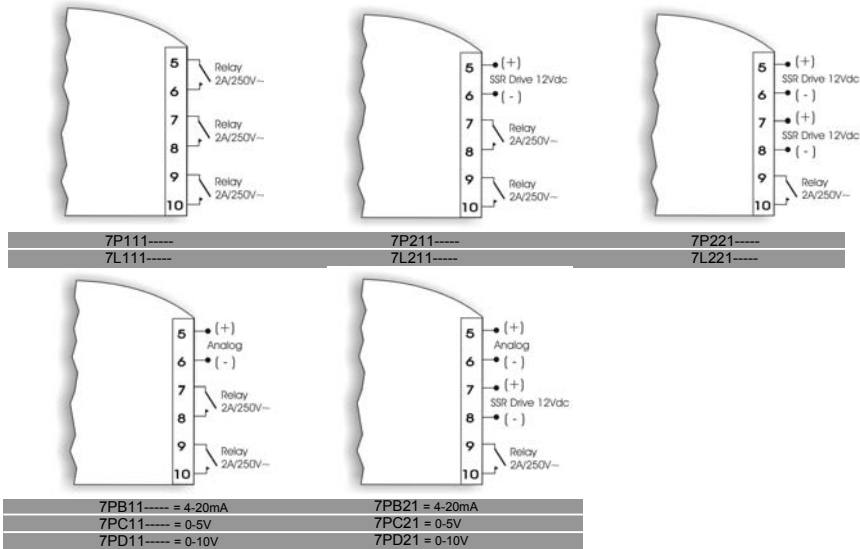

EXAMPLE CIRCUIT

The circuit below shows an example application which includes a base-unit that has one PID module and one logic module fitted.

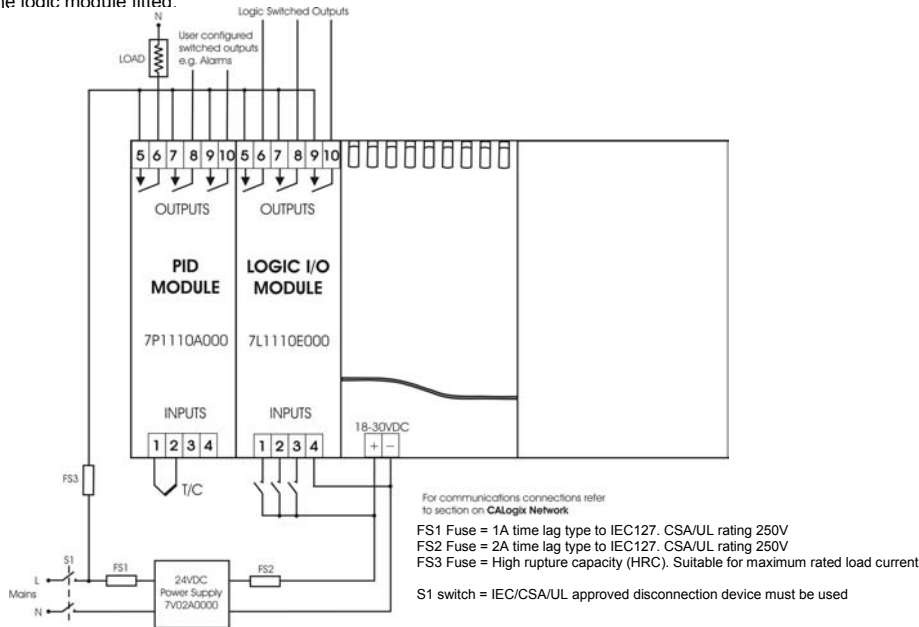

It is strongly recommended that the power supply zero volts and all logic module zero volts are common to prevent ground loops.

INPUT SENSOR SELECTION

Thermocouple type	Description	Sensor Range (°C)	Sensor Range (°F)
B	Pt-30% Rh/Pt-6%Rh	0 to 1800°C*	32 to 3272°F*
E	Chromel/Con	0 to 600°C	32 to 1112°F
J	Iron/Constantan	0 to 800°C	32 to 1472°F
K	Chromel/Alumel	-50 to 1200°C	-58 to 2192°F
L	Fe/Konst	0 to 800°C	32 to 1472°F
N	Nicrosil/NiSil	-50 to 1200°C	-58 to 2192°F
R	Pt-13%Rh/Pt	0 to 1600°C	32 to 2192°F
S	Pt10%Rh/Pt	0 to 1600°C	32 to 2192°F
T	Copper/Con	-200 to 250°C	-273 to 482°F
Resistance Thermometer rtd 2/3 wire	Pt100/RTD-2/3	-200 to 800°C	-273 to 1472°F

* Note : Type-B accuracy not specified below 100°C/212°F

Configuring and Networking CALogix

CALogix is configured using Windows-based CALogix-sw software. Before using CALogix-sw, connect CALogix to a PC as shown below:

CALOGIX NETWORK

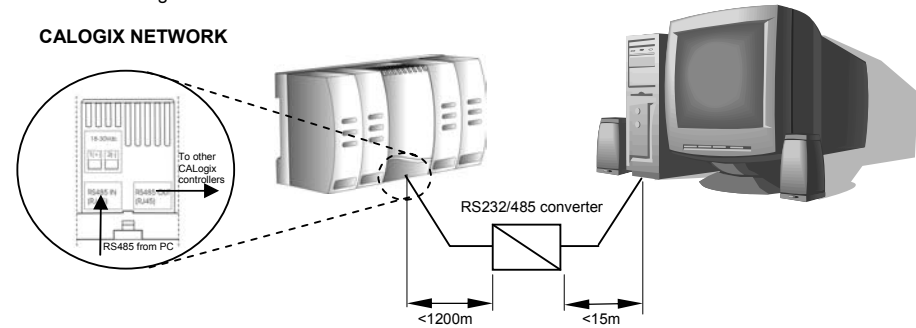

CALogix uses RS485 full duplex serial communications link which is the standard most commonly used for industrial applications due to high noise immunity and multi-drop capability. It enables a PC to communicate with up to 31 CALogix base-units over distances up to 1200 metres, and requires the addition of an RS485 interface card, or a separate RS232 / 485 converter connected to the RS232 port of the PC. RS485 converters that derive power from the RS232 port must have all 9 pins (RS232) connected for full operation of the converter.

RS485 cards and converters can differ greatly in their requirements and therefore the installation instructions supplied with the interface should be read carefully.

2m CALogix-PC cable (part number - CAB RJ45 2M 01) and a RS232/485 converter (part number - 3C 25 000 K 3X) that fits directly on to the RS232 serial port on a PC are available from your nearest CAL Controls distributor.

If wiring your own cable the RS485 connections are as follows.

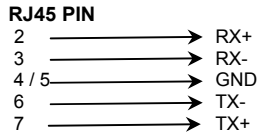

As CALogix is designed for an industrial environment, CAL recommends using a 4 wire shielded RS485 cable such as Belden 8132. Ensure that connectors are suitable for use with shielded cable and are correctly bonded.

Auto-baud rate function. On power up CALogix detects the network speed and automatically adjusts its baud rate accordingly. If the network baud rate is later modified, remove the power and reapply so that CALogix can resynchronise to the new baud rate.

MULTIPLE CALOGIX NETWORKS

Each CALogix unit has an RS485-in and RS485-out RJ45 socket. To connect a number of CALogix units on a network, wire as shown below. The cables should be wired so that the corresponding pins of RS485-out are connected to the same pin number on RS485-in of the next controller i.e. Pin 2 (out) to Pin 2 (in), Pin 3 (out) to Pin 3(in), Pin 5(out) to Pin 5(in), Pin 6(out) to Pin 6(in) and Pin 7(out) to Pin 7(in).

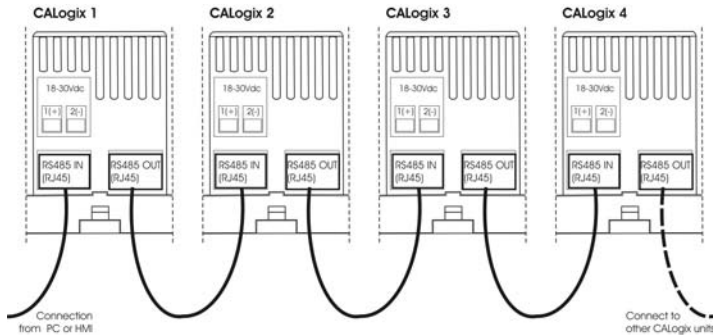

For multiple instrument networks each transmission line must be properly terminated to prevent reflections. 120Ω termination resistors should be fitted between TX+ & TX- and RX+ & RX- at the connection to the PC in addition to the last instrument in the chain. See example below.

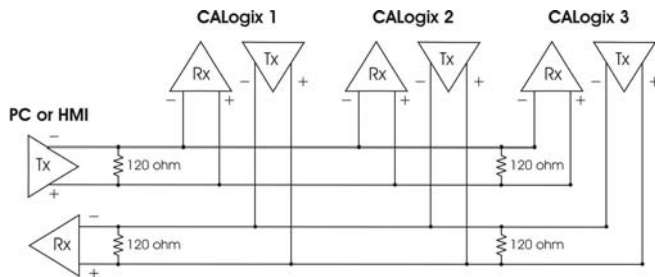

When transmission lines are not transmitting, they remain in an intermediate state which can allow receivers to receive invalid data bits due to electrical noise on the cable. To prevent this bias resistors may be required to force the lines into a known state. Some RS485 interface cards and converters may have bias resistors fitted please check manufacturer's specification and recommendations for use of bias resistors.

Note: The default Modbus address for each base-unit is 1, for a network with a number of CALogix units, power-up each unit individually and configure them with a unique Modbus address using CALogix-sw configuration tool. (See section on base-unit set-up in programming manual on cd)

CALOGIX-SW MINIMUM PC SYSTEM REQUIREMENTS

As a general requirement, we would recommend a minimum of Pentium 450MHz with 256MB RAM, Windows™ 2000/XP and screen resolution, 1024 x 768.

INSTALLING CALOGIX-SW

1. Insert CALogix-sw disk into CD-drive.
2. CALogix-sw install program should auto-run. If this does not happen, manually run 'setup.exe' on CALogix-sw cd.
3. Follow on screen instructions to complete installation.

RUNNING CALOGIX-SW

1. Click 'start' on Windows toolbar.
2. Mouse-over 'all programs'.
3. Mouse-over 'CALogix folder' in menu.
4. Click on 'CALogix' icon.
5. CALogix program should now run.

USING CALOGIX-SW

1. Refer to on-screen help or CALogix programming manual contained on CALogix-sw CD.

DIAGNOSTICS

Each control module has LEDs to indicate when each of the outputs are on (or relay closed). If an analogue output option is fitted the LED dims proportionately with the output level, e.g. a PID module with a 4-20mA output, the LED will be dim at 4mA and bright at 20mA.

Note: The output and the LED indicator are physically linked and always represent the true state of the output.

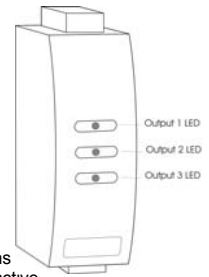

CALogix base-unit has three status LED's to assist with diagnosing problems

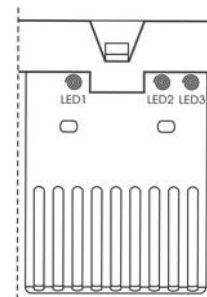

LED 1 – Communications

Off	No communications
On/Pulsing	Communications active

LED 2 – CALogix healthy (Heartbeat)

Slow pulse	Unit operating correctly
Fast Pulse	Base-unit emergency (comms still running)
On	Base-unit lock-up

When base-unit emergency/lock-up conditions exist recycle power to clear. If the problem is not clear on power recycle contact CAL controls for technical support.

LED 3 – Logic

Off	Logic not active
On	Logic active

To start logic program running refer to section on **running logic programs**

Specification

PID MODULE :

THERMOCOUPLE – 9 Types – B, E, J, K, L, N, R, S, T

Standards	IEC 584-1
CJC rejection	30:1 typical
External resistance	100Ω maximum

RESISTANCE THERMOMETER – 2 or 3 Wire

Standards	IEC 751 (100Ω 0°/138.5Ω 100°C Pt)
Bulb Current	0.2mA maximum

LINEAR PROCESS INPUTS

Linear Input	Typical Accuracy	Range
0-50mV	±0.1%	± 0.00 – 99.99, ±100.00 – 499.95, ±500 – 999.9, ±1000 – 9999
4-20mA	±0.1%	As above
0-5V	±0.1%	As above
0-10V	±0.1%	As above

APPLICABLE TO ALL INPUTS (SM = Sensor maximum, FS=Full scale)

Calibration Accuracy	±0.1% FS typical ±1°C
Sampling Frequency	Input 10Hz, CJC 4sec
Common mode rejection	Negligible effect up to 140dB, 240V, 50-60Hz
Temperature coefficient	50ppm/°C SM typical

OUTPUT DEVICES

Solid state relay driver : SSd1 and SSd2	12Vdc +10/-15% 20mA
Miniature power relay: Rly1, Rly2, Rly3	2A/250ac resistive load, form A/SPST
Analogue Output	4-20mA 500Ω max ±0.1% FS typical 0-5Vdc 10mA 500Ω min ±0.1% FS typical 0-10Vdc 10mA 1KΩ min ±0.1% FS typical

LOGIC I/O MODULE :

Input Range	0-5 / 0-10 / 0-24 Vdc (s/w select)
Outputs SSd1 and SSd2 Rly1, Rly2, Rly3	12Vdc +10/-15% 20mA 2A/250ac resistive load, form A/SPST
Maximum counter input frequency	1 fast 1KHz, Other 10Hz
Accuracy	±1%

ENVIRONMENTAL:

Safety	EN61010, UL and CSA approvals pending
Measurement	Categories II and III
Pollution	Degree II
EMC Emission	EN61000-6-3
EMC Immunity	EN61000-6-2
Mouldings	Flame retardant polycarbonate
Weight (including connectors)	Base unit – 170g, 6oz Control module – 90g, 3.2 oz
Ambient*	0 to 55°C
Humidity	90% max non-condensing
Altitude	Up to 2000m

SUPPLY:

Supply voltage	18-30Vdc, 8 watts ±10% fluctuation permitted
----------------	--

* Note : As with all electronic devices, product life is reduced at high ambient temperatures. Ensure that your control panel sufficiently cooled to maximise product life.

Safety and Warranty Information

Installation

EN6110-1 / UL61010C-1 / CSA 22.2 No 1010

To offer a minimum of basic insulation only
Suitable for measurement within category II and III and pollution degree 2

See Electrical installation

It is the responsibility of the installing engineer to ensure this equipment is installed as specified in this manual and is in compliance with appropriate wiring regulations.

Configuration

The controller can only be configured using CALogix-sw or CALgrafix software. It is the responsibility of the installing engineer to ensure that the configuration is safe.

Ultimate Safety Alarms

Do not use SP2/SP3 or logic module outputs as the sole alarm where personal injury or damage may be caused by equipment failure.

Warranty

CAL Controls warrant this product free from defect in workmanship and materials for three (3) years from data of purchase.

- Should the unit malfunction, return it to the factory. If defective it will be repaired or replaced at no charge.
- There are no user serviceable parts in this unit. The warranty is void if the unit shows evidence of being tampered with or subjected to excessive heat, moisture, corrosion or other misuse.
- Components which wear or damage with misuse are excluded e.g. relays.
- CAL Controls shall not be responsible for any damage or losses however caused, which may be experienced as a result of the installation or use of this product.

CAL Controls liability for any breach of this agreement shall not exceed the purchase price paid. E & O.E.

33086/01/0104



CAL Controls

CAL Controls Ltd

Bury Mead Road, Hitchin,
Herts, SG5 1RT, UK

Tel +44 (0) 1462 436161

Fax +44 (0) 1462 451801

e-mail sales@cal-controls.co.uk

www.cal-controls.com

CAL Controls Inc

1117 S. Milwaukee Av,
Libertyville, IL60048, USA

Tel (847) 680-7080

Fax (847) 816-6852

e-mail sales@cal-controls.com

www.cal-controls.com

**For help with your CALogix system, contact Lesman at
800-9LESMAN (that's 800-953-7626) or 800-837-1700.**