

SENACO CU 02

Instruction Manual PL-561

January 2001

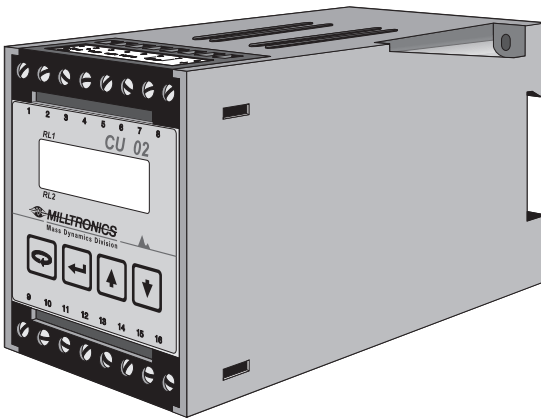

SENACO CU 02

Safety Guidelines

Warning notices must be observed to ensure personal safety as well as that of others, and to protect the product and the connected equipment. These warning notices are accompanied by a clarification of the level of caution to be observed.

Qualified Personnel

This device/system may only be set up and operated in conjunction with this manual. Qualified personnel are only authorized to install and operate this equipment in accordance with established safety practices and standards.

Warning: This product can only function properly and safely if it is correctly transported, stored, installed, set up, operated, and maintained.

Note: Always use product in accordance with specifications.

Copyright Siemens Milltronics Process Instruments Inc. 2000. All Rights Reserved

Disclaimer of Liability

This document is available in bound version and in electronic version. We encourage users to purchase authorized bound manuals, or to view electronic versions as designed and authored by Siemens Milltronics Process Instruments Inc. Siemens Milltronics Process Instruments Inc. will not be responsible for the contents of partial or whole reproductions of either bound or electronic versions.

While we have verified the contents of this manual for agreement with the instrumentation described, variations remain possible. Thus we cannot guarantee full agreement. The contents of this manual are regularly reviewed and corrections are included in subsequent editions. We welcome all suggestions for improvement.

Technical data subject to change.

MILLTRONICS® is a registered trademark of Siemens Milltronics Process Instruments Inc.

Contact SMPI Technical Publications at the following address:

Technical Publications
Siemens Milltronics Process Instruments Inc.
1954 Technology Drive, P.O. Box 4225
Peterborough, Ontario, Canada, K9J 7B1
Email: techpubs@milltronics.com

For the library of SMPI instruction manuals, visit our Web site: www.milltronics.com

About the Senaco CU 02

Note:

CU 02 is to be used only in the manner outlined in this instruction manual.

The Senaco Control Unit, CU 02, provides relay and analog outputs for interfacing a Senaco AS100 Sensor into a process.

Features

- ✓ LCD display
- ✓ 2 SPDT (form C) relays
- ✓ 4 - 20 mA output, isolated
- ✓ programmable start up delay
- ✓ programmable alarm delay

Specifications

- Power:
 - see nameplate for voltage configuration (100/115/200/230 V ac \pm 15%, 50/60 Hz, 10 VA)
- Environmental:
 - location:
 - indoor
 - altitude:
 - 2000 m max
 - ambient temperature:
 - -20 to 50 °C (-4 to 122 °F)
 - relative humidity:
 - 80% for temperatures up to 50 °C
 - installation category:
 - II
 - pollution degree:
 - 2
- Sensor Excitation:
 - 26 Vdc nominal, 70 mA max
- Input:
 - Senaco Sensor
 - 0 – 10 Vdc
- Display:
 - liquid crystal
 - three 9 mm (0.35") digits
 - multisegment graphic for operation status
- Relay:
 - 2 alarm/control relays
 - 1 form 'C' SPDT contact per relay, rated 5 A at 250 V ac non inductive
- Analog Output:
 - isolated 4 - 20 mA
 - 750 Ω load max
- Enclosure:
 - 55 mm W x 75 mm H x 110 mm D (2.2" W x 3" H x 4.4" D)
 - polycarbonate
 - mounting:
 - DIN rail (DIN 46277 or DIN EN50022)
 - wall / panel mount
- Ingress Protection:
 - IP 20
- Approval:
 - CSA general purpose
- Weight:
 - 550 g (18 oz)

Installation

Notes:

- Installation shall only be performed by qualified personnel and in accordance with local governing regulations.
- This product is susceptible to electrostatic shock. Follow proper grounding procedures.

Mounting

Dimensions

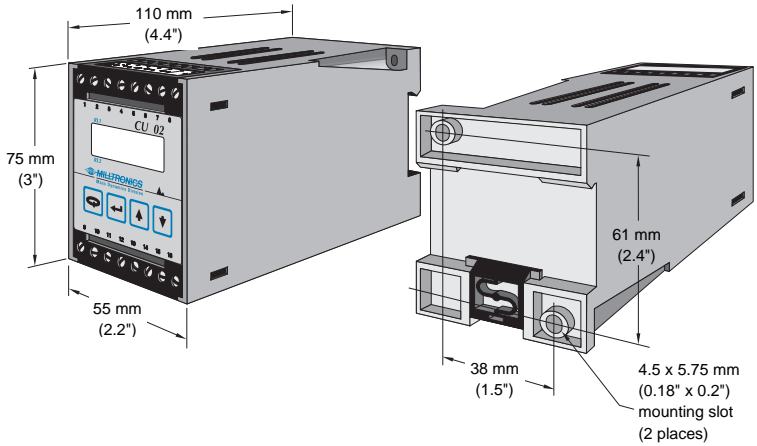

Wall / Panel Mounting

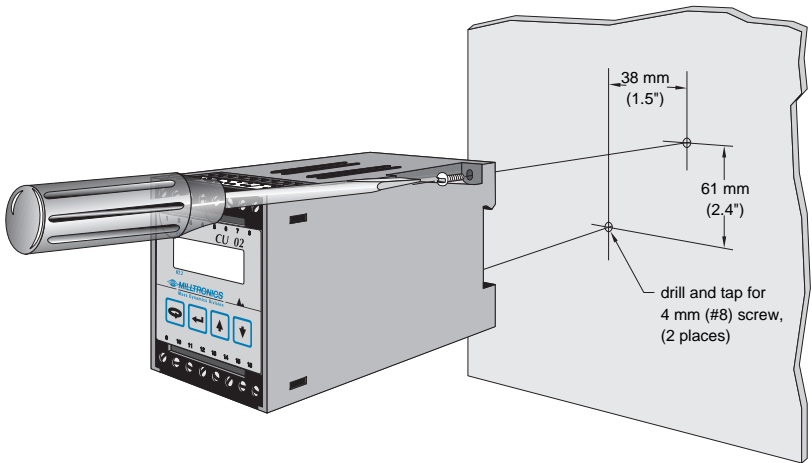

Rail Mounting

Mounting

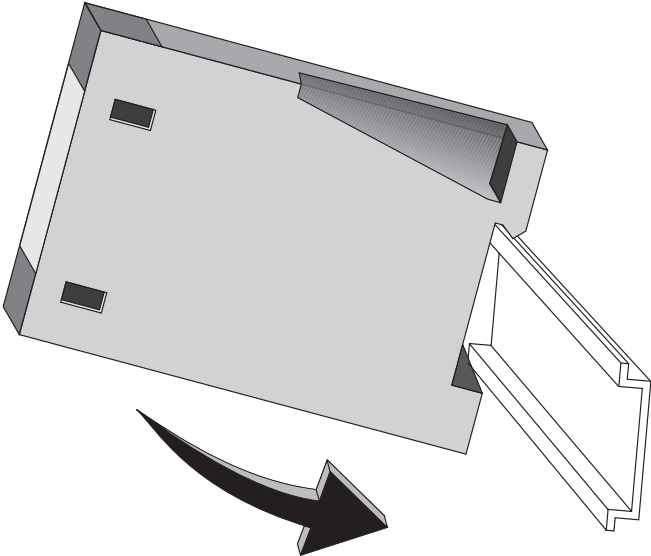

Removal

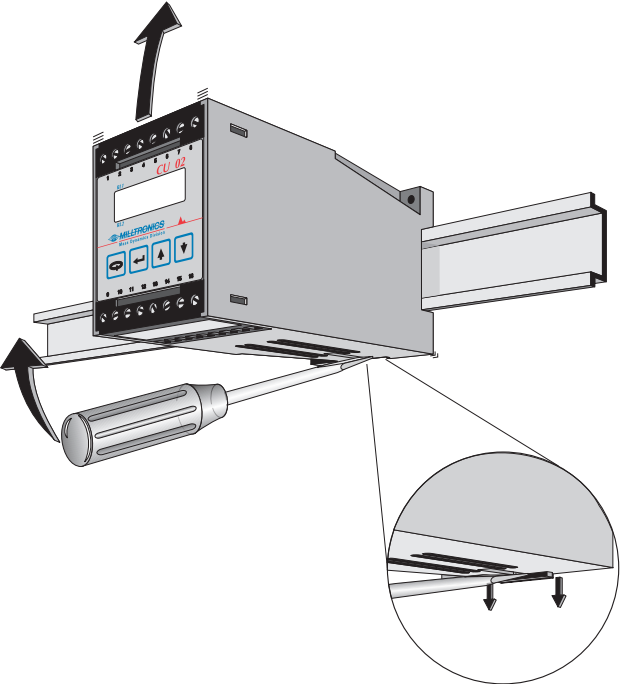

Interconnection

Connection Layout

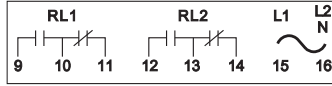
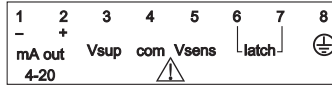

WARNING:

- All field wiring must have insulation suitable for at least 250V.
- Relay contact terminals are for use with equipment having no accessible live parts and wiring having insulation suitable for a least 250 V.
- The maximum allowable working voltage between adjacent relay contacts shall be 250 V.

Senaco AS100 Sensor Connection

Standard Temperature Version

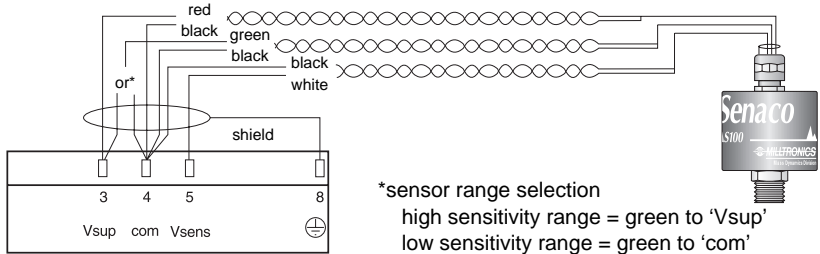

Extended Temperature Version

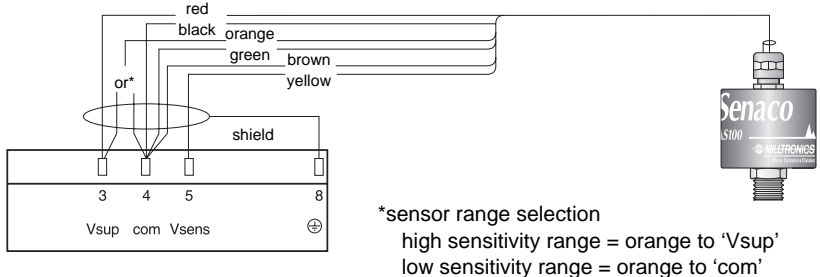

Relay Output Connection*

Auto Reset
($P14 / 24 = 0$)

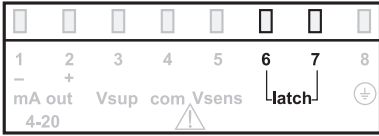

Manual Reset
($P14 / 24 = 1$)

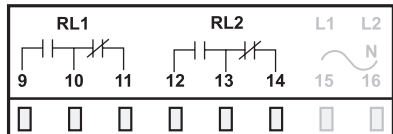
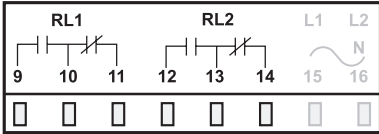
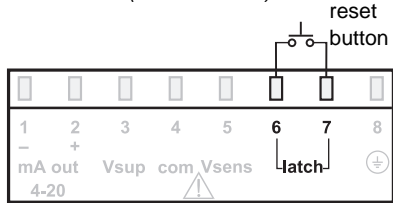

N.O. COM N.C. N.O. COM N.C.

N.O. COM N.C. N.O. COM N.C.

All relays are certified for use in equipment where the short circuit capacity of the circuits in which they are connected is limited by fuses having ratings not exceeding the rating of the relays.

*refer to Operation \ Alarm

Analog Output Connection

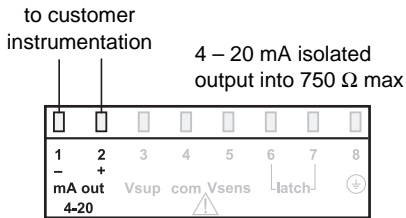

Power Connection

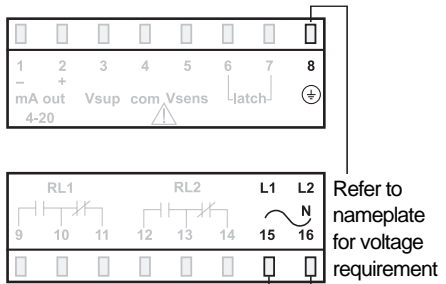

The equipment must be protected by a 15 A fuse or circuit breaker in the building installation.

A circuit breaker or switch in the building marked as the disconnect switch shall be in close proximity to the equipment and within easy reach of the operator

Operation

Start Delay

On initial powering of the CU 02, the start delay circuit prevents the relays from going into alarm for the period of time programmed (parameter P80).

Display

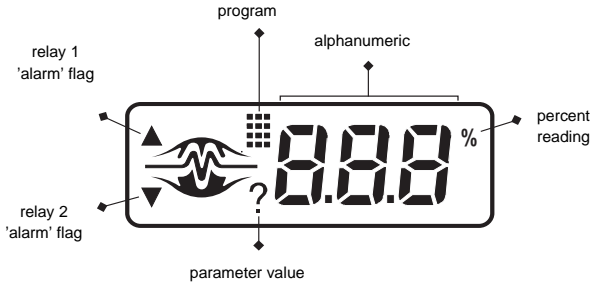

The CU 02 normally displays the input signal level (Vsens) from the Senaco sensor in volts, or in percentage of the programmed span (P3 – P2). The selection is made while viewing Vsens.

Press:  for percent

Press:  for volts



Damping is provided to slow the response of the display when rapid or minor fluctuations in the process or machinery operation are encountered. The greater the damping value (P86), the slower the response.

Relay

The CU 02 has two onboard programmable relays (P10/20). Under normal operation, the relays are energized (normally open contact closed). Under alarm condition, the `alarm' flag starts flashing immediately, indicating that the relay delay (P13/23) has started counting. If the alarm condition ceases before the relay delay expires, the flashing `alarm' flag is aborted. If the relay delay expires, the relay de-energizes and the contacts change state. The `alarm' flag ceases flashing and remains on. Upon resumption of normal operating condition, the `alarm' flag disappears. The relay and relay delay reset manually or automatically depending on the mode selected (P14/24). If

automatic, the reset is immediate. If manual, the reset occurs upon actuation of the reset button (latch).

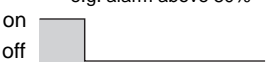
Each relay is programmable for either:

high alarm:	alarm condition occurs when the sensor signal level (%) is of a greater value than the high% setpoint	 <p>on off</p> <p>0 80 100</p> <p>e.g. alarm above 80%</p>
low alarm:	alarm condition occurs when the sensor signal level (%) is of a lesser value than the low% setpoint	 <p>on off</p> <p>0 20 100</p> <p>e.g. alarm below 20%</p>
out of bound	alarm condition occurs when the sensor signal level (%) is of a greater value than the high% alarm setpoint or of a lesser value than the low% alarm setpoint	 <p>on off</p> <p>0 20 80 100</p> <p>e.g. alarm beyond 20% and 80%</p>
in bound:	alarm condition occurs when the sensor signal level (%) is of a value between the low% and high% alarm setpoints	 <p>on off</p> <p>0 20 80 100</p> <p>e.g. alarm between 20% and 80%</p>

The individual relay functions in combination provide:

- high% and high-high% alarm
- high% and low% alarm
- high% and bound alarm
- low% and low-low% alarm
- low% and bound alarm
- bound 1 and bound 2 alarm

Note:

if the Senaco AS100 sensor is located in areas with high RF noise, then the alarm setpoints should be set to 0.50 V above or below the fault/no fault conditions

Analog Output

The CU 02 provides an isolated analog 4 - 20 mA output by calibration of the 4 and 20 mA levels to the operating span of the input signal (V_{sens}) from the Senaco sensor. In the case where V_{sens} passes the lower and upper limits of the span, low and high mA limits are factory set to nominal values of 2 and 22 mA respectively, providing indication of overrange activity.

Damping is provided to slow the response of the analog output when rapid or minor fluctuations in the process or machinery operation are encountered. The greater the damping value (P85), the slower the response.

Security

The CU 02 is factory shipped with security (P 1) disabled, allowing program access. If it is desired to deny programming access (viewing access is not restricted), security can be enabled by entering the enable code. If it is desired to regain programming access, the disable code must be entered. Refer to Security Alteration.

Parameter Reset



A master reset (P99) is provided to automatically reset all programming parameters to their factory values. However, if it is desired to reset an individual parameter, this can be done by entering its factory value, as given in Parameter List.

Setting Up



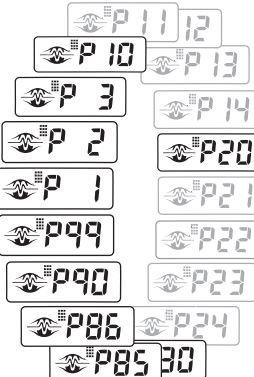

To Access Program:

Press	Display	
		run display
		program starts at parameter 1









To Select a Parameter:

	 		to scroll up or down to desired parameter
--	--	---	---

To View a Parameter Value:



			select parameter, e.g. P3
			display parameter value, e.g. 2.50
			exit

To Change a Parameter Value:



			select parameter, e.g. P3
			display parameter value, e.g. 2.50
	 	  	increase or decrease to the desired value If no response, security not disabled!

Security must be disabled!

Must be pressed to Save change!

		save and exit
---	---	---------------

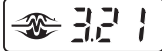

To Return to Run Display:

			from the parameter display, e.g. P 3
		exit program and return to run display	

Operating Values

With the Senaco Sensor and Control Unit properly mounted, connected and powered. Run the material or machinery through its range of operation.

Note the following values where applicable:

- normal operating level $V_{\text{norm}} = \underline{\hspace{2cm}}$ 
- abnormal operating level $V_{\text{abn}} = \underline{\hspace{2cm}}$ 

Where applicable values are unobtainable, they can be estimated and entered while programming.

Programming

Note:

Security must be disabled to set programming functions.

Calibration: 0 - 100% / 4 - 20 mA

- calibrate the 0% / 4 or 20 mA level by entering the value of V_{norm} into P 2.
- calibrate the 100% / 20 or 4 mA level by entering the value of V_{abn} into P 3. The difference between P 2 and P 3 must be at least 0.2 V for full 4 - 20 mA span.

Relays

For precise determination of alarm setpoints, view the run display in percent and run the material or machinery through its range of operation. Note the % values corresponding to the alarm points.

Note:

The setpoints should be 0.50 V above or below the fault/no fault condition if the sensor is installed in high RF noise locations.

Relay 1

- enable, P10 = 1
- setpoint:
 - for high% alarm,*
 - P11 = enter setpoint value in %
 - P12 = 0
 - for low% alarm,*
 - P11 = 0
 - P12 = enter setpoint value in %
 - for out of bound alarm,*
 - P11 = enter high% setpoint value in %
 - P12 = enter low% setpoint value in %
 - for in bound alarm,*
 - P11 = enter low% setpoint value in %
 - P12 = enter high% setpoint value in %
- relay delay set (1 - 999 s), P13

- reset select, P14
auto = 0
manual = 1

Relay 2

- enable, P20 = 1
- setpoint:
for high% alarm,
P21 = enter setpoint value in %
P22 = 0
for low% alarm,
P21 = 0
P22 = enter setpoint value in %
for out of bound alarm,
P21 = enter high% setpoint value in %
P22 = enter low% setpoint value in %
for in bound alarm,
P21 = enter low% setpoint value in %
P22 = enter high% setpoint value in %
- relay delay set (1 - 999 s), P23
- reset select, P24
auto = 0
manual = 1

Ancillary Functions

Damping

- mA output damping adjust (typical value, 1 - 50), P85
- display damping adjust (typical value, 1 - 50), P86

Parameter List

P- 1	security, reference = 500 ^f
P- 2	0% calibration / 4 mA ($V_{\text{sens}} = 0 - 7.3 \text{ V}$) ^{f=0.50}
P- 3	100% calibration / 20 mA ($V_{\text{sens}} = 0.2 - 7.5 \text{ V}$) ^{f=2.50}
P-10	relay 1, operation: 0 = disabled ^f 1 = enabled
P-11*	relay 1, high alarm setpoint (0 = disabled, 1 to 100%) ^f = 80
P-12*	relay 1, low alarm setpoint (0 = disabled, 1 to 100%) ^f = 20
P-13*	relay 1, delay (1 ^f to 999 s)
P-14*	relay 1, latch: 0 = auto reset ^f 1 = manual reset
P-20	relay 2, operation: 0 = disabled ^f 1 = enabled
P-21*	relay 2, high alarm setpoint (0 = disabled, 1 to 100%) ^f = 70
P-22*	relay 2, low alarm setpoint (0 = disabled, 1 to 100%) ^f = 30
P-23*	relay 2, delay (1 ^f to 999 s)
P-24*	relay 2, latch: 0 = auto reset ^f 1 = manual reset
P-80	start delay (1 to 999 s) ^{f=10}
P-85	damping, mA out (1 ^f to 999)
P-86	damping, display (1 ^f to 999)
P-90	software revision number
P-99	reset: 0 = normal ^f 9 = reset

^f factory setting

* accessible only if relay operation function is enabled

Security Alteration

	Press	Display	
To Enable Security:			security disabled, programming access granted
			reference value
			enable code
			security enabled, programming access denied
To Disable Security:			security enabled, programming access denied
			reference value
			disable code
			security disabled, programming access granted

Maintenance

CU-02 requires no maintenance, however a program of periodic checks is recommended.

www.milltronics.com

MILLTRONICS

Siemens Milltronics Process Instruments Inc.
1954 Technology Drive, P.O. Box 4225
Peterborough, ON, Canada K9J 7B1
Tel: (705) 745-2431 Fax: (705) 741-0466
www.milltronics.com

© Siemens Milltronics Process Instruments Inc. 2000
Subject to change without prior notice



7 M L 1 9 9 8 1 D N 0 1

Printed in Canada